

ABB industrial drives

# Firmware manual ACS880 primary control program



Power and productivity  
for a better world™



# List of related manuals

## \*Lists of hyperlinks to product manuals

|   | Code                            |
|---|---------------------------------|
| <i>ACS880-01 drives</i>                                       | <a href="#">9AKK105408A7004</a> |
| <i>ACS880-04 drive modules (200 to 710 kW, 300 to 700 hp)</i> | <a href="#">9AKK105713A4819</a> |
| <i>ACS880-07 drives (45 to 710 kW, 50 to 700 hp)</i>          | <a href="#">9AKK105408A8149</a> |
| <i>ACS880-07 drives (560 to 2800 kW)</i>                      | <a href="#">9AKK105713A6663</a> |
| <i>ACS880-17 drives (132 to 355 kW)</i>                       | <a href="#">9AKK106930A3466</a> |
| <i>ACS880-17 drives (160 to 3200 kW)</i>                      | <a href="#">9AKK106354A1499</a> |
| <i>ACS880-37 drives (132 to 355 kW)</i>                       | <a href="#">9AKK106930A3467</a> |
| <i>ACS880-37 drives (160 to 3200 kW)</i>                      | <a href="#">9AKK106354A1500</a> |

## Other drive hardware manuals

|   |                                 |
|---|---------------------------------|
| <i>ACS880-04XT drive module packages (500 to 1200 kW) hardware manual</i> | <a href="#">3AXD50000025169</a> |
| <i>ACS880-04 single drive module packages hardware manual</i>             | <a href="#">3AUA0000138495</a>  |
| <i>ACS880-14 and -34 single drive packages hardware manual</i>            | <a href="#">3AXD50000022021</a> |
| <i>ACS880-104 inverter modules hardware manual</i>                        | <a href="#">3AUA0000104271</a>  |
| <i>ACS880-107 inverter units hardware manual</i>                          | <a href="#">3AUA0000102519</a>  |

## Drive firmware manuals and guides

|   |                                 |
|---|---------------------------------|
| <i>ACS880 primary control program firmware manual</i>                   | <a href="#">3AUA0000085967</a>  |
| <i>ACS880 drives with primary control program, quick start-up guide</i> | <a href="#">3AUA0000098062</a>  |
| <i>Adaptive programming application guide</i>                           | <a href="#">3AXD50000028574</a> |
| <i>Drive application programming manual (IEC 61131-3)</i>               | <a href="#">3AUA0000127808</a>  |

## Option manuals and guides

|  |                                |
|--|--------------------------------|
| <i>ACX-AP-x assistant control panels user's manual</i>   | <a href="#">3AUA0000085685</a> |
| <i>Drive composer Start-up and maintenance PC tool User's manual</i>                                   | <a href="#">3AUA0000094606</a> |
| <i>Manuals and quick guides for I/O extension modules, fieldbus adapters, encoder interfaces, etc.</i> |                                |

You can find manuals and other product documents in PDF format on the Internet. See section [Document library on the Internet](#) on the inside of the back cover. For manuals not available in the Document library, contact your local ABB representative.

\*Available in the Document library.

# Firmware manual

ACS880 primary control program

Table of contents





# Table of contents

---

|                               |   |
|-------------------------------|---|
| List of related manuals ..... | 2 |
|-------------------------------|---|

## **1. Introduction to the manual**

|                                  |    |
|----------------------------------|----|
| What this chapter contains ..... | 11 |
| Applicability .....              | 11 |
| Safety instructions .....        | 11 |
| Target audience .....            | 11 |
| Contents of the manual .....     | 12 |
| Related documents .....          | 12 |
| Terms and abbreviations .....    | 13 |
| Cybersecurity disclaimer .....   | 15 |

## **2. Using the control panel**

## **3. Control locations and operating modes**

|  |    |
|--|----|
| What this chapter contains .....         | 19 |
| Local control vs. external control ..... | 20 |
| Local control .....                      | 20 |
| External control .....                   | 21 |
| Operating modes of the drive .....       | 22 |
| Speed control mode .....                 | 23 |
| Torque control mode .....                | 23 |
| Frequency control mode .....             | 23 |
| Special control modes .....              | 23 |

## **4. Program features**

|   |    |
|---|----|
| What this chapter contains .....              | 25 |
| Drive configuration and programming .....     | 26 |
| Programming via parameters .....              | 26 |
| Adaptive programming .....                    | 27 |
| Application programming .....                 | 27 |
| Control interfaces .....                      | 28 |
| Programmable analog inputs .....              | 28 |
| Programmable analog outputs .....             | 28 |
| Programmable digital inputs and outputs ..... | 28 |
| Programmable relay outputs .....              | 29 |
| Programmable I/O extensions .....             | 29 |
| Fieldbus control .....                        | 30 |
| Master/follower functionality .....           | 31 |
| External controller interface .....           | 38 |
| Control of a supply unit (LSU) .....          | 40 |
| Motor control .....                           | 42 |
| Direct torque control (DTC) .....             | 42 |
| Reference ramping .....                       | 42 |

---



## 6 Table of contents

|  |    |
|--|----|
| Constant speeds/frequencies                    | 43 |
| Critical speeds/frequencies                    | 43 |
| Speed controller autotune                      | 44 |
| Oscillation damping                            | 47 |
| Resonance frequency elimination                | 48 |
| Rush control                                   | 48 |
| Encoder support                                | 49 |
| Jogging  | 55 |
| Scalar motor control                           | 58 |
| Autophasing                                    | 59 |
| Flux braking                                   | 62 |
| DC magnetization                               | 63 |
| Hexagonal motor flux pattern                   | 65 |
| Application control                            | 66 |
| Application macros                             | 66 |
| Process PID control                            | 66 |
| Motor potentiometer                            | 69 |
| Mechanical brake control                       | 70 |
| DC voltage control                             | 75 |
| Overvoltage control                            | 75 |
| Undervoltage control (power loss ride-through) | 75 |
| Voltage control and trip limits                | 76 |
| Brake chopper                                  | 77 |
| Safety and protections                         | 79 |
| Emergency stop                                 | 79 |
| Motor thermal protection                       | 80 |
| Thermal protection of motor cable              | 83 |
| User load curve                                | 83 |
| Automatic fault resets                         | 84 |
| Other programmable protection functions        | 85 |
| Diagnostics                                    | 87 |
| Fault and warning messages, data logging       | 87 |
| Signal supervision                             | 87 |
| Maintenance timers and counters                | 87 |
| Energy saving calculators                      | 88 |
| Load analyzer                                  | 88 |
| Miscellaneous                                  | 90 |
| User parameter sets                            | 90 |
| Parameter checksum calculation                 | 90 |
| User lock                                      | 91 |
| Data storage parameters                        | 91 |
| Reduced run function                           | 92 |
| du/dt filter support                           | 93 |
| Sine filter support                            | 93 |

## 5. Application macros

|  |    |
|--|----|
| What this chapter contains                       | 95 |
| General  | 95 |
| Factory macro                                    | 96 |
| Default parameter settings for the Factory macro | 96 |

---

|  |     |
|--|-----|
| Default control connections for the Factory macro .....            | 97  |
| Hand/Auto macro .....  | 98  |
| Default parameter settings for the Hand/Auto macro .....           | 98  |
| Default control connections for the Hand/Auto macro .....          | 99  |
| PID control macro .....  | 100 |
| Default parameter settings for the PID control macro .....         | 101 |
| Default control connections for the PID control macro .....        | 102 |
| Sensor connection examples for the PID control macro .....         | 103 |
| Torque control macro .....   | 104 |
| Default parameter settings for the Torque control macro .....      | 104 |
| Default control connections for the Torque control macro .....     | 105 |
| Sequential control macro .....                                     | 106 |
| Operation diagram .....  | 106 |
| Selection of constant speeds .....                                 | 107 |
| Default parameter settings for the Sequential control macro .....  | 107 |
| Default control connections for the Sequential control macro ..... | 108 |
| Fieldbus control macro .....                                       | 109 |

## 6. Parameters

|                                       |     |
|---------------------------------------|-----|
| What this chapter contains .....      | 111 |
| Terms and abbreviations .....         | 112 |
| Summary of parameter groups .....     | 113 |
| Parameter listing .....               | 115 |
| 01 Actual values .....                | 115 |
| 03 Input references .....             | 119 |
| 04 Warnings and faults .....          | 120 |
| 05 Diagnostics .....                  | 127 |
| 06 Control and status words .....     | 128 |
| 07 System info .....                  | 143 |
| 10 Standard DI, RO .....              | 145 |
| 11 Standard DIO, FI, FO .....         | 152 |
| 12 Standard AI .....                  | 157 |
| 13 Standard AO .....                  | 161 |
| 14 I/O extension module 1 .....       | 165 |
| 15 I/O extension module 2 .....       | 184 |
| 16 I/O extension module 3 .....       | 188 |
| 19 Operation mode .....               | 192 |
| 20 Start/stop/direction .....         | 194 |
| 21 Start/stop mode .....              | 203 |
| 22 Speed reference selection .....    | 210 |
| 23 Speed reference ramp .....         | 218 |
| 24 Speed reference conditioning ..... | 224 |
| 25 Speed control .....                | 229 |
| 26 Torque reference chain .....       | 240 |
| 28 Frequency reference chain .....    | 246 |
| 30 Limits .....                       | 255 |
| 31 Fault functions .....              | 263 |
| 32 Supervision .....                  | 273 |
| 33 Generic timer & counter .....      | 276 |
| 35 Motor thermal protection .....     | 284 |



## 8 Table of contents

|                                |     |
|--------------------------------|-----|
| 36 Load analyzer               | 294 |
| 37 User load curve             | 298 |
| 40 Process PID set 1           | 301 |
| 41 Process PID set 2           | 313 |
| 43 Brake chopper               | 315 |
| 44 Mechanical brake control    | 317 |
| 45 Energy efficiency           | 321 |
| 46 Monitoring/scaling settings | 324 |
| 47 Data storage                | 328 |
| 49 Panel port communication    | 331 |
| 50 Fieldbus adapter (FBA)      | 333 |
| 51 FBA A settings              | 341 |
| 52 FBA A data in               | 342 |
| 53 FBA A data out              | 343 |
| 54 FBA B settings              | 343 |
| 55 FBA B data in               | 344 |
| 56 FBA B data out              | 345 |
| 58 Embedded fieldbus           | 345 |
| 60 DDCS communication          | 353 |
| 61 D2D and DDCS transmit data  | 366 |
| 62 D2D and DDCS receive data   | 370 |
| 90 Feedback selection          | 378 |
| 91 Encoder module settings     | 387 |
| 92 Encoder 1 configuration     | 390 |
| 93 Encoder 2 configuration     | 396 |
| 94 LSU control                 | 398 |
| 95 HW configuration            | 400 |
| 96 System                      | 405 |
| 97 Motor control               | 417 |
| 98 User motor parameters       | 421 |
| 99 Motor data                  | 423 |
| 200 Safety                     | 429 |

### 7. Additional parameter data

|                            |     |
|----------------------------|-----|
| What this chapter contains | 431 |
| Terms and abbreviations    | 431 |
| Fieldbus addresses         | 432 |
| Parameter groups 1...9     | 433 |
| Parameter groups 10...99   | 439 |

### 8. Fault tracing

|                                    |     |
|------------------------------------|-----|
| What this chapter contains         | 487 |
| Safety                             | 487 |
| Indications                        | 487 |
| Warnings and faults                | 487 |
| Pure events                        | 488 |
| Editable messages                  | 488 |
| Warning/fault history and analysis | 488 |
| Event logs                         | 488 |

---





|   |     |
|---|-----|
| Other data loggers .....                                | 489 |
| Parameters that contain warning/fault information ..... | 489 |
| QR Code generation for mobile service application ..... | 490 |
| Warning messages .....                                  | 491 |
| Fault messages .....                                    | 508 |

## **9. Fieldbus control through the embedded fieldbus interface (EFB)**

|  |     |
|--|-----|
| What this chapter contains .....                               | 527 |
| System overview .....  | 527 |
| Connecting the fieldbus to the drive .....                     | 528 |
| Setting up the embedded fieldbus interface .....               | 529 |
| Setting the drive control parameters .....                     | 530 |
| Basics of the embedded fieldbus interface .....                | 533 |
| Control word and Status word .....                             | 534 |
| References .....   | 534 |
| Actual values .....  | 534 |
| Data input/outputs .....                                       | 534 |
| Register addressing .....                                      | 535 |
| About the control profiles .....                               | 536 |
| The ABB Drives profile .....                                   | 537 |
| Control Word .....   | 537 |
| Status Word .....  | 539 |
| State transition diagram .....                                 | 540 |
| References .....   | 541 |
| Actual values .....  | 542 |
| Modbus holding register addresses .....                        | 543 |
| The Transparent profile .....                                  | 544 |
| Modbus function codes .....                                    | 545 |
| Exception codes .....  | 546 |
| Coils (0xxxx reference set) .....                              | 547 |
| Discrete inputs (1xxxx reference set) .....                    | 548 |
| Error code registers (holding registers 400090...400100) ..... | 550 |



## **10. Fieldbus control through a fieldbus adapter**

|  |     |
|--|-----|
| What this chapter contains .....                                 | 551 |
| System overview .....  | 551 |
| Basics of the fieldbus control interface .....                   | 553 |
| Control word and Status word .....                               | 554 |
| References .....   | 554 |
| Actual values .....  | 555 |
| Contents of the fieldbus Control word (ABB Drives profile) ..... | 557 |
| Contents of the fieldbus Status word (ABB Drives profile) .....  | 558 |
| The state diagram (ABB Drives profile) .....                     | 559 |
| Setting up the drive for fieldbus control .....                  | 560 |
| Parameter setting example: FPBA (PROFIBUS DP) .....              | 561 |

## **11. Control chain diagrams**

|                                  |     |
|----------------------------------|-----|
| What this chapter contains ..... | 563 |
|----------------------------------|-----|

|  |     |
|--|-----|
| Speed reference source selection I .....                 | 564 |
| Speed reference source selection II .....                | 565 |
| Speed reference ramping and shaping .....                | 566 |
| Motor feedback configuration .....                       | 567 |
| Load feedback and position counter configuration .....   | 568 |
| Speed error calculation .....                            | 569 |
| Speed controller .....                                   | 570 |
| Torque reference source selection and modification ..... | 571 |
| Operating mode selection .....                           | 572 |
| Reference selection for torque controller .....          | 573 |
| Torque limitation .....                                  | 574 |
| Torque controller .....                                  | 575 |
| Frequency reference selection .....                      | 576 |
| Frequency reference modification .....                   | 577 |
| Process PID setpoint and feedback source selection ..... | 578 |
| Process PID controller .....                             | 579 |
| Master/Follower communication I (Master) .....           | 580 |
| Master/Follower communication II (Follower) .....        | 581 |



**Further information**

|  |     |
|--|-----|
| Product and service inquiries .....            | 583 |
| Product training .....                         | 583 |
| Providing feedback on ABB Drives manuals ..... | 583 |
| Document library on the Internet .....         | 583 |

---



# Introduction to the manual

---

## What this chapter contains

This chapter describes the contents of the manual. It also contains information on the compatibility, safety and intended audience.

## Applicability

This manual applies to ACS880 primary control program version 2.6x.

The firmware version of the control program is visible in parameter [07.05 Firmware version](#), or the System info in the main menu on the drive control panel.

## Safety instructions

Follow all safety instructions delivered with the drive.

- Read the **complete safety instructions** before you install, commission, or use the drive. The complete safety instructions are delivered with the drive as either part of the *Hardware manual*, or, in the case of ACS880 multidrives, as a separate document.
- Read the **firmware function-specific warnings and notes** before changing parameter values. These warnings and notes are included in the parameter descriptions presented in chapter [Parameters](#).

## Target audience

This manual is intended for people who design, commission, or operate the drive system.

---

## Contents of the manual

This manual contains the following chapters:

- [Using the control panel](#) provides basic instructions for the use of the control panel.
- [Control locations and operating modes](#) describes the control locations and operating modes of the drive.
- [Program features](#) contains descriptions of the features of the ACS880 primary control program.
- [Application macros](#) contains a short description of each macro together with a connection diagram. Macros are pre-defined applications which will save the user time when configuring the drive.
- [Parameters](#) describes the parameters used to program the drive.
- [Additional parameter data](#) contains further information on the parameters.
- [Fault tracing](#) lists the warning and fault messages with possible causes and remedies.
- [Fieldbus control through the embedded fieldbus interface \(EFB\)](#) describes the communication to and from a fieldbus network using the embedded fieldbus interface of the drive.
- [Fieldbus control through a fieldbus adapter](#) describes the communication to and from a fieldbus network using an optional fieldbus adapter module.
- [Control chain diagrams](#) showing the parameter structure within the drive.

## Related documents

---

**Note:** A quick start-up sequence for a speed control application is provided by *ACS880 drives with primary control program, Quick start-up guide* (3AUA0000098062), delivered with the drive.

---

A list of related manuals is printed on the inside of the front cover.

---

## Terms and abbreviations

| Term/abbreviation | Definition   |
|-------------------|--|
| AC 800M           | Type of programmable controller manufactured by ABB.   |
| ACS800            | A product family of ABB drives   |
| ACS-AP-I          | Types of control panel used with ACS880 drives   |
| ACS-AP-W          |  |
| AI                | Analog input; interface for analog input signals   |
| AO                | Analog output; interface for analog output signals   |
| BCU               | Type of control unit used in ACS880 drives, primarily those with parallel-connected inverter or supply modules.  |
| D2D               | Drive-to-drive; communication link between drives that is implemented by application programming. See <i>Drive application programming manual (IEC 61131-3)</i> (3AUA0000127808 [English]).  |
| DC link           | DC circuit between rectifier and inverter  |
| DDCS              | Distributed drives communication system; a protocol used in communication between ABB drive equipment  |
| DI                | Digital input; interface for digital input signals   |
| DIO               | Digital input/output; interface that can be used as a digital input or output  |
| DO                | Digital output; interface for digital output signals   |
| Drive             | Frequency converter for controlling AC motors. The drive consists of a rectifier and an inverter connected together by the DC link. In drives up to approximately 500 kW, these are integrated into a single module (drive module). Larger drives typically consist of separate supply and inverter units. The ACS880 primary control program is used to control the inverter part of the drive. |
| DriveBus          | A communication link used by, for example, ABB controllers. ACS880 drives can be connected to the DriveBus link of the controller. See page <a href="#">38</a> .   |
| DTC               | Direct torque control. See page <a href="#">42</a> .   |
| EFB               | Embedded fieldbus interface. See page <a href="#">527</a> .  |
| FAIO-01           | Optional analog I/O extension module   |
| FBA               | Fieldbus adapter   |
| FCAN-01           | Optional CANopen adapter   |
| FCNA-01           | Optional ControlNet adapter  |
| FDCO-0x           | Optional DDCS communication module   |
| FDIO-01           | Optional digital I/O extension module  |
| FDNA-01           | Optional DeviceNet™ adapter  |
| FEA-03            | Optional I/O extension adapter   |
| FECA-01           | Optional EtherCAT® adapter   |
| FEN-01            | Optional TTL encoder interface module  |
| FEN-11            | Optional absolute encoder interface module   |

| Term/abbreviation    | Definition  |
|----------------------|---|
| FEN-21               | Optional resolver interface module  |
| FEN-31               | Optional HTL encoder interface module   |
| FENA-11              | Optional Ethernet/IP, Modbus/TCP and PROFINET IO adapter  |
| FENA-21              | Optional dual-port Ethernet/IP, Modbus/TCP and PROFINET IO adapter  |
| FEPL-02              | Optional POWERLINK adapter  |
| FIO-01               | Optional digital I/O extension module   |
| FIO-11               | Optional analog I/O extension module  |
| FPBA-01              | Optional PROFIBUS DP adapter  |
| FPTC-01              | Optional thermistor protection module.  |
| FPTC-02              | Optional ATEX-certified thermistor protection module for potentially explosive atmospheres.   |
| FSCA-01              | Optional Modbus/RTU adapter   |
| FSO-xx               | Optional safety functions module  |
| HTL                  | High-threshold logic  |
| ID run               | Motor identification run. During the identification run, the drive will identify the characteristics of the motor for optimum motor control.  |
| IGBT                 | Insulated gate bipolar transistor; a voltage-controlled semiconductor type widely used in inverters and IGBT supply units due to their easy controllability and high switching frequency  |
| INU-LSU              | Type of optical <i>DDCS</i> communication link between two converters, for example the <i>supply unit</i> and the <i>inverter unit</i> of a drive system.   |
| Inverter unit        | The part of the drive that converts DC to AC for the motor.   |
| I/O                  | Input/Output  |
| ISU                  | An IGBT supply unit; type of supply unit implemented using IGBT switching components, used in regenerative and low-harmonic drives.   |
| Line-side converter  | See <i>supply unit</i> .  |
| LSU                  | See <i>supply unit</i> .  |
| ModuleBus            | A communication link used by, for example, ABB controllers. ACS880 drives can be connected to the optical ModuleBus link of the controller.   |
| Motor-side converter | See <i>inverter unit</i> .  |
| Network control      | With fieldbus protocols based on the Common Industrial Protocol (CIP™), such as DeviceNet and Ethernet/IP, denotes the control of the drive using the Net Ctrl and Net Ref objects of the ODVA AC/DC Drive Profile. For more information, see <a href="http://www.odva.org">www.odva.org</a> , and the following manuals: <ul style="list-style-type: none"> <li>• <i>FDNA-01 DeviceNet adapter module User's manual</i> (3AFE68573360 [English]), and</li> <li>• <i>FENA-01/-11 Ethernet adapter module User's manual</i> (3AUA0000093568 [English]).</li> </ul> |

| Term/abbreviation | Definition   |
|-------------------|--|
| Parameter         | User-adjustable operation instruction to the drive, or signal measured or calculated by the drive  |
| PID controller    | Proportional–integral–derivative controller. Drive speed control is based on PID algorithm.  |
| PLC               | Programmable logic controller  |
| Power unit        | Contains the power electronics and power connections of the drive (or inverter module). The drive control unit is connected to the power unit.   |
| PTC               | Positive temperature coefficient   |
| PU                | See <a href="#">power unit</a> .   |
| RDCO-0x           | DDCS communication module  |
| RFG               | Ramp function generator.   |
| RO                | Relay output; interface for a digital output signal. Implemented with a relay.   |
| SSI               | Synchronous serial interface   |
| STO               | Safe torque off  |
| Supply unit       | The part of the drive that converts AC to DC. An IGBT supply unit ( <a href="#">ISU</a> ) is also capable of feeding regenerative energy back into the supply network.   |
| TTL               | Transistor-transistor logic  |
| UPS               | Uninterruptible power supply; power supply equipment with battery to maintain output voltage during power failure  |
| ZCU               | Type of control unit used in ACS880 drives (primarily in drive modules, or inverter/supply units consisting of a single power module). Consists of an I/O board built into a plastic housing.<br>Depending on the type of hardware, the control unit may be integrated into or fitted onto the drive/inverter module, or installed separately. |

## Cybersecurity disclaimer

This product is designed to be connected to and to communicate information and data via a network interface. It is Customer's sole responsibility to provide and continuously ensure a secure connection between the product and Customer network or any other network (as the case may be). Customer shall establish and maintain any appropriate measures (such as but not limited to the installation of firewalls, application of authentication measures, encryption of data, installation of anti-virus programs, etc) to protect the product, the network, its system and the interface against any kind of security breaches, unauthorized access, interference, intrusion, leakage and/or theft of data or information. ABB and its affiliates are not liable for damages and/or losses related to such security breaches, any unauthorized access, interference, intrusion, leakage and/or theft of data or information.

See also section [User lock](#) (page [91](#)).







# Using the control panel

---

Refer to *ACX-AP-x assistant control panels user's manual* (3AUA0000085685 [English]).





# Control locations and operating modes

---

## What this chapter contains

This chapter describes the control locations and operating modes supported by the control program.

---

## Local control vs. external control

The ACS880 has two main control locations: external and local. The control location is selected with the Loc/Rem key on the control panel or in the PC tool.

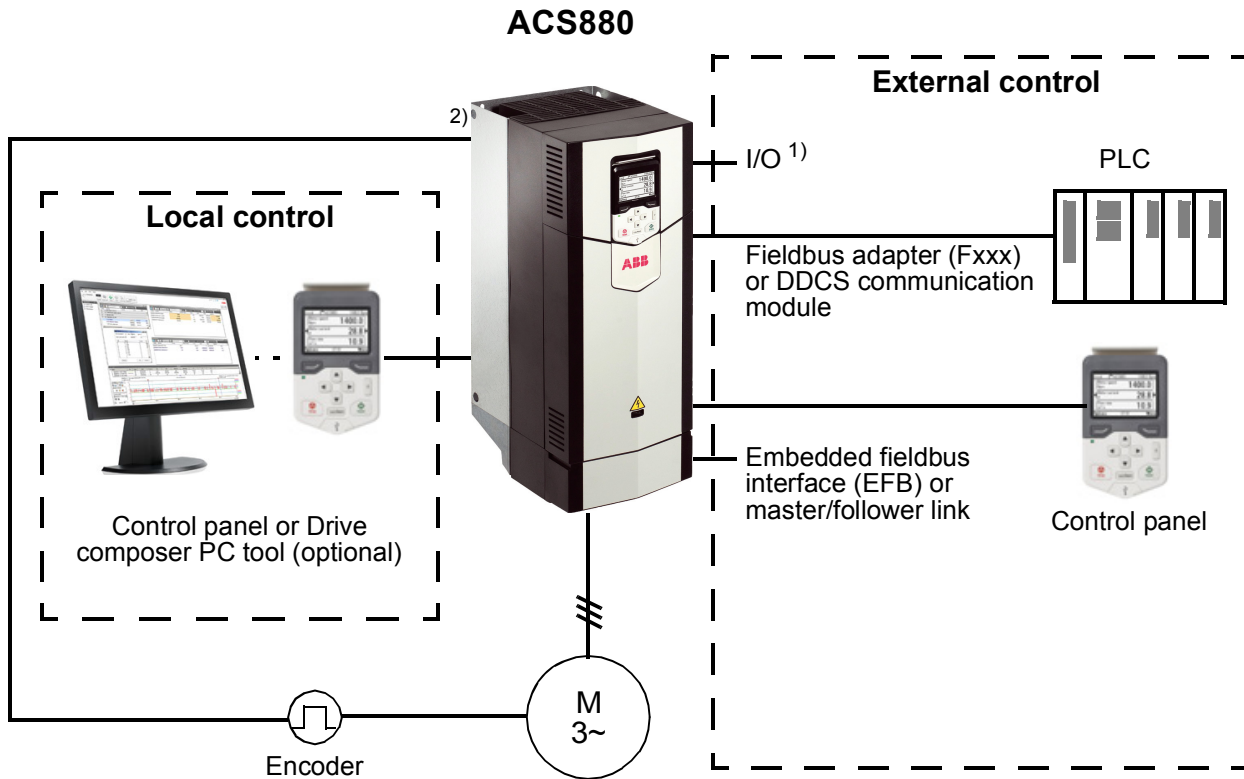

1) Extra inputs/outputs can be added by installing optional I/O extension modules (FIO-xx) in drive slots.

2) Encoder or resolver interface module(s) (FEN-xx) installed in drive slots.

### Local control

The control commands are given from the control panel keypad or from a PC equipped with Drive composer when the drive is set to local control. Speed and torque control modes are available for local control; frequency mode is available when scalar motor control mode is used (see parameter [19.16 Local control mode](#)).

Local control is mainly used during commissioning and maintenance. The control panel always overrides the external control signal sources when used in local control. Changing the control location to local can be prevented by parameter [19.17 Local control disable](#).

The user can select by a parameter ([49.05 Communication loss action](#)) how the drive reacts to a control panel or PC tool communication break. (The parameter has no effect in external control.)

## ■ External control

When the drive is in external control, control commands are given through

- the I/O terminals (digital and analog inputs), or optional I/O extension modules
- the embedded fieldbus interface or an optional fieldbus adapter module
- the external (DDCS) controller interface
- the master/follower link, and/or
- the control panel.

Two external control locations, EXT1 and EXT2, are available. The user can select the sources of the start and stop commands separately for each location by parameters [20.01](#)...[20.10](#). The operating mode can be selected separately for each location (in parameter group [19 Operation mode](#)), which enables quick switching between different operating modes, for example speed and torque control. Selection between EXT1 and EXT2 is done via any binary source such as a digital input or fieldbus control word (see parameter [19.11 Ext1/Ext2 selection](#)). The source of reference is selectable for each operating mode separately.

The control location selection is checked on a 2 ms time level.

### Using the control panel as an external control source

The control panel can also be used as a source of start/stop commands and/or reference in external control. Selections for the control panel are available in the start/stop command source and reference source selection parameters.

Reference source selection parameters (except PID setpoint selectors) have two selections for the control panel. The difference between the two selections is in the initial reference value after the reference source switches to the control panel.

The panel reference is saved whenever another reference source is selected. If the reference source selection parameter is set to [Control panel \(ref saved\)](#), the saved value is used as the initial reference when control switches back to the panel. Note that only one type of reference can be saved at a time: for example, attempting to use the same saved reference with different operating modes (speed, torque, etc.) causes the drive to trip on [7083 Panel reference conflict](#). The panel reference can be separately limited by parameters in group [49 Panel port communication](#).

With the reference source selection parameter set to [Control panel \(ref copied\)](#), the initial panel reference value depends on whether the operating mode changes with the reference source. If the source switches to the panel and the operating mode does not change, the last reference from the previous source is adopted. If the operating mode changes, the drive actual value corresponding to the new mode is adopted as the initial value.

The process PID setpoint selectors in parameter groups [40 Process PID set 1](#) and [41 Process PID set 2](#) only have one setting for the control panel. Whenever the control panel is selected as the setpoint source, operation resumes using the previous setpoint.

## Operating modes of the drive

The drive can operate in several operating modes with different types of reference. The mode is selectable for each control location (Local, EXT1 and EXT2) in parameter group [19 Operation mode](#).

The following is a general representation of the reference types and control chains. The page numbers refer to detailed diagrams in chapter [Control chain diagrams](#).

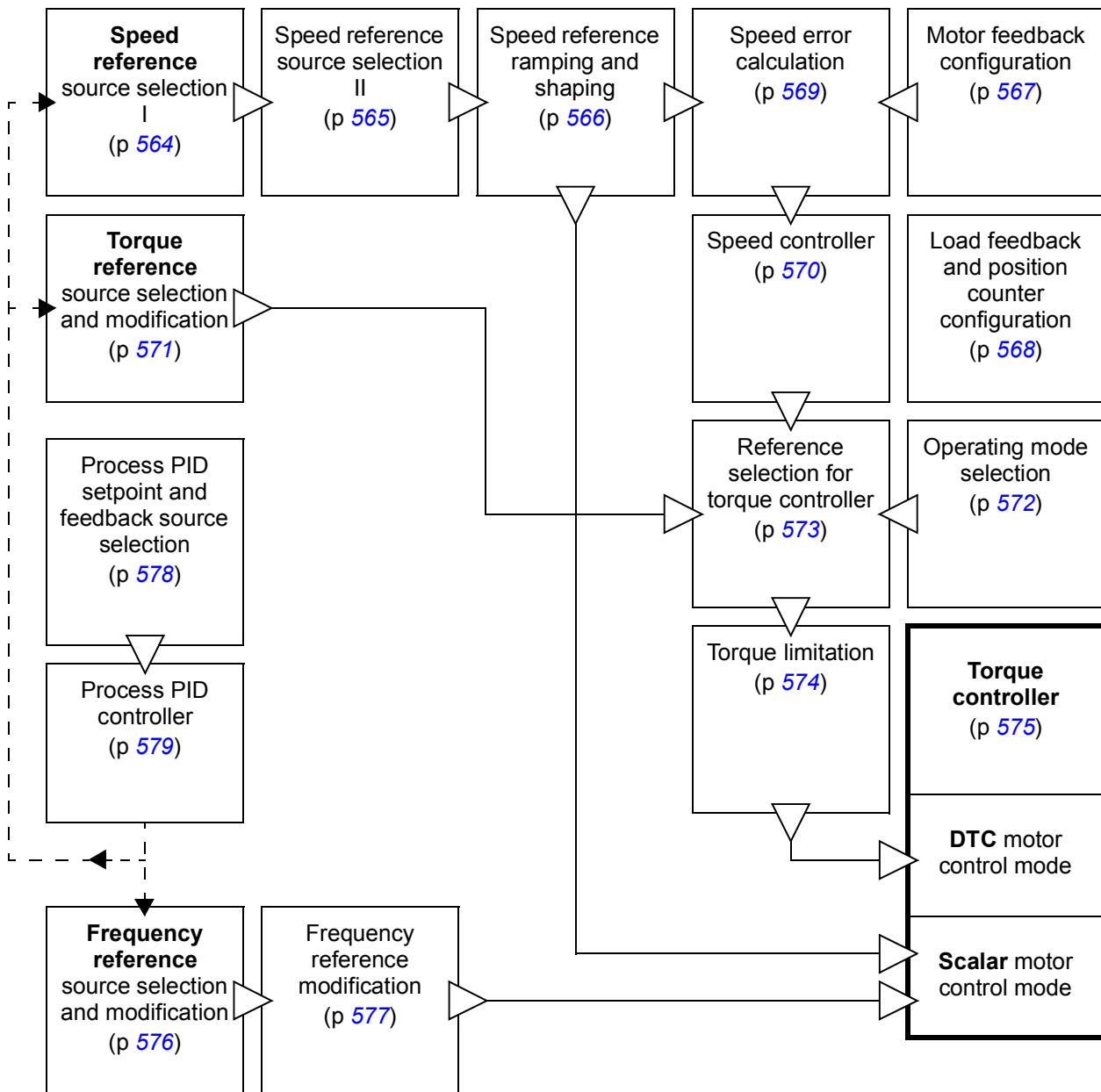

## ■ Speed control mode

The motor follows a speed reference given to the drive. This mode can be used either with estimated speed as feedback, or with an encoder or resolver for better speed control accuracy.

Speed control mode is available in both local and external control. It is also available both in DTC (Direct Torque Control) and scalar motor control modes.

## ■ Torque control mode

Motor torque follows a torque reference given to the drive. Torque control is possible without feedback, but is much more dynamic and accurate when used in conjunction with a feedback device such as an encoder or a resolver. It is recommended that a feedback device is used in crane, winch or lift control situations.

Torque control mode is available in DTC motor control mode for both local and external control locations.

## ■ Frequency control mode

The motor follows a frequency reference given to the drive. Frequency control is only available in scalar motor control mode.

## ■ Special control modes

In addition to the control modes mentioned above, the following special control modes are available:

- Process PID control. For more information, see section [Process PID control](#) (page 66).
  - Emergency stop modes Off1 and Off3: Drive stops along the defined deceleration ramp and drive modulation stops.
  - Jogging mode: Drive starts and accelerates to the defined speed when the jogging signal is activated. For more information, see section [Jogging](#) (page 55).
-







# Program features

---

## What this chapter contains

The control program contains all of the parameters (including actual signals) within the drive. This chapter describes some of the more important functions within the control program, how to use them and how to program them to operate.



**WARNING!** Make sure that the machinery into which the drive is integrated fulfils the personnel safety regulations. Note that the frequency converter (a Complete Drive Module or a Basic Drive Module, as defined in IEC 61800-2), is not considered as a safety device mentioned in the European Machinery Directive and related harmonized standards. Thus, the personnel safety of the complete machinery must not be based on a specific frequency converter feature, but it has to be implemented as defined in the application specific regulations.

---

## Drive configuration and programming

The drive control program is divided into two parts:

- firmware program
- application program.

### Drive control program

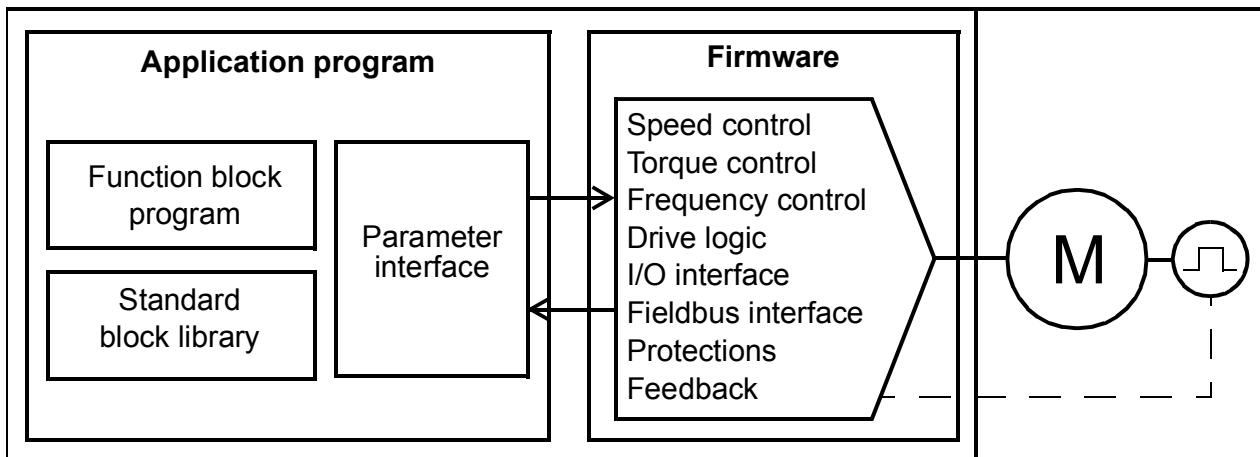

The firmware program performs the main control functions, including speed and torque control, drive logic (start/stop), I/O, feedback, communication and protection functions. Firmware functions are configured and programmed with parameters, and can be extended by application programming.

### ■ Programming via parameters

Parameters configure all of the standard drive operations and can be set via

- the control panel, as described in chapter [Using the control panel](#)
- the Drive composer PC tool, as described in *Drive composer user's manual* (3AUA0000094606 [English]), or
- the fieldbus interface, as described in chapters [Fieldbus control through the embedded fieldbus interface \(EFB\)](#) and [Fieldbus control through a fieldbus adapter](#).

All parameter settings are stored automatically to the permanent memory of the drive. However, if an external +24 V DC power supply is used for the drive control unit, it is highly recommended to force a save by using parameter [96.07 Parameter save manually](#) before powering down the control unit after any parameter changes have been made.

If necessary, the default parameter values can be restored by parameter [96.06 Parameter restore](#).

## ■ Adaptive programming

Conventionally, the user can control the operation of the drive by parameters. However, the standard parameters have a fixed set of choices or a setting range. To further customize the operation of the drive, an adaptive program can be constructed out of a set of function blocks.

The Drive composer pro PC tool (version 1.10 or later, available separately) has an Adaptive programming feature with a graphical user interface for building the custom program. The function blocks include the usual arithmetic and logical functions, as well as eg. selection, comparison and timer blocks. The program can contain a maximum of 20 blocks. The adaptive program is executed on a 10 ms time level.

For selecting input to the program, the user interface has pre-selections for the physical inputs, common actual values, and other status information of the drive. Parameter values as well as constants can also be defined as inputs. The output of the program can be used eg. as a start signal, external event or reference, or connected to the drive outputs. Note that connecting the output of the adaptive program to a selection parameter will write-protect the parameter.

The status of the adaptive program is shown by parameter [07.30 Adaptive program status](#). The adaptive program can be disabled by [96.70 Disable adaptive program](#).

For more information, see the *Adaptive programming application guide* (3AXD50000028574 [English]).

## ■ Application programming

The functions of the firmware program can be extended with application programming. Application programmability is available as option +N8010.

Application programs can be built out of function blocks based on the IEC 61131-3 standard using a PC tool available separately.

For more information, see *Programming manual: Drive application programming (IEC 61131-3)* (3AUA0000127808 [English]).

---

## Control interfaces

### ■ Programmable analog inputs

The control unit has two programmable analog inputs. Each of the inputs can be independently set as a voltage (0/2...10 V or -10...10 V) or current (0/4...20 mA) input by a jumper or switch on the control unit. Each input can be filtered, inverted and scaled. The analog inputs on the control unit are read on a 0.5 ms time level.

The number of analog inputs can be increased by installing FIO-11 or FAIO-01 I/O extensions (see [Programmable I/O extensions](#) below). The analog inputs on extension modules are read on a 2 ms time level.

The drive can be set to perform an action (for example, to generate a warning or fault) if the value of an analog input moves out of a predefined range.

### Settings

Parameter group [12 Standard AI](#) (page [157](#)).

### ■ Programmable analog outputs

The control unit has two current (0...20 mA) analog outputs. Each output can be filtered, inverted and scaled. The analog outputs on the control unit are updated on a 0.5 ms time level.

The number of analog outputs can be increased by installing FIO-11 or FAIO-01 I/O extensions (see [Programmable I/O extensions](#) below). The analog outputs on extension modules are updated on a 2 ms time level.

### Settings

Parameter group [13 Standard AO](#) (page [161](#)).

### ■ Programmable digital inputs and outputs

The control unit has six digital inputs, a digital start interlock input, and two digital input/outputs (I/O that can be set as either an input or an output). The digital inputs on the control unit are read on a 0.5 ms time level.

One digital input (DI6) doubles as a PTC thermistor input. See section [Motor thermal protection](#) (page [80](#)).

Digital input/output DIO1 can be used as a frequency input, DIO2 as a frequency output.

The number of digital inputs/outputs can be increased by installing FIO-01, FIO-11 or FDIO-01 I/O extensions (see [Programmable I/O extensions](#) below). The digital inputs on extension modules are read on a 2 ms time level.

---

## Settings

Parameter groups [10 Standard DI, RO](#) (page 145) and [11 Standard DIO, FI, FO](#) (page 152).

### ■ Programmable relay outputs

The control unit has three relay outputs. The signal to be indicated by the outputs can be selected by parameters. The relay outputs on the control unit are updated on a 0.5 ms time level.

Relay outputs can be added by installing FIO-01 or FDIO-01 I/O extensions. The relay outputs on extension modules are updated on a 2 ms time level.

## Settings

Parameter group [10 Standard DI, RO](#) (page 145).

### ■ Programmable I/O extensions

Inputs and outputs can be added by using I/O extension modules. One to three modules can be mounted on the slots of the control unit. Slots can be added by connecting an FEA-03 I/O extension adapter.

The table below shows the number of I/O on the control unit as well as optional I/O extension modules.

| Location     | Digital inputs (DI) | Digital I/Os (DIO) | Analog inputs (AI) | Analog outputs (AO) | Relay outputs (RO) |
|--------------|---------------------|--------------------|--------------------|---------------------|--------------------|
| Control unit | 6 + DIIL            | 2                  | 2                  | 2                   | 3                  |
| FIO-01       | -                   | 4                  | -                  | -                   | 2                  |
| FIO-11       | -                   | 2                  | 3                  | 1                   | -                  |
| FAIO-01      | -                   | -                  | 2                  | 2                   | -                  |
| FDIO-01      | 3                   | -                  | -                  | -                   | 2                  |

Three I/O extension modules can be activated and configured using parameter groups 14...16.

**Note:** Each configuration parameter group contains parameters that display the values of the inputs on that particular extension module. These parameters are the only way of utilizing the inputs on I/O extension modules as signal sources. To connect to an input, choose the setting *Other* in the source selector parameter, then specify the appropriate value parameter (and bit, for digital signals) in group 14, 15 or 16.

## Settings

- Parameter groups [14 I/O extension module 1](#) (page 165), [15 I/O extension module 2](#) (page 184), [16 I/O extension module 3](#) (page 188).
- Parameter [60.41](#) (page 361).

## ■ Fieldbus control

The drive can be connected to several different automation systems through its fieldbus interfaces. See chapters [Fieldbus control through the embedded fieldbus interface \(EFB\)](#) (page 527) and [Fieldbus control through a fieldbus adapter](#) (page 551).

## Settings

Parameter groups [50 Fieldbus adapter \(FBA\)](#) (page 333), [51 FBA A settings](#) (page 341), [52 FBA A data in](#) (page 342), and [53 FBA A data out](#) (page 343), [54 FBA B settings](#) (page 343), [55 FBA B data in](#) (page 344), [56 FBA B data out](#) (page 345), and [58 Embedded fieldbus](#) (page 345).

---

## ■ Master/follower functionality

### General

The master/follower functionality can be used to link several drives together so that the load can be evenly distributed between the drives. This is ideal in applications where the motors are coupled to each other via gearing, chain, belt, etc.

The external control signals are typically connected to one drive only which acts as the master. The master controls up to 10 followers by sending broadcast messages over an electrical cable or fiber optic link. The master can read feedback signals from up to 3 selected followers.

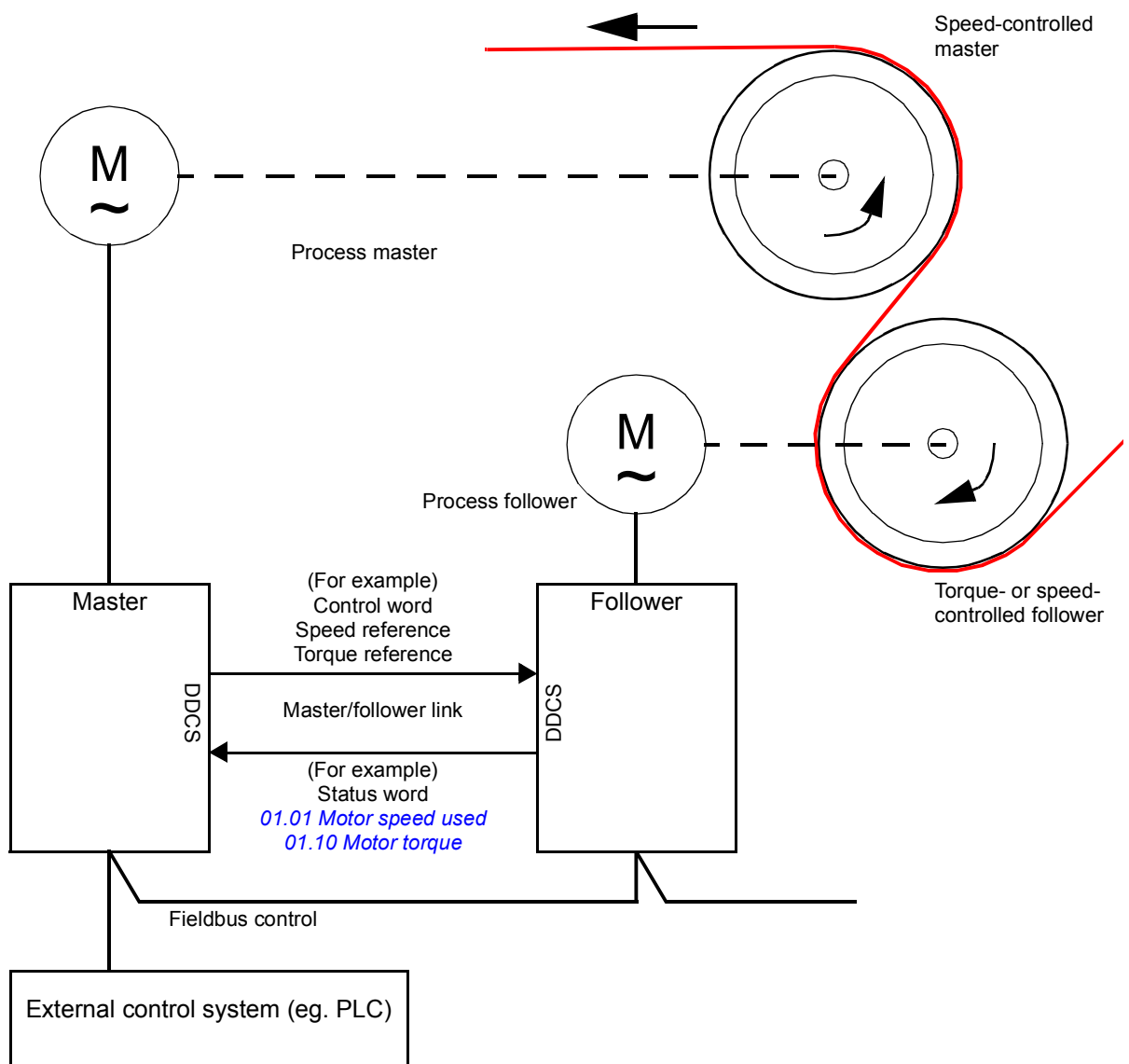

The master drive is typically speed-controlled and the other drives follow its torque or speed reference. In general, a follower should be

- torque-controlled when the motor shafts of the master and the follower are rigidly coupled by gearing, chain etc. so that no speed difference between the drives is possible
- speed-controlled when the motor shafts of the master and the follower are flexibly coupled so that a slight speed difference is possible. When both the master and the follower are speed-controlled, drooping is also typically used (see parameter [25.08 Drooping rate](#)). The distribution of load between the master and follower can alternatively be adjusted as described under [Load share function with a speed-controlled follower](#) below.

**Note:** With a speed-controlled follower (without load sharing), pay attention to the acceleration and deceleration ramp times of the follower. If the ramp times are set longer than in the master, the follower will follow its own acceleration/deceleration ramp times rather than those from the master. In general, it is recommended to set identical ramp times in both the master and the follower(s). Any ramp shape settings (see parameters [23.16...23.19](#)) should only be applied in the master.

In some applications, both speed control and torque control of the follower are required. In those cases, the operating mode can be switched by parameter ([19.12 Ext1 control mode](#) or [19.14 Ext2 control mode](#)). Another method is to set one external control location to speed control mode, the other to torque control mode. Then, a digital input of the follower can be used to switch between the control locations. See chapter [Control locations and operating modes](#) (page 19).

With torque control, follower parameter [26.15 Load share](#) can be used to scale the incoming torque reference for optimal load sharing between the master and the follower. Some torque-controlled follower applications, eg. where the torque is very low, or very low speed operation is required, may require encoder feedback.

If a drive needs to quickly switch between master and follower statuses, one user parameter set (see page 90) can be saved with the master settings, another with the follower settings. The suitable settings can then be activated using eg. digital inputs.

### Load share function with a speed-controlled follower

Load sharing between the master and a speed-controlled follower can be used in various applications. The load share function is implemented by fine-tuning the follower speed reference with an additional trim signal based on a torque reference. The torque reference is selected by parameter [23.42 Follower speed corr torq source](#) (by default, reference 2 received from the master). Load share is adjusted by parameter [26.15 Load share](#) and activated by the source selected by [23.40 Follower speed correction enable](#). Parameter [23.41 Follower speed correction gain](#) provides a gain adjustment for the speed correction. The final correction signal added to the speed reference is shown by [23.39 Follower speed correction out](#). See the block diagram on page 569.

---



**Notes:**

- The function can be enabled only when the drive is a speed-controlled follower in remote control mode.
- Drooping ([25.08 Drooping rate](#)) is ignored when the load share function is active.
- The master and follower should have the same speed control tuning values.
- The speed correction term is limited by the speed error window parameters [24.44 Speed error window low](#) and [24.43 Speed error window high](#). An active limitation is indicated by [06.19 Speed control status word](#).

**Communication**

A master/follower link can be built by connecting the drives together with fiber optic cables (may require additional equipment depending on existing drive hardware), or by wiring together the XD2D connectors of the drives. The medium is selected by parameter [60.01 M/F communication port](#).

Parameter [60.03 M/F mode](#) defines whether the drive is the master or a follower on the communication link. Typically, the speed-controlled process master drive is also configured as the master in the communication.

The communication on the master/follower link is based on the DDCS protocol, which employs data sets (specifically, data set 41). One data set contains three 16-bit words. The contents of the data set are freely configurable using parameters [61.01...61.03](#). The data set broadcast by the master typically contains the control word, speed reference and torque reference, while the followers return a status word with two actual values.

The default setting of parameter [61.01 M/F data 1 selection](#) is *Follower CW*. With this setting in the master, a word consisting of bits 0...11 of [06.01 Main control word](#) and four bits selected by parameters [06.45...06.48](#) is broadcast to the followers. However, bit 3 of the follower control word is modified so that it remains on as long as the master is modulating, and its switching to 0 causes the follower to coast to a stop. This is to synchronize the stopping of both master and follower.

**Note:** When the master is ramping down to a stop, the follower observes the decreasing reference but receives no stop command until the master stops modulating and clears bit 3 of the follower control word. Because of this, the maximum and minimum speed limits on the follower drive should not have the same sign – otherwise the follower would be pushing against the limit until the master finally stops.

Three words of additional data can optionally be read from each follower. The followers from which data is read are selected by parameter [60.14 M/F follower selection](#) in the master. In each follower drive, the data to be sent is selected by parameters [61.01...61.03](#). The data is transferred in integer format over the link, and displayed by parameters [62.28...62.36](#) in the master. The data can then be forwarded to other parameters using [62.04...62.12](#).

---

To indicate faults in the followers, each follower must be configured to transmit its status word as one of the above-mentioned data words. In the master, the corresponding target parameter must be set to *Follower SW*. The action to be taken when a follower is faulted is selected by *60.17 Follower fault action*. External events (see parameter group *31 Fault functions*) can be used to indicate the status of other bits of the status word.

Block diagrams of the master/follower communication are presented on pages [580](#) and [581](#).

### Construction of the master/follower link

The master/follower link is formed by connecting the drives together using either

- shielded twisted-pair cable between the XD2D terminals of the drives\*, or
- fiber optic cables. Drives with a *ZCU* control unit require an additional FDCO DDCS communication module; drives with a *BCU* control unit require an RDCO module.

\*This connection cannot co-exist with, and is not to be confused with, drive-to-drive (D2D) communication implemented by application programming (detailed in *Drive application programming manual (IEC 61131-3)*, 3AUA0000127808 [English]).

Connection examples are shown below. Note that a star configuration using fiber optic cables requires an NDBU-95C DDCS branching unit.

#### Master/follower wiring with electrical cable

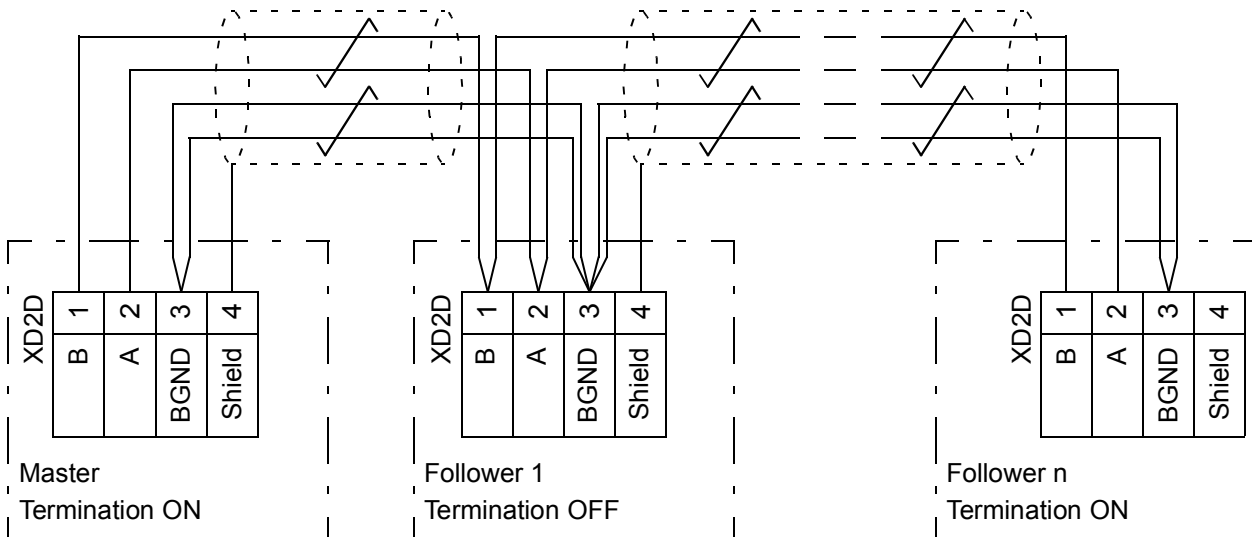

See the hardware manual of the drive for wiring and termination details.

*Ring configuration with fiber optic cables*

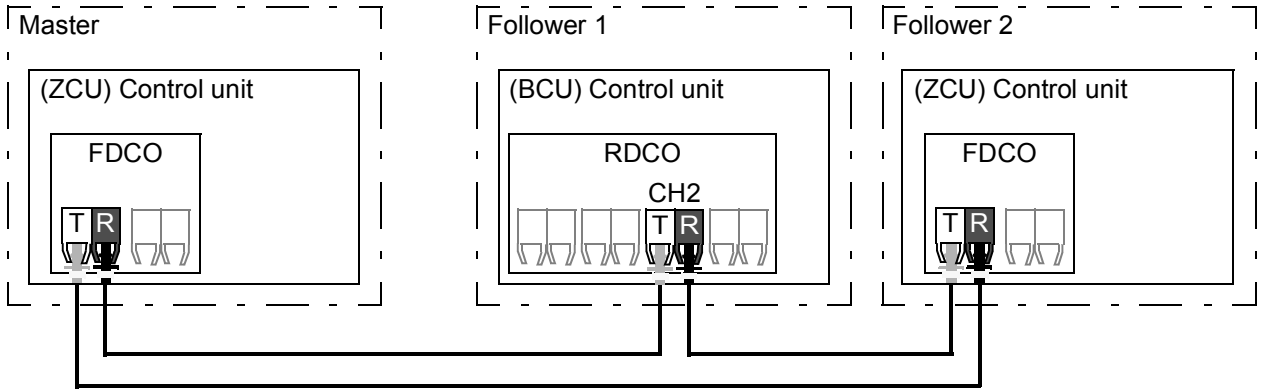

T = Transmitter; R = Receiver

*Star configuration with fiber optic cables (1)*

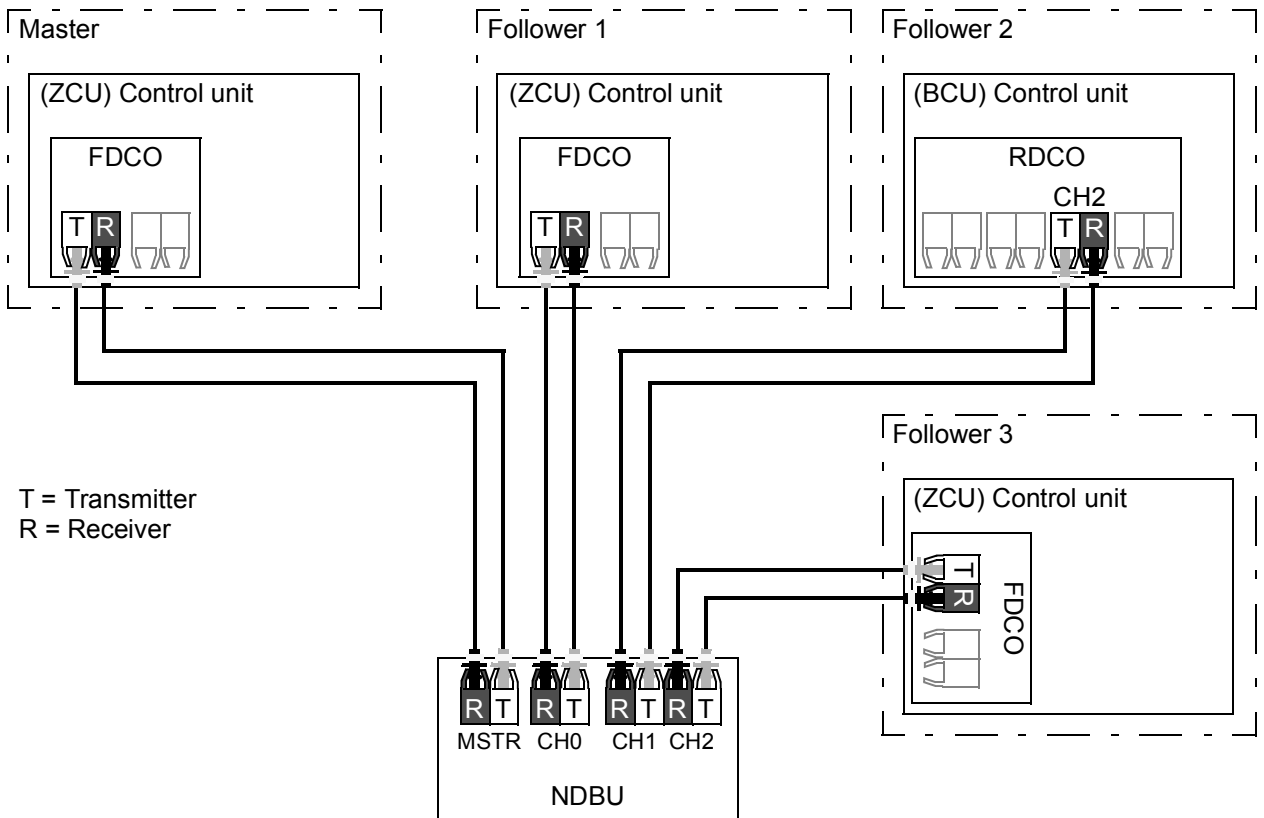

T = Transmitter  
R = Receiver

### Star configuration with fiber optic cables (2)

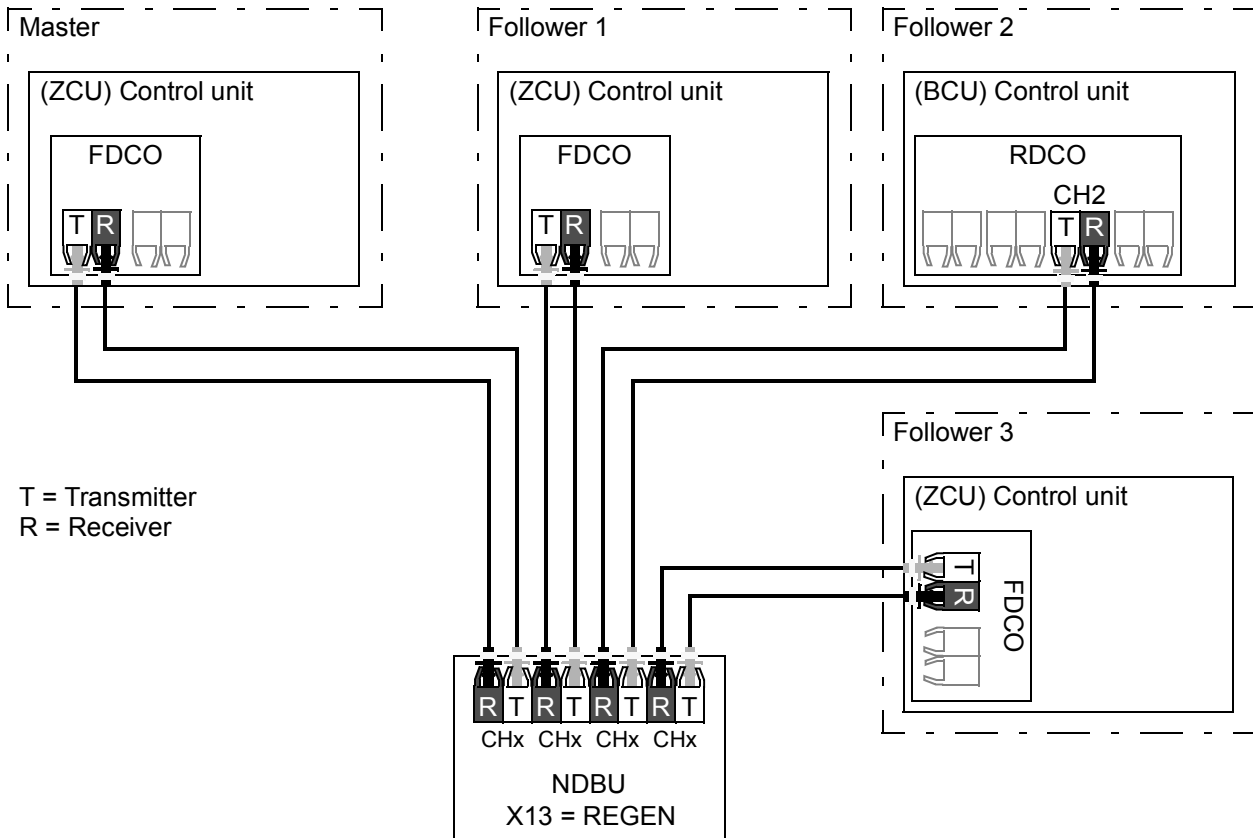

### Example parameter settings

The following is a checklist of parameters that need to be set when configuring the master/follower link. In this example, the master broadcasts the Follower control word, a speed reference and a torque reference. The follower returns a status word and two actual values (this is not compulsory but is shown for clarity).

#### Master settings:

- Master/follower link activation
  - [60.01 M/F communication port](#) (fiber optic channel or XD2D selection)
  - [\(60.02 M/F node address = 1\)](#)
  - [60.03 M/F mode = DDCS master](#) (for both fiber optic and wire connection)
  - [60.05 M/F HW connection](#) (*Ring* or *Star* for fiber optic, *Star* for wire)
- Data to be broadcast to the followers
  - [61.01 M/F data 1 selection = Follower CW](#) (Follower control word)
  - [61.02 M/F data 2 selection = Used speed reference](#)
  - [61.03 M/F data 3 selection = Torque reference act 5](#)
- Data to be read from the followers (optional)
  - [60.14 M/F follower selection](#) (selection of followers that data is read from)
  - [62.04 Follower node 2 data 1 sel ... 62.12 Follower node 4 data 3 sel](#) (mapping of data received from followers)

**Follower settings:**

- Master/follower link activation
  - [60.01 M/F communication port](#) (fiber optic channel or XD2D selection)
  - [60.02 M/F node address](#) = 2...60
  - [60.03 M/F mode](#) = *DDCS follower* (for both fiber optic and wire connection)
  - [60.05 M/F HW connection](#) (*Ring* or *Star* for fiber optic, *Star* for wire)
- Mapping of data received from master
  - [62.01 M/F data 1 selection](#) = *CW 16bit*
  - [62.02 M/F data 2 selection](#) = *Ref1 16bit*
  - [62.03 M/F data 3 selection](#) = *Ref2 16bit*
- Selection of operating mode and control location
  - [19.12 Ext1 control mode](#) = *Speed* or *Torque*
  - [20.01 Ext1 commands](#) = *M/F link*
  - [20.02 Ext1 start trigger type](#) = *Level*
- Selection of reference sources
  - [22.11 Speed ref1 source](#) = *M/F reference 1*
  - [26.11 Torque ref1 source](#) = *M/F reference 2*
- Selection of data to be sent to master (optional)
  - [61.01 M/F data 1 selection](#) = *SW 16bit*
  - [61.02 M/F data 2 selection](#) = *Act1 16bit*
  - [61.03 M/F data 3 selection](#) = *Act2 16bit*

**Specifications of the fiber optic master/follower link**

- Maximum fiber optic cable length:
  - FDCO-01/02 or RDCO-04 with POF (Plastic Optic Fiber): 30 m
  - FDCO-01/02 or RDCO-04 with HCS (Hard-clad Silica Fiber): 200 m
  - For distances up to 1000 m, use two NOCR-01 optical converter/repeaters with glass optic cable (GOF, 62.5 micrometers, Multi-Mode)
- Maximum shielded twisted-pair cable length: 50 m
- Transmission rate: 4 Mbit/s
- Total performance of the link: < 5 ms to transfer references between the master and followers.
- Protocol: DDCS (Distributed Drives Communication System)

**Settings and diagnostics**

Parameter groups [60 DDCS communication](#) (page 353), [61 D2D and DDCS transmit data](#) (page 366) and [62 D2D and DDCS receive data](#) (page 370).

---

## External controller interface

### General

The drive can be connected to an external controller (such as the ABB AC 800M) using either fiber optic or twisted-pair cable. The ACS880 is compatible with both the ModuleBus and DriveBus connections. Note that some features of DriveBus (such as BusManager) are not supported.

### Topology

An example connection with either a ZCU-based or BCU-based drive using fiber optic cables is shown below.

Drives with a **ZCU** control unit require an additional FDCO DDCS communication module; drives with a **BCU** control unit require an RDCO or FDCO module. The BCU has a dedicated slot for the RDCO – an FDCO module can also be used with a BCU control unit but it will reserve one of the three universal option module slots. Ring and star configurations are also possible much in the same way as with the master/follower link (see section [Master/follower functionality](#) on page 31); the notable difference is that the external controller connects to channel CH0 on the RDCO module instead of CH2. The channel on the FDCO communication module can be freely selected.

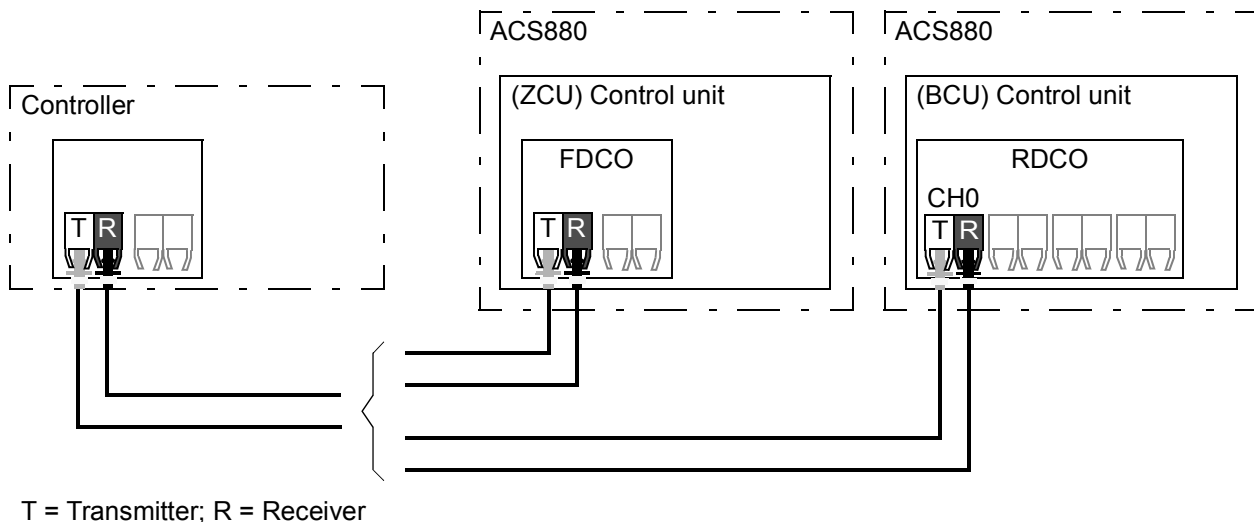

The external controller can also be wired to the D2D (RS-485) connector using shielded, twisted-pair cable. The selection of the connection is made by parameter [60.51 DDCS controller comm port](#).

The transfer rate can be selected by parameter [60.56 DDCS controller baud rate](#).

### Communication

The communication between the controller and the drive consists of data sets of three 16-bit words each. The controller sends a data set to the drive, which returns the next data set to the controller.



## ■ Control of a supply unit (LSU)

### General

With drives that consist of a supply unit and one inverter unit, the supply unit can be controlled through the inverter unit. (In drive systems consisting of multiple inverter units, this feature is not typically used.) For example, the inverter unit can send a control word and references to the supply unit, enabling the control of both units from the interfaces of one control program.

For more information, refer to the firmware manual of the other converter.

### Topology

The control units of the supply unit and the inverter unit are connected by fiber optic cables. With BCU-x2 control units equipped with RDCO modules, CH1 of the inverter is connected to CH0 of the supply unit.

An example connection with a BCU-based drive system is shown below.

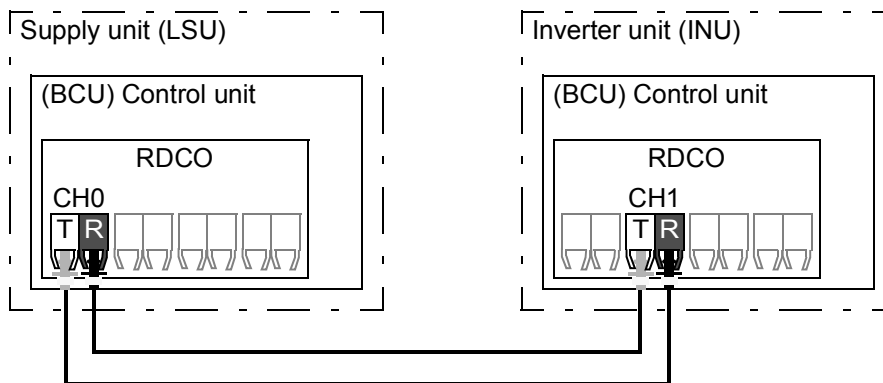

T = Transmitter; R = Receiver

With single drives consisting of separate supply and inverter units, the connection is factory-wired.

The fiber optic link specifications stated under [Specifications of the fiber optic master/follower link](#) (page 37) apply.

### Communication

The communication between the converters and the drive consists of data sets of three 16-bit words each. The inverter unit sends a data set to the supply unit, which returns the next data set to the inverter unit.

The communication uses data sets 10 and 11, updated at 2 ms intervals. Data set 10 is sent by the inverter unit to the supply unit, while data set 11 is sent by the supply unit to the inverter unit. The contents of the data sets are freely configurable, but data set 10 typically contains the control word, while data set 11 returns the status word.



With ACS880 single drives with a separately-controlled supply unit, the basic communication is initialized by parameter [95.20 HW options word 1](#). This will make several parameters visible (see below).

If the supply unit is regenerative (such as an IGBT supply unit), it is possible to send a DC voltage and/or reactive power reference to it from inverter parameter group [94 LSU control](#). A regenerative supply unit will also send actual signals to the inverter unit which are visible in parameter group [01 Actual values](#).

## Settings

- Parameters [01.102...01.164](#) (page [118](#)), [05.111...05.121](#) (page [128](#)), [06.36...06.43](#) (page [136](#)), [06.116...06.118](#) (page [142](#)), [07.106...07.107](#) (page [145](#)), [30.101...30.149](#) (page [261](#)), [31.120...31.121](#) (page [273](#)), [95.20 HW options word 1](#) (page [404](#)) and [96.108 LSU control board boot](#) (page [416](#)).
  - Parameter groups [60 DDCS communication](#) (page [353](#)), [61 D2D and DDCS transmit data](#) (page [366](#)), [62 D2D and DDCS receive data](#) (page [370](#)) and [94 LSU control](#) (page [398](#)).
-

## Motor control

### ■ Direct torque control (DTC)

The motor control of the ACS880 is based on direct torque control (DTC), the ABB premium motor control platform. The switching of the output semiconductors is controlled to achieve the required stator flux and motor torque. The switching frequency is changed only if the actual torque and stator flux values differ from their reference values by more than the allowed hysteresis. The reference value for the torque controller comes from the speed controller or directly from an external torque reference source.

Motor control requires measurement of the DC voltage and two motor phase currents. Stator flux is calculated by integrating the motor voltage in vector space. Motor torque is calculated as a cross product of the stator flux and the rotor current. By utilizing the identified motor model, the stator flux estimate is improved. Actual motor shaft speed is not needed for the motor control.

The main difference between traditional control and DTC is that torque control operates on the same time level as the power switch control. There is no separate voltage and frequency controlled PWM modulator; the output stage switching is wholly based on the electromagnetic state of the motor.

The best motor control accuracy is achieved by activating a separate motor identification run (ID run).

See also section [Scalar motor control](#) (page 58).

### Settings

Parameters [99.04 Motor control mode](#) (page 423) and [99.13 ID run requested](#) (page 426).

### ■ Reference ramping

Acceleration and deceleration ramping times can be set individually for speed, torque and frequency reference.

With a speed or frequency reference, the ramps are defined as the time it takes for the drive to accelerate or decelerate between zero speed or frequency and the value defined by parameter [46.01 Speed scaling](#) or [46.02 Frequency scaling](#). The user can switch between two preset ramp sets using a binary source such as a digital input. For speed reference, also the shape of the ramp can be controlled.

With a torque reference, the ramps are defined as the time it takes for the reference to change between zero and nominal motor torque (parameter [01.30 Nominal torque scale](#)).

---

## Special acceleration/deceleration ramps

The acceleration/deceleration times for the jogging function can be defined separately; see section [Jogging](#) (page 55).

The change rate of the motor potentiometer function (page 69) is adjustable. The same rate applies in both directions.

A deceleration ramp can be defined for emergency stop (“Off3” mode).

## Settings

- Speed reference ramping: Parameters [23.11](#)...[23.19](#) and [46.01](#) (pages [218](#) and [324](#)).
- Torque reference ramping: Parameters [01.30](#), [26.18](#) and [26.19](#) (pages [117](#) and [243](#)).
- Frequency reference ramping: Parameters [28.71](#)...[28.75](#) and [46.02](#) (pages [252](#) and [324](#)).
- Jogging: Parameters [23.20](#) and [23.21](#) (page [221](#)).
- Motor potentiometer: Parameter [22.75](#) (page [216](#)).
- Emergency stop (“Off3” mode): Parameter [23.23 Emergency stop time](#) (page [221](#)).

## ■ Constant speeds/frequencies

Constant speeds and frequencies are predefined references that can be quickly activated, for example, through digital inputs. It is possible to define up to 7 constant speeds for speed control and 7 constant frequencies for frequency control.



**WARNING:** Constant speeds and frequencies override the normal reference irrespective of where the reference is coming from.

---

The constant speeds/frequencies function operates on a 2 ms time level.

## Settings

Parameter groups [22 Speed reference selection](#) (page [210](#)) and [28 Frequency reference chain](#) (page [246](#)).

## ■ Critical speeds/frequencies

Critical speeds (sometimes called “skip speeds”) can be predefined for applications where it is necessary to avoid certain motor speeds or speed ranges because of, for example, mechanical resonance problems.

The critical speeds function prevents the reference from dwelling within a critical band for extended times. When a changing reference ([22.87 Speed reference act 7](#)) enters a critical range, the output of the function ([22.01 Speed ref unlimited](#)) freezes until the

---

reference exits the range. Any instant change in the output is smoothed out by the ramping function further in the reference chain.

The function is also available for scalar motor control with a frequency reference. The input of the function is shown by [28.96 Frequency ref act 7](#), the output by [28.97 Frequency ref unlimited](#).

### Example

A fan has vibrations in the range of 540 to 690 rpm and 1380 to 1560 rpm. To make the drive avoid these speed ranges,

- enable the critical speeds function by turning on bit 0 of parameter [22.51 Critical speed function](#), and
- set the critical speed ranges as in the figure below.

[22.01 Speed ref unlimited](#) (rpm)  
(output of function)

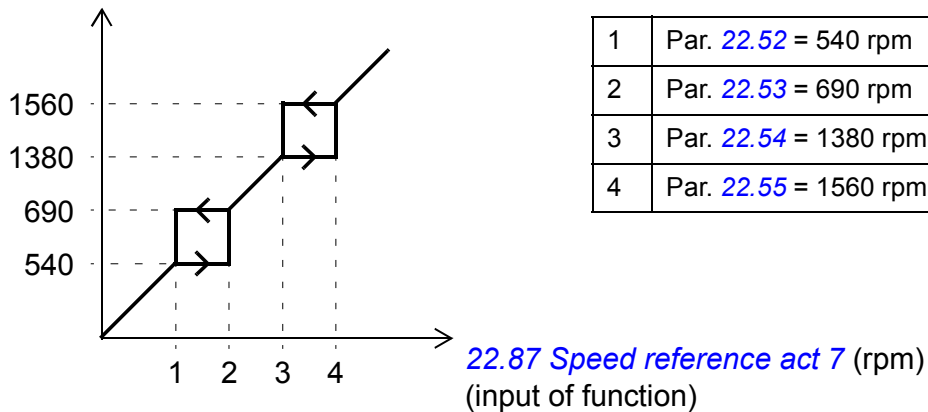

### Settings

- Critical speeds: parameters [22.51](#)...[22.57](#) (page [215](#))
- Critical frequencies: parameters [28.51](#)...[28.57](#) (page [251](#)).

### ■ Speed controller autotune

The speed controller of the drive can be automatically adjusted using the autotune function. Autotuning is based on an estimation of the mechanical time constant (inertia) of the motor and machine.

The autotune routine will run the motor through a series of acceleration/deceleration cycles, the number of which can be adjusted by parameter [25.40 Autotune repeat times](#). Higher values will produce more accurate results, especially if the difference between initial and maximum speeds is small.

The maximum torque reference used during autotuning will be the initial torque (ie. torque when the routine is activated) plus [25.38 Autotune torque step](#), unless limited by the maximum torque limit (parameter group [30 Limits](#)) or the nominal motor torque

([99 Motor data](#)). The calculated maximum speed during the routine is the initial speed (ie. speed when the routine is activated) + [25.39 Autotune speed step](#), unless limited by [30.12 Maximum speed](#) or [99.09 Motor nominal speed](#).

The diagram below shows the behavior of speed and torque during the autotune routine. In this example, [25.40 Autotune repeat times](#) is set to 2.

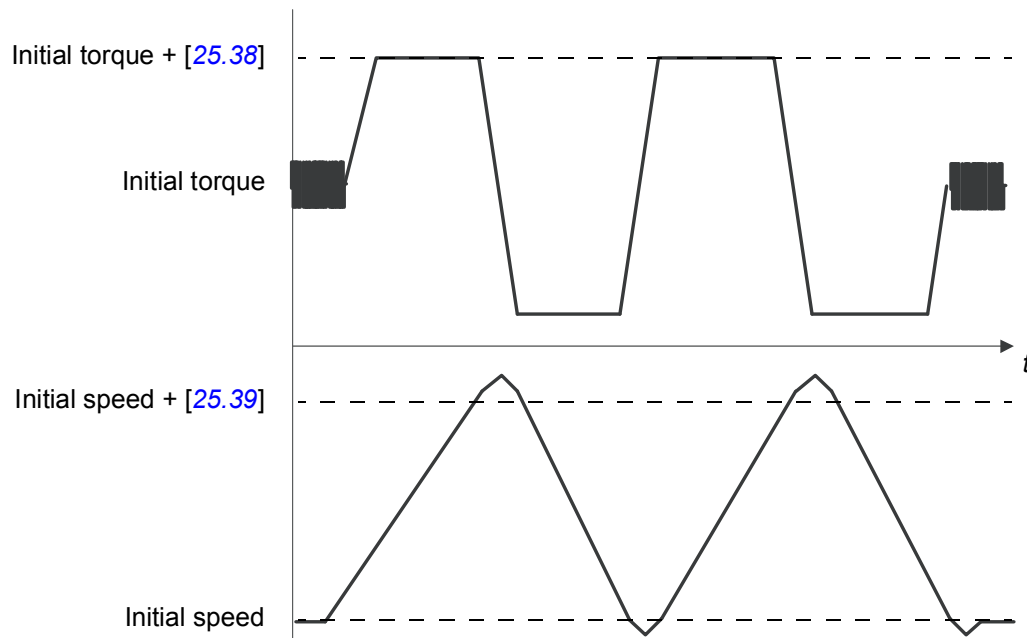

#### Notes:

- If the drive cannot produce the requested braking power during the routine, the results will be based on the acceleration stages only, and not as accurate as with full braking power.
- The motor will exceed the calculated maximum speed slightly at the end of each acceleration stage.

#### Before activating the autotune routine

The prerequisites for performing the autotune routine are:

- The motor identification run (ID run) has been successfully completed
- Speed and torque limits (parameter group [30 Limits](#)) have been set
- The speed feedback has been monitored for noise, vibrations and other disturbances caused by the mechanics of the system, and
  - speed feedback filtering (parameter group [90 Feedback selection](#))
  - speed error filtering ([24 Speed reference conditioning](#)) and
  - zero speed (parameters [21.06](#) and [21.07](#))
 have been set to eliminate these disturbances.
- The drive has been started and is running in speed control mode.

After these conditions have been fulfilled, autotuning can be activated by parameter [25.33 Speed controller autotune](#) (or the signal source selected by it).

## Autotune modes

Autotuning can be performed in three different ways depending on the setting of parameter [25.34 Speed controller autotune mode](#). The selections *Smooth*, *Normal* and *Tight* define how the drive torque reference should react to a speed reference step after tuning. The selection *Smooth* will produce a slow but robust response; *Tight* will produce a fast response but possibly too high gain values for some applications. The figure below shows speed responses at a speed reference step (typically 1...20%).

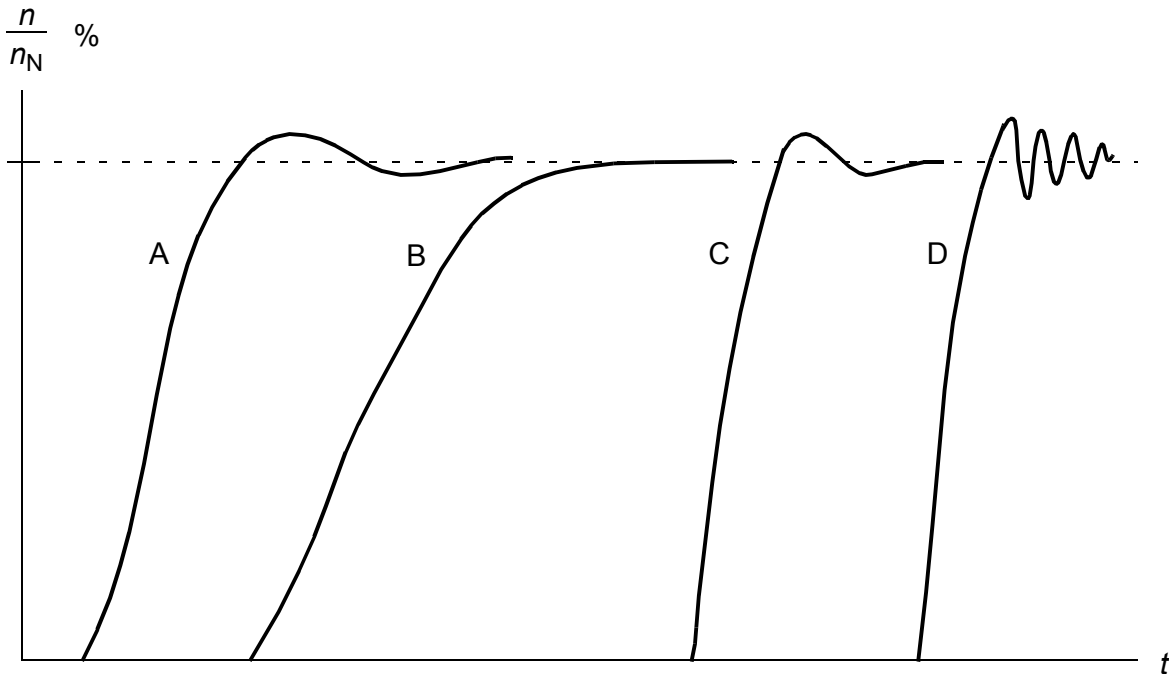

A: Undercompensated

B: Normally tuned (autotuning)

C: Normally tuned (manually). Better dynamic performance than with B

D: Overcompensated speed controller

## Autotune results

At the end of a successful autotune routine, its results are automatically transferred into parameters

- [25.02 Speed proportional gain](#) (proportional gain of the speed controller)
- [25.03 Speed integration time](#) (integration time of the speed controller)
- [25.37 Mechanical time constant](#) (mechanical time constant of the motor and machine).

Nevertheless, it is still possible to manually adjust the controller gain, integration time and derivation time.

The figure below is a simplified block diagram of the speed controller. The controller output is the reference for the torque controller.

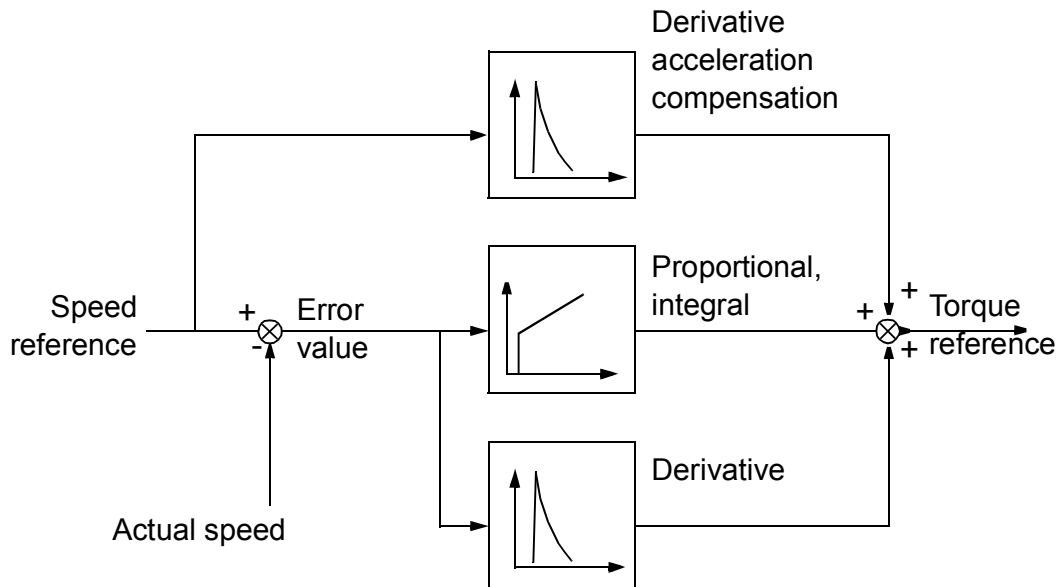

### Warning indications

A warning message, [AF90 Speed controller autotuning](#), will be generated if the autotune routine does not complete successfully. See chapter [Fault tracing](#) (page 487) for further information.

### Settings

Parameters [25.33...25.40](#) (page 238).

### ■ Oscillation damping

The oscillation damping function can be used to cancel out oscillations caused by mechanics or an oscillating DC voltage. The input – a signal reflecting the oscillation – is selected by parameter [26.53 Oscillation compensation input](#). The oscillation damping function outputs a sine wave ([26.58 Oscillation damping output](#)) which can be summed with the torque reference with a suitable gain ([26.57 Oscillation damping gain](#)) and phase shift ([26.56 Oscillation damping phase](#)).

The oscillation damping algorithm can be activated without connecting the output to the reference chain, which makes it possible to compare the input and output of the function and make further adjustments before applying the result.

## Tuning procedure for oscillation damping

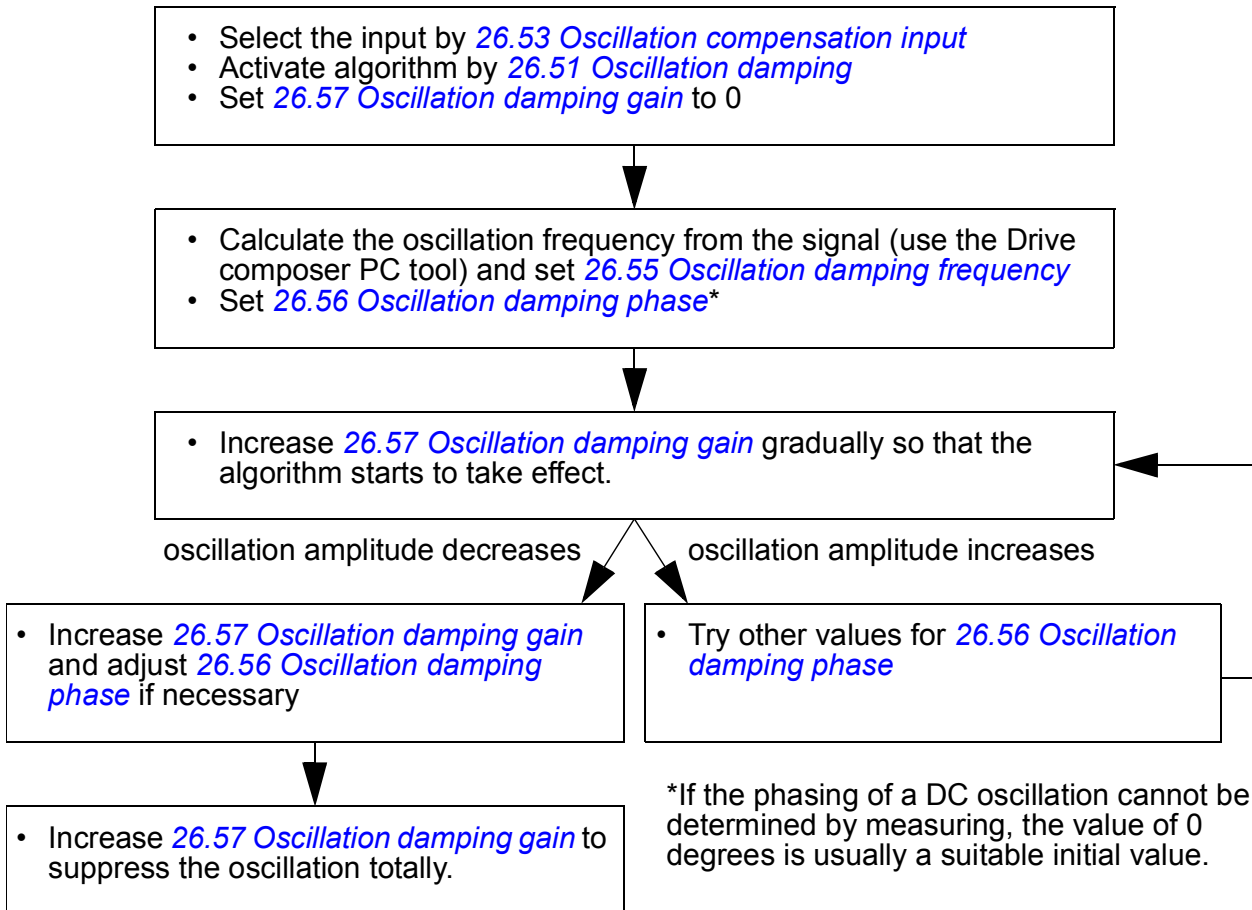

**Note:** Changing the speed error low-pass filter time constant or the integration time of the speed controller can affect the tuning of the oscillation damping algorithm. It is recommended to tune the speed controller before the oscillation damping algorithm. (The speed controller gain can be adjusted after the tuning of this algorithm.)

### Settings

Parameters [26.51](#)...[26.58](#) (page [244](#)).

### ■ Resonance frequency elimination

The control program contains a notch filter function for removing the resonance frequencies from the speed error signal.

### Settings

Parameters [24.13](#)...[24.17](#) (page [225](#)).

### ■ Rush control

In torque control, the motor could potentially rush if the load were suddenly lost. The control program has a rush control function that decreases the torque reference whenever the motor speed exceeds [30.11 Minimum speed](#) or [30.12 Maximum speed](#).



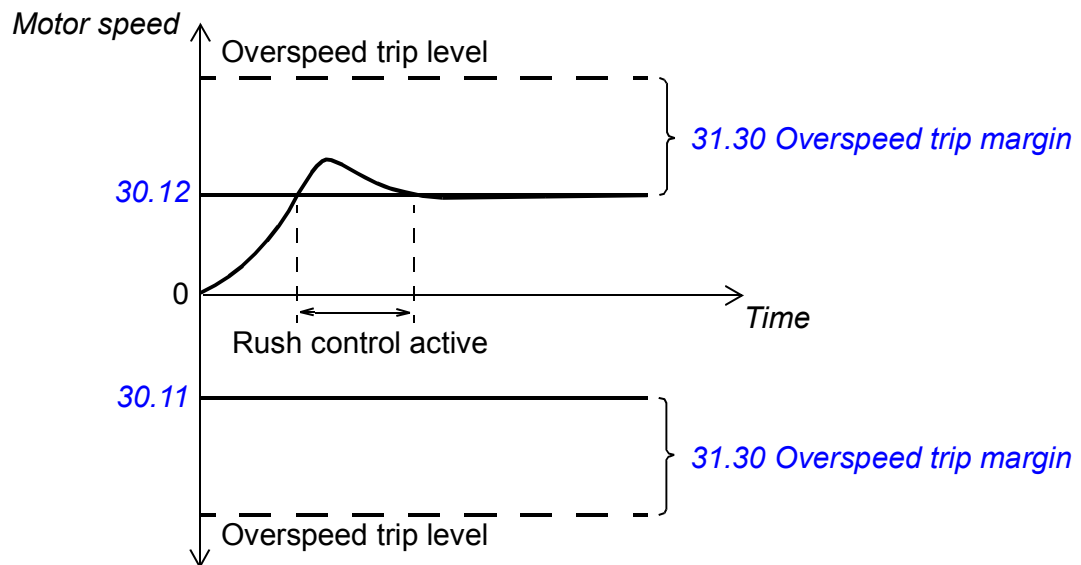

The function is based on a PI controller. The proportional gain and integration time can be defined by parameters. Setting these to zero disables rush control.

## Settings

Parameters [26.81 Rush control gain](#) and [26.82 Rush control integration time](#) (page [246](#)).

## Encoder support

The program supports two single-turn or multiturn encoders (or resolvers). The following optional interface modules are available:

- TTL encoder interface FEN-01: two TTL inputs, TTL output (for encoder emulation and echo) and two digital inputs
- Absolute encoder interface FEN-11: absolute encoder input, TTL input, TTL output (for encoder emulation and echo) and two digital inputs
- Resolver interface FEN-21: resolver input, TTL input, TTL output (for encoder emulation and echo) and two digital inputs
- HTL encoder interface FEN-31: HTL encoder input, TTL output (for encoder emulation and echo) and two digital inputs
- HTL/TTL encoder interface FSE-31 (for use with an FSO-xx safety functions module): Two HTL/TTL encoder inputs (one HTL input supported at the time of publication).

The interface module is to be installed onto one of the option slots on the drive control unit. The module (except the FSE-31) can also be installed onto an FEA-03 extension adapter.

## Encoder echo and emulation

Both encoder echo and emulation are supported by the above-mentioned FEN-xx interfaces.

Encoder echo is available with TTL, TTL+ and HTL encoders. The signal received from the encoder is relayed to the TTL output unchanged. This enables the connection of one encoder to several drives.

Encoder emulation also relays the encoder signal to the output, but the signal is either scaled, or position data converted to pulses. Emulation can be used when absolute encoder or resolver position needs to be converted to TTL pulses, or when the signal must be converted to a different pulse number than the original.

## Load and motor feedback

Three different sources can be used as speed and position feedback: encoder 1, encoder 2, or motor position estimate. Any of these can be used for load position calculation or motor control. The load position calculation makes it possible, for example, to determine the position of a conveyor belt or the height of the load on a crane. The feedback sources are selected by parameters [90.41 Motor feedback selection](#) and [90.51 Load feedback selection](#).

For detailed parameter connections of the motor and load feedback functions, see the block diagrams on pages [567](#) and [568](#). For more information on load position calculation, see section [Position counter](#) (page [51](#)).

Any mechanical gear ratios between the components (motor, motor encoder, load, load encoder) are specified using the gear parameters shown in the diagram below.

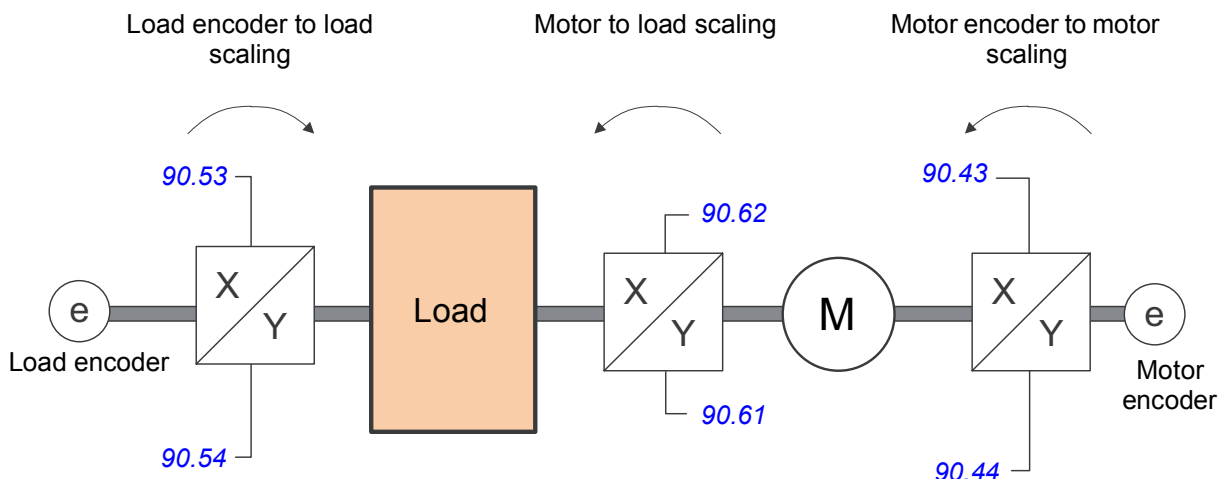

Any gear ratio between the load encoder and the load is defined by [90.53 Load gear numerator](#) and [90.54 Load gear denominator](#). Similarly, any gear ratio between the motor encoder and the motor is defined by [90.43 Motor gear numerator](#) and [90.44 Motor gear denominator](#). In case the internal estimated position is chosen as load feedback, the gear ratio between the motor and load can be defined by [90.61 Gear numerator](#) and [90.62 Gear denominator](#). By default, all of the ratios

mentioned above are 1:1. The ratios can only be changed with the drive stopped; new settings require validation by [91.10 Encoder parameter refresh](#).

### Position counter

The control program contains a position counter feature that can be used to indicate the position of the load. The output of the counter function, parameter [90.07 Load position scaled int](#), indicates the scaled number of revolutions read from the selected source (see section [Load and motor feedback](#) on page 50).

The relation between revolutions of the motor shaft and the translatory movement of the load (in any given unit of distance) is defined by parameters [90.63 Feed constant numerator](#) and [90.64 Feed constant denominator](#). This gear function can be changed without the need of a parameter refresh or position counter reinitialization – however, the counter output is only updated after new position input data is received.

For detailed parameter connections of the load feedback function, see the block diagram on page [568](#).

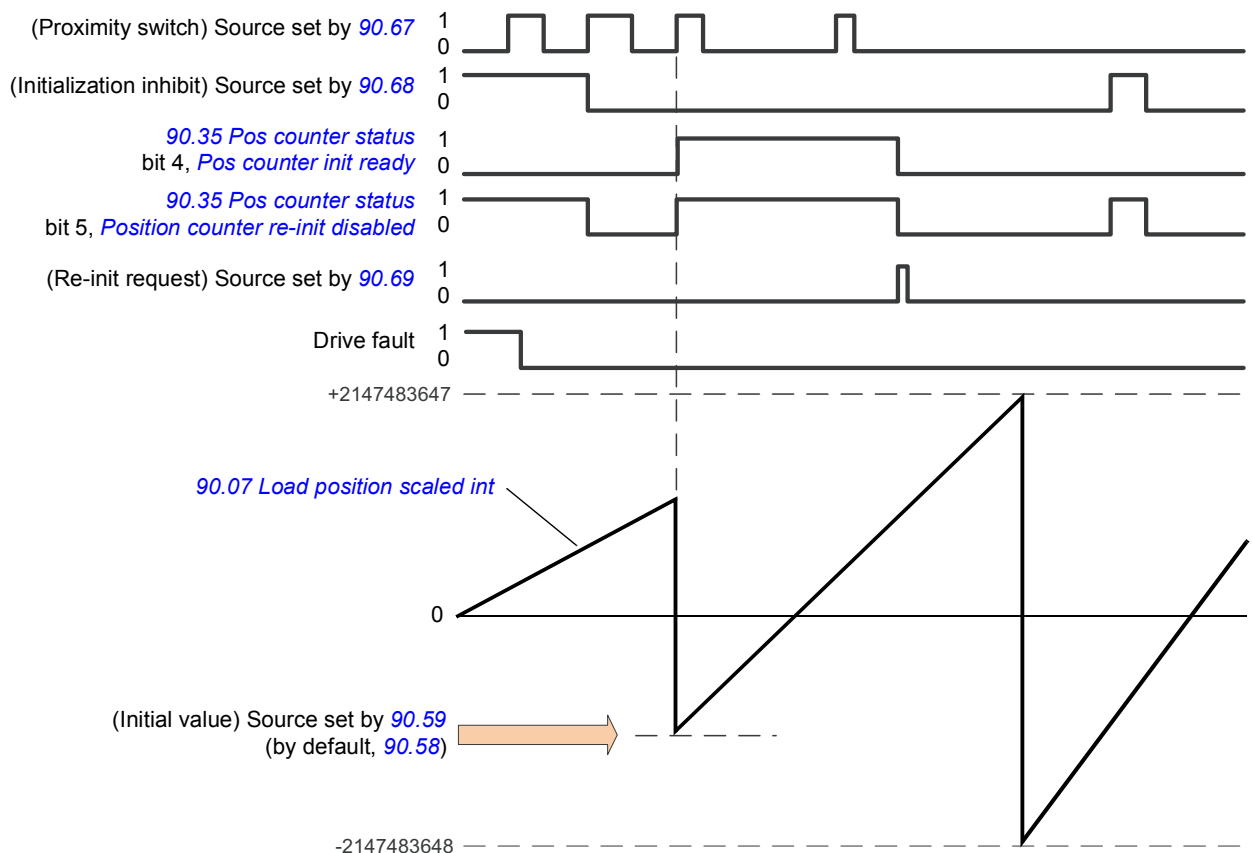

The position counter is initialized by setting a known physical position of the load into the control program. The initial position (for example, the home/zero position, or the distance from it) can be entered manually in a parameter ([90.58 Pos counter init value int](#)), or taken from another parameter. This position is set as the value of the position counter ([90.07 Load position scaled int](#)) when the source selected by [90.67](#)

*Pos counter init cmd source*, such as a proximity switch connected to a digital input, is activated. A successful initialization is indicated by bit 4 of *90.35 Pos counter status*.

Any subsequent initialization of the counter must first be enabled by *90.69 Reset pos counter init ready*. To define a time window for initializations, *90.68 Disable pos counter initialization* can be used to inhibit the signal from the proximity switch. An active fault in the drive will also prevent counter initialization.

### Encoder error handling

When an encoder is used for load feedback, the action taken in case of an encoder error is specified by *90.55 Load feedback fault*. If the parameter is set to *Warning*, the calculation will continue smoothly using estimated motor position. If the encoder recovers from the error, the calculation will smoothly switch back to encoder feedback. The load position signals (*90.04*, *90.05* and *90.07*) will continue to be updated all the time, but bit 6 of *90.35 Pos counter status* will be set to indicate potentially inaccurate position data. In addition, bit 4 of *90.35* will be cleared upon the next stop as a recommendation to reinitialize the position counter.

Parameter *90.60 Pos counter error and boot action* defines whether position calculation resumes from the previous value over an encoder error or control unit reboot. By default, bit 4 of *90.35 Pos counter status* is cleared after an error, indicating that reinitialization is needed. With *90.60* set to *Continue from previous value*, the position values are retained over an error or reboot; bit 6 of *90.35* is set however to indicate that an error occurred.

**Note:** With a multiturn absolute encoder, bit 6 of *90.35* is cleared at the next stop of the drive if the encoder has recovered from the error; bit 4 is not cleared. The status of the position counter is retained over a control unit reboot, after which position calculation resumes from the absolute position given by the encoder, taking into account the initial position specified by *90.58*.



**WARNING!** If the drive is in stopped state when an encoder error occurs, or if the drive is not powered, parameters *90.04*, *90.05*, *90.07* and *90.35* are not updated because no movement of the load can be detected. When using previous position values (*90.60 Pos counter error and boot action* is set to *Continue from previous value*), be aware that the position data is unreliable if the load is able to move.

---

### Reading/writing position counter values through fieldbus

The parameters of the position counter function, such as *90.07 Load position scaled int* and *90.58 Pos counter init value int*, can be accessed from an upper-level control system in the following formats:

- 16-bit integer (if 16 bits are sufficient for the application)
  - 32-bit integer (can be accessed as two consequent 16-bit words).
-

For example, to read parameter [90.07 Load position scaled int](#) through fieldbus, set the selection parameter of the desired dataset (in group 52) to *Other – 90.07*, and select the format. If you select a 32-bit format, the subsequent data word is also automatically reserved.

### Configuration of HTL encoder motor feedback

1. Specify the type of the encoder interface module (parameter [91.11 Module 1 type](#) = *FEN-31*) and the slot the module is installed into ([91.12 Module 1 location](#)).
2. Specify the type of the encoder ([92.01 Encoder 1 type](#) = *HTL*). The parameter listing will be re-read from the drive after the value is changed.
3. Specify the interface module that the encoder is connected to ([92.02 Encoder 1 source](#) = *Module 1*).
4. Set the number of pulses according to encoder nameplate ([92.10 Pulses/revolution](#)).
5. If the encoder rotates at a different speed to the motor (ie. is not mounted directly on the motor shaft), enter the gear ratio in [90.43 Motor gear numerator](#) and [90.44 Motor gear denominator](#).
6. Set parameter [91.10 Encoder parameter refresh](#) to *Refresh* to apply the new parameter settings. The parameter will automatically revert to *Done*.
7. Check that [91.02 Module 1 status](#) is showing the correct interface module type (*FEN-31*). Also check the status of the module; both LEDs should be glowing green.
8. Start the motor with a reference of eg. 400 rpm.
9. Compare the estimated speed ([01.02 Motor speed estimated](#)) with the measured speed ([01.04 Encoder 1 speed filtered](#)). If the values are the same, set the encoder as the feedback source ([90.41 Motor feedback selection](#) = *Encoder 1*).
10. Specify the action taken in case the feedback signal is lost ([90.45 Motor feedback fault](#)).

### Example 1: Using the same encoder for both load and motor feedback

The drive controls a motor used for lifting a load in a crane. An encoder attached to the motor shaft is used as feedback for motor control. The same encoder is also used for calculating the height of the load in the desired unit. A gear exists between the motor shaft and the cable drum. The encoder is configured as Encoder 1 as shown in [Configuration of HTL encoder motor feedback](#) above. In addition, the following settings are made:

- ([90.43 Motor gear numerator](#) = 1)
  - ([90.44 Motor gear denominator](#) = 1)
- (No gear is needed as the encoder is mounted directly on the motor shaft.)
- [90.51 Load feedback selection](#) = *Encoder 1*
-

## 54 Program features

- (90.53 Load gear numerator = 1)
- 90.54 Load gear denominator = 50

The cable drum turns one revolution per 50 revolutions of the motor shaft.

- (90.61 Gear numerator = 1)
- (90.62 Gear denominator = 1)

(These parameters need not be changed as position estimate is not being used for feedback.)

- 90.63 Feed constant numerator = 7
- 90.64 Feed constant denominator = 10

The load moves 70 centimeters, ie. 7/10 of a meter, per one revolution of the cable drum.

The load height in meters can be read from 90.07 Load position scaled int, while 90.03 Load speed displays the rotational speed of the cable drum.

### Example 2: Using two encoders

One encoder (encoder 1) is used for motor feedback. The encoder is connected to the motor shaft through a gear. Another encoder (encoder 2) measures the line speed elsewhere in the machine. Each encoder is configured as shown in Configuration of HTL encoder motor feedback above. In addition, the following settings are made:

- (90.41 Motor feedback selection = Encoder 1)
- (90.43 Motor gear numerator = 1)
- 90.44 Motor gear denominator = 3

The encoder turns three revolutions per one revolution of the motor shaft.

- 90.51 Load feedback selection = Encoder 2

The line speed measured by encoder 2 can be read from 90.03 Load speed. This value is given in rpm which can be converted into another unit by using 90.53 Load gear numerator and 90.54 Load gear denominator. Note that the feed constant gear cannot be used in this conversion because it does not affect 90.03 Load speed.

### Example 3: ACS 600 / ACS800 compatibility

With ACS 600 and ACS800 drives, both the rising and falling edges from encoder channels A and B are typically counted to achieve best possible accuracy. Thus the received pulse number per revolution equals four times the nominal pulse number of the encoder.

In this example, an HTL-type 2048-pulse encoder is fitted directly on the motor shaft. The desired initial position to correspond the proximity switch is 66770.

---

In the ACS880, the following settings are made:

- [92.01 Encoder 1 type](#) = HTL
- [92.02 Encoder 1 source](#) = Module 1
- [92.10 Pulses/revolution](#) = 2048
- [92.13 Position estimation enable](#) = Enable
- [90.51 Load feedback selection](#) = Encoder 1
- [90.63 Feed constant numerator](#) = 8192 (ie.  $4 \times$  value of [92.10](#), as the received number of pulses is 4 times nominal. See also parameter [92.12 Resolver polepairs](#))
- The desired “data out” parameter is set to Other – [90.58 Pos counter init value int](#) (32-bit format). Only the high word needs to be specified – the subsequent data word is reserved for the low word automatically.
- The desired sources (such as digital inputs or user bits of the control word) are selected in [90.67 Pos counter init cmd source](#) and [90.69 Reset pos counter init ready](#).

In the PLC, if the initial value is set in 32-bit format using low and high words (corresponding to ACS800 parameters POS COUNT INIT LO and POS COUNT INIT HI), enter the value 66770 into these words as follows:

Eg. PROFIBUS:

- FBA data out  $x$  = POS COUNT INIT HI = 1 (as bit 16 equals 66536)
- FBA data out  $(x + 1)$  = POS COUNT INIT LO = 1234.

ABB Automation using DDCS communication, eg.:

- Data set 12.1 = POS COUNT INIT HI
- Data set 12.2 = POS COUNT INIT LO

To test the configuration of the PLC, initialize the position counter with the encoder connected. The initial value sent from the PLC should immediately be reflected by [90.07 Load position scaled int](#) in the drive. The same value should then appear in the PLC after having been read from the drive.

## Settings

Parameter groups [90 Feedback selection](#) (page 378), [91 Encoder module settings](#) (page 387), [92 Encoder 1 configuration](#) (page 390) and [93 Encoder 2 configuration](#) (page 396).

## ■ Jogging

The jogging function enables the use of a momentary switch to briefly rotate the motor. The jogging function is typically used during servicing or commissioning to control the machinery locally.

Two jogging functions (1 and 2) are available, each with their own activation sources and references. The signal sources are selected by parameters [20.26 Jogging 1 start source](#) and [20.27 Jogging 2 start source](#). When jogging is activated, the drive starts and accelerates to the defined jogging speed ([22.42 Jogging 1 ref](#) or [22.43 Jogging 2](#)



*ref*) along the defined jogging acceleration ramp (23.20 *Acc time jogging*). After the activation signal switches off, the drive decelerates to a stop along the defined jogging deceleration ramp (23.21 *Dec time jogging*).

The figure and table below provide an example of how the drive operates during jogging. In the example, the ramp stop mode is used (see parameter 21.03 *Stop mode*).

Jog cmd = State of source set by 20.26 *Jogging 1 start source* or 20.27 *Jogging 2 start source*

Jog enable = State of source set by 20.25 *Jogging enable*

Start cmd = State of drive start command.

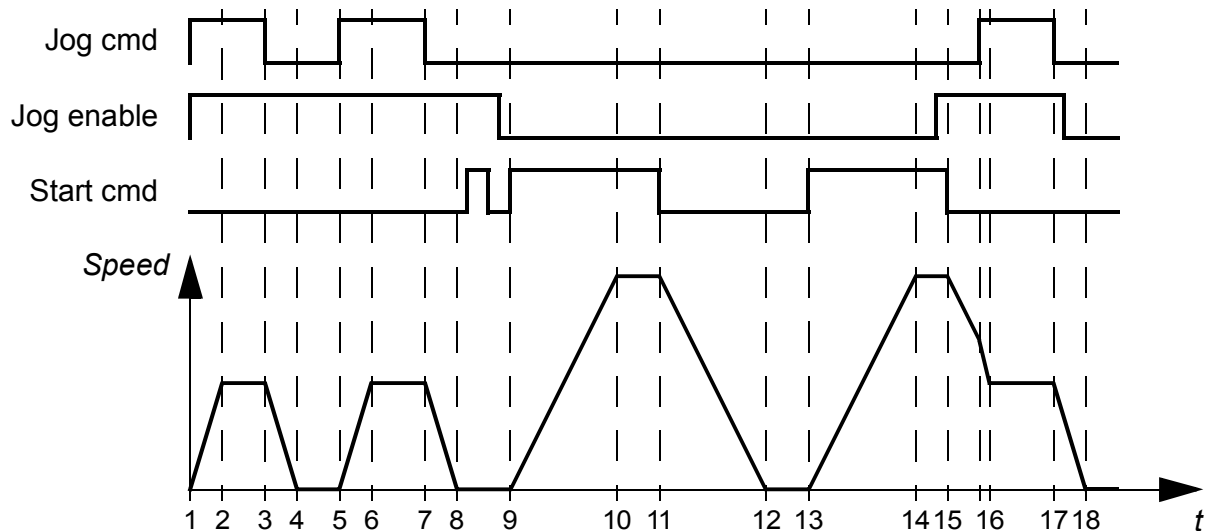

| Phase | Jog cmd | Jog enable | Start cmd | Description   |
|-------|---------|------------|-----------|---|
| 1-2   | 1       | 1          | 0         | Drive accelerates to the jogging speed along the acceleration ramp of the jogging function.   |
| 2-3   | 1       | 1          | 0         | Drive follows the jog reference.  |
| 3-4   | 0       | 1          | 0         | Drive decelerates to zero speed along the deceleration ramp of the jogging function.  |
| 4-5   | 0       | 1          | 0         | Drive is stopped.   |
| 5-6   | 1       | 1          | 0         | Drive accelerates to the jogging speed along the acceleration ramp of the jogging function.   |
| 6-7   | 1       | 1          | 0         | Drive follows the jog reference.  |
| 7-8   | 0       | 1          | 0         | Drive decelerates to zero speed along the deceleration ramp of the jogging function.  |
| 8-9   | 0       | 1->0       | 0         | Drive is stopped. As long as the jog enable signal is on, start commands are ignored. After jog enable switches off, a fresh start command is required. |
| 9-10  | x       | 0          | 1         | Drive accelerates to the speed reference along the selected acceleration ramp (parameters 23.11...23.19).   |



| Phase | Jog cmd | Jog enable | Start cmd | Description  |
|-------|---------|------------|-----------|--|
| 10-11 | x       | 0          | 1         | Drive follows the speed reference.   |
| 11-12 | x       | 0          | 0         | Drive decelerates to zero speed along the selected deceleration ramp (parameters <a href="#">23.11</a> ... <a href="#">23.19</a> ).  |
| 12-13 | x       | 0          | 0         | Drive is stopped.  |
| 13-14 | x       | 0          | 1         | Drive accelerates to the speed reference along the selected acceleration ramp (parameters <a href="#">23.11</a> ... <a href="#">23.19</a> ).   |
| 14-15 | x       | 0->1       | 1         | Drive follows the speed reference. As long as the start command is on, the jog enable signal is ignored. If the jog enable signal is on when the start command switches off, jogging is enabled immediately.   |
| 15-16 | 0->1    | 1          | 0         | Start command switches off. The drive starts to decelerate along the selected deceleration ramp (parameters <a href="#">23.11</a> ... <a href="#">23.19</a> ).<br>When the jog command switches on, the decelerating drive adopts the deceleration ramp of the jogging function. |
| 16-17 | 1       | 1          | 0         | Drive follows the jog reference.   |
| 17-18 | 0       | 1->0       | 0         | Drive decelerates to zero speed along the deceleration ramp of the jogging function.   |

See also the block diagram on page [566](#).

The jogging function operates on a 2 ms time level.

#### Notes:

- Jogging is not available when the drive is in local control.
- Jogging cannot be enabled when the drive start command is on, or the drive started when jogging is enabled. Starting the drive after the jog enable switches off requires a fresh start command.



**WARNING!** If jogging is enabled and activated while the start command is on, jogging will activate as soon as the start command switches off.

---

- If both jogging functions are activated, the one that was activated first has priority.
  - Jogging uses the speed control mode.
  - Ramp shape times (parameters [23.16](#)...[23.19](#)) do not apply to jogging acceleration/deceleration ramps.
  - The inching functions activated through fieldbus (see [06.01 Main control word](#), bits 8...9) use the references and ramp times defined for jogging, but do not require the jog enable signal.
-

## Settings

Parameters [20.25 Jogging enable](#) (page 202), [20.26 Jogging 1 start source](#) (page 202), [20.27 Jogging 2 start source](#) (page 203), [22.42 Jogging 1 ref](#) (page 214), [22.43 Jogging 2 ref](#) (page 214), [23.20 Acc time jogging](#) (page 221) and [23.21 Dec time jogging](#) (page 221).

### ■ Scalar motor control

It is possible to select scalar control as the motor control method instead of DTC (Direct Torque Control). In scalar control mode, the drive is controlled with a speed or frequency reference. However, the outstanding performance of DTC is not achieved in scalar control.

It is recommended to activate scalar motor control mode

- if the nominal current of the motor is less than 1/6 of the nominal output current of the drive
- if the drive is used without a motor connected (for example, for test purposes)
- if the drive runs a medium-voltage motor through a step-up transformer, or
- in multimotor drives, if
  - the load is not equally shared between the motors,
  - the motors are of different sizes, or
  - the motors are going to be changed after motor identification (ID run)

In scalar control, some standard features are not available.

See also section [Operating modes of the drive](#) (page 22).

### IR compensation for scalar motor control

IR compensation (also known as voltage boost) is available only when the motor control mode is scalar. When IR compensation is activated, the drive gives an extra voltage boost to the motor at low speeds. IR compensation is useful in applications that require a high break-away torque. In step-up applications, voltage cannot be fed through the transformer at 0 Hz, so an additional breakpoint is available for defining the compensation near zero frequency.

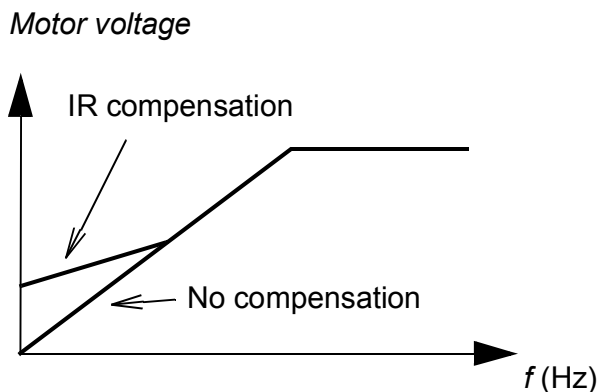

In Direct Torque Control (DTC), no IR compensation is possible or needed as it is applied automatically.

## Settings

- Parameters [19.20 Scalar control reference unit](#) (page 194), [97.12 IR comp step-up frequency](#) (page 419), [97.13 IR compensation](#) (page 420) and [99.04 Motor control mode](#) (page 423)
- Parameter group [28 Frequency reference chain](#) (page 246).

## ■ Autophasing

Autophasing is an automatic measurement routine to determine the angular position of the magnetic flux of a permanent magnet synchronous motor or the magnetic axis of a synchronous reluctance motor. The motor control requires the absolute position of the rotor flux in order to control motor torque accurately.

Sensors like absolute encoders and resolvers indicate the rotor position at all times after the offset between the zero angle of rotor and that of the sensor has been established. On the other hand, a standard pulse encoder determines the rotor position when it rotates but the initial position is not known. However, a pulse encoder can be used as an absolute encoder if it is equipped with Hall sensors, albeit with coarse initial position accuracy. Hall sensors generate so-called commutation pulses that change their state six times during one revolution, so it is only known within which 60° sector of a complete revolution the initial position is.

Many encoders give a zero pulse (also called Z-pulse) once during each rotation. The position of the zero pulse is fixed. If this position is known with respect to zero position used by motor control, the rotor position at the instant of the zero pulse is also known.

Using the zero pulse improves the robustness of the rotor position measurement. The rotor position must be determined during starting because the initial value given by the encoder is zero. The autophasing routine determines the position, but there is a risk of some position error. If the zero pulse position is known in advance, the position found by autophasing can be corrected as soon as the zero pulse is detected for the first time after starting.

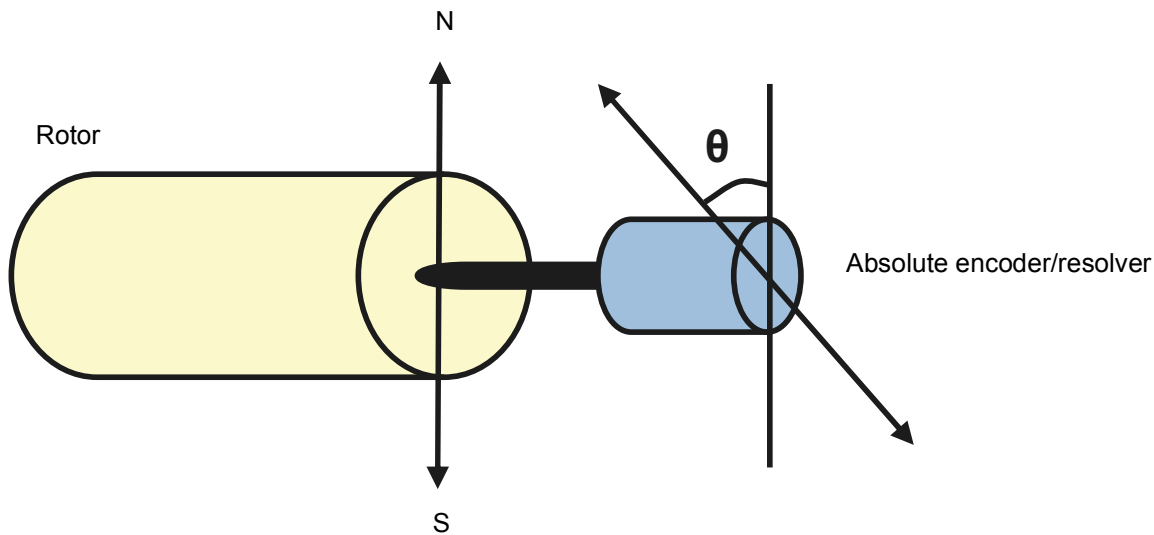

The autophasing routine is performed with permanent magnet synchronous motors and synchronous reluctance motors in the following cases:

1. One-time measurement of the rotor and encoder position difference when an absolute encoder, a resolver, or an encoder with commutation signals is used
2. At every power-up when an incremental encoder is used
3. With open-loop motor control, repetitive measurement of the rotor position at every start
4. When the position of the zero pulse must be measured before the first start after power-up.

**Note:** In closed-loop control, autophasing is performed automatically after the motor identification run (ID run). Autophasing is also performed automatically before starting when necessary.

In open-loop control, the zero angle of the rotor is determined before starting. In closed-loop control, the actual angle of the rotor is determined with autophasing when the sensor indicates zero angle. The offset of the angle must be determined because the actual zero angles of the sensor and the rotor do not usually match. The autophasing mode determines how this operation is done both in open-loop and closed-loop control.

The rotor position offset used in motor control can also be given by the user – see parameter [98.15 Position offset user](#). Note that the autophasing routine also writes its result into this parameter. The results are updated even if user settings are not enabled by [98.01 User motor model mode](#).

**Note:** In open-loop control, the motor always turns when it is started as the shaft is turned towards the remanence flux.

Bit 4 of [06.21 Drive status word 3](#) indicates if the rotor position has already been determined.

## Autophasing modes

Several autophasing modes are available (see parameter [21.13 Autophasing mode](#)).

The turning mode ([Turning](#)) is recommended especially with case 1 (see the list above) as it is the most robust and accurate method. In turning mode, the motor shaft is turned back and forward ( $\pm 360/\text{polepairs}$ )° in order to determine the rotor position. In case 3 (open-loop control), the shaft is turned only in one direction and the angle is smaller.

Another turning mode, [Turning with Z-pulse](#), can be used if there is difficulty using the normal turning mode, for example, because of significant friction. With this mode, the rotor is turned slowly until a zero pulse is detected from the encoder. When the zero pulse is detected for the first time, its position is stored into parameter [98.15 Position offset user](#), which can be edited for fine-tuning. Note that it is not mandatory to use this mode with a zero pulse encoder. In open-loop control, the two turning modes are identical.

The standstill modes ([Standstill 1](#), [Standstill 2](#)) can be used if the motor cannot be turned (for example, when the load is connected). As the characteristics of motors and loads differ, testing must be done to find out the most suitable standstill mode.

The drive is capable of determining the rotor position when started into a running motor in open-loop or closed-loop control. In this situation, the setting of [21.13 Autophasing mode](#) has no effect.

The autophasing routine can fail and therefore it is recommended to perform the routine several times and check the value of parameter [98.15 Position offset user](#).

An autophasing fault ([3385 Autophasing](#)) can occur with a running motor if the estimated angle of the motor differs too much from the measured angle. This could be caused by, for example, the following:

- The encoder is slipping on the motor shaft
- An incorrect value has been entered into [98.15 Position offset user](#)
- The motor is already turning before the autophasing routine is started
- [Turning](#) mode is selected in [21.13 Autophasing mode](#) but the motor shaft is locked
- [Turning with Z-pulse](#) mode is selected in [21.13 Autophasing mode](#) but no zero pulse is detected within a revolution of the motor
- The wrong motor type is selected in [99.03 Motor type](#)
- Motor ID run has failed.

## Settings and diagnostics

Parameters [06.21 Drive status word 3](#) (page 134), [21.13 Autophasing mode](#) (page 208), [98.15 Position offset user](#) (page 423) and [99.13 ID run requested](#) (page 426).

---

## Flux braking

The drive can provide greater deceleration by raising the level of magnetization in the motor. By increasing the motor flux, the energy generated by the motor during braking can be converted to motor thermal energy.

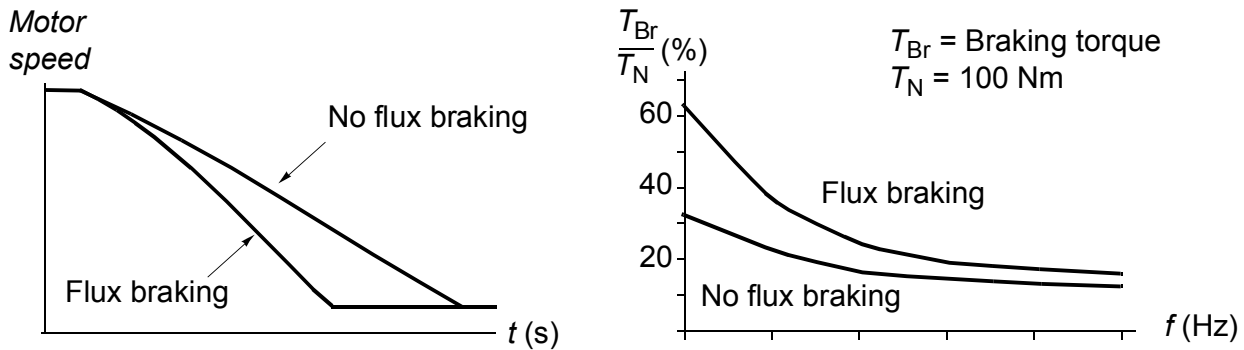

The drive monitors the motor status continuously, also during flux braking. Therefore, flux braking can be used both for stopping the motor and for changing the speed. The other benefits of flux braking are:

- The braking starts immediately after a stop command is given. The function does not need to wait for the flux reduction before it can start the braking.
- The cooling of the induction motor is efficient. The stator current of the motor increases during flux braking, not the rotor current. The stator cools much more efficiently than the rotor.
- Flux braking can be used with induction motors and permanent magnet synchronous motors.

Two braking power levels are available:

- Moderate braking provides faster deceleration compared to a situation where flux braking is disabled. The flux level of the motor is limited to prevent excessive heating of the motor.
- Full braking exploits almost all available current to convert the mechanical braking energy to motor thermal energy. Braking time is shorter compared to moderate braking. In cyclic use, motor heating may be significant.



**WARNING:** The motor needs to be rated to absorb the thermal energy generated by flux braking.

---

## Settings

Parameter [97.05 Flux braking](#) (page 417).

---

## ■ DC magnetization

DC magnetization can be applied to the motor to

- heat the motor to remove or prevent condensation, or
- to lock the rotor at, or near, zero speed.

### Pre-heating

A motor pre-heating function is available to prevent condensation in a stopped motor, or to remove condensation from the motor before start. Pre-heating involves feeding a DC current into the motor to heat up the windings.

Pre-heating is deactivated at start, or when one of the other DC magnetization functions is activated. With the drive stopped, pre-heating is disabled by the safe torque off function, a drive fault state, or the process PID sleep function. Pre-heating can only start after one minute has elapsed from stopping the drive.

A digital source to control pre-heating is selected by parameter [21.14 Pre-heating input source](#). The heating current is set by [21.16 Pre-heating current](#).

### Pre-magnetization

Pre-magnetization refers to DC magnetization of the motor before start. Depending on the selected start mode ([21.01 Start mode](#) or [21.19 Scalar start mode](#)), pre-magnetization can be applied to guarantee the highest possible breakaway torque, up to 200% of the nominal torque of the motor. By adjusting the pre-magnetization time ([21.02 Magnetization time](#)), it is possible to synchronize the motor start and, for example, the release of a mechanical brake.

### DC hold

The function makes it possible to lock the rotor at (near) zero speed in the middle of normal operation. DC hold is activated by parameter [21.08 DC current control](#). When both the reference and motor speed drop below a certain level (parameter [21.09 DC hold speed](#)), the drive will stop generating sinusoidal current and start to inject DC into the motor. The current is set by parameter [21.10 DC current reference](#). When the reference exceeds parameter [21.09 DC hold speed](#), normal drive operation continues.

---

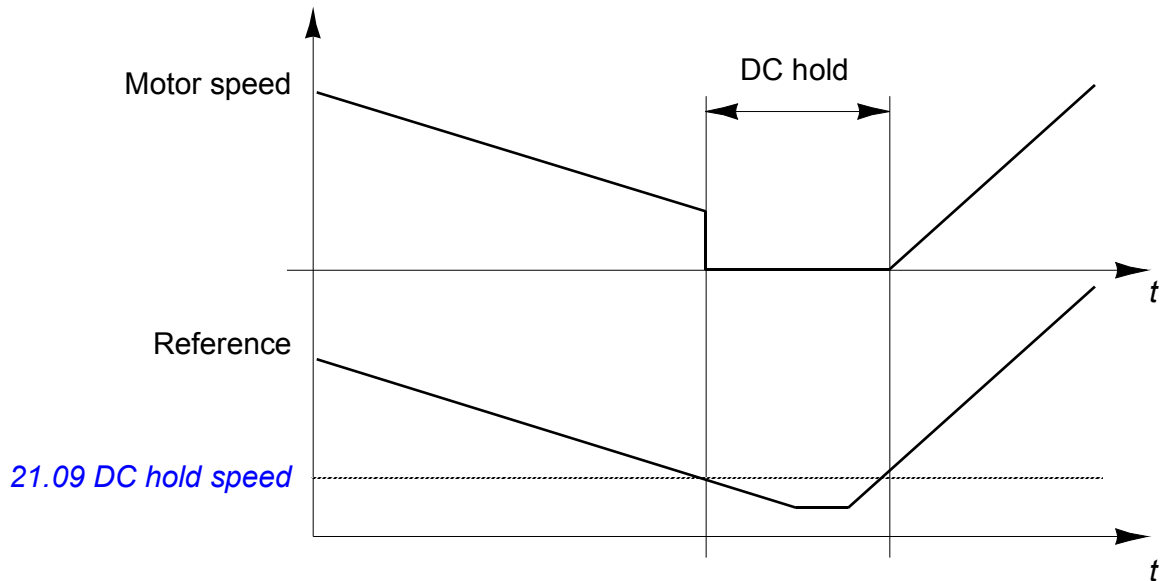
**Notes:**

- DC hold is only available in speed control in DTC motor control mode (see page [22](#)).
- The function applies the DC current to one phase only, depending on the position of the rotor. The return current will be shared between the other phases.

**Post-magnetization**

This feature keeps the motor magnetized for a certain period (parameter [21.11 Post magnetization time](#)) after stopping. This is to prevent the machinery from moving under load, for example before a mechanical brake can be applied. Post-magnetization is activated by parameter [21.08 DC current control](#). The magnetization current is set by parameter [21.10 DC current reference](#).

**Note:** Post-magnetization is only available in speed control in DTC motor control mode (see page [22](#)), and only when ramping is the selected stop mode (see parameter [21.03 Stop mode](#)).

**Continuous magnetization**

A digital signal, such as a user bit in the fieldbus control word, can be selected to activate continuous magnetization. This can be especially useful in processes requiring motors to be stopped (for example, to stand by until new material is processed), then quickly started without magnetizing them first.

**Note:** Continuous magnetization is only available in speed control in DTC motor control mode (see page [22](#)), and only when ramping is the selected stop mode (see parameter [21.03 Stop mode](#)).





**WARNING:** The motor must be designed to absorb or dissipate the thermal energy generated by continuous magnetization, for example by forced ventilation.

---

## Settings

Parameters [06.21 Drive status word 3](#) (page 134), [21.01 Start mode](#), [21.02 Magnetization time](#), [21.08...21.12](#), [21.14 Pre-heating input source](#) and [21.16 Pre-heating current](#) (page 203).

## ■ Hexagonal motor flux pattern

**Note:** This feature is only available in scalar motor control mode (see page 22).

Typically, the drive controls the motor flux so that the rotating flux vector follows a circular pattern. This is ideal for most applications. However, when operating above the field weakening point (FWP), it is not possible to reach 100% of the output voltage. This reduces the peak load capacity of the drive.

Using a hexagonal motor flux vector pattern, the maximum output voltage can be reached above the field weakening point. This increases the peak load capacity compared to the circular pattern, but the continuous load capacity in the range of FWP ...  $1.6 \times$  FWP is reduced because of increasing losses. With hexagonal motor flux active, the pattern changes from circular to hexagonal gradually as the frequency rises from 100% to 120% of the FWP.

## Settings

Parameters [97.18 Hexagonal field weakening](#) and [97.19 Hexagonal field weakening point](#) (page 420).

---

## Application control

### ■ Application macros

Application macros are predefined application parameter edits and I/O configurations. See chapter [Application macros](#) (page 95).

### ■ Process PID control

There is a built-in process PID controller in the drive. The controller can be used to control process variables such as pressure, flow or fluid level.

In process PID control, a process reference (setpoint) is connected to the drive instead of a speed reference. An actual value (process feedback) is also brought back to the drive. The process PID control adjusts the drive speed in order to keep the measured process quantity (actual value) at the desired level (setpoint).

Process PID control operates on a 2 ms time level.

The simplified block diagram below illustrates the process PID control. For a more detailed block diagram, see page 578.

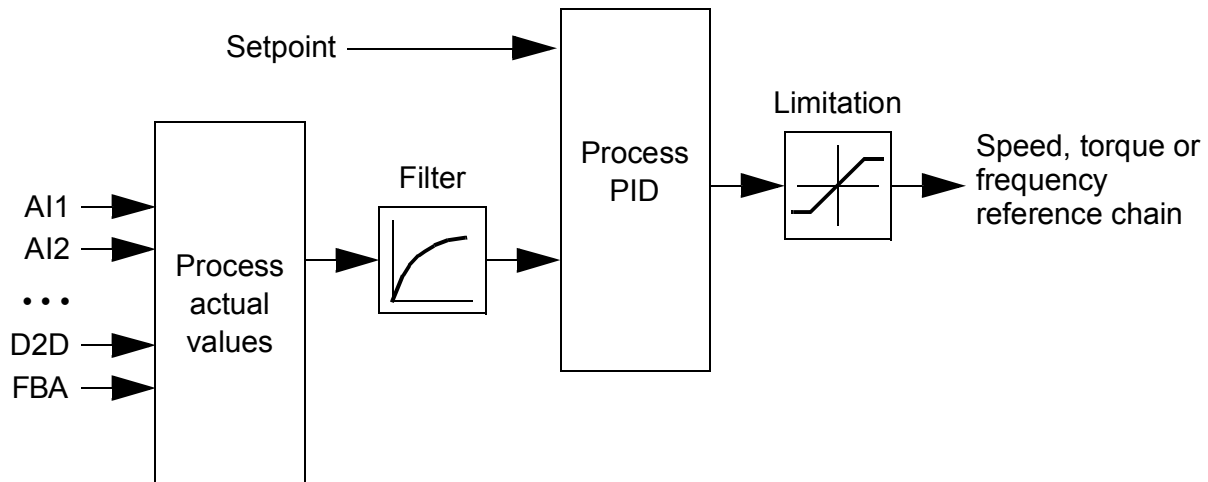

The control program contains two complete sets of process PID controller settings that can be alternated whenever necessary; see parameter [40.57 PID set1/set2 selection](#).

**Note:** Process PID control is only available in external control; see section [Local control vs. external control](#) (page 20).

### Quick configuration of the process PID controller

1. Activate the process PID controller (parameter [40.07 Set 1 PID operation mode](#)).
2. Select a feedback source (parameters [40.08...40.11](#)).
3. Select a setpoint source (parameters [40.16...40.25](#)).
4. Set the gain, integration time, derivation time, and the PID output levels ([40.32 Set 1 gain](#), [40.33 Set 1 integration time](#), [40.34 Set 1 derivation time](#), [40.36 Set 1 output min](#) and [40.37 Set 1 output max](#)).
5. The PID controller output is shown by parameter [40.01 Process PID output actual](#). Select it as the source of, for example, [22.11 Speed ref1 source](#).

### Sleep function for process PID control

The sleep function can be used in PID control applications that involve relatively long periods of low demand (for example, a tank is at level). During such periods, the sleep function saves energy by stopping the motor completely, instead of running the motor slowly below the efficient operating range of the system. When the feedback changes, the PID controller wakes the drive up.

**Note:** The sleep function is disabled when mechanical brake control (see page [70](#)) is active.

**Example:** The drive controls a pressure boost pump. The water consumption falls at night. As a consequence, the process PID controller decreases the motor speed. However, due to natural losses in the pipes and the low efficiency of the centrifugal pump at low speeds, the motor would never stop rotating. The sleep function detects the slow rotation and stops unnecessary pumping after the sleep delay has passed. The drive shifts into sleep mode, still monitoring the pressure. The pumping resumes when the pressure falls under the wake-up level (setpoint - wake-up deviation) and the wake-up delay has passed.

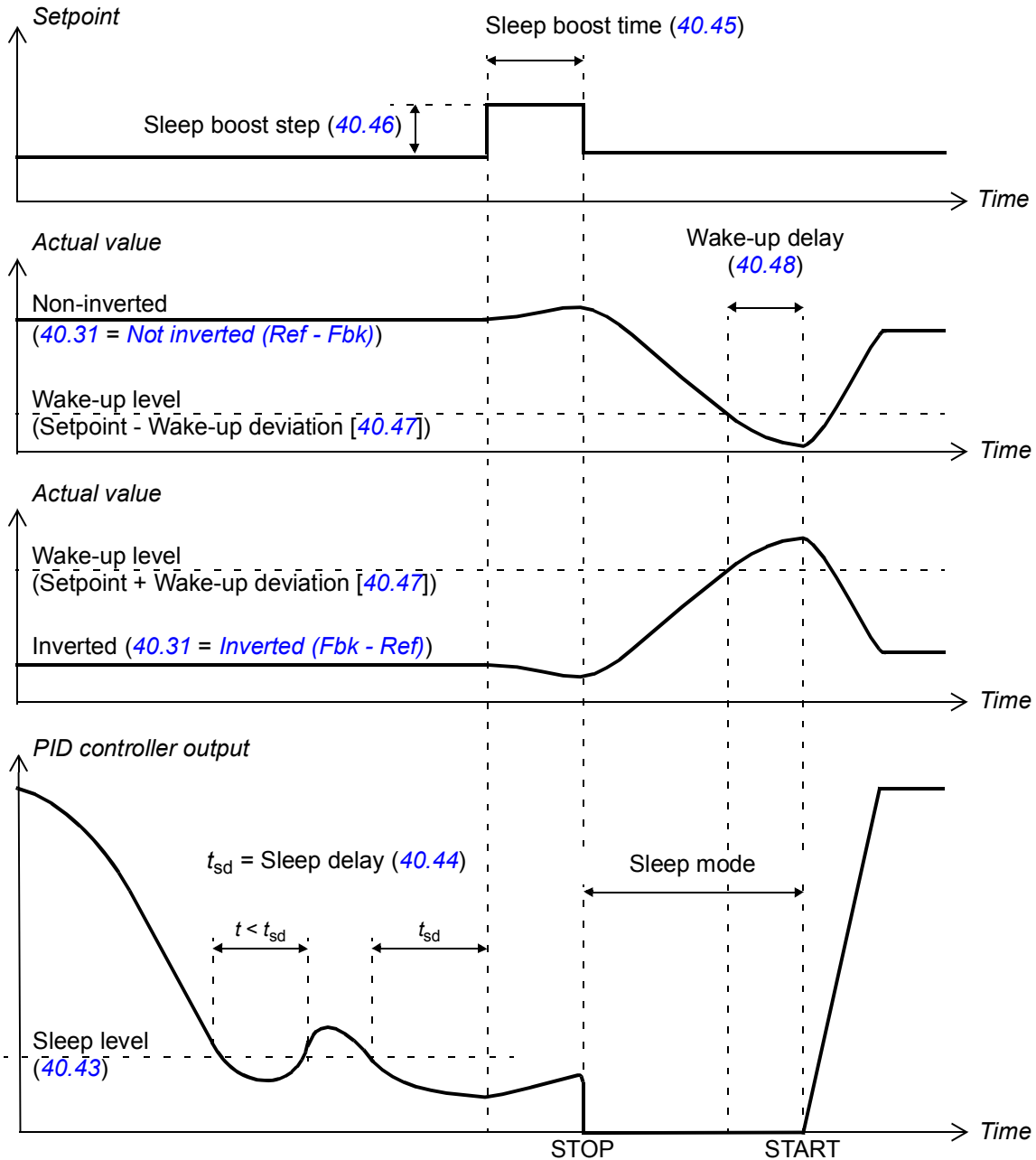

## Tracking

In tracking mode, the PID block output is set directly to the value of parameter [40.50](#) (or [41.50](#)) *Set 1 tracking ref selection*. The internal I term of the PID controller is set so that no transient is allowed to pass on to the output, so when the tracking mode is left, normal process control operation can be resumed without a significant bump.

## Settings

- Parameter [96.04 Macro select](#) (macro selection)
- Parameter groups [40 Process PID set 1](#) (page [301](#)) and [41 Process PID set 2](#) (page [313](#)).

## ■ Motor potentiometer

The motor potentiometer is, in effect, a counter whose value can be adjusted up and down using two digital signals selected by parameters [22.73 Motor potentiometer up source](#) and [22.74 Motor potentiometer down source](#). Note that these signals have no effect when the drive is stopped.

When enabled by [22.71 Motor potentiometer function](#), the motor potentiometer assumes the value set by [22.72 Motor potentiometer initial value](#). Depending on the mode selected in [22.71](#), the motor potentiometer value is either retained or reset over a stop or a power cycle.

The change rate is defined in [22.75 Motor potentiometer ramp time](#) as the time it would take for the value to change from the minimum ([22.76 Motor potentiometer min value](#)) to the maximum ([22.77 Motor potentiometer max value](#)) or vice versa. If the up and down signals are simultaneously on, the motor potentiometer value does not change.

The output of the function is shown by [22.80 Motor potentiometer ref act](#), which can directly be set as the source of any selector parameter such as [22.11 Speed ref1 source](#).

The following example shows the behavior of the motor potentiometer value.

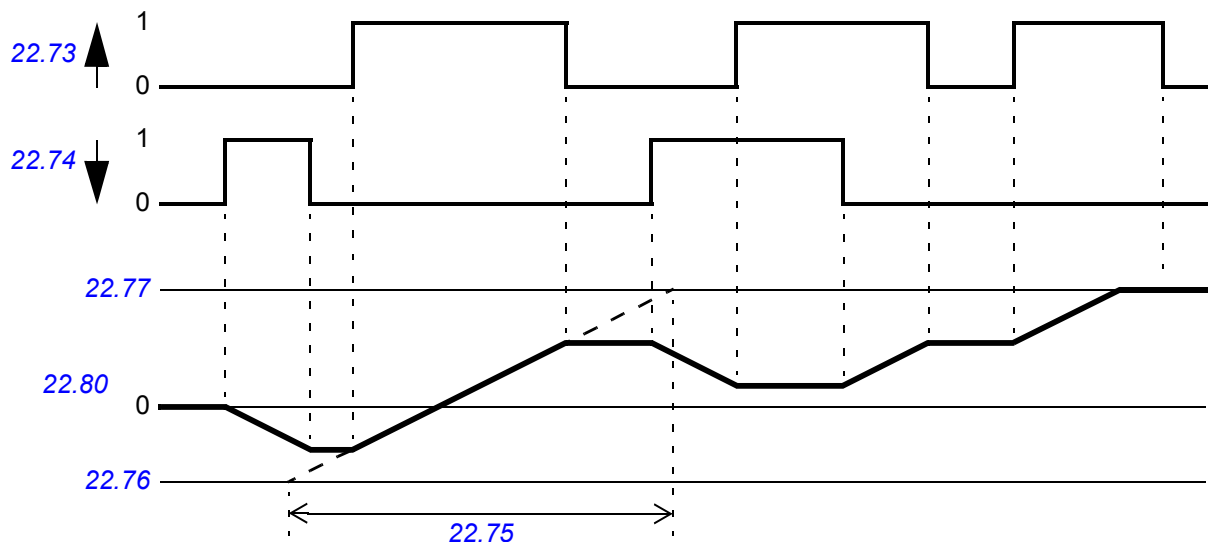

### Settings

Parameters [22.71](#)...[22.80](#) (page [215](#)).

## ■ Mechanical brake control

A mechanical brake can be used for holding the motor and driven machinery at zero speed when the drive is stopped, or not powered. The brake control logic observes the settings of parameter group [44 Mechanical brake control](#) as well as several external signals, and moves between the states presented in the diagram on page [71](#). The tables below the state diagram detail the states and transitions. The timing diagram on page [73](#) shows an example of a close-open-close sequence.

The mechanical brake control logic operates on a 10 ms time level.

### Inputs of the brake control logic

The start command of the drive (bit 5 of [06.16 Drive status word 1](#)) is the main control source of the brake control logic. An optional external open/close signal can be selected by [44.12 Brake close request](#). The two signals interact as follows:

- Start command = 1 **AND** signal selected by [44.12 Brake close request](#) = 0  
→ Request brake to **open**
- Start command = 0 **OR** signal selected by [44.12 Brake close request](#) = 1  
→ Request brake to **close**

Another external signal – for example, from a higher-level control system – can be connected via parameter [44.11 Keep brake closed](#) to prevent the brake from opening.

Other signals that affect the state of the control logic are

- brake status acknowledgement (optional, defined by [44.07 Brake acknowledge selection](#)),
- bit 2 of [06.11 Main status word](#) (indicates whether the drive is ready to follow the given reference or not),
- bit 6 of [06.16 Drive status word 1](#) (indicates whether the drive is modulating or not),
- optional FSO-xx safety functions module.

### Outputs of the brake control logic

The mechanical brake is to be controlled by bit 0 of parameter [44.01 Brake control status](#). This bit should be selected as the source of a relay output (or a digital input/output in output mode) which is then wired to the brake actuator through a relay. See the wiring example on page [74](#).

The brake control logic, in various states, will request the drive control logic to hold the motor, increase the torque, or ramp down the speed. These requests are visible in parameter [44.01 Brake control status](#).

### Settings

Parameter group [44 Mechanical brake control](#) (page [317](#)).

---

### Brake state diagram

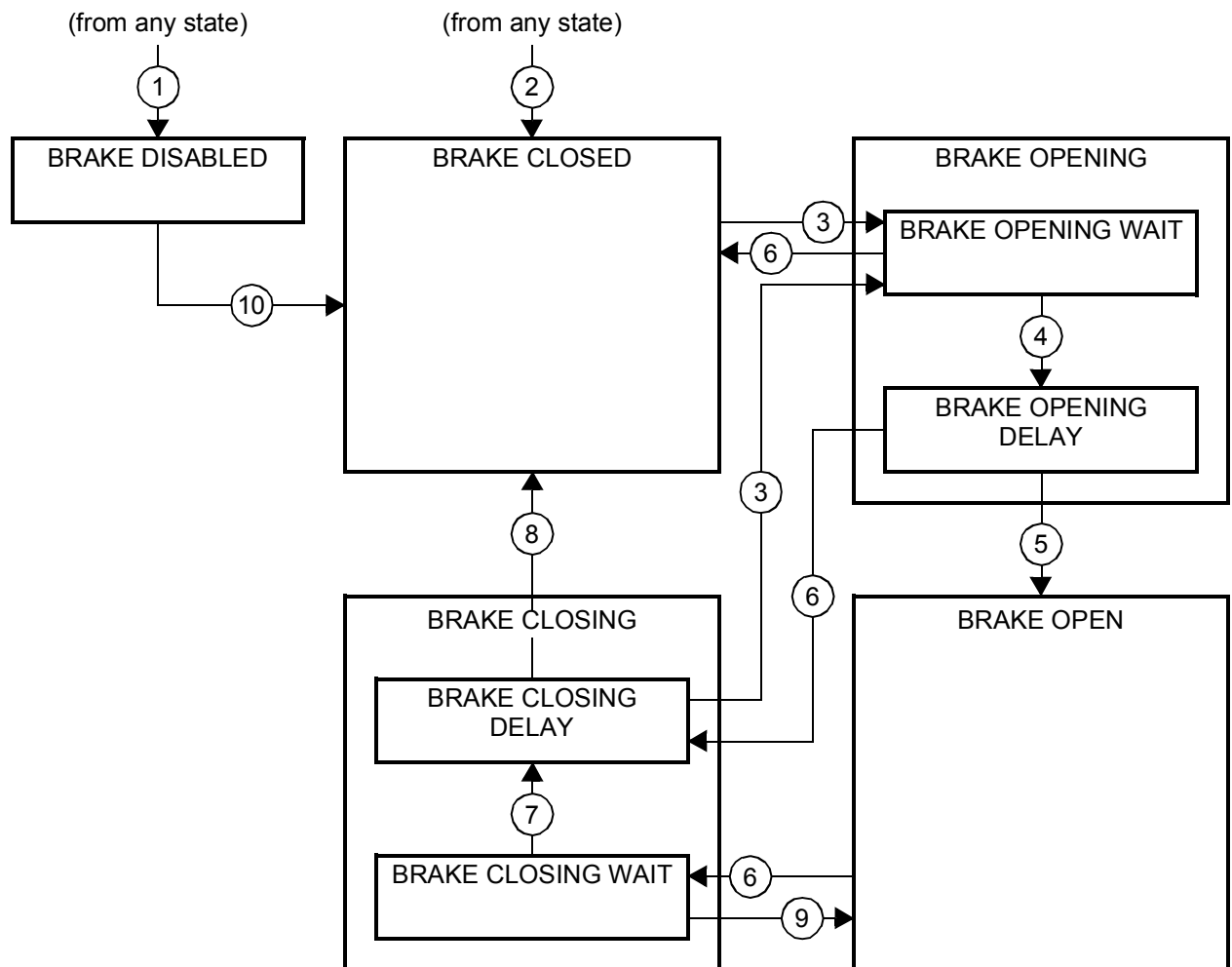

### State descriptions

| State name                 | Description   |
|----------------------------|---|
| <i>BRAKE DISABLED</i>      | Brake control is disabled (parameter <i>44.06 Brake control enable</i> = 0, and <i>44.01 Brake control status</i> b4 = 0). The brake is closed ( <i>44.01 Brake control status</i> b0 = 0).   |
| <i>BRAKE OPENING:</i>      |   |
| <i>BRAKE OPENING WAIT</i>  | Brake has been requested to open. The drive logic is requested to increase the torque up to opening torque to hold the load in place ( <i>44.01 Brake control status</i> b1 = 1 and b2 = 1). The state of <i>44.11 Keep brake closed</i> is checked; if it is not 0 within a reasonable time, the drive trips on a <i>71A5 Mechanical brake opening not allowed</i> fault*.   |
| <i>BRAKE OPENING DELAY</i> | Opening conditions have been met and open signal activated ( <i>44.01 Brake control status</i> b0 is set). The opening torque request is removed ( <i>44.01 Brake control status</i> b1 → 0). The load is held in place by the speed control of the drive until <i>44.08 Brake open delay</i> elapses.<br>At this point, if <i>44.07 Brake acknowledge selection</i> is set to <i>No acknowledge</i> , the logic proceeds to <i>BRAKE OPEN</i> state. If an acknowledgement signal source has been selected, its state is checked; if the state is not “brake open”, the drive trips on a <i>71A3 Mechanical brake opening failed</i> fault*. |
| <i>BRAKE OPEN</i>          | The brake is open ( <i>44.01 Brake control status</i> b0 = 1). Hold request is removed ( <i>44.01 Brake control status</i> b2 = 0), and the drive is allowed to follow the reference.   |

| State name   | Description   |
|--|---|
| <b>BRAKE CLOSING:</b>  |   |
| <b>BRAKE CLOSING WAIT</b>  | Brake has been requested to close. The drive logic is requested to ramp down the speed to a stop ( <a href="#">44.01 Brake control status</a> b3 = 1). The open signal is kept active ( <a href="#">44.01 Brake control status</a> b0 = 1). The brake logic will remain in this state until the motor speed has remained below <a href="#">44.14 Brake close level</a> for the time defined by <a href="#">44.15 Brake close level delay</a> .  |
| <b>BRAKE CLOSING DELAY</b>   | Closing conditions have been met. The open signal is deactivated ( <a href="#">44.01 Brake control status</a> b0 → 0) and the closing torque written into <a href="#">44.02 Brake torque memory</a> . The ramp-down request is maintained ( <a href="#">44.01 Brake control status</a> b3 = 1). The brake logic will remain in this state until <a href="#">44.13 Brake close delay</a> has elapsed.<br>At this point, if <a href="#">44.07 Brake acknowledge selection</a> is set to <i>No acknowledge</i> , the logic proceeds to <b>BRAKE CLOSED</b> state. If an acknowledgement signal source has been selected, its state is checked; if the state is not "brake closed", the drive generates an <a href="#">A7A1 Mechanical brake closing failed</a> warning. If <a href="#">44.17 Brake fault function</a> = <i>Fault</i> , the drive will trip on a <a href="#">71A2 Mechanical brake closing failed</a> fault after <a href="#">44.18 Brake fault delay</a> . |
| <b>BRAKE CLOSED</b>  | The brake is closed ( <a href="#">44.01 Brake control status</a> b0 = 0). The drive is not necessarily modulating.<br><b>Note concerning open-loop (encoderless) applications:</b> If the brake is kept closed by a brake close request (either from parameter <a href="#">44.12</a> or an FSO-xx safety functions module) against a modulating drive for longer than 5 seconds, the brake is forced to closed state and the drive trips on a fault, <a href="#">71A5 Mechanical brake opening not allowed</a> .  |
| *A warning can alternatively be selected by <a href="#">44.17 Brake fault function</a> ; if so, the drive will keep modulating and remain in this state. |   |

### State change conditions ( $\textcircled{n}$ )

- 1 Brake control disabled (parameter [44.06 Brake control enable](#) → 0).
- 2 [06.11 Main status word](#), bit 2 = 0 or brake is forced to close by optional FSO-xx safety functions module.
- 3 Brake has been requested to open and [44.16 Brake reopen delay](#) has expired.
- 4 Brake open conditions (such as [44.10 Brake open torque](#)) fulfilled and [44.11 Keep brake closed](#) = 0.
- 5 [44.08 Brake open delay](#) has elapsed and brake open acknowledgement (if chosen by [44.07 Brake acknowledge selection](#)) has been received.
- 6 Brake has been requested to close.
- 7 Motor speed has remained below closing speed [44.14 Brake close level](#) for the duration of [44.15 Brake close level delay](#).
- 8 [44.13 Brake close delay](#) has elapsed and brake close acknowledgement (if chosen by [44.07 Brake acknowledge selection](#)) has been received.
- 9 Brake has been requested to open.
- 10 Brake control enabled (parameter [44.06 Brake control enable](#) → 1).



## Timing diagram

The simplified timing diagram below illustrates the operation of the brake control function. Refer to the state diagram above.

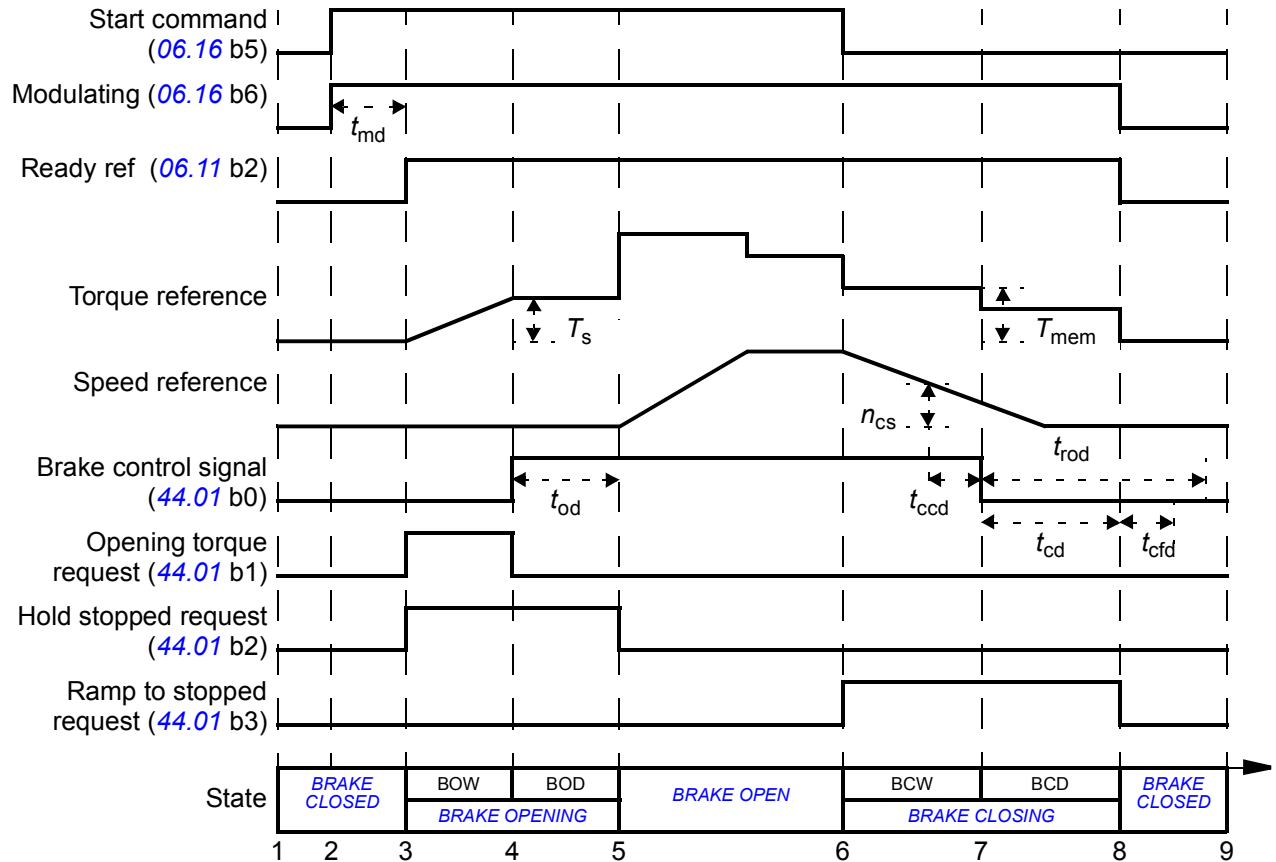

- $T_s$  Start torque at brake open (parameter [44.03 Brake open torque reference](#))
- $T_{mem}$  Stored torque value at brake close ([44.02 Brake torque memory](#))
- $t_{md}$  Motor magnetization delay
- $t_{od}$  Brake open delay (parameter [44.08 Brake open delay](#))
- $n_{cs}$  Brake close speed (parameter [44.14 Brake close level](#))
- $t_{ccd}$  Brake close command delay (parameter [44.15 Brake close level delay](#))
- $t_{cd}$  Brake close delay (parameter [44.13 Brake close delay](#))
- $t_{cfd}$  Brake close fault delay (parameter [44.18 Brake fault delay](#))
- $t_{rod}$  Brake reopen delay (parameter [44.16 Brake reopen delay](#))
- BOW [BRAKE OPENING WAIT](#)
- BOD [BRAKE OPENING DELAY](#)
- BCW [BRAKE CLOSING WAIT](#)
- BCD [BRAKE CLOSING DELAY](#)

## Wiring example

The figure below shows a brake control wiring example. The brake control hardware and wiring is to be sourced and installed by the customer.

---

**WARNING!** Make sure that the machinery into which the drive with brake control function is integrated fulfils the personnel safety regulations. Note that the frequency converter (a Complete Drive Module or a Basic Drive Module, as defined in IEC 61800-2), is not considered as a safety device mentioned in the European Machinery Directive and related harmonised standards. Thus, the personnel safety of the complete machinery must not be based on a specific frequency converter feature (such as the brake control function), but it has to be implemented as defined in the application specific regulations.

---

The brake is controlled by bit 0 of parameter [44.01 Brake control status](#). The source of brake acknowledge (status supervision) is selected by parameter [44.07 Brake acknowledge selection](#). In this example,

- parameter [10.24 RO1 source](#) is set to [Open brake command](#) (ie. bit 0 of [44.01 Brake control status](#)), and
- parameter [44.07 Brake acknowledge selection](#) is set to [DI5](#).

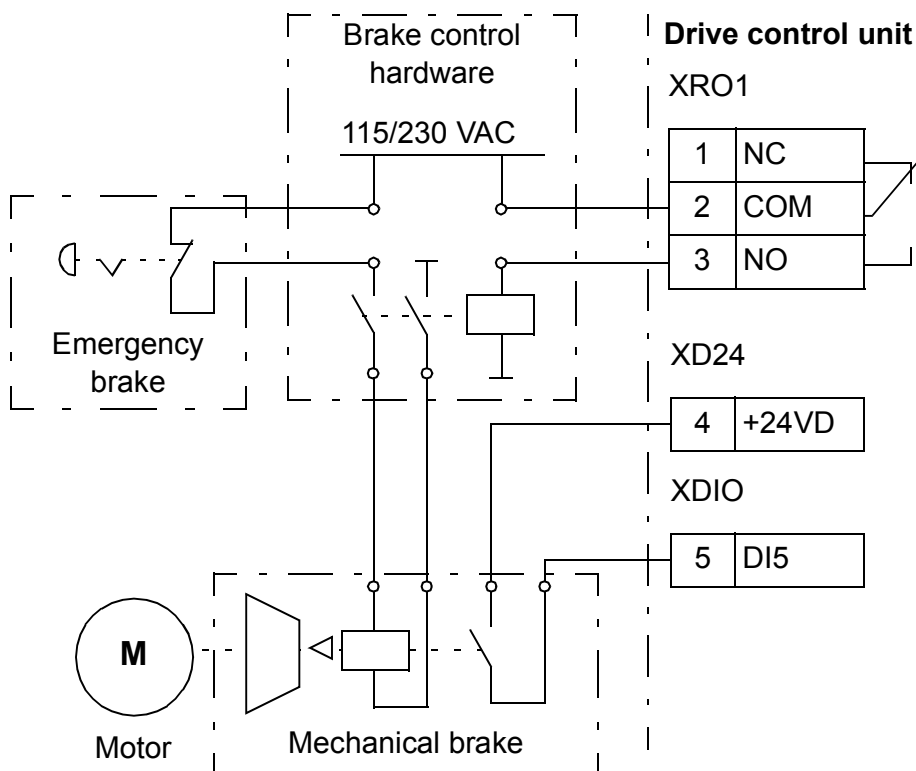

## DC voltage control

### ■ Overvoltage control

Overvoltage control of the intermediate DC link is typically needed when the motor is in generating mode. The motor can generate when it decelerates or when the load overhauls the motor shaft, causing the shaft to turn faster than the applied speed or frequency. To prevent the DC voltage from exceeding the overvoltage control limit, the overvoltage controller automatically decreases the generating torque when the limit is reached. The overvoltage controller also increases any programmed deceleration times if the limit is reached; to achieve shorter deceleration times, a brake chopper and resistor may be required.

### ■ Undervoltage control (power loss ride-through)

If the incoming supply voltage is cut off, the drive will continue to operate by utilizing the kinetic energy of the rotating motor. The drive will be fully operational as long as the motor rotates and generates energy to the drive. The drive can continue operation after the break if the main contactor (if present) remained closed.

**Note:** Units equipped with a main contactor must be equipped with a hold circuit (e.g. UPS) to keep the contactor control circuit closed during a short supply break.

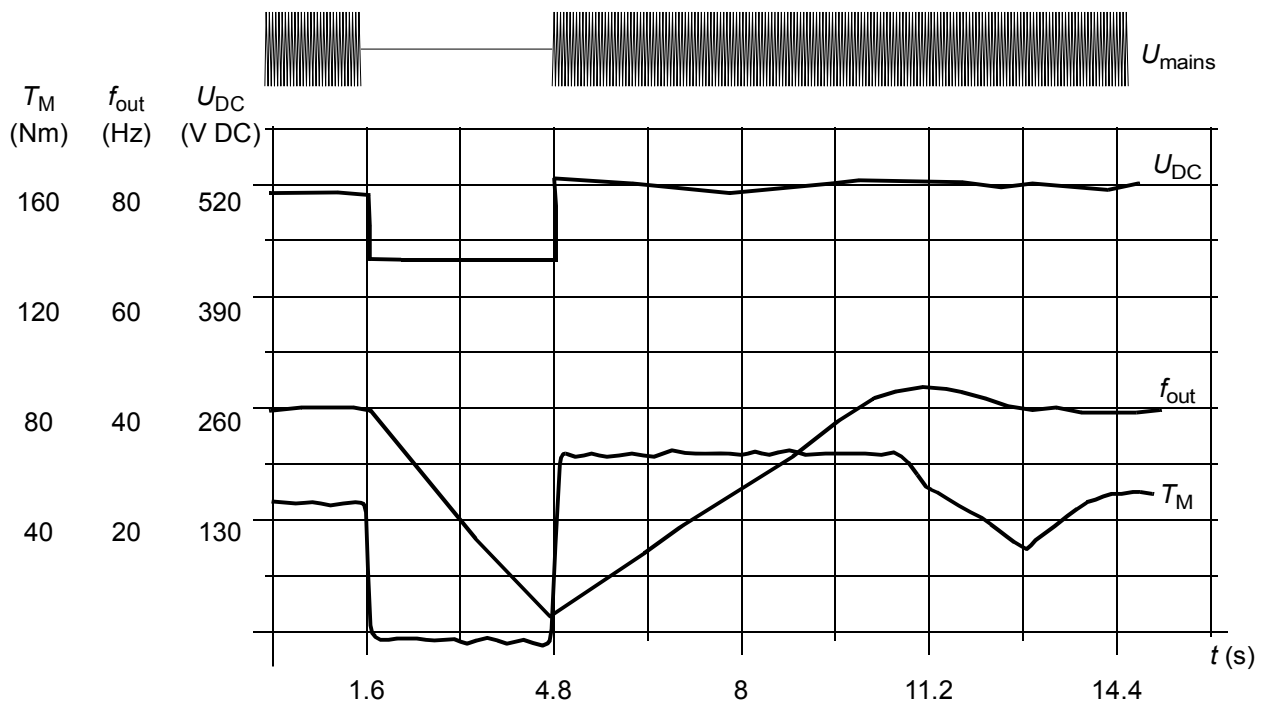

$U_{DC}$  = intermediate circuit voltage of the drive,  $f_{out}$  = output frequency of the drive,  $T_M$  = motor torque  
 Loss of supply voltage at nominal load ( $f_{out} = 40$  Hz). The intermediate circuit DC voltage drops to the minimum limit. The controller keeps the voltage steady as long as the mains is switched off. The drive runs the motor in generator mode. The motor speed falls but the drive is operational as long as the motor has enough kinetic energy.

## Automatic restart

It is possible to restart the drive automatically after a short (max. 5 seconds) power supply failure by using the Automatic restart function provided that the drive is allowed to run for 5 seconds without the cooling fans operating.

When enabled, the function takes the following actions upon a supply failure to enable a successful restart:

- The undervoltage fault is suppressed (but a warning is generated)
- Modulation and cooling is stopped to conserve any remaining energy
- DC circuit pre-charging is enabled.

If the DC voltage is restored before the expiration of the period defined by parameter [21.18 Auto restart time](#) and the start signal is still on, normal operation will continue. However, if the DC voltage remains too low at that point, the drive trips on a fault, [3280 Standby timeout](#).



**WARNING!** Before you activate the function, make sure that no dangerous situations can occur. The function restarts the drive automatically and continues operation after a supply break.

---

## ■ Voltage control and trip limits

The control and trip limits of the intermediate DC voltage regulator are relative to the supply voltage as well as drive/inverter type. The DC voltage is approximately 1.35 times the line-to-line supply voltage, and is displayed by parameter [01.11 DC voltage](#).

All levels are relative to the supply voltage range selected in parameter [95.01 Supply voltage](#). The following table shows the values of selected DC voltage levels in volts and in percent of  $U_{DCmax}$  (the DC voltage at the upper bound of the supply voltage range).

| Level [V DC (% of $U_{DCmax}$ )]                                | Supply voltage range [V AC] (see <a href="#">95.01 Supply voltage</a> ) |           |           |           |            |            |
|---|---|-----------|-----------|-----------|------------|------------|
|   | 208...240   | 380...415 | 440...480 | 500       | 525...600  | 660...690  |
| Overvoltage fault limit   | 489/440*  | 800       | 878       | 880       | 1113       | 1218       |
| Overvoltage control limit                                       | 405 (125)   | 700 (125) | 810 (125) | 810 (120) | 1013 (125) | 1167 (125) |
| Internal brake chopper at 100% pulse width                      | 403 (124)   | 697 (124) | 806 (124) | 806 (119) | 1008 (124) | 1159 (124) |
| Internal brake chopper at 0% pulse width                        | 375 (116)   | 648 (116) | 749 (116) | 780 (116) | 936 (116)  | 1077 (116) |
| Overvoltage warning limit                                       | 373 (115)   | 644 (115) | 745 (115) | 776 (115) | 932 (115)  | 1071 (115) |
| $U_{DCmax}$ = DC voltage at upper bound of supply voltage range | 324 (100)   | 560 (100) | 648 (100) | 675 (100) | 810 (100)  | 932 (100)  |
| DC voltage at lower bound of supply voltage range               | 281   | 513       | 594       | 675       | 709        | 891        |
| Undervoltage control and warning limit                          | 239 (85)  | 436 (85)  | 505 (85)  | 574 (85)  | 602 (85)   | 757 (85)   |
| Charging activation/standby limit                               | 225 (80)  | 410 (80)  | 475 (80)  | 540 (80)  | 567 (80)   | 713 (80)   |
| Undervoltage fault limit  | 168 (60)  | 308 (60)  | 356 (60)  | 405 (60)  | 425 (60)   | 535 (60)   |

\*489 V with frames R1...R3, 440 V with frames R4...R8.

## Settings

Parameters [01.11 DC voltage](#) (page 115), [30.30 Overvoltage control](#) (page 261), [30.31 Undervoltage control](#) (page 261), [95.01 Supply voltage](#) (page 400), and [95.02 Adaptive voltage limits](#) (page 401).

### ■ Brake chopper

A brake chopper can be used to handle the energy generated by a decelerating motor. When the DC voltage rises high enough, the chopper connects the DC circuit to an external brake resistor. The chopper operates on the pulse width modulation principle.

Some ACS880 drives have an internal brake chopper as standard, some have a brake chopper available as an internal or external option. See the appropriate hardware manual or sales catalog.

The internal brake choppers of ACS880 drives start conducting when the DC link voltage reaches  $1.156 \times U_{DCmax}$ . 100% pulse width is reached at approximately  $1.2 \times U_{DCmax}$ , depending on supply voltage range – see table under [Voltage control and trip limits](#) above. ( $U_{DCmax}$  is the DC voltage corresponding to the maximum of the AC supply voltage range.) For information on external brake choppers, refer to their documentation.

**Note:** For runtime braking, overvoltage control (parameter [30.30 Overvoltage control](#)) needs to be disabled for the chopper to operate.

## **Settings**

Parameters [01.11 DC voltage](#) (page [115](#)) and [30.30 Overvoltage control](#) (page [261](#));  
parameter group [43 Brake chopper](#) (page [315](#)).

---

## Safety and protections

### ■ Emergency stop

The emergency stop signal is connected to the input selected by parameter [21.05 Emergency stop source](#). An emergency stop can also be generated through fieldbus (parameter [06.01 Main control word](#), bits 0...2).

The mode of the emergency stop is selected by parameter [21.04 Emergency stop mode](#). The following modes are available:

- Off1: Stop along the standard deceleration ramp defined for the particular reference type in use
- Off2: Stop by coasting
- Off3: Stop by the emergency stop ramp defined by parameter [23.23 Emergency stop time](#).

With Off1 or Off3 emergency stop modes, the ramp-down of the motor speed can be supervised by parameters [31.32 Emergency ramp supervision](#) and [31.33 Emergency ramp supervision delay](#).

#### Notes:

- For SIL 3 / PL e-level emergency stop functions, the drive can be fitted with a TÜV-certified FSO-xx safety options module. The module can then be incorporated into certified safety systems.
- The installer of the equipment is responsible for installing the emergency stop devices and all additional devices needed for the emergency stop function to fulfill the required emergency stop categories. For more information, contact your local ABB representative.
- After an emergency stop signal is detected, the emergency stop function cannot be canceled even though the signal is canceled.
- If the minimum (or maximum) torque limit is set to 0%, the emergency stop function may not be able to stop the drive.
- Speed and torque reference additives (parameters [22.15](#), [22.17](#), [26.16](#), [26.25](#) and [26.41](#)) and reference ramp shapes ([23.16](#)...[23.19](#)) are ignored in case of emergency ramp stops.

#### Settings

Parameters [06.17 Drive status word 2](#) (page 131), [06.18 Start inhibit status word](#) (page 132), [21.04 Emergency stop mode](#) (page 205), [21.05 Emergency stop source](#) (page 205), [23.23 Emergency stop time](#) (page 221), [25.13 Min torq sp ctrl em stop](#) (page 235), [25.14 Max torq sp ctrl em stop](#) (page 235), [25.15 Proportional gain em stop](#) (page 235), [31.32 Emergency ramp supervision](#) (page 270) and [31.33 Emergency ramp supervision delay](#) (page 271).

---

## ■ Motor thermal protection

The control program features two separate motor temperature monitoring functions. The temperature data sources and warning/trip limits can be set up independently for each function.

The motor temperature can be monitored using

- the motor thermal protection model (estimated temperature derived internally inside the drive), or
- sensors installed in the windings. This will result in a more accurate motor model.

In addition to temperature monitoring, a protection function is available for 'Ex' motors installed in a potentially explosive atmosphere.

### Motor thermal protection model

The drive calculates the temperature of the motor on the basis of the following assumptions:

1. When power is applied to the drive for the first time, the motor is assumed to be at ambient temperature (defined by parameter [35.50 Motor ambient temperature](#)). After this, when power is applied to the drive, the motor is assumed to be at the estimated temperature.
2. Motor temperature is calculated using the user-adjustable motor thermal time and motor load curve. The load curve should be adjusted in case the ambient temperature exceeds 30 °C.

**Note:** The motor thermal model can be used when only one motor is connected to the inverter.

### Temperature monitoring using PTC sensors

One PTC sensor can be connected to digital input DI6.

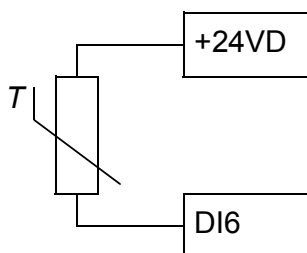

The resistance of the PTC sensor increases when its temperature rises. The increasing resistance of the sensor decreases the voltage at the input, and eventually its state switches from 1 to 0, indicating overtemperature.

1...3 PTC sensors can also be connected in series to an analog input and an analog output. The analog output feeds a constant excitation current of 1.6 mA through the sensor. The sensor resistance increases as the motor temperature rises, as does the



voltage over the sensor. The temperature measurement function calculates the resistance of the sensor and generates an indication if overtemperature is detected.

For wiring of the sensor, refer to the *Hardware Manual* of the drive.

The figure below shows typical PTC sensor resistance values as a function of temperature.

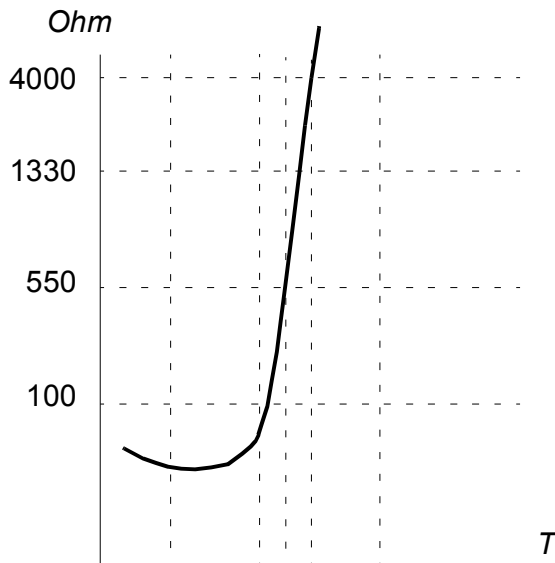

In addition to the above, optional FEN-xx encoder interfaces, and FPTC-xx modules have connections for PTC sensors. Refer to the module-specific documentation for more information.

### Temperature monitoring using Pt100 or Pt1000 sensors

1...3 Pt100 or Pt1000 sensors can be connected in series to an analog input and an analog output.

The analog output feeds a constant excitation current of 9.1 mA (Pt100) or 1 mA (Pt1000) through the sensor. The sensor resistance increases as the motor temperature rises, as does the voltage over the sensor. The temperature measurement function reads the voltage through the analog input and converts it into degrees Celsius.

The warning and fault limits can be adjusted by parameters.

For the wiring of the sensor, refer to the *Hardware Manual* of the drive.

### Temperature monitoring using KTY84 sensors

One KTY84 sensor can be connected to an analog input and an analog output on the control unit.

The analog output feeds a constant excitation current of 2.0 mA through the sensor. The sensor resistance increases as the motor temperature rises, as does the voltage over the sensor. The temperature measurement function reads the voltage through the analog input and converts it into degrees Celsius.

FEN-xx encoder interfaces (optional) also have a connection for one KTY84 sensor.

The figure and table below show typical KTY84 sensor resistance values as a function of the motor operating temperature.

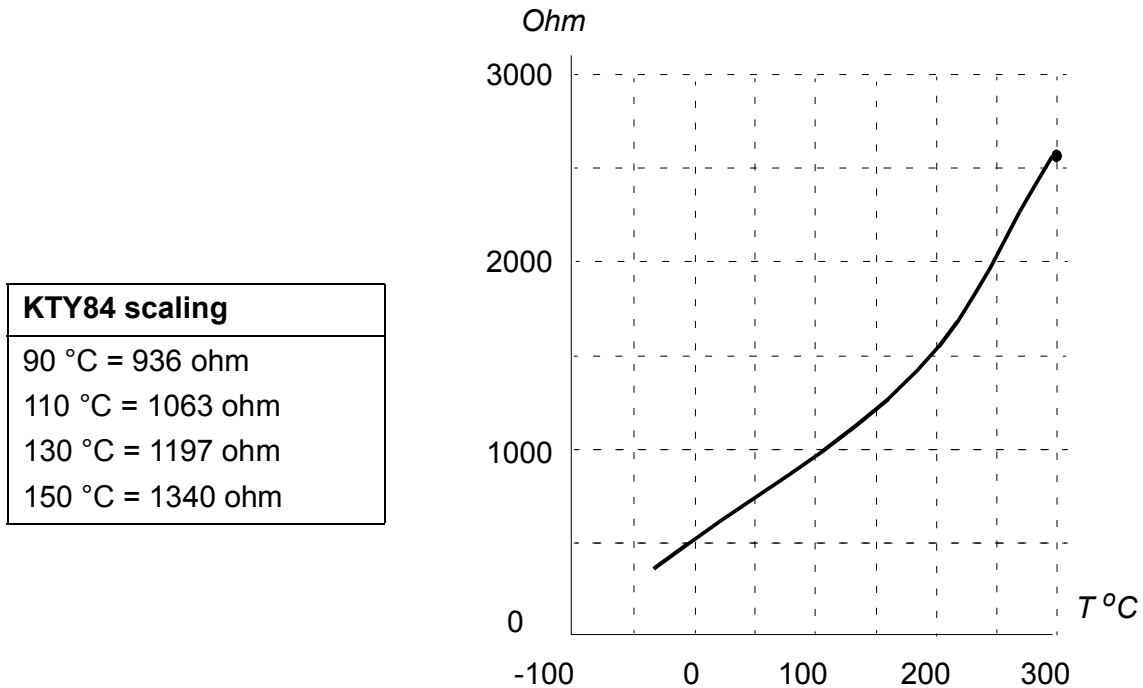

The warning and fault limits can be adjusted by parameters.

For the wiring of the sensor, refer to the *Hardware Manual* of the drive.

### Motor fan control logic (parameters [35.100](#)...[35.106](#))

If the motor has an external cooling fan, it is possible to use a drive signal (for example, running/stopped) to control the starter of the fan via a relay or digital output. A digital input can be selected for fan feedback. A loss of the feedback signal will optionally cause a warning or a fault.

Start and stop delays can be defined for the fan. In addition, a feedback delay can be set to define the time within which feedback must be received after the fan starts.

### Ex motor support (parameter [95.15](#), bit 0)

The control program has a temperature protection function for Ex motors located in a potentially explosive atmosphere. The protection is enabled by setting bit 0 of parameter [95.15 Special HW settings](#).

### Settings

Parameter groups [35 Motor thermal protection](#) (page 284) and [91 Encoder module settings](#) (page 387); parameter [95.15 Special HW settings](#) (page 403).

## ■ Thermal protection of motor cable

The control program contains a thermal protection function for the motor cable. This function should be used, for example, when the nominal current of the drive exceeds the current-carrying capacity of the motor cable.

The program calculates the temperature of the cable on the basis of the following data:

- Measured output current (parameter [01.07 Motor current](#))
- Nominal continuous current rating of the cable, specified by [35.61 Cable nominal current](#), and
- Thermal time constant of the cable, specified by [35.62 Cable thermal rise time](#).

When the calculated temperature of the cable reaches 102% of the rated maximum, a warning ([A480 Motor cable overload](#)) is given. The drive trips on a fault ([4000 Motor cable overload](#)) when 106% is reached.

### Settings

Parameters [35.60...35.62](#) (page [292](#)).

## ■ User load curve

The user load curve provides a function that monitors an input signal (eg. motor torque or motor current) as a function of drive output speed or frequency. The function includes both high limit (overload) and low limit (underload) monitoring. Overload monitoring can, for example, be used to detect a pump becoming clogged or a saw blade hitting a knot. Underload monitoring can detect the load being lost, for example because of the snapping of a transmission belt.

The monitoring is effective within a motor speed and/or frequency range. The frequency range is used with a frequency reference in scalar motor control mode; otherwise, the speed range is used. The range is defined by five speed (parameters [37.11...37.15](#)) or frequency ([37.16...37.20](#)) values. The values are positive, but the monitoring is symmetrically active in the negative direction as the sign of the monitored signal is ignored. Outside the speed/frequency range, the monitoring is disabled.

An underload ([37.21...37.25](#)) and overload ([37.31...37.35](#)) limit is set for each of the five speed or frequency points. Between these points, the limits are interpolated linearly to form overload and underload curves.

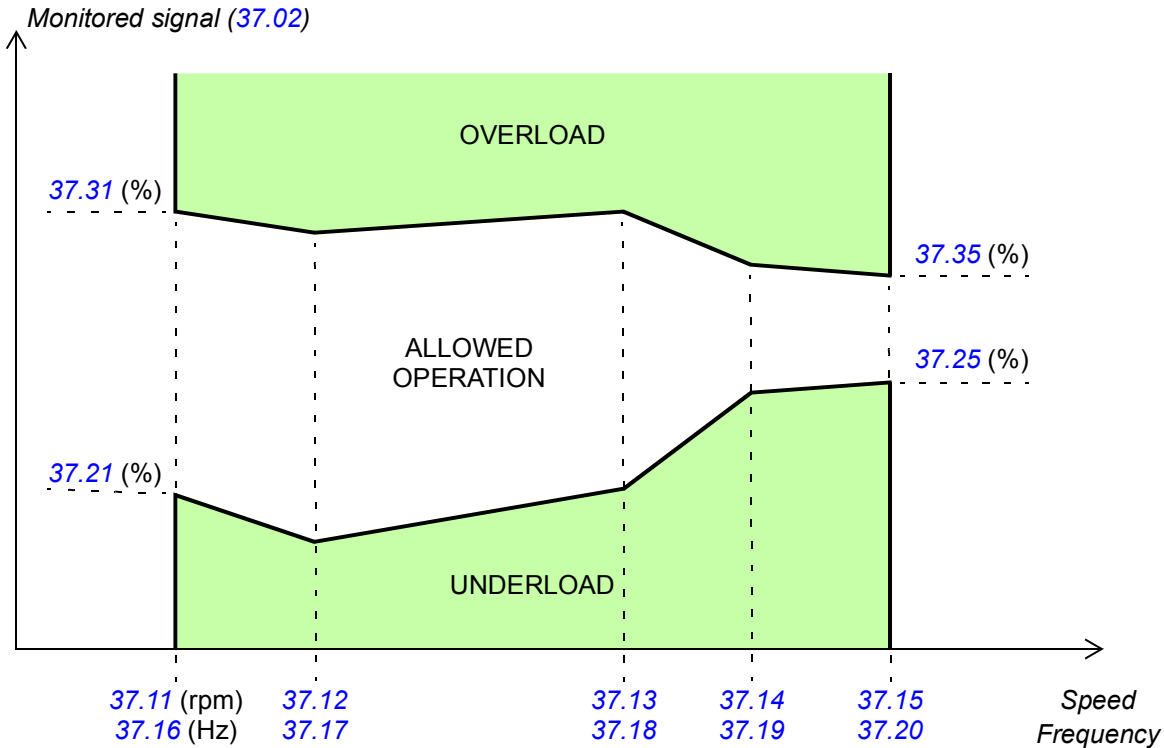

The action (none, warning or fault) taken when the signal exits the allowed operation area can be selected separately for overload and underload conditions (parameters [37.03](#) and [37.04](#) respectively). Each condition also has an optional timer to delay the selected action ([37.41](#) and [37.42](#)).

## Settings

Parameter group [37 User load curve](#) (page [298](#)).

### Automatic fault resets

The drive can automatically reset itself after overcurrent, overvoltage, undervoltage and external faults. The user can also specify a fault (excluding Safe torque off related faults) to be reset automatically.

By default, automatic resets are off and must be specifically activated by the user.



**WARNING!** Before you activate the function, make sure that no dangerous situations can occur. The function resets the drive automatically and continues operation after a fault.

---

## Settings

Parameters [31.12](#)...[31.16](#) (page [265](#)).

---

## ■ Other programmable protection functions

### External events (parameters 31.01...31.10)

Five different event signals from the process can be connected to selectable inputs to generate trips and warnings for the driven equipment. When the signal is lost, an external event (fault, warning, or a mere log entry) is generated. The contents of the messages can be edited on the control panel by selecting **Menu - Settings - Edit texts**.

### Motor phase loss detection (parameter 31.19)

The parameter selects how the drive reacts whenever a motor phase loss is detected.

### Earth (Ground) fault detection (parameter 31.20)

The earth fault detection function is based on sum current measurement. Note that

- an earth fault in the supply cable does not activate the protection
- in a grounded supply, the protection activates within 2 milliseconds
- in an ungrounded supply, the supply capacitance must be 1 microfarad or more
- the capacitive currents caused by shielded motor cables up to 300 meters will not activate the protection
- the protection is deactivated when the drive is stopped.

### Supply phase loss detection (parameter 31.21)

The parameter selects how the drive reacts whenever a supply phase loss is detected.

### Safe torque off detection (parameter 31.22)

The drive monitors the status of the Safe torque off input, and this parameter selects which indications are given when the signals are lost. (The parameter does not affect the operation of the Safe torque off function itself). For more information on the Safe torque off function, see the *Hardware manual*.

### Swapped supply and motor cabling (parameter 31.23)

The drive can detect if the supply and motor cables have accidentally been swapped (for example, if the supply is connected to the motor connection of the drive). The parameter selects if a fault is generated or not. Note that the protection should be disabled in drive/inverter hardware supplied from a common DC bus.

### Stall protection (parameters 31.24...31.28)

The drive protects the motor in a stall situation. It is possible to adjust the supervision limits (current, frequency and time) and choose how the drive reacts to a motor stall condition.

---

### **Overspeed protection (parameter [31.30](#))**

The user can set overspeed limits by specifying a margin that is added to the currently-used maximum and minimum speed limits.

### **Ramp stop supervision (parameters [31.32](#), [31.33](#), [31.37](#) and [31.38](#))**

The control program has a supervision function for both the normal and emergency stop ramps. The user can either define a maximum time for stopping, or a maximum deviation from the expected deceleration rate. If the drive fails to stop in the expected manner, a fault is generated and the drive coasts to a stop.

### **Main cooling fan supervision (parameter [31.35](#))**

The parameter selects how the drive reacts to a loss of the main cooling fan.

With an inverter unit consisting of frame R8i inverter modules, it may be possible to continue operation even if a cooling fan of an inverter module stops. See the description of the parameter.

### **Custom motor current fault limit (parameter [31.42](#))**

The control program sets a motor current limit based on drive hardware. In most cases, the default value is appropriate. However, a lower limit can be manually set by the user, for example, to protect a permanent magnet motor from demagnetization.

### **Local control loss detection (parameter [49.05](#))**

The parameter selects how the drive reacts to a control panel or PC tool communication break.

---

## Diagnostics

### ■ Fault and warning messages, data logging

See chapter [Fault tracing](#) (page 487).

### ■ Signal supervision

Three signals can be selected to be supervised by this function. Whenever a supervised signal exceeds or falls below predefined limits, a bit in [32.01 Supervision status](#) is activated, and a warning or fault generated. The contents of the message can be edited on the control panel by selecting **Menu - Settings - Edit texts**.

The supervised signal is low-pass filtered. The supervision operates on a 2 ms time level. The configuration parameters are scanned for changes on a 10 ms time level.

### Settings

Parameter group [32 Supervision](#) (page 273).

### ■ Maintenance timers and counters

The program has six different maintenance timers or counters that can be configured to generate a warning when a pre-defined limit is reached. The contents of the message can be edited on the control panel by selecting **Menu - Settings - Edit texts**.

The timer/counter can be set to monitor any parameter. This feature is especially useful as a service reminder.

There are three types of counters:

- On-time timers. Measures the time a binary source (for example, a bit in a status word) is on.
- Signal edge counters. The counter is incremented whenever the monitored binary source changes state.
- Value counters. The counter measures, by integration, the monitored parameter. A warning is given when the calculated area below the signal peak exceeds a user-defined limit.

### Settings

Parameter group [33 Generic timer & counter](#) (page 276).

---

## ■ Energy saving calculators

This feature consists of the following functionalities:

- An energy optimizer that adjusts the motor flux in such a way that the total system efficiency is maximized
- A counter that monitors used and saved energy by the motor and displays them in kWh, currency or volume of CO<sub>2</sub> emissions, and
- A load analyzer showing the load profile of the drive (see separate section on page [88](#)).

**Note:** The accuracy of the energy savings calculation is directly dependent on the accuracy of the reference motor power given in parameter [45.19 Comparison power](#).

### Settings

Parameter group [45 Energy efficiency](#) (page [321](#)).

## ■ Load analyzer

### Peak value logger

The user can select a signal to be monitored by a peak value logger. The logger records the peak value of the signal along with the time the peak occurred, as well as motor current, DC voltage and motor speed at the time of the peak. The peak value is sampled at 2 ms intervals.

### Amplitude loggers

The control program has two amplitude loggers.

For amplitude logger 2, the user can select a signal to be sampled at 200 ms intervals, and specify a value that corresponds to 100%. The collected samples are sorted into 10 read-only parameters according to their amplitude. Each parameter represents an amplitude range 10 percentage points wide, and displays the percentage of the collected samples that have fallen within that range. Note that the lowest range also contains the negative values (if any), while the highest range also contains the values above 100%.

---



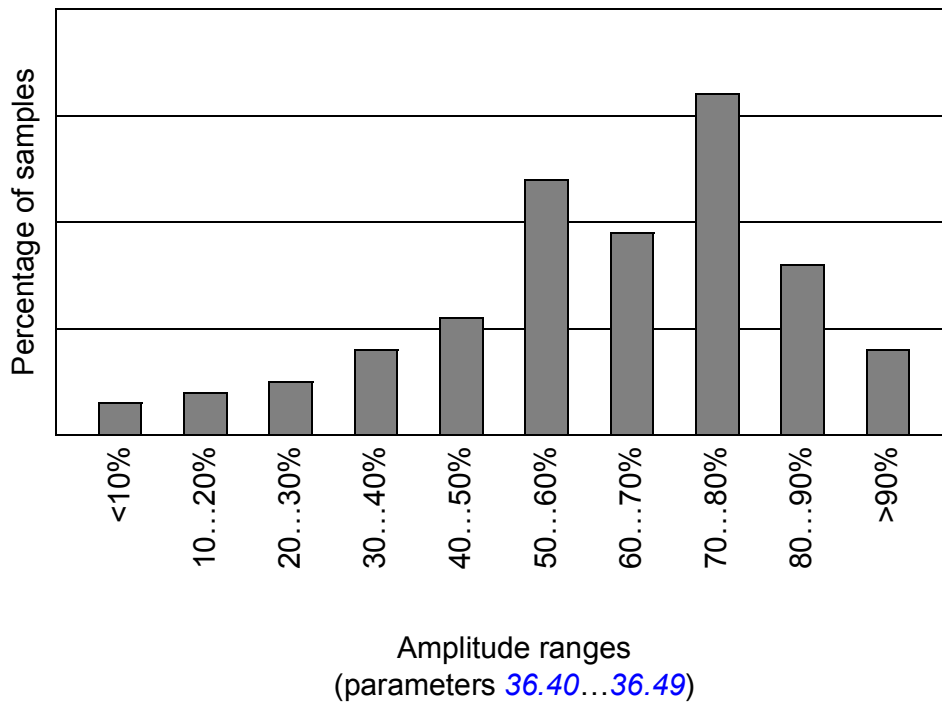

Amplitude logger 1 is fixed to monitor motor current, and cannot be reset. With amplitude logger 1, 100% corresponds to the maximum output current of the drive ( $I_{\max}$ , as given in the hardware manual). The measured current is logged continuously. The distribution of samples is shown by parameters [36.20](#)...[36.29](#).

## Settings

Parameter group [36 Load analyzer](#) (page [294](#)).

## Miscellaneous

### ■ User parameter sets

The drive supports four user parameter sets that can be saved to the permanent memory and recalled using drive parameters. It is also possible to use digital inputs to switch between user parameter sets.

A user parameter set contains all editable values in parameter groups 10...99 except

- forced I/O values such as parameters [10.03 DI force selection](#) and [10.04 DI force data](#)
- I/O extension module settings (groups 14...16)
- fieldbus communication enable parameters ([50.01 FBA A enable](#) and [50.31 FBA B enable](#))
- other fieldbus communication settings (groups 51...56 and 58)
- encoder configuration settings (groups 92...93), and
- parameter [95.01 Supply voltage](#).

As the motor settings are included in the user parameter sets, make sure the settings correspond to the motor used in the application before recalling a user set. In an application where different motors are used with the drive, the motor ID run needs to be performed with each motor and the results saved to different user sets. The appropriate set can then be recalled when the motor is switched.

### Settings

Parameters [96.10...96.13](#) (page [409](#)).

### ■ Parameter checksum calculation

A parameter checksum can be calculated from a user-definable set of parameters to monitor changes in the drive configuration. The calculated checksum is compared to 1...4 reference checksums; in case of a mismatch, an event (a pure event, warning or fault) is generated.

By default, the set of parameters included in the calculation contain most parameters with the exception of

- actual signals
- parameter group [47 Data storage](#)
- parameters that are activated to validate new settings (such as [51.27](#) and [96.07](#))
- parameters that are not saved to the flash memory (such as [96.24...96.26](#))
- parameters that are internally calculated from others (such as [98.09...98.14](#)).
- dynamic parameters (eg. parameters that vary according to hardware), and
- application program parameters.

The default set can be edited using the Drive customizer PC tool.

---

## Settings

Parameters [96.53...96.59](#) (page [413](#)).

### ■ User lock

For better cybersecurity, it is highly recommended that you set a master pass code to prevent eg. the changing of parameter values and/or the loading of firmware and other files.



**WARNING!** ABB will not be liable for damages or losses caused by the failure to activate the user lock using a new pass code. See [Cybersecurity disclaimer](#) (page [15](#)).

---

To activate the user lock for the first time,

- Enter the default pass code, 10000000, into [96.02 Pass code](#). This will make parameters [96.100...96.102](#) visible.
- Enter a new pass code into [96.100 Change user pass code](#). Always use eight digits; if using Drive composer, finish with Enter.
- Confirm the new pass code in [96.101 Confirm user pass code](#).



**WARNING!** Store the pass code in a safe place – the user lock cannot be opened even by ABB if the pass code is lost.

---

- In [96.102 User lock functionality](#), define the actions that you want to prevent (we recommend you select all the actions unless otherwise required by the application).
- Enter an invalid (random) pass code into [96.02 Pass code](#).
- Activate [96.08 Control board boot](#), or cycle the power to the control unit.
- Check that parameters [96.100...96.102](#) are hidden. If they are not, enter another random pass code into [96.02](#).

To reopen the lock, enter your pass code into [96.02 Pass code](#). This will again make parameters [96.100...96.102](#) visible.

## Settings

Parameters [96.02](#) (page [406](#)) and [96.100...96.102](#) (page [415](#)).

### ■ Data storage parameters

Twenty-four (sixteen 32-bit, eight 16-bit) parameters are reserved for data storage. These parameters are unconnected by default and can be used for eg. linking, testing and commissioning purposes. They can be written to and read from using other parameters' source or target selections.

---

Note that “*Analog src*” type parameters (see page 431) expect a 32-bit real (floating point) source – in other words, parameters 47.01...47.08 can be used as a value source of other parameters while 47.11...47.28 cannot.

To use a 16-bit integer (received in DDCS data sets) as the source of another parameter, write the value into one of the “real32” type storage parameters (47.01...47.08). Select the storage parameter as the source, and define a suitable scaling method between the 16-bit and 32-bit values in parameters 47.31...47.38.

## Settings

Parameter group 47 *Data storage* (page 328).

### ■ Reduced run function

A “reduced run” function is available for inverter units consisting of parallel-connected inverter modules. The function makes it possible to continue operation with limited current even if one (or more) module is out of service, for example, because of maintenance work. In principle, reduced run is possible with only one module, but the physical requirements of operating the motor still apply; for example, the modules remaining in use must be able to provide the motor with enough magnetizing current.

### Activation of the reduced run function

**Note:** For cabinet-built drives, the wiring accessories and the air baffle needed during the procedure are available from ABB, and are included in the delivery.



**WARNING!** Follow the safety instructions provided for the drive or inverter unit in question.

---

1. Disconnect the supply voltage and all auxiliary voltages from the drive/inverter unit.
  2. If the inverter control unit is powered from the faulty module, install an extension to the wiring and connect it to one of the remaining modules.
  3. Remove the module to be serviced from its bay. See the appropriate hardware manual for instructions.
  4. If the Safe torque off (STO) function is in use, install jumpering in the STO wiring in place of the missing module (unless the module was the last on the chain).
  5. Install an air baffle to the top module guide to block the airflow through the empty module bay.
  6. In case the inverter unit has a DC switch with a charging circuit, disable the appropriate channel on the xSFC-xx charging controller.
-

7. Switch on the power to the drive/inverter unit.
8. Enter the number of inverter modules present into parameter [95.13 Reduced run mode](#).
9. Reset all faults and start the drive/inverter unit. The maximum current is now automatically limited according to the new inverter configuration. A mismatch between the number of detected modules ([95.14](#)) and the value set in [95.13](#) will generate a fault.

After all modules have been reinstalled, parameter [95.13 Reduced run mode](#) must be reset to 0 to disable the reduced run function. In case the inverter is equipped with a charging circuit, the charging monitoring must be reactivated for all modules. If the Safe torque off (STO) function is in use, an acceptance test must be performed (see the hardware manual of the drive/inverter unit for instructions).

## Settings

Parameters [06.17](#) (page [131](#)) and [95.13...95.14](#) (page [403](#)).

### ■ du/dt filter support

With an external du/dt filter connected to the output of the drive, bit 13 of [95.20 HW options word 1](#) must be switched on. The setting limits the output switching frequency, and forces the drive/inverter module fan to full speed. Note that the setting is not to be activated with inverter modules with internal du/dt filters.

## Settings

Parameter [95.20 HW options word 1](#) (page [404](#)).

### ■ Sine filter support

The control program has a setting that enables the use of sine filters (available separately from ABB and others).

With an ABB sine filter connected to the output of the drive, bit 1 of [95.15 Special HW settings](#) must be switched on. The setting limits the switching and output frequencies to

- prevent the drive from operating at filter resonance frequencies, and
- protect the filter from overheating.

With a custom sine filter, bit 3 of [95.15 Special HW settings](#) must be switched on. (The setting does not limit the output frequency.) Additional parameters must be set according to the properties of the filter as listed below.

## Settings

For both ABB and custom filters: Parameter [95.15 Special HW settings](#) (page [403](#)).

---

## 94 Program features

For custom filters: Parameters [97.01 Switching frequency reference](#), [97.02 Minimum switching frequency](#) (page [417](#)), [99.18 Sine filter inductance](#) and [99.19 Sine filter capacitance](#) (page [429](#)).

---



# Application macros

---

## What this chapter contains

This chapter describes the intended use, operation and default control connections of the application macros.

More information on the connectivity of the control unit is given in the *Hardware manual* of the drive.

## General

Application macros are sets of default parameter values suitable for the application in question. When starting up the drive, the user typically selects the best-suited application macro as a starting point, then makes any necessary changes to tailor the settings to the application. This usually results in a much lower number of user edits compared to the traditional way of programming a drive.

Application macros can be selected by parameter [96.04 Macro select](#). User parameter sets are managed by the parameters in group [96 System](#).

---

## Factory macro

The Factory macro is suited to relatively straightforward speed control applications such as conveyors, pumps and fans, and test benches.

The drive is speed-controlled with the reference signal connected to analog input AI1. The start/stop commands are given through digital input DI1; running direction is determined by DI2. This macro uses control location EXT1.

Faults are reset through digital input DI3.

DI4 switches between acceleration/deceleration time sets 1 and 2. The acceleration and deceleration times, as well as ramp shapes, are defined by parameters [23.12...23.19](#).

DI5 activates constant speed 1.

### ■ **Default parameter settings for the Factory macro**

The default parameter settings for the Factory macro are listed under [Parameter listing](#) (page [115](#)).

---



■ Default control connections for the Factory macro

|  |  |   |
|--|--|---|
| <b>XPOW</b> External power input               |  |   |
| <b>1</b>                                       | +24VI  | 24 V DC, 2 A  |
| <b>2</b>                                       | GND  |   |
| <b>XAI</b> Reference voltage and analog inputs |  |   |
| <b>1</b>                                       | +VREF  | 10 V DC, $R_L$ 1...10 kohm  |
| <b>2</b>                                       | -VREF  | -10 V DC, $R_L$ 1...10 kohm   |
| <b>3</b>                                       | AGND   | Ground  |
| <b>4</b>                                       | AI1+   | <b>Speed reference</b><br>0(2)...10 V, $R_{in} > 200$ kohm                |
| <b>5</b>                                       | AI1-   |   |
| <b>6</b>                                       | AI2+   | By default not in use.  |
| <b>7</b>                                       | AI2-   | 0(4)...20 mA, $R_{in} = 100$ ohm  |
| <b>XAO</b> Analog outputs                      |  |   |
| <b>1</b>                                       | AO1  | <b>Motor speed rpm</b>  |
| <b>2</b>                                       | AGND   | 0...20 mA, $R_L < 500$ ohm  |
| <b>3</b>                                       | AO2  | <b>Motor current</b>  |
| <b>4</b>                                       | AGND   | 0...20 mA, $R_L < 500$ ohm  |
| <b>XD2D</b> Drive-to-drive link                |  |   |
| <b>1</b>                                       | B  | Master/follower, drive-to-drive or embedded fieldbus interface connection |
| <b>2</b>                                       | A  |   |
| <b>3</b>                                       | BGND   |   |
| <b>XRO1, XRO2, XRO3</b> Relay outputs          |  |   |
| <b>1</b>                                       | NC   | <b>Ready run</b><br>250 V AC / 30 V DC<br>2 A                             |
| <b>2</b>                                       | COM  |   |
| <b>3</b>                                       | NO   |   |
| <b>1</b>                                       | NC   | <b>Running</b><br>250 V AC / 30 V DC<br>2 A                               |
| <b>2</b>                                       | COM  |   |
| <b>3</b>                                       | NO   |   |
| <b>1</b>                                       | NC   | <b>Fault (-1)</b><br>250 V AC / 30 V DC<br>2 A                            |
| <b>2</b>                                       | COM  |   |
| <b>3</b>                                       | NO   |   |
| <b>XD24</b> Digital interlock                  |  |   |
| <b>1</b>                                       | DIIL   | Run enable  |
| <b>2</b>                                       | +24VD  | +24 V DC 200 mA   |
| <b>3</b>                                       | DICOM  | Digital input ground  |
| <b>4</b>                                       | +24VD  | +24 V DC 200 mA   |
| <b>5</b>                                       | DIOGND   | Digital input/output ground   |
| <b>XDIO</b> Digital input/outputs              |  |   |
| <b>1</b>                                       | DIO1   | <i>Output: Ready run</i>  |
| <b>2</b>                                       | DIO2   | <i>Output: Running</i>  |
| <b>XDI</b> Digital inputs                      |  |   |
| <b>1</b>                                       | DI1  | Stop (0) / Start (1)  |
| <b>2</b>                                       | DI2  | Forward (0) / Reverse (1)   |
| <b>3</b>                                       | DI3  | Reset   |
| <b>4</b>                                       | DI4  | Acc/Dec time set 1 (0) / set 2 (1)  |
| <b>5</b>                                       | DI5  | Constant speed 1 (1 = On)   |
| <b>6</b>                                       | DI6  | By default, not in use.   |
| <b>XSTO</b>                                    | Safe torque off circuits must be closed for the drive to start. See <i>Hardware manual</i> of drive. |   |
| <b>X12</b>                                     | Safety options connection  |   |
| <b>X13</b>                                     | Control panel connection   |   |
| <b>X205</b>                                    | Memory unit connection   |   |

## Hand/Auto macro

The Hand/Auto macro is suited to speed control applications where two external control devices are used.

The drive is speed-controlled from the external control locations EXT1 (Hand control) and EXT2 (Auto control). The selection between the control locations is done through digital input DI3.

The start/stop signal for EXT1 is connected to DI1 while running direction is determined by DI2. For EXT2, start/stop commands are given through DI6, the direction through DI5.

The reference signals for EXT1 and EXT2 are connected to analog inputs AI1 and AI2 respectively.

A constant speed (by default, 300 rpm) can be activated through DI4.

### ■ Default parameter settings for the Hand/Auto macro

Below is a listing of default parameter values that differ from those listed for the Factory macro in [Parameter listing](#) (page 115).

| Parameter |                               | Hand/Auto macro default           |
|-----------|-------------------------------|-----------------------------------|
| No.       | Name                          |                                   |
| 12.30     | <i>AI2 scaled at AI2 max</i>  | 1500.000                          |
| 19.11     | <i>Ext1/Ext2 selection</i>    | <i>DI3</i>                        |
| 20.06     | <i>Ext2 commands</i>          | <i>In1 Start; In2 Dir</i>         |
| 20.08     | <i>Ext2 in1 source</i>        | <i>DI6</i>                        |
| 20.09     | <i>Ext2 in2 source</i>        | <i>DI5</i>                        |
| 20.12     | <i>Run enable 1 source</i>    | <i>DI4</i>                        |
| 22.12     | <i>Speed ref2 source</i>      | <i>AI2 scaled</i>                 |
| 22.14     | <i>Speed ref1/2 selection</i> | <i>Follow Ext1/Ext2 selection</i> |
| 22.22     | <i>Constant speed sel1</i>    | <i>DI4</i>                        |
| 23.11     | <i>Ramp set selection</i>     | <i>Acc/Dec time 1</i>             |
| 31.11     | <i>Fault reset selection</i>  | <i>Not selected</i>               |

■ Default control connections for the Hand/Auto macro

|  |  |   |
|--|--|---|
| <b>XPOW</b> External power input               |  |   |
| <b>1</b>                                       | +24VI  | 24 V DC, 2 A  |
| <b>2</b>                                       | GND  |   |
| <b>XAI</b> Reference voltage and analog inputs |  |   |
| <b>1</b>                                       | +VREF  | 10 V DC, $R_L$ 1...10 kohm  |
| <b>2</b>                                       | -VREF  | -10 V DC, $R_L$ 1...10 kohm   |
| <b>3</b>                                       | AGND   | Ground  |
| <b>4</b>                                       | AI1+   | <b>Speed reference (Hand)</b><br>0(2)...10 V, $R_{in} > 200$ kohm         |
| <b>5</b>                                       | AI1-   |   |
| <b>6</b>                                       | AI2+   | <b>Speed reference (Auto)</b><br>0(4)...20 mA, $R_{in} = 100$ ohm         |
| <b>7</b>                                       | AI2-   |   |
| <b>XAO</b> Analog outputs                      |  |   |
| <b>1</b>                                       | AO1  | <b>Motor speed rpm</b><br>0...20 mA, $R_L < 500$ ohm                      |
| <b>2</b>                                       | AGND   | <b>Motor current</b><br>0...20 mA, $R_L < 500$ ohm                        |
| <b>3</b>                                       | AO2  |   |
| <b>4</b>                                       | AGND   |   |
| <b>XD2D</b> Drive-to-drive link                |  |   |
| <b>1</b>                                       | B  | Master/follower, drive-to-drive or embedded fieldbus interface connection |
| <b>2</b>                                       | A  |   |
| <b>3</b>                                       | BGND   |   |
| <b>XRO1, XRO2, XRO3</b> Relay outputs          |  |   |
| <b>1</b>                                       | NC   | <b>Ready run</b><br>250 V AC / 30 V DC<br>2 A                             |
| <b>2</b>                                       | COM  |   |
| <b>3</b>                                       | NO   |   |
| <b>1</b>                                       | NC   | <b>Running</b><br>250 V AC / 30 V DC<br>2 A                               |
| <b>2</b>                                       | COM  |   |
| <b>3</b>                                       | NO   |   |
| <b>1</b>                                       | NC   | <b>Fault (-1)</b><br>250 V AC / 30 V DC<br>2 A                            |
| <b>2</b>                                       | COM  |   |
| <b>3</b>                                       | NO   |   |
| <b>XD24</b> Digital interlock                  |  |   |
| <b>1</b>                                       | DIIL   | Run enable  |
| <b>2</b>                                       | +24VD  | +24 V DC 200 mA   |
| <b>3</b>                                       | DICOM  | Digital input ground  |
| <b>4</b>                                       | +24VD  | +24 V DC 200 mA   |
| <b>5</b>                                       | DIOGND   | Digital input/output ground   |
| <b>XDIO</b> Digital input/outputs              |  |   |
| <b>1</b>                                       | DIO1   | <b>Output: Ready run</b>  |
| <b>2</b>                                       | DIO2   | <b>Output: Running</b>  |
| <b>XDI</b> Digital inputs                      |  |   |
| <b>1</b>                                       | DI1  | Stop (0) / Start (1) – Hand   |
| <b>2</b>                                       | DI2  | Forward (0) / Reverse (1) – Hand  |
| <b>3</b>                                       | DI3  | Hand (0) / Auto (1)   |
| <b>4</b>                                       | DI4  | Constant speed 1 (1 = On)   |
| <b>5</b>                                       | DI5  | Forward (0) / Reverse (1) – Auto  |
| <b>6</b>                                       | DI6  | Stop (0) / Start (1) – Auto   |
| <b>XSTO</b>                                    | Safe torque off circuits must be closed for the drive to start. See <i>Hardware manual</i> of drive. |   |
| <b>X12</b>                                     | Safety options connection  |   |
| <b>X13</b>                                     | Control panel connection   |   |
| <b>X205</b>                                    | Memory unit connection   |   |

## **PID control macro**

The PID control macro is suitable for process control applications, for example closed-loop pressure, level or flow control systems such as

- pressure boost pumps of municipal water supply systems
- level-controlling pumps of water reservoirs
- pressure boost pumps of district heating systems
- material flow control on a conveyor line.

The process reference signal is connected to analog input AI1 and the process feedback signal to AI2. Alternatively, a direct speed reference can be given to the drive through AI1. Then the PID controller is bypassed and the drive no longer controls the process variable.

Selection between direct speed control (control location EXT1) and process variable control (EXT2) is done through digital input DI3.

The stop/start signals for EXT1 and EXT2 are connected to DI1 and DI6 respectively.

A constant speed (by default, 300 rpm) can be activated through DI4.

**Note:** When commissioning the PID loop, it is useful to run the motor in speed control first using EXT1; this allows testing of the PID feedback polarity and scaling. Once the feedback has been proven, the PID loop can be “closed” by switching to EXT2.

## ■ Default parameter settings for the PID control macro

Below is a listing of default parameter values that differ from those listed for the Factory macro in [Parameter listing](#) (page 115).

| Parameter |                                     | PID control macro default         |
|-----------|-------------------------------------|-----------------------------------|
| No.       | Name                                |                                   |
| 12.27     | <i>AI2 min</i>                      | 4.000                             |
| 19.11     | <i>Ext1/Ext2 selection</i>          | <i>DI3</i>                        |
| 20.01     | <i>Ext1 commands</i>                | <i>In1 Start</i>                  |
| 20.04     | <i>Ext1 in2 source</i>              | <i>Not selected</i>               |
| 20.06     | <i>Ext2 commands</i>                | <i>In1 Start</i>                  |
| 20.08     | <i>Ext2 in1 source</i>              | <i>DI6</i>                        |
| 20.12     | <i>Run enable 1 source</i>          | <i>DI5</i>                        |
| 22.12     | <i>Speed ref2 source</i>            | <i>PID</i>                        |
| 22.22     | <i>Constant speed sel1</i>          | <i>DI4</i>                        |
| 23.11     | <i>Ramp set selection</i>           | <i>Acc/Dec time 1</i>             |
| 31.11     | <i>Fault reset selection</i>        | <i>Not selected</i>               |
| 40.07     | <i>Set 1 PID operation mode</i>     | <i>On when drive running</i>      |
| 40.08     | <i>Set 1 feedback 1 source</i>      | <i>AI2 scaled</i>                 |
| 40.11     | <i>Set 1 feedback filter time</i>   | 0.040 s                           |
| 40.35     | <i>Set 1 derivation filter time</i> | 1.0 s                             |
| 40.60     | <i>Set 1 PID activation source</i>  | <i>Follow Ext1/Ext2 selection</i> |

**Note:** The macro selection does not affect parameter group [41 Process PID set 2](#).

■ Default control connections for the PID control macro

|             |  |  |   |
|-------------|--|--|---|
|             |  | <b>XPOW</b> External power input               |   |
|             | <b>1</b>   | +24VI  | 24 V DC, 2 A  |
|             | <b>2</b>   | GND  |   |
|             |  | <b>XAI</b> Reference voltage and analog inputs |   |
|             | <b>1</b>   | +VREF  | 10 V DC, $R_L$ 1...10 kohm  |
|             | <b>2</b>   | -VREF  | -10 V DC, $R_L$ 1...10 kohm   |
|             | <b>3</b>   | AGND   | Ground  |
|             | <b>4</b>   | AI1+   | <b>Speed reference</b>  |
|             | <b>5</b>   | AI1-   | 0(2)...10 V, $R_{in} > 200$ kohm  |
|             | <b>6</b>   | AI2+   | <b>Process feedback*</b>  |
|             | <b>7</b>   | AI2-   | 0(4)...20 mA, $R_{in} = 100$ ohm  |
|             |  | <b>XAO</b> Analog outputs                      |   |
|             | <b>1</b>   | AO1  | <b>Motor speed rpm</b>  |
|             | <b>2</b>   | AGND   | 0...20 mA, $R_L < 500$ ohm  |
|             | <b>3</b>   | AO2  | <b>Motor current</b>  |
|             | <b>4</b>   | AGND   | 0...20 mA, $R_L < 500$ ohm  |
|             |  | <b>XD2D</b> Drive-to-drive link                |   |
|             | <b>1</b>   | B  | Master/follower, drive-to-drive or embedded fieldbus interface connection |
|             | <b>2</b>   | A  |   |
|             | <b>3</b>   | BGND   |   |
|             |  | <b>XRO1, XRO2, XRO3</b> Relay outputs          |   |
|             | <b>1</b>   | NC   | <b>Ready run</b><br>250 V AC / 30 V DC<br>2 A                             |
|             | <b>2</b>   | COM  |   |
|             | <b>3</b>   | NO   |   |
|             | <b>1</b>   | NC   | <b>Running</b><br>250 V AC / 30 V DC<br>2 A                               |
|             | <b>2</b>   | COM  |   |
|             | <b>3</b>   | NO   |   |
|             | <b>1</b>   | NC   | <b>Fault (-1)</b><br>250 V AC / 30 V DC<br>2 A                            |
|             | <b>2</b>   | COM  |   |
|             | <b>3</b>   | NO   |   |
|             |  | <b>XD24</b> Digital interlock                  |   |
|             | <b>1</b>   | DIIL   | Digital interlock. By default, not in use.                                |
|             | <b>2</b>   | +24VD  | +24 V DC 200 mA   |
|             | <b>3</b>   | DICOM  | Digital input ground  |
|             | <b>4</b>   | +24VD  | +24 V DC 200 mA   |
|             | <b>5</b>   | DIOGND   | Digital input/output ground   |
|             |  | <b>XDIO</b> Digital input/outputs              |   |
|             | <b>1</b>   | DIO1   | <i>Output: Ready run</i>  |
|             | <b>2</b>   | DIO2   | <i>Output: Running</i>  |
|             |  | <b>XDI</b> Digital inputs                      |   |
|             | <b>1</b>   | DI1  | Stop (0) / Start (1) – Speed control                                      |
|             | <b>2</b>   | DI2  | By default, not in use.   |
|             | <b>3</b>   | DI3  | Speed control (0) / Process control (1)                                   |
|             | <b>4</b>   | DI4  | Constant speed 1 (1 = On)   |
|             | <b>5</b>   | DI5  | Run enable (1 = On)   |
|             | <b>6</b>   | DI6  | Stop (0) / Start (1) – Process control                                    |
| <b>XSTO</b> | Safe torque off circuits must be closed for the drive to start. See <i>Hardware manual</i> of drive. |  |   |
| <b>X12</b>  | Safety options connection  |  |   |
| <b>X13</b>  | Control panel connection   |  |   |
| <b>X205</b> | Memory unit connection   |  |   |

\*For sensor connection examples, see page 103.

■ Sensor connection examples for the PID control macro

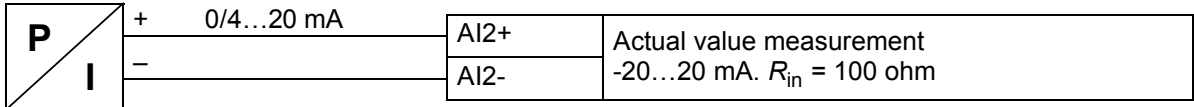

**Note:** The sensor must be powered externally.

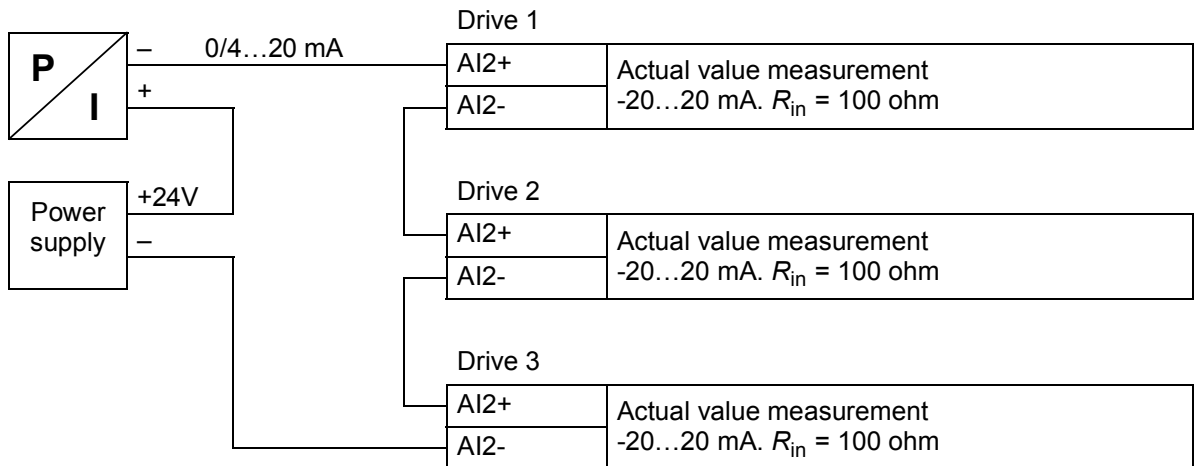
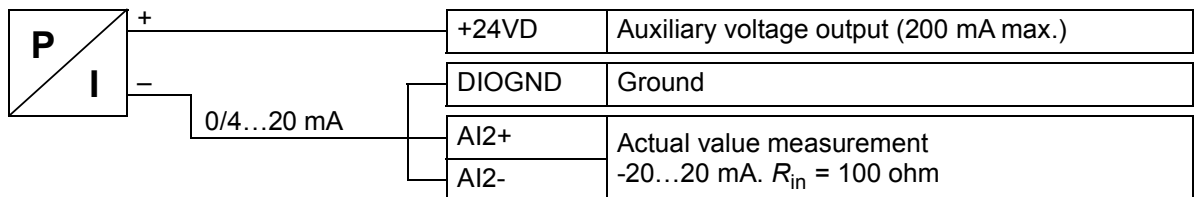
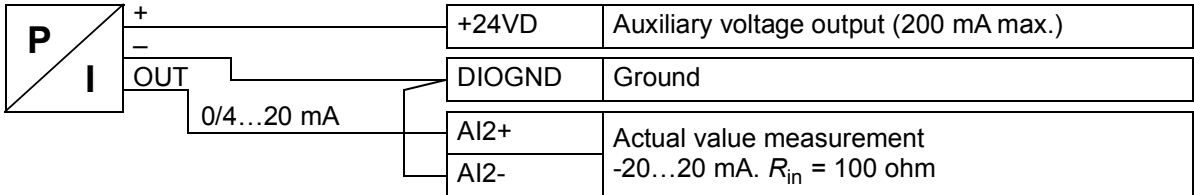

## Torque control macro

This macro is used in applications in which torque control of the motor is required. These are typically tension applications, where a particular tension needs to be maintained in the mechanical system.

Torque reference is given through analog input AI2, typically as a current signal in the range of 0...20 mA (corresponding to 0...100% of rated motor torque).

The start/stop signal is connected to digital input DI1. The direction is determined by DI2. Through digital input DI3, it is possible to select speed control (EXT1) instead of torque control (EXT2). As with the PID control macro, speed control can be used for commissioning the system and checking the motor direction.

It is also possible to change the control to local (control panel or PC tool) by pressing the Loc/Rem key. By default, the local reference is speed; if a torque reference is required, the value of parameter [19.16 Local control mode](#) should be changed to *Torque*.

A constant speed (by default, 300 rpm) can be activated through DI4. DI5 switches between acceleration/deceleration time sets 1 and 2. The acceleration and deceleration times, as well as ramp shapes, are defined by parameters [23.12...23.19](#).



### ■ Default parameter settings for the Torque control macro

Below is a listing of default parameter values that differ from those listed for the Factory macro in [Parameter listing](#) (page 115).

| Parameter             |   | Torque control macro default |
|-----------------------|---|------------------------------|
| No.                   | Name                                    |                              |
| <a href="#">19.11</a> | <a href="#">Ext1/Ext2 selection</a>     | <i>DI3</i>                   |
| <a href="#">19.14</a> | <a href="#">Ext2 control mode</a>       | <i>Torque</i>                |
| <a href="#">20.02</a> | <a href="#">Ext1 start trigger type</a> | <i>Level</i>                 |
| <a href="#">20.06</a> | <a href="#">Ext2 commands</a>           | <i>In1 Start; In2 Dir</i>    |
| <a href="#">20.07</a> | <a href="#">Ext2 start trigger type</a> | <i>Level</i>                 |
| <a href="#">20.08</a> | <a href="#">Ext2 in1 source</a>         | <i>DI1</i>                   |
| <a href="#">20.09</a> | <a href="#">Ext2 in2 source</a>         | <i>DI2</i>                   |
| <a href="#">20.12</a> | <a href="#">Run enable 1 source</a>     | <i>DI6</i>                   |
| <a href="#">22.22</a> | <a href="#">Constant speed sel1</a>     | <i>DI4</i>                   |
| <a href="#">23.11</a> | <a href="#">Ramp set selection</a>      | <i>DI5</i>                   |
| <a href="#">26.11</a> | <a href="#">Torque ref1 source</a>      | <i>AI2 scaled</i>            |
| <a href="#">31.11</a> | <a href="#">Fault reset selection</a>   | <i>Not selected</i>          |



■ Default control connections for the Torque control macro

|  |  |  |
|--|--|--|
| <b>XPOW</b> External power input               |  |  |
| 1  | +24VI  | 24 V DC, 2 A   |
| 2  | GND  |  |
| <b>XAI</b> Reference voltage and analog inputs |  |  |
| 1  | +VREF  | 10 V DC, $R_L$ 1...10 kohm   |
| 2  | -VREF  | -10 V DC, $R_L$ 1...10 kohm  |
| 3  | AGND   | Ground   |
| 4  | AI1+   | <b>Speed reference</b><br>0(2)...10 V, $R_{in} > 200$ kohm   |
| 5  | AI1-   |  |
| 6  | AI2+   | <b>Torque reference</b><br>0(4)...20 mA, $R_{in} = 100$ ohm  |
| 7  | AI2-   |  |
| <b>XAO</b> Analog outputs                      |  |  |
| 1  | AO1  | <b>Motor speed rpm</b><br>0...20 mA, $R_L < 500$ ohm   |
| 2  | AGND   | <b>Motor current</b><br>0...20 mA, $R_L < 500$ ohm   |
| 3  | AO2  |  |
| 4  | AGND   |  |
| <b>XD2D</b> Drive-to-drive link                |  |  |
| 1  | B  | Master/follower, drive-to-drive or embedded fieldbus interface connection  |
| 2  | A  |  |
| 3  | BGND   |  |
| <b>XRO1, XRO2, XRO3</b> Relay outputs          |  |  |
| 1  | NC   |  <b>Ready run</b><br>250 V AC / 30 V DC<br>2 A   |
| 2  | COM  |  |
| 3  | NO   |  |
| 1  | NC   |  <b>Running</b><br>250 V AC / 30 V DC<br>2 A    |
| 2  | COM  |  |
| 3  | NO   |  |
| 1  | NC   |  <b>Fault (-1)</b><br>250 V AC / 30 V DC<br>2 A |
| 2  | COM  |  |
| 3  | NO   |  |
| <b>XD24</b> Digital interlock                  |  |  |
| 1  | DIIL   | Digital interlock. By default, not in use.   |
| 2  | +24VD  | +24 V DC 200 mA  |
| 3  | DICOM  | Digital input ground   |
| 4  | +24VD  | +24 V DC 200 mA  |
| 5  | DIOGND   | Digital input/output ground  |
| <b>XDIO</b> Digital input/outputs              |  |  |
| 1  | DIO1   | <i>Output: Ready run</i>   |
| 2  | DIO2   | <i>Output: Running</i>   |
| <b>XDI</b> Digital inputs                      |  |  |
| 1  | DI1  | Stop (0) / Start (1)   |
| 2  | DI2  | Forward (0) / Reverse (1)  |
| 3  | DI3  | Speed control (0) / Torque control (1)   |
| 4  | DI4  | Constant speed 1 (1 = On)  |
| 5  | DI5  | Acc/Dec time set 1 (0) / set 2 (1)   |
| 6  | DI6  | Run enable (1 = On)  |
| <b>XSTO</b>                                    | Safe torque off circuits must be closed for the drive to start. See <i>Hardware manual</i> of drive. |  |
| <b>X12</b>                                     | Safety options connection  |  |
| <b>X13</b>                                     | Control panel connection   |  |
| <b>X205</b>                                    | Memory unit connection   |  |

## Sequential control macro

The Sequential control macro is suited for speed control applications in which a speed reference, multiple constant speeds, and two acceleration and deceleration ramps can be used.

Only EXT1 is used in this macro.

The macro offers seven preset constant speeds which can be activated by digital inputs DI4...DI6 (see parameter [22.21 Constant speed function](#)). An external speed reference can be given through analog input AI1. The reference is active only when no constant speed is activated (digital inputs DI4...DI6 are all off). Operational commands can also be given from the control panel.

The start/stop commands are given through digital input DI1; running direction is determined by DI2.

Two acceleration/deceleration ramps are selectable through DI3. The acceleration and deceleration times, as well as ramp shapes, are defined by parameters [23.12...23.19](#).

### ■ Operation diagram

The figure below shows an example of the use of the macro.

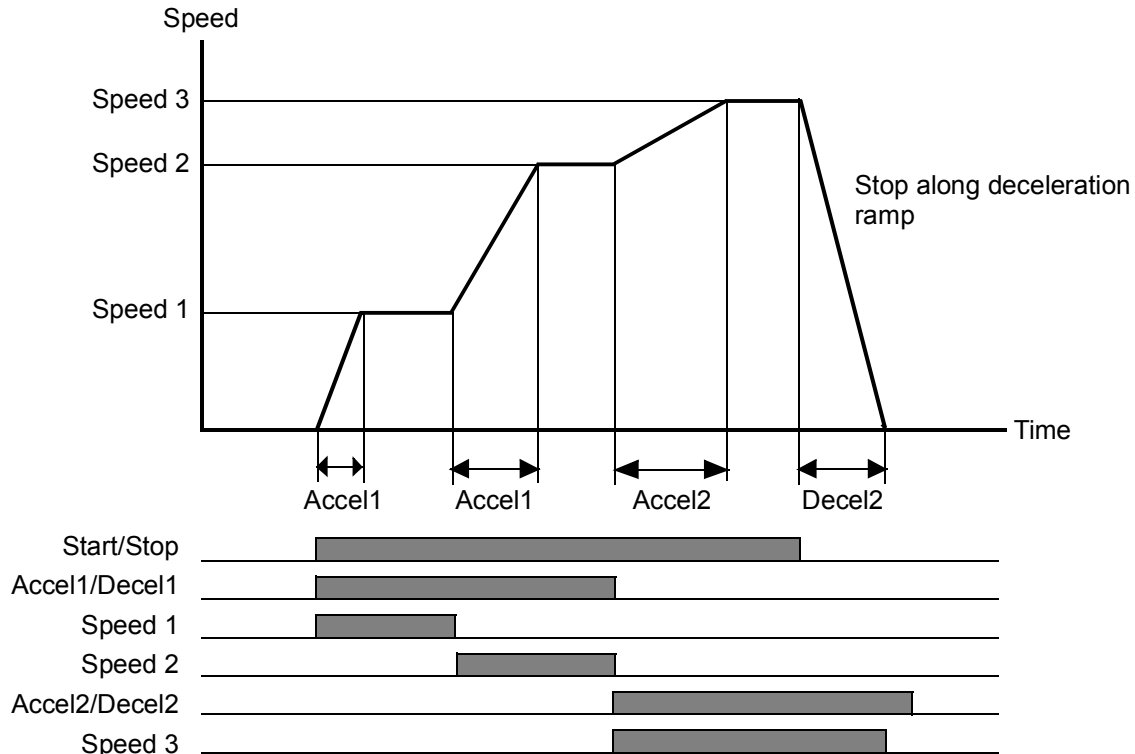

## ■ Selection of constant speeds

By default, constant speeds 1...7 are selected using digital inputs DI4...DI6 as follows:



| DI4 | DI5 | DI6 | Constant speed active                |
|-----|-----|-----|--------------------------------------|
| 0   | 0   | 0   | None (External speed reference used) |
| 1   | 0   | 0   | Constant speed 1                     |
| 0   | 1   | 0   | Constant speed 2                     |
| 1   | 1   | 0   | Constant speed 3                     |
| 0   | 0   | 1   | Constant speed 4                     |
| 1   | 0   | 1   | Constant speed 5                     |
| 0   | 1   | 1   | Constant speed 6                     |
| 1   | 1   | 1   | Constant speed 7                     |

## ■ Default parameter settings for the Sequential control macro

Below is a listing of default parameter values that differ from those listed for the Factory macro in [Parameter listing](#) (page 115).

| Parameter |                                 | Sequential control macro default |
|-----------|---------------------------------|----------------------------------|
| No.       | Name                            |                                  |
| 20.12     | <i>Run enable 1 source</i>      | <i>DI1L</i>                      |
| 21.03     | <i>Stop mode</i>                | <i>Ramp</i>                      |
| 22.21     | <i>Constant speed function</i>  | 01b (Bit 0 = Packed)             |
| 22.22     | <i>Constant speed sel1</i>      | <i>DI4</i>                       |
| 22.23     | <i>Constant speed sel2</i>      | <i>DI5</i>                       |
| 22.24     | <i>Constant speed sel3</i>      | <i>DI6</i>                       |
| 22.27     | <i>Constant speed 2</i>         | 600.00 rpm                       |
| 22.28     | <i>Constant speed 3</i>         | 900.00 rpm                       |
| 22.29     | <i>Constant speed 4</i>         | 1200.00 rpm                      |
| 22.30     | <i>Constant speed 5</i>         | 1500.00 rpm                      |
| 22.31     | <i>Constant speed 6</i>         | 2400.00 rpm                      |
| 22.32     | <i>Constant speed 7</i>         | 3000.00 rpm                      |
| 23.11     | <i>Ramp set selection</i>       | <i>DI3</i>                       |
| 25.06     | <i>Acc comp derivation time</i> | 0.12 s                           |
| 31.11     | <i>Fault reset selection</i>    | <i>Not selected</i>              |

■ Default control connections for the Sequential control macro

|             |  |  |  |
|-------------|--|--|--|
|             |  | <b>XPOW</b> External power input   |  |
| <b>1</b>    | +24VI  | 24 V DC, 2 A   |  |
| <b>2</b>    | GND  |  |  |
|             |  | <b>XAI</b> Reference voltage and analog inputs   |  |
| <b>1</b>    | +VREF  | 10 V DC, $R_L$ 1...10 kohm   |  |
| <b>2</b>    | -VREF  | -10 V DC, $R_L$ 1...10 kohm  |  |
| <b>3</b>    | AGND   | Ground   |  |
| <b>4</b>    | AI1+   | <b>Speed reference</b>   |  |
| <b>5</b>    | AI1-   | 0(2)...10 V, $R_{in} > 200$ kohm   |  |
| <b>6</b>    | AI2+   | By default, not in use.  |  |
| <b>7</b>    | AI2-   | 0(4)...20 mA, $R_{in} = 100$ ohm   |  |
|             |  | <b>XAO</b> Analog outputs  |  |
| <b>1</b>    | AO1  | <b>Motor speed rpm</b>   |  |
| <b>2</b>    | AGND   | 0...20 mA, $R_L < 500$ ohm   |  |
| <b>3</b>    | AO2  | <b>Motor current</b>   |  |
| <b>4</b>    | AGND   | 0...20 mA, $R_L < 500$ ohm   |  |
|             |  | <b>XD2D</b> Drive-to-drive link  |  |
| <b>1</b>    | B  | Master/follower, drive-to-drive or embedded fieldbus interface connection  |  |
| <b>2</b>    | A  |  |  |
| <b>3</b>    | BGND   |  |  |
|             |  | <b>XRO1, XRO2, XRO3</b> Relay outputs  |  |
| <b>1</b>    | NC   |  <b>Ready run</b><br>250 V AC / 30 V DC<br>2 A   |  |
| <b>2</b>    | COM  |  |  |
| <b>3</b>    | NO   |  |  |
| <b>1</b>    | NC   |  <b>Running</b><br>250 V AC / 30 V DC<br>2 A    |  |
| <b>2</b>    | COM  |  |  |
| <b>3</b>    | NO   |  |  |
| <b>1</b>    | NC   |  <b>Fault (-1)</b><br>250 V AC / 30 V DC<br>2 A |  |
| <b>2</b>    | COM  |  |  |
| <b>3</b>    | NO   |  |  |
|             |  | <b>XD24</b> Digital interlock  |  |
| <b>1</b>    | DIIL   | Run enable   |  |
| <b>2</b>    | +24VD  | +24 V DC 200 mA  |  |
| <b>3</b>    | DICOM  | Digital input ground   |  |
| <b>4</b>    | +24VD  | +24 V DC 200 mA  |  |
| <b>5</b>    | DIOGND   | Digital input/output ground  |  |
|             |  | <b>XDIO</b> Digital input/outputs  |  |
| <b>1</b>    | DIO1   | <i>Output: Ready run</i>   |  |
| <b>2</b>    | DIO2   | <i>Output: Running</i>   |  |
|             |  | <b>XDI</b> Digital inputs  |  |
| <b>1</b>    | DI1  | Stop (0) / Start (1)   |  |
| <b>2</b>    | DI2  | Forward (0) / Reverse (1)  |  |
| <b>3</b>    | DI3  | Acc/Dec time set 1 (0) / set 2 (1)   |  |
| <b>4</b>    | DI4  | Constant speed selection (see page 107)  |  |
| <b>5</b>    | DI5  |  |  |
| <b>6</b>    | DI6  |  |  |
| <b>XSTO</b> | Safe torque off circuits must be closed for the drive to start. See <i>Hardware manual</i> of drive. |  |  |
| <b>X12</b>  | Safety options connection  |  |  |
| <b>X13</b>  | Control panel connection   |  |  |
| <b>X205</b> | Memory unit connection   |  |  |

## **Fieldbus control macro**

This application macro is not supported by the current firmware version.





# Parameters

---

## What this chapter contains

The chapter describes the parameters, including actual signals, of the control program.

---

## Terms and abbreviations

| Term          | Definition   |
|---------------|--|
| Actual signal | Type of <i>parameter</i> that is the result of a measurement or calculation by the drive, or contains status information. Most actual signals are read-only, but some (especially counter-type actual signals) can be reset.   |
| Def           | (In the following table, shown on the same row as the parameter name)<br>The default value of a <i>parameter</i> when used in the Factory macro. For information on other macro-specific parameter values, see chapter <i>Application macros</i> (page 95).<br><b>Note:</b> Certain configurations or optional equipment may require specific default values. These are labelled as follows:<br>(95.20 bx) = Default changed or write-protected by parameter 95.20, bit x.         |
| FbEq16        | (In the following table, shown on the same row as the parameter range, or for each selection)<br>16-bit fieldbus equivalent: The scaling between the value shown on the panel and the integer used in communication when a 16-bit value is selected for transmission to an external system.<br>A dash (-) indicates that the parameter is not accessible in 16-bit format.<br>The corresponding 32-bit scalings are listed in chapter <i>Additional parameter data</i> (page 431). |
| Other         | The value is taken from another parameter.<br>Choosing “Other” displays a parameter list in which the user can specify the source parameter.<br><b>Note:</b> The source parameter must be a 32-bit real (floating point) number. To use a 16-bit integer (for example, received from an external device in data sets) as the source, data storage parameters 47.01...47.08 (page 328) can be used.   |
| Other [bit]   | The value is taken from a specific bit in another parameter.<br>Choosing “Other” displays a parameter list in which the user can specify the source parameter and bit.   |
| Parameter     | Either a user-adjustable operating instruction for the drive, or an <i>actual signal</i> .   |
| p.u.          | Per unit   |



## Summary of parameter groups

| Group   | Contents  | Page                |
|---|---|---------------------|
| <a href="#">01 Actual values</a>                | Basic signals for monitoring the drive.   | <a href="#">115</a> |
| <a href="#">03 Input references</a>             | Values of references received from various sources.   | <a href="#">119</a> |
| <a href="#">04 Warnings and faults</a>          | Information on warnings and faults that occurred last.  | <a href="#">120</a> |
| <a href="#">05 Diagnostics</a>                  | Various run-time-type counters and measurements related to drive maintenance.   | <a href="#">127</a> |
| <a href="#">06 Control and status words</a>     | Drive control and status words.   | <a href="#">128</a> |
| <a href="#">07 System info</a>                  | Information on drive hardware, firmware and application program.  | <a href="#">143</a> |
| <a href="#">10 Standard DI, RO</a>              | Configuration of digital inputs and relay outputs.  | <a href="#">145</a> |
| <a href="#">11 Standard DIO, FI, FO</a>         | Configuration of digital input/outputs and frequency inputs/outputs.  | <a href="#">152</a> |
| <a href="#">12 Standard AI</a>                  | Configuration of standard analog inputs.  | <a href="#">157</a> |
| <a href="#">13 Standard AO</a>                  | Configuration of standard analog outputs.   | <a href="#">161</a> |
| <a href="#">14 I/O extension module 1</a>       | Configuration of I/O extension module 1.  | <a href="#">165</a> |
| <a href="#">15 I/O extension module 2</a>       | Configuration of I/O extension module 2.  | <a href="#">184</a> |
| <a href="#">16 I/O extension module 3</a>       | Configuration of I/O extension module 3.  | <a href="#">188</a> |
| <a href="#">19 Operation mode</a>               | Selection of local and external control location sources and operating modes.   | <a href="#">192</a> |
| <a href="#">20 Start/stop/direction</a>         | Start/stop/direction and run/start/jog enable signal source selection; positive/negative reference enable signal source selection.          | <a href="#">194</a> |
| <a href="#">21 Start/stop mode</a>              | Start and stop modes; emergency stop mode and signal source selection; DC magnetization settings; autophasing mode selection.               | <a href="#">203</a> |
| <a href="#">22 Speed reference selection</a>    | Speed reference selection; motor potentiometer settings.  | <a href="#">210</a> |
| <a href="#">23 Speed reference ramp</a>         | Speed reference ramp settings (programming of the acceleration and deceleration rates for the drive).                                       | <a href="#">218</a> |
| <a href="#">24 Speed reference conditioning</a> | Speed error calculation; speed error window control configuration; speed error step.  | <a href="#">224</a> |
| <a href="#">25 Speed control</a>                | Speed controller settings.  | <a href="#">229</a> |
| <a href="#">26 Torque reference chain</a>       | Settings for the torque reference chain.  | <a href="#">240</a> |
| <a href="#">28 Frequency reference chain</a>    | Settings for the frequency reference chain.   | <a href="#">246</a> |
| <a href="#">30 Limits</a>                       | Drive operation limits.   | <a href="#">255</a> |
| <a href="#">31 Fault functions</a>              | Configuration of external events; selection of behavior of the drive upon fault situations.   | <a href="#">263</a> |
| <a href="#">32 Supervision</a>                  | Configuration of signal supervision functions 1...3.  | <a href="#">273</a> |
| <a href="#">33 Generic timer &amp; counter</a>  | Configuration of maintenance timers/counters.   | <a href="#">276</a> |
| <a href="#">35 Motor thermal protection</a>     | Motor thermal protection settings such as temperature measurement configuration, load curve definition and motor fan control configuration. | <a href="#">284</a> |
| <a href="#">36 Load analyzer</a>                | Peak value and amplitude logger settings.   | <a href="#">294</a> |
| <a href="#">37 User load curve</a>              | Settings for user load curve.   | <a href="#">298</a> |
| <a href="#">40 Process PID set 1</a>            | Parameter values for process PID control.   | <a href="#">301</a> |
| <a href="#">41 Process PID set 2</a>            | A second set of parameter values for process PID control.   | <a href="#">313</a> |
| <a href="#">43 Brake chopper</a>                | Settings for the internal brake chopper.  | <a href="#">315</a> |

## 114 Parameters

| <b>Group</b>                                   | <b>Contents</b>  | <b>Page</b>         |
|--|--|---------------------|
| <a href="#">44 Mechanical brake control</a>    | Configuration of mechanical brake control.   | <a href="#">317</a> |
| <a href="#">45 Energy efficiency</a>           | Settings for the energy saving calculators.  | <a href="#">321</a> |
| <a href="#">46 Monitoring/scaling settings</a> | Speed supervision settings; actual signal filtering; general scaling settings.   | <a href="#">324</a> |
| <a href="#">47 Data storage</a>                | Data storage parameters that can be written to and read from using other parameters' source and target settings.   | <a href="#">328</a> |
| <a href="#">49 Panel port communication</a>    | Communication settings for the control panel port on the drive.  | <a href="#">331</a> |
| <a href="#">50 Fieldbus adapter (FBA)</a>      | Fieldbus communication configuration.  | <a href="#">333</a> |
| <a href="#">51 FBA A settings</a>              | Fieldbus adapter A configuration.  | <a href="#">341</a> |
| <a href="#">52 FBA A data in</a>               | Selection of data to be transferred from drive to fieldbus controller through fieldbus adapter A.  | <a href="#">342</a> |
| <a href="#">53 FBA A data out</a>              | Selection of data to be transferred from fieldbus controller to drive through fieldbus adapter A.  | <a href="#">343</a> |
| <a href="#">54 FBA B settings</a>              | Fieldbus adapter B configuration.  | <a href="#">343</a> |
| <a href="#">55 FBA B data in</a>               | Selection of data to be transferred from drive to fieldbus controller through fieldbus adapter B.  | <a href="#">344</a> |
| <a href="#">56 FBA B data out</a>              | Selection of data to be transferred from fieldbus controller to drive through fieldbus adapter B.  | <a href="#">345</a> |
| <a href="#">58 Embedded fieldbus</a>           | Configuration of the embedded fieldbus (EFB) interface.  | <a href="#">345</a> |
| <a href="#">60 DDCS communication</a>          | DDCS communication configuration.  | <a href="#">353</a> |
| <a href="#">61 D2D and DDCS transmit data</a>  | Defines the data sent to the DDCS link.  | <a href="#">366</a> |
| <a href="#">62 D2D and DDCS receive data</a>   | Mapping of data received through the DDCS link.  | <a href="#">370</a> |
| <a href="#">90 Feedback selection</a>          | Motor and load feedback configuration.   | <a href="#">378</a> |
| <a href="#">91 Encoder module settings</a>     | Configuration of encoder interface modules.  | <a href="#">387</a> |
| <a href="#">92 Encoder 1 configuration</a>     | Settings for encoder 1.  | <a href="#">390</a> |
| <a href="#">93 Encoder 2 configuration</a>     | Settings for encoder 2.  | <a href="#">396</a> |
| <a href="#">94 LSU control</a>                 | Control of the supply unit of the drive, such as DC voltage and reactive power reference.  | <a href="#">396</a> |
| <a href="#">95 HW configuration</a>            | Various hardware-related settings.   | <a href="#">400</a> |
| <a href="#">96 System</a>                      | Language selection; access levels; macro selection; parameter save and restore; control unit reboot; user parameter sets; unit selection; data logger triggering; parameter checksum calculation; user lock. | <a href="#">405</a> |
| <a href="#">97 Motor control</a>               | Motor model settings.  | <a href="#">417</a> |
| <a href="#">98 User motor parameters</a>       | Motor values supplied by the user that are used in the motor model.  | <a href="#">421</a> |
| <a href="#">99 Motor data</a>                  | Motor configuration settings.  | <a href="#">423</a> |
| <a href="#">200 Safety</a>                     | FSO-xx settings.   | <a href="#">429</a> |

## Parameter listing

| No.                     | Name/Value                          | Description   | Def/FbEq16                        |
|-------------------------|-------------------------------------|---|-----------------------------------|
| <b>01 Actual values</b> |                                     | Basic signals for monitoring the drive.<br>All parameters in this group are read-only unless otherwise noted.   |                                   |
| 01.01                   | <i>Motor speed used</i>             | Measured or estimated motor speed depending on which type of feedback is used (see parameter <a href="#">90.41 Motor feedback selection</a> ). A filter time constant for this signal can be defined by parameter <a href="#">46.11 Filter time motor speed</a> . | -                                 |
|                         | -30000.00 ...<br>30000.00 rpm       | Measured or estimated motor speed.  | See par.<br><a href="#">46.01</a> |
| 01.02                   | <i>Motor speed estimated</i>        | Estimated motor speed in rpm. A filter time constant for this signal can be defined by parameter <a href="#">46.11 Filter time motor speed</a> .  | -                                 |
|                         | -30000.00 ...<br>30000.00 rpm       | Estimated motor speed.  | See par.<br><a href="#">46.01</a> |
| 01.03                   | <i>Motor speed %</i>                | Shows the value of <a href="#">01.01 Motor speed used</a> in percent of the synchronous speed of the motor.   | 10 = 1%                           |
|                         | -1000.00 ...<br>1000.00%            | Measured or estimated motor speed.  | See par.<br><a href="#">46.01</a> |
| 01.04                   | <i>Encoder 1 speed filtered</i>     | Speed of encoder 1 in rpm. A filter time constant for this signal can be defined by parameter <a href="#">46.11 Filter time motor speed</a> .   | -                                 |
|                         | -30000.00 ...<br>30000.00 rpm       | Encoder 1 speed.  | See par.<br><a href="#">46.01</a> |
| 01.05                   | <i>Encoder 2 speed filtered</i>     | Speed of encoder 2 in rpm. A filter time constant for this signal can be defined by parameter <a href="#">46.11 Filter time motor speed</a> .   | -                                 |
|                         | -30000.00 ...<br>30000.00 rpm       | Encoder 2 speed.  | See par.<br><a href="#">46.01</a> |
| 01.06                   | <i>Output frequency</i>             | Estimated drive output frequency in Hz. A filter time constant for this signal can be defined by parameter <a href="#">46.12 Filter time output frequency</a> .   | -                                 |
|                         | -500.00 ... 500.00<br>Hz            | Estimated output frequency.   | See par.<br><a href="#">46.02</a> |
| 01.07                   | <i>Motor current</i>                | Measured (absolute) motor current in A.   | -                                 |
|                         | 0.00 ... 30000.00 A                 | Motor current.  | See par.<br><a href="#">46.05</a> |
| 01.08                   | <i>Motor current % of motor nom</i> | Motor current (drive output current) in percent of the nominal motor current.   | -                                 |
|                         | 0.0 ... 1000.0%                     | Motor current.  | 1 = 1%                            |
| 01.10                   | <i>Motor torque</i>                 | Motor torque in percent of the nominal motor torque. See also parameter <a href="#">01.30 Nominal torque scale</a> .<br>A filter time constant for this signal can be defined by parameter <a href="#">46.13 Filter time motor torque</a> .                       | -                                 |
|                         | -1600.0 ... 1600.0%                 | Motor torque.   | See par.<br><a href="#">46.03</a> |
| 01.11                   | <i>DC voltage</i>                   | Measured DC link voltage.   | -                                 |
|                         | 0.00 ... 2000.00 V                  | DC link voltage.  | 10 = 1 V                          |
| 01.13                   | <i>Output voltage</i>               | Calculated motor voltage in V AC.   | -                                 |
|                         | 0...2000 V                          | Motor voltage.  | 1 = 1 V                           |

## 116 Parameters

| No.   | Name/Value                         | Description  | Def/FbEq16                     |
|-------|------------------------------------|--|--------------------------------|
| 01.14 | <i>Output power</i>                | Drive output power. The unit is selected by parameter <a href="#">96.16 Unit selection</a> . A filter time constant for this signal can be defined by parameter <a href="#">46.14 Filter time power out</a> .  | -                              |
|       | -32768.00 ...<br>32767.00 kW or hp | Output power.  | 1 = 1 unit                     |
| 01.15 | <i>Output power % of motor nom</i> | Shows the value of <a href="#">01.14 Output power</a> in percent of the nominal power of the motor.  | -                              |
|       | -300.00 ... 300.00%                | Output power.  | 10 = 1%                        |
| 01.17 | <i>Motor shaft power</i>           | Estimated mechanical power at motor shaft. The unit is selected by parameter <a href="#">96.16 Unit selection</a> . A filter time constant for this signal can be defined by parameter <a href="#">46.14 Filter time power out</a> .   | -                              |
|       | -32768.00 ...<br>32767.00 kW or hp | Motor shaft power.   | 1 = 1 unit                     |
| 01.18 | <i>Inverter GWh motoring</i>       | Amount of energy that has passed through the drive (towards the motor) in full gigawatt-hours. The minimum value is zero.  | -                              |
|       | 0...32767 GWh                      | Motoring energy in GWh.  | 1 = 1 GWh                      |
| 01.19 | <i>Inverter MWh motoring</i>       | Amount of energy that has passed through the drive (towards the motor) in full megawatt-hours. Whenever the counter rolls over, <a href="#">01.18 Inverter GWh motoring</a> is incremented. The minimum value is zero.   | -                              |
|       | 0...999 MWh                        | Motoring energy in MWh.  | 1 = 1 MWh                      |
| 01.20 | <i>Inverter kWh motoring</i>       | Amount of energy that has passed through the drive (towards the motor) in full kilowatt-hours. Whenever the counter rolls over, <a href="#">01.19 Inverter MWh motoring</a> is incremented. The minimum value is zero.   | -                              |
|       | 0...999 kWh                        | Motoring energy in kWh.  | 10 = 1 kWh                     |
| 01.21 | <i>U-phase current</i>             | Measured U-phase current.  | -                              |
|       | -30000.00 ...<br>30000.00 A        | U-phase current.   | See par. <a href="#">46.05</a> |
| 01.22 | <i>V-phase current</i>             | Measured V-phase current.  | -                              |
|       | -30000.00 ...<br>30000.00 A        | V-phase current.   | See par. <a href="#">46.05</a> |
| 01.23 | <i>W-phase current</i>             | Measured W-phase current.  | -                              |
|       | -30000.00 ...<br>30000.00 A        | W-phase current.   | See par. <a href="#">46.05</a> |
| 01.24 | <i>Flux actual %</i>               | Used flux reference in percent of nominal flux of motor.   | -                              |
|       | 0...200%                           | Flux reference.  | 1 = 1%                         |
| 01.25 | <i>INU momentary cos phi</i>       | Momentary cosphi of the drive.   | -                              |
|       | -1.00 ... 1.00                     | Cosphi.  | 100 = 1                        |
| 01.29 | <i>Speed change rate</i>           | Rate of actual speed change. Positive values indicate acceleration, negative values indicate deceleration. See also parameters <a href="#">31.32 Emergency ramp supervision</a> , <a href="#">31.33 Emergency ramp supervision delay</a> , <a href="#">31.37 Ramp stop supervision</a> and <a href="#">31.38 Ramp stop supervision delay</a> . | -                              |
|       | -15000 ... 15000 rpm/s             | Rate of speed change.  | 1 = 1 rpm/s                    |

| No.   | Name/Value                       | Description   | Def/FbEq16                     |
|-------|----------------------------------|---|--------------------------------|
| 01.30 | <i>Nominal torque scale</i>      | Torque that corresponds to 100% of nominal motor torque. The unit is selected by parameter <a href="#">96.16 Unit selection</a><br><b>Note:</b> This value is copied from parameter <a href="#">99.12 Motor nominal torque</a> if entered. Otherwise the value is calculated from other motor data. | -                              |
|       | 0.000... N·m or lb·ft            | Nominal torque.   | 1 = 1 unit                     |
| 01.31 | <i>Ambient temperature</i>       | Measured temperature of incoming cooling air. The unit is selected by parameter <a href="#">96.16 Unit selection</a> .  | -                              |
|       | -40 ... 120 °C or °F             | Cooling air temperature.  | 1 = 1°                         |
| 01.32 | <i>Inverter GWh regenerating</i> | Amount of energy that has passed through the drive (towards the supply) in full gigawatt-hours. The minimum value is zero.  | -                              |
|       | 0...32767 GWh                    | Regenerative energy in GWh.   | 1 = 1 GWh                      |
| 01.33 | <i>Inverter MWh regenerating</i> | Amount of energy that has passed through the drive (towards the supply) in full megawatt-hours. Whenever the counter rolls over, <a href="#">01.32 Inverter GWh regenerating</a> is incremented. The minimum value is zero.   | -                              |
|       | 0...999 MWh                      | Regenerative energy in MWh.   | 1 = 1 MWh                      |
| 01.34 | <i>Inverter kWh regenerating</i> | Amount of energy that has passed through the drive (towards the supply) in full kilowatt-hours. Whenever the counter rolls over, <a href="#">01.33 Inverter MWh regenerating</a> is incremented. The minimum value is zero.   | -                              |
|       | 0...999 kWh                      | Regenerative energy in kWh.   | 10 = 1 kWh                     |
| 01.35 | <i>Mot - regen energy GWh</i>    | Amount of net energy (motoring energy - regenerating energy) that has passed through the drive in full gigawatt-hours.  | -                              |
|       | -32768...32767 GWh               | Energy balance in GWh.  | 1 = 1 GWh                      |
| 01.36 | <i>Mot - regen energy MWh</i>    | Amount of net energy (motoring energy - regenerating energy) that has passed through the drive in full megawatt-hours. Whenever the counter rolls over, <a href="#">01.35 Mot - regen energy GWh</a> is incremented or decremented.   | -                              |
|       | -999...999 MWh                   | Energy balance in MWh.  | 1 = 1 MWh                      |
| 01.37 | <i>Mot - regen energy kWh</i>    | Amount of energy (motoring energy - regenerating energy) that has passed through the drive in full kilowatt-hours. Whenever the counter rolls over, <a href="#">01.36 Mot - regen energy MWh</a> is incremented or decremented.   | -                              |
|       | -999...999 kWh                   | Energy balance in kWh.  | 10 = 1 kWh                     |
| 01.61 | <i>Abs motor speed used</i>      | Absolute value of <a href="#">01.01 Motor speed used</a> .  | -                              |
|       | 0.00 ... 30000.00 rpm            | Measured or estimated motor speed.  | See par. <a href="#">46.01</a> |
| 01.62 | <i>Abs motor speed %</i>         | Absolute value of <a href="#">01.03 Motor speed %</a> .   | -                              |
|       | 0.00 ... 1000.00%                | Measured or estimated motor speed.  | 10 = 1%                        |
| 01.63 | <i>Abs output frequency</i>      | Absolute value of <a href="#">01.06 Output frequency</a> .  | -                              |
|       | 0.00 ... 500.00 Hz               | Estimated output frequency.   | See par. <a href="#">46.02</a> |
| 01.64 | <i>Abs motor torque</i>          | Absolute value of <a href="#">01.10 Motor torque</a> .  | -                              |
|       | 0.0 ... 1600.0%                  | Motor torque.   | See par. <a href="#">46.03</a> |

## 118 Parameters

| No.                    | Name/Value                                   | Description  | Def/FbEq16                     |
|------------------------|--|--|--------------------------------|
| <a href="#">01.65</a>  | <a href="#">Abs output power</a>             | Absolute value of <a href="#">01.14 Output power</a> .   | -                              |
|                        | 0.00 ... 32767.00<br>kW or hp                | Output power.  | 1 = 1 unit                     |
| <a href="#">01.66</a>  | <a href="#">Abs output power % motor nom</a> | Absolute value of <a href="#">01.15 Output power % of motor nom</a> .  | -                              |
|                        | 0.00 ... 300.00%                             | Output power.  | 10 = 1%                        |
| <a href="#">01.68</a>  | <a href="#">Abs motor shaft power</a>        | Absolute value of <a href="#">01.17 Motor shaft power</a> .  | -                              |
|                        | 0.00 ... 32767.00<br>kW or hp                | Motor shaft power.   | 1 = 1 unit                     |
| <a href="#">01.70</a>  | <a href="#">Ambient temperature %</a>        | Measured temperature of incoming cooling air.<br>The amplitude range of 0...100% corresponds to 0...60 °C or 32...140 °F.<br>See also <a href="#">01.31 Ambient temperature</a> .  | -                              |
|                        | -200.00 ... 200.00%                          | Cooling air temperature.   | 1 = 1%                         |
| <a href="#">01.71</a>  | <a href="#">Step-up motor current</a>        | Estimated motor current in A when a step-up transformer is in use. The value is calculated from parameter <a href="#">01.07</a> using the step-up transformer ratio ( <a href="#">95.40</a> ) and sine filter values <a href="#">99.18</a> and <a href="#">99.19</a> . | -                              |
|                        | 0.00 ... 30000.00 A                          | Estimated motor current.   | See par. <a href="#">46.05</a> |
| <a href="#">01.72</a>  | <a href="#">U-phase RMS current</a>          | U-phase rms current.   | -                              |
|                        | 0.00 ... 30000.00 A                          | U-phase rms current.   | See par. <a href="#">46.05</a> |
| <a href="#">01.73</a>  | <a href="#">V-phase RMS current</a>          | V-phase rms current.   | -                              |
|                        | 0.00 ... 30000.00 A                          | V-phase rms current.   | See par. <a href="#">46.05</a> |
| <a href="#">01.74</a>  | <a href="#">W-phase RMS current</a>          | W-phase rms current.   | -                              |
|                        | 0.00 ... 30000.00 A                          | W-phase rms current.   | See par. <a href="#">46.05</a> |
| <a href="#">01.102</a> | <a href="#">Line current</a>                 | <i>(Only visible when IGBT supply unit control activated by <a href="#">95.20</a>)</i><br>Estimated line current flowing through the supply unit.  | -                              |
|                        | 0.00 ... 30000.00 A                          | Estimated line current.  | See par. <a href="#">46.05</a> |
| <a href="#">01.104</a> | <a href="#">Active current</a>               | <i>(Only visible when IGBT supply unit control activated by <a href="#">95.20</a>)</i><br>Estimated active current flowing through the supply unit.  | -                              |
|                        | 0.00 ... 30000.00 A                          | Estimated active current.  | See par. <a href="#">46.05</a> |
| <a href="#">01.106</a> | <a href="#">Reactive current</a>             | <i>(Only visible when IGBT supply unit control activated by <a href="#">95.20</a>)</i><br>Estimated reactive current flowing through the supply unit.  | -                              |
|                        | 0.00 ... 30000.00 A                          | Estimated reactive current.  | See par. <a href="#">46.05</a> |

| No.                        | Name/Value                  | Description  | Def/FbEq16     |
|----------------------------|-----------------------------|--|----------------|
| 01.108                     | <i>Grid frequency</i>       | (Only visible when IGBT supply unit control activated by 95.20)<br>Estimated frequency of the power supply network.                    | -              |
|                            | 0.00 ... 100.00 Hz          | Estimated supply frequency.  | See par. 46.02 |
| 01.109                     | <i>Grid voltage</i>         | (Only visible when IGBT supply unit control activated by 95.20)<br>Estimated voltage of the power supply network.                      | -              |
|                            | 0.00 ... 2000.00 V          | Estimated supply voltage.  | 10 = 1 V       |
| 01.110                     | <i>Grid apparent power</i>  | (Only visible when IGBT supply unit control activated by 95.20)<br>Estimated apparent power being transferred through the supply unit. | -              |
|                            | -30000.00 ... 30000.00 kVA  | Estimated apparent power.  | See par. 46.04 |
| 01.112                     | <i>Grid power</i>           | (Only visible when IGBT supply unit control activated by 95.20)<br>Estimated power being transferred through the supply unit.          | -              |
|                            | -30000.00 ... 30000.00 kW   | Estimated supply power.  | See par. 46.04 |
| 01.114                     | <i>Grid reactive power</i>  | (Only visible when IGBT supply unit control activated by 95.20)<br>Estimated reactive power being transferred through the supply unit. | -              |
|                            | -30000.00 ... 30000.00 kvar | Estimated reactive power.  | 10 = 1 kvar    |
| 01.116                     | <i>LSU cos ?</i>            | (Only visible when IGBT supply unit control activated by 95.20)<br>Power factor of the supply unit.                                    | -              |
|                            | -1.00 ... 1.00              | Power factor.  | 100 = 1        |
| 01.164                     | <i>LSU nominal power</i>    | (Only visible when IGBT supply unit control activated by 95.20)<br>Nominal power of the supply unit.                                   | -              |
|                            | 0...30000 kW                | Nominal power.   | 1 = 1 kW       |
| <b>03 Input references</b> |                             | Values of references received from various sources.<br>All parameters in this group are read-only unless otherwise noted.              |                |
| 03.01                      | <i>Panel reference</i>      | Local reference given from the control panel or PC tool.   | -              |
|                            | -100000.00 ... 100000.00    | Local control panel or PC tool reference.  | 1 = 10         |
| 03.02                      | <i>Panel reference 2</i>    | Remote reference given from the control panel or PC tool.  | -              |
|                            | -30000.00 ... 30000.00      | Remote control panel or PC tool reference.   | 1 = 10         |
| 03.05                      | <i>FB A reference 1</i>     | Reference 1 received through fieldbus adapter A.<br>See also chapter <i>Fieldbus control through a fieldbus adapter</i> (page 551).    | -              |
|                            | -100000.00 ... 100000.00    | Reference 1 from fieldbus adapter A.   | 1 = 10         |



## 120 Parameters

| No.                           | Name/Value                   | Description  | Def/FbEq16 |
|-------------------------------|------------------------------|--|------------|
| 03.06                         | <i>FB A reference 2</i>      | Reference 2 received through fieldbus adapter A.   | -          |
|                               | -100000.00 ...<br>100000.00  | Reference 2 from fieldbus adapter A.   | 1 = 10     |
| 03.07                         | <i>FB B reference 1</i>      | Reference 1 received through fieldbus adapter B.   | -          |
|                               | -100000.00 ...<br>100000.00  | Reference 1 from fieldbus adapter B.   | 1 = 10     |
| 03.08                         | <i>FB B reference 2</i>      | Reference 2 received through fieldbus adapter B.   | -          |
|                               | -100000.00 ...<br>100000.00  | Reference 2 from fieldbus adapter B.   | 1 = 10     |
| 03.09                         | <i>EFB reference 1</i>       | Scaled reference 1 received through the embedded fieldbus interface. The scaling is defined by <a href="#">58.26 EFB ref1 type</a> .   | 1 = 10     |
|                               | -30000.00 ...<br>30000.00    | Reference 1 received through the embedded fieldbus interface.  | 1 = 10     |
| 03.10                         | <i>EFB reference 2</i>       | Scaled reference 2 received through the embedded fieldbus interface. The scaling is defined by <a href="#">58.27 EFB ref2 type</a> .   | 1 = 10     |
|                               | -30000.00 ...<br>30000.00    | Reference 2 received through the embedded fieldbus interface.  | 1 = 10     |
| 03.11                         | <i>DDCS controller ref 1</i> | Reference 1 received from the external (DDCS) controller. The value has been scaled according to parameter <a href="#">60.60 DDCS controller ref1 type</a> . See also section <a href="#">External controller interface</a> (page 38). | 1 = 10     |
|                               | -30000.00 ...<br>30000.00    | Scaled reference 1 received from external controller.  | 1 = 10     |
| 03.12                         | <i>DDCS controller ref 2</i> | Reference 2 received from the external (DDCS) controller. The value has been scaled according to parameter <a href="#">60.61 DDCS controller ref2 type</a> .   | 1 = 10     |
|                               | -30000.00 ...<br>30000.00    | Scaled reference 2 received from external controller.  | 1 = 10     |
| 03.13                         | <i>M/F or D2D ref1</i>       | Master/follower reference 1 received from the master. The value has been scaled according to parameter <a href="#">60.10 M/F ref1 type</a> . See also section <a href="#">Master/follower functionality</a> (page 31).                 | 1 = 10     |
|                               | -30000.00 ...<br>30000.00    | Scaled reference 1 received from master.   | 1 = 10     |
| 03.14                         | <i>M/F or D2D ref2</i>       | Master/follower reference 2 received from the master. The value has been scaled according to parameter <a href="#">60.11 M/F ref2 type</a> .   | 1 = 10     |
|                               | -30000.00 ...<br>30000.00    | Scaled reference 2 received from master.   | 1 = 10     |
| <b>04 Warnings and faults</b> |                              | Information on warnings and faults that occurred last. For explanations of individual warning and fault codes, see chapter <a href="#">Fault tracing</a> . All parameters in this group are read-only unless otherwise noted.          |            |
| 04.01                         | <i>Tripping fault</i>        | Code of the 1st active fault (the fault that caused the current trip).   | -          |
|                               | 0000h...FFFFh                | 1st active fault.  | 1 = 1      |
| 04.02                         | <i>Active fault 2</i>        | Code of the 2nd active fault.  | -          |
|                               | 0000h...FFFFh                | 2nd active fault.  | 1 = 1      |



| No.   | Name/Value                | Description                                  | Def/FbEq16 |
|-------|---------------------------|--|------------|
| 04.03 | <i>Active fault 3</i>     | Code of the 3rd active fault.                | -          |
|       | 0000h...FFFFh             | 3rd active fault.                            | 1 = 1      |
| 04.04 | <i>Active fault 4</i>     | Code of the 4th active fault.                | -          |
|       | 0000h...FFFFh             | 4th active fault.                            | 1 = 1      |
| 04.05 | <i>Active fault 5</i>     | Code of the 5th active fault.                | -          |
|       | 0000h...FFFFh             | 5th active fault.                            | 1 = 1      |
| 04.06 | <i>Active warning 1</i>   | Code of the 1st active warning.              | -          |
|       | 0000h...FFFFh             | 1st active warning.                          | 1 = 1      |
| 04.07 | <i>Active warning 2</i>   | Code of the 2nd active warning.              | -          |
|       | 0000h...FFFFh             | 2nd active warning.                          | 1 = 1      |
| 04.08 | <i>Active warning 3</i>   | Code of the 3rd active warning.              | -          |
|       | 0000h...FFFFh             | 3rd active warning.                          | 1 = 1      |
| 04.09 | <i>Active warning 4</i>   | Code of the 4th active warning.              | -          |
|       | 0000h...FFFFh             | 4th active warning.                          | 1 = 1      |
| 04.10 | <i>Active warning 5</i>   | Code of the 5th active warning.              | -          |
|       | 0000h...FFFFh             | 5th active warning.                          | 1 = 1      |
| 04.11 | <i>Latest fault</i>       | Code of the 1st stored (non-active) fault.   | -          |
|       | 0000h...FFFFh             | 1st stored fault.                            | 1 = 1      |
| 04.12 | <i>2nd latest fault</i>   | Code of the 2nd stored (non-active) fault.   | -          |
|       | 0000h...FFFFh             | 2nd stored fault.                            | 1 = 1      |
| 04.13 | <i>3rd latest fault</i>   | Code of the 3rd stored (non-active) fault.   | -          |
|       | 0000h...FFFFh             | 3rd stored fault.                            | 1 = 1      |
| 04.14 | <i>4th latest fault</i>   | Code of the 4th stored (non-active) fault.   | -          |
|       | 0000h...FFFFh             | 4th stored fault.                            | 1 = 1      |
| 04.15 | <i>5th latest fault</i>   | Code of the 5th stored (non-active) fault.   | -          |
|       | 0000h...FFFFh             | 5th stored fault.                            | 1 = 1      |
| 04.16 | <i>Latest warning</i>     | Code of the 1st stored (non-active) warning. | -          |
|       | 0000h...FFFFh             | 1st stored warning.                          | 1 = 1      |
| 04.17 | <i>2nd latest warning</i> | Code of the 2nd stored (non-active) warning. | -          |
|       | 0000h...FFFFh             | 2nd stored warning.                          | 1 = 1      |
| 04.18 | <i>3rd latest warning</i> | Code of the 3rd stored (non-active) warning. | -          |
|       | 0000h...FFFFh             | 3rd stored warning.                          | 1 = 1      |
| 04.19 | <i>4th latest warning</i> | Code of the 4th stored (non-active) warning. | -          |
|       | 0000h...FFFFh             | 4th stored warning.                          | 1 = 1      |
| 04.20 | <i>5th latest warning</i> | Code of the 5th stored (non-active) warning. | -          |
|       | 0000h...FFFFh             | 5th stored warning.                          | 1 = 1      |

| No.   | Name/Value                              | Description   | Def/FbEq16   |     |                   |  |  |   |                                       |   |            |            |      |   |             |             |      |   |             |             |      |   |             |             |                                    |   |             |             |                  |   |            |              |      |   |            |            |      |   |              |              |  |   |           |           |   |   |          |          |      |    |          |              |      |    |          |               |      |    |          |           |                  |    |          |           |                  |    |          |           |                  |    |          |           |                  |
|---|---|---|--|-----|-------------------|--|--|---|---------------------------------------|---|------------|------------|------|---|-------------|-------------|------|---|-------------|-------------|------|---|-------------|-------------|------------------------------------|---|-------------|-------------|------------------|---|------------|--------------|------|---|------------|------------|------|---|--------------|--------------|--|---|-----------|-----------|---|---|----------|----------|------|----|----------|--------------|------|----|----------|---------------|------|----|----------|-----------|------------------|----|----------|-----------|------------------|----|----------|-----------|------------------|----|----------|-----------|------------------|
| 04.21   | <i>Fault word 1</i>                     | <p>ACS800-compatible fault word 1.</p> <p>The bit assignments of this word correspond to FAULT WORD 1 in the ACS800. Parameter <i>04.120 Fault/Warning word compatibility</i> determines whether the bit assignments are according to the ACS800 Standard or ACS800 System control program.</p> <p>Each bit can indicate several ACS880 events as listed below.</p> <p>This parameter is read-only.</p> | -  |     |                   |  |  |   |                                       |   |            |            |      |   |             |             |      |   |             |             |      |   |             |             |                                    |   |             |             |                  |   |            |              |      |   |            |            |      |   |              |              |  |   |           |           |   |   |          |          |      |    |          |              |      |    |          |               |      |    |          |           |                  |    |          |           |                  |    |          |           |                  |    |          |           |                  |
| <table border="1"> <thead> <tr> <th rowspan="2">Bit</th> <th colspan="2">ACS800 fault name</th> <th rowspan="2">ACS880 events indicated by this bit<br/>(see <i>Fault tracing</i>, page 487)</th> </tr> <tr> <th>(04.120 = ACS800 Standard ctrl program)</th> <th>(04.120 = ACS800 System ctrl program)</th> </tr> </thead> <tbody> <tr> <td>0</td> <td>SHORT CIRC</td> <td>SHORT CIRC</td> <td>2340</td> </tr> <tr> <td>1</td> <td>OVERCURRENT</td> <td>OVERCURRENT</td> <td>2310</td> </tr> <tr> <td>2</td> <td>DC OVERVOLT</td> <td>DC OVERVOLT</td> <td>3210</td> </tr> <tr> <td>3</td> <td>ACS800 TEMP</td> <td>ACS800 TEMP</td> <td>2381, 4210, 4290, 42F1, 4310, 4380</td> </tr> <tr> <td>4</td> <td>EARTH FAULT</td> <td>EARTH FAULT</td> <td>2330, 2392, 3181</td> </tr> <tr> <td>5</td> <td>THERMISTOR</td> <td>MOTOR TEMP M</td> <td>4981</td> </tr> <tr> <td>6</td> <td>MOTOR TEMP</td> <td>MOTOR TEMP</td> <td>4982</td> </tr> <tr> <td>7</td> <td>SYSTEM_FAULT</td> <td>SYSTEM_FAULT</td> <td>6481, 6487, 64A1, 64A2, 64A3, 64B1, 64E1, 6881, 6882, 6883, 6885</td> </tr> <tr> <td>8</td> <td>UNDERLOAD</td> <td>UNDERLOAD</td> <td>-</td> </tr> <tr> <td>9</td> <td>OVERFREQ</td> <td>OVERFREQ</td> <td>7310</td> </tr> <tr> <td>10</td> <td>Reserved</td> <td>MPROT SWITCH</td> <td>9081</td> </tr> <tr> <td>11</td> <td>Reserved</td> <td>CH2 COMM LOSS</td> <td>7582</td> </tr> <tr> <td>12</td> <td>Reserved</td> <td>SC (INU1)</td> <td>2340 (XXYY YY01)</td> </tr> <tr> <td>13</td> <td>Reserved</td> <td>SC (INU2)</td> <td>2340 (XXYY YY02)</td> </tr> <tr> <td>14</td> <td>Reserved</td> <td>SC (INU3)</td> <td>2340 (XXYY YY03)</td> </tr> <tr> <td>15</td> <td>Reserved</td> <td>SC (INU4)</td> <td>2340 (XXYY YY04)</td> </tr> </tbody> </table> |   |   |  | Bit | ACS800 fault name |  | ACS880 events indicated by this bit<br>(see <i>Fault tracing</i> , page 487) | (04.120 = ACS800 Standard ctrl program) | (04.120 = ACS800 System ctrl program) | 0 | SHORT CIRC | SHORT CIRC | 2340 | 1 | OVERCURRENT | OVERCURRENT | 2310 | 2 | DC OVERVOLT | DC OVERVOLT | 3210 | 3 | ACS800 TEMP | ACS800 TEMP | 2381, 4210, 4290, 42F1, 4310, 4380 | 4 | EARTH FAULT | EARTH FAULT | 2330, 2392, 3181 | 5 | THERMISTOR | MOTOR TEMP M | 4981 | 6 | MOTOR TEMP | MOTOR TEMP | 4982 | 7 | SYSTEM_FAULT | SYSTEM_FAULT | 6481, 6487, 64A1, 64A2, 64A3, 64B1, 64E1, 6881, 6882, 6883, 6885 | 8 | UNDERLOAD | UNDERLOAD | - | 9 | OVERFREQ | OVERFREQ | 7310 | 10 | Reserved | MPROT SWITCH | 9081 | 11 | Reserved | CH2 COMM LOSS | 7582 | 12 | Reserved | SC (INU1) | 2340 (XXYY YY01) | 13 | Reserved | SC (INU2) | 2340 (XXYY YY02) | 14 | Reserved | SC (INU3) | 2340 (XXYY YY03) | 15 | Reserved | SC (INU4) | 2340 (XXYY YY04) |
| Bit   | ACS800 fault name                       |   | ACS880 events indicated by this bit<br>(see <i>Fault tracing</i> , page 487) |     |                   |  |  |   |                                       |   |            |            |      |   |             |             |      |   |             |             |      |   |             |             |                                    |   |             |             |                  |   |            |              |      |   |            |            |      |   |              |              |  |   |           |           |   |   |          |          |      |    |          |              |      |    |          |               |      |    |          |           |                  |    |          |           |                  |    |          |           |                  |    |          |           |                  |
|   | (04.120 = ACS800 Standard ctrl program) | (04.120 = ACS800 System ctrl program)   |  |     |                   |  |  |   |                                       |   |            |            |      |   |             |             |      |   |             |             |      |   |             |             |                                    |   |             |             |                  |   |            |              |      |   |            |            |      |   |              |              |  |   |           |           |   |   |          |          |      |    |          |              |      |    |          |               |      |    |          |           |                  |    |          |           |                  |    |          |           |                  |    |          |           |                  |
| 0   | SHORT CIRC                              | SHORT CIRC  | 2340   |     |                   |  |  |   |                                       |   |            |            |      |   |             |             |      |   |             |             |      |   |             |             |                                    |   |             |             |                  |   |            |              |      |   |            |            |      |   |              |              |  |   |           |           |   |   |          |          |      |    |          |              |      |    |          |               |      |    |          |           |                  |    |          |           |                  |    |          |           |                  |    |          |           |                  |
| 1   | OVERCURRENT                             | OVERCURRENT   | 2310   |     |                   |  |  |   |                                       |   |            |            |      |   |             |             |      |   |             |             |      |   |             |             |                                    |   |             |             |                  |   |            |              |      |   |            |            |      |   |              |              |  |   |           |           |   |   |          |          |      |    |          |              |      |    |          |               |      |    |          |           |                  |    |          |           |                  |    |          |           |                  |    |          |           |                  |
| 2   | DC OVERVOLT                             | DC OVERVOLT   | 3210   |     |                   |  |  |   |                                       |   |            |            |      |   |             |             |      |   |             |             |      |   |             |             |                                    |   |             |             |                  |   |            |              |      |   |            |            |      |   |              |              |  |   |           |           |   |   |          |          |      |    |          |              |      |    |          |               |      |    |          |           |                  |    |          |           |                  |    |          |           |                  |    |          |           |                  |
| 3   | ACS800 TEMP                             | ACS800 TEMP   | 2381, 4210, 4290, 42F1, 4310, 4380   |     |                   |  |  |   |                                       |   |            |            |      |   |             |             |      |   |             |             |      |   |             |             |                                    |   |             |             |                  |   |            |              |      |   |            |            |      |   |              |              |  |   |           |           |   |   |          |          |      |    |          |              |      |    |          |               |      |    |          |           |                  |    |          |           |                  |    |          |           |                  |    |          |           |                  |
| 4   | EARTH FAULT                             | EARTH FAULT   | 2330, 2392, 3181   |     |                   |  |  |   |                                       |   |            |            |      |   |             |             |      |   |             |             |      |   |             |             |                                    |   |             |             |                  |   |            |              |      |   |            |            |      |   |              |              |  |   |           |           |   |   |          |          |      |    |          |              |      |    |          |               |      |    |          |           |                  |    |          |           |                  |    |          |           |                  |    |          |           |                  |
| 5   | THERMISTOR                              | MOTOR TEMP M  | 4981   |     |                   |  |  |   |                                       |   |            |            |      |   |             |             |      |   |             |             |      |   |             |             |                                    |   |             |             |                  |   |            |              |      |   |            |            |      |   |              |              |  |   |           |           |   |   |          |          |      |    |          |              |      |    |          |               |      |    |          |           |                  |    |          |           |                  |    |          |           |                  |    |          |           |                  |
| 6   | MOTOR TEMP                              | MOTOR TEMP  | 4982   |     |                   |  |  |   |                                       |   |            |            |      |   |             |             |      |   |             |             |      |   |             |             |                                    |   |             |             |                  |   |            |              |      |   |            |            |      |   |              |              |  |   |           |           |   |   |          |          |      |    |          |              |      |    |          |               |      |    |          |           |                  |    |          |           |                  |    |          |           |                  |    |          |           |                  |
| 7   | SYSTEM_FAULT                            | SYSTEM_FAULT  | 6481, 6487, 64A1, 64A2, 64A3, 64B1, 64E1, 6881, 6882, 6883, 6885             |     |                   |  |  |   |                                       |   |            |            |      |   |             |             |      |   |             |             |      |   |             |             |                                    |   |             |             |                  |   |            |              |      |   |            |            |      |   |              |              |  |   |           |           |   |   |          |          |      |    |          |              |      |    |          |               |      |    |          |           |                  |    |          |           |                  |    |          |           |                  |    |          |           |                  |
| 8   | UNDERLOAD                               | UNDERLOAD   | -  |     |                   |  |  |   |                                       |   |            |            |      |   |             |             |      |   |             |             |      |   |             |             |                                    |   |             |             |                  |   |            |              |      |   |            |            |      |   |              |              |  |   |           |           |   |   |          |          |      |    |          |              |      |    |          |               |      |    |          |           |                  |    |          |           |                  |    |          |           |                  |    |          |           |                  |
| 9   | OVERFREQ                                | OVERFREQ  | 7310   |     |                   |  |  |   |                                       |   |            |            |      |   |             |             |      |   |             |             |      |   |             |             |                                    |   |             |             |                  |   |            |              |      |   |            |            |      |   |              |              |  |   |           |           |   |   |          |          |      |    |          |              |      |    |          |               |      |    |          |           |                  |    |          |           |                  |    |          |           |                  |    |          |           |                  |
| 10  | Reserved                                | MPROT SWITCH  | 9081   |     |                   |  |  |   |                                       |   |            |            |      |   |             |             |      |   |             |             |      |   |             |             |                                    |   |             |             |                  |   |            |              |      |   |            |            |      |   |              |              |  |   |           |           |   |   |          |          |      |    |          |              |      |    |          |               |      |    |          |           |                  |    |          |           |                  |    |          |           |                  |    |          |           |                  |
| 11  | Reserved                                | CH2 COMM LOSS   | 7582   |     |                   |  |  |   |                                       |   |            |            |      |   |             |             |      |   |             |             |      |   |             |             |                                    |   |             |             |                  |   |            |              |      |   |            |            |      |   |              |              |  |   |           |           |   |   |          |          |      |    |          |              |      |    |          |               |      |    |          |           |                  |    |          |           |                  |    |          |           |                  |    |          |           |                  |
| 12  | Reserved                                | SC (INU1)   | 2340 (XXYY YY01)   |     |                   |  |  |   |                                       |   |            |            |      |   |             |             |      |   |             |             |      |   |             |             |                                    |   |             |             |                  |   |            |              |      |   |            |            |      |   |              |              |  |   |           |           |   |   |          |          |      |    |          |              |      |    |          |               |      |    |          |           |                  |    |          |           |                  |    |          |           |                  |    |          |           |                  |
| 13  | Reserved                                | SC (INU2)   | 2340 (XXYY YY02)   |     |                   |  |  |   |                                       |   |            |            |      |   |             |             |      |   |             |             |      |   |             |             |                                    |   |             |             |                  |   |            |              |      |   |            |            |      |   |              |              |  |   |           |           |   |   |          |          |      |    |          |              |      |    |          |               |      |    |          |           |                  |    |          |           |                  |    |          |           |                  |    |          |           |                  |
| 14  | Reserved                                | SC (INU3)   | 2340 (XXYY YY03)   |     |                   |  |  |   |                                       |   |            |            |      |   |             |             |      |   |             |             |      |   |             |             |                                    |   |             |             |                  |   |            |              |      |   |            |            |      |   |              |              |  |   |           |           |   |   |          |          |      |    |          |              |      |    |          |               |      |    |          |           |                  |    |          |           |                  |    |          |           |                  |    |          |           |                  |
| 15  | Reserved                                | SC (INU4)   | 2340 (XXYY YY04)   |     |                   |  |  |   |                                       |   |            |            |      |   |             |             |      |   |             |             |      |   |             |             |                                    |   |             |             |                  |   |            |              |      |   |            |            |      |   |              |              |  |   |           |           |   |   |          |          |      |    |          |              |      |    |          |               |      |    |          |           |                  |    |          |           |                  |    |          |           |                  |    |          |           |                  |
| 0000h...FFFFh   |   | ACS800-compatible fault word 1.   | 1 = 1  |     |                   |  |  |   |                                       |   |            |            |      |   |             |             |      |   |             |             |      |   |             |             |                                    |   |             |             |                  |   |            |              |      |   |            |            |      |   |              |              |  |   |           |           |   |   |          |          |      |    |          |              |      |    |          |               |      |    |          |           |                  |    |          |           |                  |    |          |           |                  |    |          |           |                  |

| No.   | Name/Value  | Description  | Def/FbEq16  |     |                   |  |   |   |   |   |              |              |                      |   |             |               |   |   |              |              |                      |   |          |            |                      |   |            |             |                      |   |             |             |  |   |          |             |                            |   |             |             |   |   |              |            |                      |   |             |             |   |    |               |             |                      |    |           |           |  |    |             |             |  |    |            |            |                      |    |             |             |                      |    |             |             |                      |
|---|---|--|---|-----|-------------------|--|---|---|---|---|--------------|--------------|----------------------|---|-------------|---------------|---|---|--------------|--------------|----------------------|---|----------|------------|----------------------|---|------------|-------------|----------------------|---|-------------|-------------|--|---|----------|-------------|----------------------------|---|-------------|-------------|---|---|--------------|------------|----------------------|---|-------------|-------------|---|----|---------------|-------------|----------------------|----|-----------|-----------|--|----|-------------|-------------|--|----|------------|------------|----------------------|----|-------------|-------------|----------------------|----|-------------|-------------|----------------------|
| 04.22   | <i>Fault word 2</i>                                       | <p>ACS800-compatible fault word 2.</p> <p>The bit assignments of this word correspond to FAULT WORD 2 in the ACS800. Parameter <a href="#">04.120 Fault/Warning word compatibility</a> determines whether the bit assignments are according to the ACS800 Standard or ACS800 System control program.</p> <p>Each bit can indicate several ACS880 events as listed below.</p> <p>This parameter is read-only.</p> | -   |     |                   |  |   |   |   |   |              |              |                      |   |             |               |   |   |              |              |                      |   |          |            |                      |   |            |             |                      |   |             |             |  |   |          |             |                            |   |             |             |   |   |              |            |                      |   |             |             |   |    |               |             |                      |    |           |           |  |    |             |             |  |    |            |            |                      |    |             |             |                      |    |             |             |                      |
| <table border="1"> <thead> <tr> <th rowspan="2">Bit</th> <th colspan="2">ACS800 fault name</th> <th rowspan="2">ACS880 events indicated by this bit<br/>(see <a href="#">Fault tracing</a>, page 487)</th> </tr> <tr> <th>(<a href="#">04.120 = ACS800 Standard ctrl program</a>)</th> <th>(<a href="#">04.120 = ACS800 System ctrl program</a>)</th> </tr> </thead> <tbody> <tr> <td>0</td> <td>SUPPLY PHASE</td> <td>SUPPLY PHASE</td> <td><a href="#">3130</a></td> </tr> <tr> <td>1</td> <td>NO MOT DATA</td> <td>NO MOTOR DATA</td> <td>-</td> </tr> <tr> <td>2</td> <td>DC UNDERVOLT</td> <td>DC UNDERVOLT</td> <td><a href="#">3220</a></td> </tr> <tr> <td>3</td> <td>Reserved</td> <td>CABLE TEMP</td> <td><a href="#">4000</a></td> </tr> <tr> <td>4</td> <td>RUN ENABLE</td> <td>RUN DISABLE</td> <td><a href="#">AFEB</a></td> </tr> <tr> <td>5</td> <td>ENCODER ERR</td> <td>ENCODER ERR</td> <td><a href="#">7301, 7380, 7381, 73A0, 73A1</a></td> </tr> <tr> <td>6</td> <td>I/O COMM</td> <td>IO COMM ERR</td> <td><a href="#">7080, 7082</a></td> </tr> <tr> <td>7</td> <td>CTRL B TEMP</td> <td>CTRL B TEMP</td> <td>-</td> </tr> <tr> <td>8</td> <td>EXTERNAL FLT</td> <td>SELECTABLE</td> <td><a href="#">9082</a></td> </tr> <tr> <td>9</td> <td>OVER SWFREQ</td> <td>OVER SWFREQ</td> <td>-</td> </tr> <tr> <td>10</td> <td>AI &lt; MIN FUNC</td> <td>AI&lt;MIN FUNC</td> <td><a href="#">80A0</a></td> </tr> <tr> <td>11</td> <td>PPCC LINK</td> <td>PPCC LINK</td> <td><a href="#">5681, 5682, 5690, 5691, 5692, 5693, 5694, 5695</a></td> </tr> <tr> <td>12</td> <td>COMM MODULE</td> <td>COMM MODULE</td> <td><a href="#">6681, 7510, 7520, 7581</a></td> </tr> <tr> <td>13</td> <td>PANEL LOSS</td> <td>PANEL LOSS</td> <td><a href="#">7081</a></td> </tr> <tr> <td>14</td> <td>MOTOR STALL</td> <td>MOTOR STALL</td> <td><a href="#">7121</a></td> </tr> <tr> <td>15</td> <td>MOTOR PHASE</td> <td>MOTOR PHASE</td> <td><a href="#">3381</a></td> </tr> </tbody> </table> |   |  |   | Bit | ACS800 fault name |  | ACS880 events indicated by this bit<br>(see <a href="#">Fault tracing</a> , page 487) | ( <a href="#">04.120 = ACS800 Standard ctrl program</a> ) | ( <a href="#">04.120 = ACS800 System ctrl program</a> ) | 0 | SUPPLY PHASE | SUPPLY PHASE | <a href="#">3130</a> | 1 | NO MOT DATA | NO MOTOR DATA | - | 2 | DC UNDERVOLT | DC UNDERVOLT | <a href="#">3220</a> | 3 | Reserved | CABLE TEMP | <a href="#">4000</a> | 4 | RUN ENABLE | RUN DISABLE | <a href="#">AFEB</a> | 5 | ENCODER ERR | ENCODER ERR | <a href="#">7301, 7380, 7381, 73A0, 73A1</a> | 6 | I/O COMM | IO COMM ERR | <a href="#">7080, 7082</a> | 7 | CTRL B TEMP | CTRL B TEMP | - | 8 | EXTERNAL FLT | SELECTABLE | <a href="#">9082</a> | 9 | OVER SWFREQ | OVER SWFREQ | - | 10 | AI < MIN FUNC | AI<MIN FUNC | <a href="#">80A0</a> | 11 | PPCC LINK | PPCC LINK | <a href="#">5681, 5682, 5690, 5691, 5692, 5693, 5694, 5695</a> | 12 | COMM MODULE | COMM MODULE | <a href="#">6681, 7510, 7520, 7581</a> | 13 | PANEL LOSS | PANEL LOSS | <a href="#">7081</a> | 14 | MOTOR STALL | MOTOR STALL | <a href="#">7121</a> | 15 | MOTOR PHASE | MOTOR PHASE | <a href="#">3381</a> |
| Bit   | ACS800 fault name   |  | ACS880 events indicated by this bit<br>(see <a href="#">Fault tracing</a> , page 487) |     |                   |  |   |   |   |   |              |              |                      |   |             |               |   |   |              |              |                      |   |          |            |                      |   |            |             |                      |   |             |             |  |   |          |             |                            |   |             |             |   |   |              |            |                      |   |             |             |   |    |               |             |                      |    |           |           |  |    |             |             |  |    |            |            |                      |    |             |             |                      |    |             |             |                      |
|   | ( <a href="#">04.120 = ACS800 Standard ctrl program</a> ) | ( <a href="#">04.120 = ACS800 System ctrl program</a> )  |   |     |                   |  |   |   |   |   |              |              |                      |   |             |               |   |   |              |              |                      |   |          |            |                      |   |            |             |                      |   |             |             |  |   |          |             |                            |   |             |             |   |   |              |            |                      |   |             |             |   |    |               |             |                      |    |           |           |  |    |             |             |  |    |            |            |                      |    |             |             |                      |    |             |             |                      |
| 0   | SUPPLY PHASE  | SUPPLY PHASE   | <a href="#">3130</a>  |     |                   |  |   |   |   |   |              |              |                      |   |             |               |   |   |              |              |                      |   |          |            |                      |   |            |             |                      |   |             |             |  |   |          |             |                            |   |             |             |   |   |              |            |                      |   |             |             |   |    |               |             |                      |    |           |           |  |    |             |             |  |    |            |            |                      |    |             |             |                      |    |             |             |                      |
| 1   | NO MOT DATA   | NO MOTOR DATA  | -   |     |                   |  |   |   |   |   |              |              |                      |   |             |               |   |   |              |              |                      |   |          |            |                      |   |            |             |                      |   |             |             |  |   |          |             |                            |   |             |             |   |   |              |            |                      |   |             |             |   |    |               |             |                      |    |           |           |  |    |             |             |  |    |            |            |                      |    |             |             |                      |    |             |             |                      |
| 2   | DC UNDERVOLT  | DC UNDERVOLT   | <a href="#">3220</a>  |     |                   |  |   |   |   |   |              |              |                      |   |             |               |   |   |              |              |                      |   |          |            |                      |   |            |             |                      |   |             |             |  |   |          |             |                            |   |             |             |   |   |              |            |                      |   |             |             |   |    |               |             |                      |    |           |           |  |    |             |             |  |    |            |            |                      |    |             |             |                      |    |             |             |                      |
| 3   | Reserved  | CABLE TEMP   | <a href="#">4000</a>  |     |                   |  |   |   |   |   |              |              |                      |   |             |               |   |   |              |              |                      |   |          |            |                      |   |            |             |                      |   |             |             |  |   |          |             |                            |   |             |             |   |   |              |            |                      |   |             |             |   |    |               |             |                      |    |           |           |  |    |             |             |  |    |            |            |                      |    |             |             |                      |    |             |             |                      |
| 4   | RUN ENABLE  | RUN DISABLE  | <a href="#">AFEB</a>  |     |                   |  |   |   |   |   |              |              |                      |   |             |               |   |   |              |              |                      |   |          |            |                      |   |            |             |                      |   |             |             |  |   |          |             |                            |   |             |             |   |   |              |            |                      |   |             |             |   |    |               |             |                      |    |           |           |  |    |             |             |  |    |            |            |                      |    |             |             |                      |    |             |             |                      |
| 5   | ENCODER ERR   | ENCODER ERR  | <a href="#">7301, 7380, 7381, 73A0, 73A1</a>  |     |                   |  |   |   |   |   |              |              |                      |   |             |               |   |   |              |              |                      |   |          |            |                      |   |            |             |                      |   |             |             |  |   |          |             |                            |   |             |             |   |   |              |            |                      |   |             |             |   |    |               |             |                      |    |           |           |  |    |             |             |  |    |            |            |                      |    |             |             |                      |    |             |             |                      |
| 6   | I/O COMM  | IO COMM ERR  | <a href="#">7080, 7082</a>  |     |                   |  |   |   |   |   |              |              |                      |   |             |               |   |   |              |              |                      |   |          |            |                      |   |            |             |                      |   |             |             |  |   |          |             |                            |   |             |             |   |   |              |            |                      |   |             |             |   |    |               |             |                      |    |           |           |  |    |             |             |  |    |            |            |                      |    |             |             |                      |    |             |             |                      |
| 7   | CTRL B TEMP   | CTRL B TEMP  | -   |     |                   |  |   |   |   |   |              |              |                      |   |             |               |   |   |              |              |                      |   |          |            |                      |   |            |             |                      |   |             |             |  |   |          |             |                            |   |             |             |   |   |              |            |                      |   |             |             |   |    |               |             |                      |    |           |           |  |    |             |             |  |    |            |            |                      |    |             |             |                      |    |             |             |                      |
| 8   | EXTERNAL FLT  | SELECTABLE   | <a href="#">9082</a>  |     |                   |  |   |   |   |   |              |              |                      |   |             |               |   |   |              |              |                      |   |          |            |                      |   |            |             |                      |   |             |             |  |   |          |             |                            |   |             |             |   |   |              |            |                      |   |             |             |   |    |               |             |                      |    |           |           |  |    |             |             |  |    |            |            |                      |    |             |             |                      |    |             |             |                      |
| 9   | OVER SWFREQ   | OVER SWFREQ  | -   |     |                   |  |   |   |   |   |              |              |                      |   |             |               |   |   |              |              |                      |   |          |            |                      |   |            |             |                      |   |             |             |  |   |          |             |                            |   |             |             |   |   |              |            |                      |   |             |             |   |    |               |             |                      |    |           |           |  |    |             |             |  |    |            |            |                      |    |             |             |                      |    |             |             |                      |
| 10  | AI < MIN FUNC   | AI<MIN FUNC  | <a href="#">80A0</a>  |     |                   |  |   |   |   |   |              |              |                      |   |             |               |   |   |              |              |                      |   |          |            |                      |   |            |             |                      |   |             |             |  |   |          |             |                            |   |             |             |   |   |              |            |                      |   |             |             |   |    |               |             |                      |    |           |           |  |    |             |             |  |    |            |            |                      |    |             |             |                      |    |             |             |                      |
| 11  | PPCC LINK   | PPCC LINK  | <a href="#">5681, 5682, 5690, 5691, 5692, 5693, 5694, 5695</a>                        |     |                   |  |   |   |   |   |              |              |                      |   |             |               |   |   |              |              |                      |   |          |            |                      |   |            |             |                      |   |             |             |  |   |          |             |                            |   |             |             |   |   |              |            |                      |   |             |             |   |    |               |             |                      |    |           |           |  |    |             |             |  |    |            |            |                      |    |             |             |                      |    |             |             |                      |
| 12  | COMM MODULE   | COMM MODULE  | <a href="#">6681, 7510, 7520, 7581</a>  |     |                   |  |   |   |   |   |              |              |                      |   |             |               |   |   |              |              |                      |   |          |            |                      |   |            |             |                      |   |             |             |  |   |          |             |                            |   |             |             |   |   |              |            |                      |   |             |             |   |    |               |             |                      |    |           |           |  |    |             |             |  |    |            |            |                      |    |             |             |                      |    |             |             |                      |
| 13  | PANEL LOSS  | PANEL LOSS   | <a href="#">7081</a>  |     |                   |  |   |   |   |   |              |              |                      |   |             |               |   |   |              |              |                      |   |          |            |                      |   |            |             |                      |   |             |             |  |   |          |             |                            |   |             |             |   |   |              |            |                      |   |             |             |   |    |               |             |                      |    |           |           |  |    |             |             |  |    |            |            |                      |    |             |             |                      |    |             |             |                      |
| 14  | MOTOR STALL   | MOTOR STALL  | <a href="#">7121</a>  |     |                   |  |   |   |   |   |              |              |                      |   |             |               |   |   |              |              |                      |   |          |            |                      |   |            |             |                      |   |             |             |  |   |          |             |                            |   |             |             |   |   |              |            |                      |   |             |             |   |    |               |             |                      |    |           |           |  |    |             |             |  |    |            |            |                      |    |             |             |                      |    |             |             |                      |
| 15  | MOTOR PHASE   | MOTOR PHASE  | <a href="#">3381</a>  |     |                   |  |   |   |   |   |              |              |                      |   |             |               |   |   |              |              |                      |   |          |            |                      |   |            |             |                      |   |             |             |  |   |          |             |                            |   |             |             |   |   |              |            |                      |   |             |             |   |    |               |             |                      |    |           |           |  |    |             |             |  |    |            |            |                      |    |             |             |                      |    |             |             |                      |
| 0000h...FFFFh   |   | ACS800-compatible fault word 2.  | 1 = 1   |     |                   |  |   |   |   |   |              |              |                      |   |             |               |   |   |              |              |                      |   |          |            |                      |   |            |             |                      |   |             |             |  |   |          |             |                            |   |             |             |   |   |              |            |                      |   |             |             |   |    |               |             |                      |    |           |           |  |    |             |             |  |    |            |            |                      |    |             |             |                      |    |             |             |                      |

| No.  | Name/Value  | Description  | Def/FbEq16   |     |                   |  |   |   |   |   |               |              |                      |   |          |         |   |   |            |              |                      |   |            |            |                      |   |             |             |  |   |             |             |   |   |            |             |   |   |          |            |   |   |          |           |   |   |          |                |   |    |          |               |  |    |          |               |   |    |             |              |                      |    |          |             |   |    |             |             |                      |    |          |              |                      |
|--|---|--|--|-----|-------------------|--|---|---|---|---|---------------|--------------|----------------------|---|----------|---------|---|---|------------|--------------|----------------------|---|------------|------------|----------------------|---|-------------|-------------|--|---|-------------|-------------|---|---|------------|-------------|---|---|----------|------------|---|---|----------|-----------|---|---|----------|----------------|---|----|----------|---------------|--|----|----------|---------------|---|----|-------------|--------------|----------------------|----|----------|-------------|---|----|-------------|-------------|----------------------|----|----------|--------------|----------------------|
| 04.31  | Warning word 1  | <p>ACS800-compatible warning (alarm) word 1.</p> <p>The bit assignments of this word correspond to ALARM WORD 1 in the ACS800. Parameter <a href="#">04.120 Fault/Warning word compatibility</a> determines whether the assignments are according to the ACS800 Standard or ACS800 System control program.</p> <p>Each may indicate several ACS880 warnings as listed below.</p> <p>This parameter is read-only.</p> | -  |     |                   |  |   |   |   |   |               |              |                      |   |          |         |   |   |            |              |                      |   |            |            |                      |   |             |             |  |   |             |             |   |   |            |             |   |   |          |            |   |   |          |           |   |   |          |                |   |    |          |               |  |    |          |               |   |    |             |              |                      |    |          |             |   |    |             |             |                      |    |          |              |                      |
| <table border="1"> <thead> <tr> <th rowspan="2">Bit</th> <th colspan="2">ACS800 alarm name</th> <th rowspan="2">ACS880 events indicated by this bit<br/>(see <a href="#">Fault tracing</a>, page 487)</th> </tr> <tr> <th>(<a href="#">04.120 = ACS800 Standard ctrl program</a>)</th> <th>(<a href="#">04.120 = ACS800 System ctrl program</a>)</th> </tr> </thead> <tbody> <tr> <td>0</td> <td>START INHIBIT</td> <td>START INHIBI</td> <td><a href="#">A5A0</a></td> </tr> <tr> <td>1</td> <td>Reserved</td> <td>EM STOP</td> <td><a href="#">AFE1</a>, <a href="#">AFE2</a></td> </tr> <tr> <td>2</td> <td>THERMISTOR</td> <td>MOTOR TEMP M</td> <td><a href="#">A491</a></td> </tr> <tr> <td>3</td> <td>MOTOR TEMP</td> <td>MOTOR TEMP</td> <td><a href="#">A492</a></td> </tr> <tr> <td>4</td> <td>ACS800 TEMP</td> <td>ACS800 TEMP</td> <td><a href="#">A2BA</a>, <a href="#">A4A9</a>, <a href="#">A4B0</a>, <a href="#">A4B1</a>, <a href="#">A4F6</a></td> </tr> <tr> <td>5</td> <td>ENCODER ERR</td> <td>ENCODER ERR</td> <td><a href="#">A797</a>, <a href="#">A7B0</a>, <a href="#">A7B1</a>, <a href="#">A7E1</a></td> </tr> <tr> <td>6</td> <td>T MEAS ALM</td> <td>T MEAS CIRC</td> <td><a href="#">A490</a>, <a href="#">A5EA</a>, <a href="#">A782</a>, <a href="#">A8A0</a></td> </tr> <tr> <td>7</td> <td>Reserved</td> <td>DIGITAL IO</td> <td>-</td> </tr> <tr> <td>8</td> <td>Reserved</td> <td>ANALOG IO</td> <td>-</td> </tr> <tr> <td>9</td> <td>Reserved</td> <td>EXT DIGITAL IO</td> <td>-</td> </tr> <tr> <td>10</td> <td>Reserved</td> <td>EXT ANALOG IO</td> <td><a href="#">A6E5</a>, <a href="#">A7AA</a>, <a href="#">A7AB</a></td> </tr> <tr> <td>11</td> <td>Reserved</td> <td>CH2 COMM LOSS</td> <td><a href="#">A7CB</a>, <a href="#">AF80</a></td> </tr> <tr> <td>12</td> <td>COMM MODULE</td> <td>MPROT SWITCH</td> <td><a href="#">A981</a></td> </tr> <tr> <td>13</td> <td>Reserved</td> <td>EM STOP DEC</td> <td>-</td> </tr> <tr> <td>14</td> <td>EARTH FAULT</td> <td>EARTH FAULT</td> <td><a href="#">A2B3</a></td> </tr> <tr> <td>15</td> <td>Reserved</td> <td>SAFETY SWITC</td> <td><a href="#">A983</a></td> </tr> </tbody> </table> |   |  |  | Bit | ACS800 alarm name |  | ACS880 events indicated by this bit<br>(see <a href="#">Fault tracing</a> , page 487) | ( <a href="#">04.120 = ACS800 Standard ctrl program</a> ) | ( <a href="#">04.120 = ACS800 System ctrl program</a> ) | 0 | START INHIBIT | START INHIBI | <a href="#">A5A0</a> | 1 | Reserved | EM STOP | <a href="#">AFE1</a> , <a href="#">AFE2</a> | 2 | THERMISTOR | MOTOR TEMP M | <a href="#">A491</a> | 3 | MOTOR TEMP | MOTOR TEMP | <a href="#">A492</a> | 4 | ACS800 TEMP | ACS800 TEMP | <a href="#">A2BA</a> , <a href="#">A4A9</a> , <a href="#">A4B0</a> , <a href="#">A4B1</a> , <a href="#">A4F6</a> | 5 | ENCODER ERR | ENCODER ERR | <a href="#">A797</a> , <a href="#">A7B0</a> , <a href="#">A7B1</a> , <a href="#">A7E1</a> | 6 | T MEAS ALM | T MEAS CIRC | <a href="#">A490</a> , <a href="#">A5EA</a> , <a href="#">A782</a> , <a href="#">A8A0</a> | 7 | Reserved | DIGITAL IO | - | 8 | Reserved | ANALOG IO | - | 9 | Reserved | EXT DIGITAL IO | - | 10 | Reserved | EXT ANALOG IO | <a href="#">A6E5</a> , <a href="#">A7AA</a> , <a href="#">A7AB</a> | 11 | Reserved | CH2 COMM LOSS | <a href="#">A7CB</a> , <a href="#">AF80</a> | 12 | COMM MODULE | MPROT SWITCH | <a href="#">A981</a> | 13 | Reserved | EM STOP DEC | - | 14 | EARTH FAULT | EARTH FAULT | <a href="#">A2B3</a> | 15 | Reserved | SAFETY SWITC | <a href="#">A983</a> |
| Bit  | ACS800 alarm name   |  | ACS880 events indicated by this bit<br>(see <a href="#">Fault tracing</a> , page 487)                            |     |                   |  |   |   |   |   |               |              |                      |   |          |         |   |   |            |              |                      |   |            |            |                      |   |             |             |  |   |             |             |   |   |            |             |   |   |          |            |   |   |          |           |   |   |          |                |   |    |          |               |  |    |          |               |   |    |             |              |                      |    |          |             |   |    |             |             |                      |    |          |              |                      |
|  | ( <a href="#">04.120 = ACS800 Standard ctrl program</a> ) | ( <a href="#">04.120 = ACS800 System ctrl program</a> )  |  |     |                   |  |   |   |   |   |               |              |                      |   |          |         |   |   |            |              |                      |   |            |            |                      |   |             |             |  |   |             |             |   |   |            |             |   |   |          |            |   |   |          |           |   |   |          |                |   |    |          |               |  |    |          |               |   |    |             |              |                      |    |          |             |   |    |             |             |                      |    |          |              |                      |
| 0  | START INHIBIT   | START INHIBI   | <a href="#">A5A0</a>   |     |                   |  |   |   |   |   |               |              |                      |   |          |         |   |   |            |              |                      |   |            |            |                      |   |             |             |  |   |             |             |   |   |            |             |   |   |          |            |   |   |          |           |   |   |          |                |   |    |          |               |  |    |          |               |   |    |             |              |                      |    |          |             |   |    |             |             |                      |    |          |              |                      |
| 1  | Reserved  | EM STOP  | <a href="#">AFE1</a> , <a href="#">AFE2</a>  |     |                   |  |   |   |   |   |               |              |                      |   |          |         |   |   |            |              |                      |   |            |            |                      |   |             |             |  |   |             |             |   |   |            |             |   |   |          |            |   |   |          |           |   |   |          |                |   |    |          |               |  |    |          |               |   |    |             |              |                      |    |          |             |   |    |             |             |                      |    |          |              |                      |
| 2  | THERMISTOR  | MOTOR TEMP M   | <a href="#">A491</a>   |     |                   |  |   |   |   |   |               |              |                      |   |          |         |   |   |            |              |                      |   |            |            |                      |   |             |             |  |   |             |             |   |   |            |             |   |   |          |            |   |   |          |           |   |   |          |                |   |    |          |               |  |    |          |               |   |    |             |              |                      |    |          |             |   |    |             |             |                      |    |          |              |                      |
| 3  | MOTOR TEMP  | MOTOR TEMP   | <a href="#">A492</a>   |     |                   |  |   |   |   |   |               |              |                      |   |          |         |   |   |            |              |                      |   |            |            |                      |   |             |             |  |   |             |             |   |   |            |             |   |   |          |            |   |   |          |           |   |   |          |                |   |    |          |               |  |    |          |               |   |    |             |              |                      |    |          |             |   |    |             |             |                      |    |          |              |                      |
| 4  | ACS800 TEMP   | ACS800 TEMP  | <a href="#">A2BA</a> , <a href="#">A4A9</a> , <a href="#">A4B0</a> , <a href="#">A4B1</a> , <a href="#">A4F6</a> |     |                   |  |   |   |   |   |               |              |                      |   |          |         |   |   |            |              |                      |   |            |            |                      |   |             |             |  |   |             |             |   |   |            |             |   |   |          |            |   |   |          |           |   |   |          |                |   |    |          |               |  |    |          |               |   |    |             |              |                      |    |          |             |   |    |             |             |                      |    |          |              |                      |
| 5  | ENCODER ERR   | ENCODER ERR  | <a href="#">A797</a> , <a href="#">A7B0</a> , <a href="#">A7B1</a> , <a href="#">A7E1</a>                        |     |                   |  |   |   |   |   |               |              |                      |   |          |         |   |   |            |              |                      |   |            |            |                      |   |             |             |  |   |             |             |   |   |            |             |   |   |          |            |   |   |          |           |   |   |          |                |   |    |          |               |  |    |          |               |   |    |             |              |                      |    |          |             |   |    |             |             |                      |    |          |              |                      |
| 6  | T MEAS ALM  | T MEAS CIRC  | <a href="#">A490</a> , <a href="#">A5EA</a> , <a href="#">A782</a> , <a href="#">A8A0</a>                        |     |                   |  |   |   |   |   |               |              |                      |   |          |         |   |   |            |              |                      |   |            |            |                      |   |             |             |  |   |             |             |   |   |            |             |   |   |          |            |   |   |          |           |   |   |          |                |   |    |          |               |  |    |          |               |   |    |             |              |                      |    |          |             |   |    |             |             |                      |    |          |              |                      |
| 7  | Reserved  | DIGITAL IO   | -  |     |                   |  |   |   |   |   |               |              |                      |   |          |         |   |   |            |              |                      |   |            |            |                      |   |             |             |  |   |             |             |   |   |            |             |   |   |          |            |   |   |          |           |   |   |          |                |   |    |          |               |  |    |          |               |   |    |             |              |                      |    |          |             |   |    |             |             |                      |    |          |              |                      |
| 8  | Reserved  | ANALOG IO  | -  |     |                   |  |   |   |   |   |               |              |                      |   |          |         |   |   |            |              |                      |   |            |            |                      |   |             |             |  |   |             |             |   |   |            |             |   |   |          |            |   |   |          |           |   |   |          |                |   |    |          |               |  |    |          |               |   |    |             |              |                      |    |          |             |   |    |             |             |                      |    |          |              |                      |
| 9  | Reserved  | EXT DIGITAL IO   | -  |     |                   |  |   |   |   |   |               |              |                      |   |          |         |   |   |            |              |                      |   |            |            |                      |   |             |             |  |   |             |             |   |   |            |             |   |   |          |            |   |   |          |           |   |   |          |                |   |    |          |               |  |    |          |               |   |    |             |              |                      |    |          |             |   |    |             |             |                      |    |          |              |                      |
| 10   | Reserved  | EXT ANALOG IO  | <a href="#">A6E5</a> , <a href="#">A7AA</a> , <a href="#">A7AB</a>   |     |                   |  |   |   |   |   |               |              |                      |   |          |         |   |   |            |              |                      |   |            |            |                      |   |             |             |  |   |             |             |   |   |            |             |   |   |          |            |   |   |          |           |   |   |          |                |   |    |          |               |  |    |          |               |   |    |             |              |                      |    |          |             |   |    |             |             |                      |    |          |              |                      |
| 11   | Reserved  | CH2 COMM LOSS  | <a href="#">A7CB</a> , <a href="#">AF80</a>  |     |                   |  |   |   |   |   |               |              |                      |   |          |         |   |   |            |              |                      |   |            |            |                      |   |             |             |  |   |             |             |   |   |            |             |   |   |          |            |   |   |          |           |   |   |          |                |   |    |          |               |  |    |          |               |   |    |             |              |                      |    |          |             |   |    |             |             |                      |    |          |              |                      |
| 12   | COMM MODULE   | MPROT SWITCH   | <a href="#">A981</a>   |     |                   |  |   |   |   |   |               |              |                      |   |          |         |   |   |            |              |                      |   |            |            |                      |   |             |             |  |   |             |             |   |   |            |             |   |   |          |            |   |   |          |           |   |   |          |                |   |    |          |               |  |    |          |               |   |    |             |              |                      |    |          |             |   |    |             |             |                      |    |          |              |                      |
| 13   | Reserved  | EM STOP DEC  | -  |     |                   |  |   |   |   |   |               |              |                      |   |          |         |   |   |            |              |                      |   |            |            |                      |   |             |             |  |   |             |             |   |   |            |             |   |   |          |            |   |   |          |           |   |   |          |                |   |    |          |               |  |    |          |               |   |    |             |              |                      |    |          |             |   |    |             |             |                      |    |          |              |                      |
| 14   | EARTH FAULT   | EARTH FAULT  | <a href="#">A2B3</a>   |     |                   |  |   |   |   |   |               |              |                      |   |          |         |   |   |            |              |                      |   |            |            |                      |   |             |             |  |   |             |             |   |   |            |             |   |   |          |            |   |   |          |           |   |   |          |                |   |    |          |               |  |    |          |               |   |    |             |              |                      |    |          |             |   |    |             |             |                      |    |          |              |                      |
| 15   | Reserved  | SAFETY SWITC   | <a href="#">A983</a>   |     |                   |  |   |   |   |   |               |              |                      |   |          |         |   |   |            |              |                      |   |            |            |                      |   |             |             |  |   |             |             |   |   |            |             |   |   |          |            |   |   |          |           |   |   |          |                |   |    |          |               |  |    |          |               |   |    |             |              |                      |    |          |             |   |    |             |             |                      |    |          |              |                      |
| 0000h...FFFFh  | ACS800-compatible warning (alarm) word 1.                 |  | 1 = 1  |     |                   |  |   |   |   |   |               |              |                      |   |          |         |   |   |            |              |                      |   |            |            |                      |   |             |             |  |   |             |             |   |   |            |             |   |   |          |            |   |   |          |           |   |   |          |                |   |    |          |               |  |    |          |               |   |    |             |              |                      |    |          |             |   |    |             |             |                      |    |          |              |                      |

| No.   | Name/Value  | Description  | Def/FbEq16  |     |                   |             |   |   |   |   |            |   |                      |     |           |           |             |   |          |              |   |   |          |            |                      |   |         |              |   |   |          |              |                      |   |          |          |   |   |              |              |   |   |             |              |   |   |             |             |                      |    |               |             |                      |    |          |             |   |    |          |              |   |    |            |            |                      |    |          |              |                      |    |          |           |   |
|---|---|--|---|-----|-------------------|-------------|---|---|---|---|------------|---|----------------------|-----|-----------|-----------|-------------|---|----------|--------------|---|---|----------|------------|----------------------|---|---------|--------------|---|---|----------|--------------|----------------------|---|----------|----------|---|---|--------------|--------------|---|---|-------------|--------------|---|---|-------------|-------------|----------------------|----|---------------|-------------|----------------------|----|----------|-------------|---|----|----------|--------------|---|----|------------|------------|----------------------|----|----------|--------------|----------------------|----|----------|-----------|---|
| 04.32   | Warning word 2  | <p>ACS800-compatible warning (alarm) word 2.</p> <p>The bit assignments of this word correspond to ALARM WORD 2 in the ACS800. Parameter <a href="#">04.120 Fault/Warning word compatibility</a> determines whether the bit assignments are according to the ACS800 Standard or ACS800 System control program.</p> <p>Each may indicate several ACS880 warnings as listed below.</p> <p>This parameter is read-only.</p> | -   |     |                   |             |   |   |   |   |            |   |                      |     |           |           |             |   |          |              |   |   |          |            |                      |   |         |              |   |   |          |              |                      |   |          |          |   |   |              |              |   |   |             |              |   |   |             |             |                      |    |               |             |                      |    |          |             |   |    |          |              |   |    |            |            |                      |    |          |              |                      |    |          |           |   |
| <table border="1"> <thead> <tr> <th rowspan="2">Bit</th> <th colspan="2">ACS800 alarm name</th> <th rowspan="2">ACS880 events indicated by this bit<br/>(see <a href="#">Fault tracing</a>, page 487)</th> </tr> <tr> <th>(<a href="#">04.120 = ACS800 Standard ctrl program</a>)</th> <th>(<a href="#">04.120 = ACS800 System ctrl program</a>)</th> </tr> </thead> <tbody> <tr> <td>0</td> <td>Reserved</td> <td>MOTOR FAN</td> <td><a href="#">A781</a></td> </tr> <tr> <td>1</td> <td>UNDERLOAD</td> <td>UNDERLOAD</td> <td>-</td> </tr> <tr> <td>2</td> <td>Reserved</td> <td>INV OVERLOAD</td> <td>-</td> </tr> <tr> <td>3</td> <td>Reserved</td> <td>CABLE TEMP</td> <td><a href="#">A480</a></td> </tr> <tr> <td>4</td> <td>ENCODER</td> <td>ENCODER A&lt;&gt;B</td> <td>-</td> </tr> <tr> <td>5</td> <td>Reserved</td> <td>FAN OVERTEMP</td> <td><a href="#">A984</a></td> </tr> <tr> <td>6</td> <td>Reserved</td> <td>Reserved</td> <td>-</td> </tr> <tr> <td>7</td> <td>POWFAIL FILE</td> <td>POWFAIL FILE</td> <td>-</td> </tr> <tr> <td>8</td> <td>ALM (OS_17)</td> <td>POWDOWN FILE</td> <td>-</td> </tr> <tr> <td>9</td> <td>MOTOR STALL</td> <td>MOTOR STALL</td> <td><a href="#">A780</a></td> </tr> <tr> <td>10</td> <td>AI &lt; MIN FUNC</td> <td>AI&lt;MIN FUNC</td> <td><a href="#">A8A0</a></td> </tr> <tr> <td>11</td> <td>Reserved</td> <td>COMM MODULE</td> <td><a href="#">A6D1</a>, <a href="#">A6D2</a>, <a href="#">A7C1</a>, <a href="#">A7C2</a>, <a href="#">A7CA</a>, <a href="#">A7CE</a></td> </tr> <tr> <td>12</td> <td>Reserved</td> <td>BATT FAILURE</td> <td>-</td> </tr> <tr> <td>13</td> <td>PANEL LOSS</td> <td>PANEL LOSS</td> <td><a href="#">A7EE</a></td> </tr> <tr> <td>14</td> <td>Reserved</td> <td>DC UNDERVOLT</td> <td><a href="#">A3A2</a></td> </tr> <tr> <td>15</td> <td>Reserved</td> <td>RESTARTED</td> <td>-</td> </tr> </tbody> </table> |   |  |   | Bit | ACS800 alarm name |             | ACS880 events indicated by this bit<br>(see <a href="#">Fault tracing</a> , page 487) | ( <a href="#">04.120 = ACS800 Standard ctrl program</a> ) | ( <a href="#">04.120 = ACS800 System ctrl program</a> )                                       | 0 | Reserved   | MOTOR FAN   | <a href="#">A781</a> | 1   | UNDERLOAD | UNDERLOAD | -           | 2   | Reserved | INV OVERLOAD | - | 3 | Reserved | CABLE TEMP | <a href="#">A480</a> | 4 | ENCODER | ENCODER A<>B | - | 5 | Reserved | FAN OVERTEMP | <a href="#">A984</a> | 6 | Reserved | Reserved | - | 7 | POWFAIL FILE | POWFAIL FILE | - | 8 | ALM (OS_17) | POWDOWN FILE | - | 9 | MOTOR STALL | MOTOR STALL | <a href="#">A780</a> | 10 | AI < MIN FUNC | AI<MIN FUNC | <a href="#">A8A0</a> | 11 | Reserved | COMM MODULE | <a href="#">A6D1</a> , <a href="#">A6D2</a> , <a href="#">A7C1</a> , <a href="#">A7C2</a> , <a href="#">A7CA</a> , <a href="#">A7CE</a> | 12 | Reserved | BATT FAILURE | - | 13 | PANEL LOSS | PANEL LOSS | <a href="#">A7EE</a> | 14 | Reserved | DC UNDERVOLT | <a href="#">A3A2</a> | 15 | Reserved | RESTARTED | - |
| Bit   | ACS800 alarm name   |  | ACS880 events indicated by this bit<br>(see <a href="#">Fault tracing</a> , page 487)   |     |                   |             |   |   |   |   |            |   |                      |     |           |           |             |   |          |              |   |   |          |            |                      |   |         |              |   |   |          |              |                      |   |          |          |   |   |              |              |   |   |             |              |   |   |             |             |                      |    |               |             |                      |    |          |             |   |    |          |              |   |    |            |            |                      |    |          |              |                      |    |          |           |   |
|   | ( <a href="#">04.120 = ACS800 Standard ctrl program</a> ) | ( <a href="#">04.120 = ACS800 System ctrl program</a> )  |   |     |                   |             |   |   |   |   |            |   |                      |     |           |           |             |   |          |              |   |   |          |            |                      |   |         |              |   |   |          |              |                      |   |          |          |   |   |              |              |   |   |             |              |   |   |             |             |                      |    |               |             |                      |    |          |             |   |    |          |              |   |    |            |            |                      |    |          |              |                      |    |          |           |   |
| 0   | Reserved  | MOTOR FAN  | <a href="#">A781</a>  |     |                   |             |   |   |   |   |            |   |                      |     |           |           |             |   |          |              |   |   |          |            |                      |   |         |              |   |   |          |              |                      |   |          |          |   |   |              |              |   |   |             |              |   |   |             |             |                      |    |               |             |                      |    |          |             |   |    |          |              |   |    |            |            |                      |    |          |              |                      |    |          |           |   |
| 1   | UNDERLOAD   | UNDERLOAD  | -   |     |                   |             |   |   |   |   |            |   |                      |     |           |           |             |   |          |              |   |   |          |            |                      |   |         |              |   |   |          |              |                      |   |          |          |   |   |              |              |   |   |             |              |   |   |             |             |                      |    |               |             |                      |    |          |             |   |    |          |              |   |    |            |            |                      |    |          |              |                      |    |          |           |   |
| 2   | Reserved  | INV OVERLOAD   | -   |     |                   |             |   |   |   |   |            |   |                      |     |           |           |             |   |          |              |   |   |          |            |                      |   |         |              |   |   |          |              |                      |   |          |          |   |   |              |              |   |   |             |              |   |   |             |             |                      |    |               |             |                      |    |          |             |   |    |          |              |   |    |            |            |                      |    |          |              |                      |    |          |           |   |
| 3   | Reserved  | CABLE TEMP   | <a href="#">A480</a>  |     |                   |             |   |   |   |   |            |   |                      |     |           |           |             |   |          |              |   |   |          |            |                      |   |         |              |   |   |          |              |                      |   |          |          |   |   |              |              |   |   |             |              |   |   |             |             |                      |    |               |             |                      |    |          |             |   |    |          |              |   |    |            |            |                      |    |          |              |                      |    |          |           |   |
| 4   | ENCODER   | ENCODER A<>B   | -   |     |                   |             |   |   |   |   |            |   |                      |     |           |           |             |   |          |              |   |   |          |            |                      |   |         |              |   |   |          |              |                      |   |          |          |   |   |              |              |   |   |             |              |   |   |             |             |                      |    |               |             |                      |    |          |             |   |    |          |              |   |    |            |            |                      |    |          |              |                      |    |          |           |   |
| 5   | Reserved  | FAN OVERTEMP   | <a href="#">A984</a>  |     |                   |             |   |   |   |   |            |   |                      |     |           |           |             |   |          |              |   |   |          |            |                      |   |         |              |   |   |          |              |                      |   |          |          |   |   |              |              |   |   |             |              |   |   |             |             |                      |    |               |             |                      |    |          |             |   |    |          |              |   |    |            |            |                      |    |          |              |                      |    |          |           |   |
| 6   | Reserved  | Reserved   | -   |     |                   |             |   |   |   |   |            |   |                      |     |           |           |             |   |          |              |   |   |          |            |                      |   |         |              |   |   |          |              |                      |   |          |          |   |   |              |              |   |   |             |              |   |   |             |             |                      |    |               |             |                      |    |          |             |   |    |          |              |   |    |            |            |                      |    |          |              |                      |    |          |           |   |
| 7   | POWFAIL FILE  | POWFAIL FILE   | -   |     |                   |             |   |   |   |   |            |   |                      |     |           |           |             |   |          |              |   |   |          |            |                      |   |         |              |   |   |          |              |                      |   |          |          |   |   |              |              |   |   |             |              |   |   |             |             |                      |    |               |             |                      |    |          |             |   |    |          |              |   |    |            |            |                      |    |          |              |                      |    |          |           |   |
| 8   | ALM (OS_17)   | POWDOWN FILE   | -   |     |                   |             |   |   |   |   |            |   |                      |     |           |           |             |   |          |              |   |   |          |            |                      |   |         |              |   |   |          |              |                      |   |          |          |   |   |              |              |   |   |             |              |   |   |             |             |                      |    |               |             |                      |    |          |             |   |    |          |              |   |    |            |            |                      |    |          |              |                      |    |          |           |   |
| 9   | MOTOR STALL   | MOTOR STALL  | <a href="#">A780</a>  |     |                   |             |   |   |   |   |            |   |                      |     |           |           |             |   |          |              |   |   |          |            |                      |   |         |              |   |   |          |              |                      |   |          |          |   |   |              |              |   |   |             |              |   |   |             |             |                      |    |               |             |                      |    |          |             |   |    |          |              |   |    |            |            |                      |    |          |              |                      |    |          |           |   |
| 10  | AI < MIN FUNC   | AI<MIN FUNC  | <a href="#">A8A0</a>  |     |                   |             |   |   |   |   |            |   |                      |     |           |           |             |   |          |              |   |   |          |            |                      |   |         |              |   |   |          |              |                      |   |          |          |   |   |              |              |   |   |             |              |   |   |             |             |                      |    |               |             |                      |    |          |             |   |    |          |              |   |    |            |            |                      |    |          |              |                      |    |          |           |   |
| 11  | Reserved  | COMM MODULE  | <a href="#">A6D1</a> , <a href="#">A6D2</a> , <a href="#">A7C1</a> , <a href="#">A7C2</a> , <a href="#">A7CA</a> , <a href="#">A7CE</a> |     |                   |             |   |   |   |   |            |   |                      |     |           |           |             |   |          |              |   |   |          |            |                      |   |         |              |   |   |          |              |                      |   |          |          |   |   |              |              |   |   |             |              |   |   |             |             |                      |    |               |             |                      |    |          |             |   |    |          |              |   |    |            |            |                      |    |          |              |                      |    |          |           |   |
| 12  | Reserved  | BATT FAILURE   | -   |     |                   |             |   |   |   |   |            |   |                      |     |           |           |             |   |          |              |   |   |          |            |                      |   |         |              |   |   |          |              |                      |   |          |          |   |   |              |              |   |   |             |              |   |   |             |             |                      |    |               |             |                      |    |          |             |   |    |          |              |   |    |            |            |                      |    |          |              |                      |    |          |           |   |
| 13  | PANEL LOSS  | PANEL LOSS   | <a href="#">A7EE</a>  |     |                   |             |   |   |   |   |            |   |                      |     |           |           |             |   |          |              |   |   |          |            |                      |   |         |              |   |   |          |              |                      |   |          |          |   |   |              |              |   |   |             |              |   |   |             |             |                      |    |               |             |                      |    |          |             |   |    |          |              |   |    |            |            |                      |    |          |              |                      |    |          |           |   |
| 14  | Reserved  | DC UNDERVOLT   | <a href="#">A3A2</a>  |     |                   |             |   |   |   |   |            |   |                      |     |           |           |             |   |          |              |   |   |          |            |                      |   |         |              |   |   |          |              |                      |   |          |          |   |   |              |              |   |   |             |              |   |   |             |             |                      |    |               |             |                      |    |          |             |   |    |          |              |   |    |            |            |                      |    |          |              |                      |    |          |           |   |
| 15  | Reserved  | RESTARTED  | -   |     |                   |             |   |   |   |   |            |   |                      |     |           |           |             |   |          |              |   |   |          |            |                      |   |         |              |   |   |          |              |                      |   |          |          |   |   |              |              |   |   |             |              |   |   |             |             |                      |    |               |             |                      |    |          |             |   |    |          |              |   |    |            |            |                      |    |          |              |                      |    |          |           |   |
|   | 0000h...FFFFh   | ACS800-compatible warning (alarm) word 2.  | 1 = 1   |     |                   |             |   |   |   |   |            |   |                      |     |           |           |             |   |          |              |   |   |          |            |                      |   |         |              |   |   |          |              |                      |   |          |          |   |   |              |              |   |   |             |              |   |   |             |             |                      |    |               |             |                      |    |          |             |   |    |          |              |   |    |            |            |                      |    |          |              |                      |    |          |           |   |
| 04.40   | Event word 1  | <p>User-defined event word. This word collects the status of the events (warnings, faults or pure events) selected by parameters <a href="#">04.41...04.72</a>.</p> <p>For each event, an auxiliary code can optionally be specified for filtering.</p> <p>This parameter is read-only.</p>  | -   |     |                   |             |   |   |   |   |            |   |                      |     |           |           |             |   |          |              |   |   |          |            |                      |   |         |              |   |   |          |              |                      |   |          |          |   |   |              |              |   |   |             |              |   |   |             |             |                      |    |               |             |                      |    |          |             |   |    |          |              |   |    |            |            |                      |    |          |              |                      |    |          |           |   |
| <table border="1"> <thead> <tr> <th>Bit</th> <th>Name</th> <th>Description</th> </tr> </thead> <tbody> <tr> <td>0</td> <td>User bit 0</td> <td>1 = Event selected by parameters <a href="#">04.41</a> (and <a href="#">04.42</a>) is active</td> </tr> <tr> <td>1</td> <td>User bit 1</td> <td>1 = Event selected by parameters <a href="#">04.43</a> (and <a href="#">04.44</a>) is active</td> </tr> <tr> <td>...</td> <td>...</td> <td>...</td> </tr> <tr> <td>15</td> <td>User bit 15</td> <td>1 = Event selected by parameters <a href="#">04.71</a> (and <a href="#">04.72</a>) is active</td> </tr> </tbody> </table>  |   |  |   | Bit | Name              | Description | 0   | User bit 0  | 1 = Event selected by parameters <a href="#">04.41</a> (and <a href="#">04.42</a> ) is active | 1 | User bit 1 | 1 = Event selected by parameters <a href="#">04.43</a> (and <a href="#">04.44</a> ) is active | ...                  | ... | ...       | 15        | User bit 15 | 1 = Event selected by parameters <a href="#">04.71</a> (and <a href="#">04.72</a> ) is active |          |              |   |   |          |            |                      |   |         |              |   |   |          |              |                      |   |          |          |   |   |              |              |   |   |             |              |   |   |             |             |                      |    |               |             |                      |    |          |             |   |    |          |              |   |    |            |            |                      |    |          |              |                      |    |          |           |   |
| Bit   | Name  | Description  |   |     |                   |             |   |   |   |   |            |   |                      |     |           |           |             |   |          |              |   |   |          |            |                      |   |         |              |   |   |          |              |                      |   |          |          |   |   |              |              |   |   |             |              |   |   |             |             |                      |    |               |             |                      |    |          |             |   |    |          |              |   |    |            |            |                      |    |          |              |                      |    |          |           |   |
| 0   | User bit 0  | 1 = Event selected by parameters <a href="#">04.41</a> (and <a href="#">04.42</a> ) is active  |   |     |                   |             |   |   |   |   |            |   |                      |     |           |           |             |   |          |              |   |   |          |            |                      |   |         |              |   |   |          |              |                      |   |          |          |   |   |              |              |   |   |             |              |   |   |             |             |                      |    |               |             |                      |    |          |             |   |    |          |              |   |    |            |            |                      |    |          |              |                      |    |          |           |   |
| 1   | User bit 1  | 1 = Event selected by parameters <a href="#">04.43</a> (and <a href="#">04.44</a> ) is active  |   |     |                   |             |   |   |   |   |            |   |                      |     |           |           |             |   |          |              |   |   |          |            |                      |   |         |              |   |   |          |              |                      |   |          |          |   |   |              |              |   |   |             |              |   |   |             |             |                      |    |               |             |                      |    |          |             |   |    |          |              |   |    |            |            |                      |    |          |              |                      |    |          |           |   |
| ...   | ...   | ...  |   |     |                   |             |   |   |   |   |            |   |                      |     |           |           |             |   |          |              |   |   |          |            |                      |   |         |              |   |   |          |              |                      |   |          |          |   |   |              |              |   |   |             |              |   |   |             |             |                      |    |               |             |                      |    |          |             |   |    |          |              |   |    |            |            |                      |    |          |              |                      |    |          |           |   |
| 15  | User bit 15   | 1 = Event selected by parameters <a href="#">04.71</a> (and <a href="#">04.72</a> ) is active  |   |     |                   |             |   |   |   |   |            |   |                      |     |           |           |             |   |          |              |   |   |          |            |                      |   |         |              |   |   |          |              |                      |   |          |          |   |   |              |              |   |   |             |              |   |   |             |             |                      |    |               |             |                      |    |          |             |   |    |          |              |   |    |            |            |                      |    |          |              |                      |    |          |           |   |
|   | 0000h...FFFFh   | User-defined event word.   | 1 = 1   |     |                   |             |   |   |   |   |            |   |                      |     |           |           |             |   |          |              |   |   |          |            |                      |   |         |              |   |   |          |              |                      |   |          |          |   |   |              |              |   |   |             |              |   |   |             |             |                      |    |               |             |                      |    |          |             |   |    |          |              |   |    |            |            |                      |    |          |              |                      |    |          |           |   |

| No.    | Name/Value                              | Description  | Def/FbEq16   |
|--------|---|--|--------------|
| 04.41  | <i>Event word 1 bit 0 code</i>          | Selects the hexadecimal code of an event (warning, fault or pure event) whose status is shown as bit 0 of <i>04.40 Event word 1</i> . The event codes are listed in chapter <i>Fault tracing</i> (page 487).   | 0000h        |
|        | 0000h...FFFFh                           | Code of event.   | 1 = 1        |
| 04.42  | <i>Event word 1 bit 0 aux code</i>      | Specifies an auxiliary code for the event selected by the previous parameter. The selected event is indicated by the event word only if its auxiliary code matches the value of this parameter.<br>With a value of 0000 0000h, the event word will indicate the event regardless of the auxiliary code.                          | 0000 0000h   |
|        | 0000 0000h ...<br>FFFF FFFFh            | Code of warning, fault or pure event.  | 1 = 1        |
| 04.43  | <i>Event word 1 bit 1 code</i>          | Selects the hexadecimal code of an event (warning, fault or pure event) whose status is shown as bit 1 of <i>04.40 Event word 1</i> . The event codes are listed in chapter <i>Fault tracing</i> (page 487).   | 0000h        |
|        | 0000h...FFFFh                           | Code of event.   | 1 = 1        |
| 04.44  | <i>Event word 1 bit 1 aux code</i>      | Specifies an auxiliary code for the event selected by the previous parameter. The selected event is indicated by the event word only if its auxiliary code matches the value of this parameter.<br>With a value of 0000 0000h, the event word will indicate the event regardless of the auxiliary code.                          | 0000 0000h   |
|        | 0000 0000h ...<br>FFFF FFFFh            | Code of warning, fault or pure event.  | 1 = 1        |
| ...    | ...                                     | ...  | ...          |
| 04.71  | <i>Event word 1 bit 15 code</i>         | Selects the hexadecimal code of an event (warning, fault or pure event) whose status is shown as bit 15 of <i>04.40 Event word 1</i> . The event codes are listed in chapter <i>Fault tracing</i> (page 487).  | 0000h        |
|        | 0000h...FFFFh                           | Code of event.   | 1 = 1        |
| 04.72  | <i>Event word 1 bit 15 aux code</i>     | Specifies an auxiliary code for the event selected by the previous parameter. The selected event is indicated by the event word only if its auxiliary code matches the value of this parameter.<br>With a value of 0000 0000h, the event word will indicate the event regardless of the auxiliary code.                          | 0000 0000h   |
|        | 0000 0000h ...<br>FFFF FFFFh            | Code of warning, fault or pure event.  | 1 = 1        |
| 04.120 | <i>Fault/Warning word compatibility</i> | Selects whether the bit assignments of parameters <i>04.21...04.32</i> correspond to the ACS800 Standard control program or the ACS800 System control program.   | <i>False</i> |
|        | ACS800 Standard ctrl program            | The bit assignments of parameters <i>04.21...04.32</i> correspond to the ACS800 Standard control program as follows:<br><i>04.21 Fault word 1</i> : 03.05 FAULT WORD 1<br><i>04.22 Fault word 2</i> : 03.06 FAULT WORD 2<br><i>04.31 Warning word 1</i> : 03.08 ALARM WORD 1<br><i>04.32 Warning word 2</i> : 03.09 ALARM WORD 2 | 0            |

| No.  | Name/Value                               | Description   | Def/FbEq16 |     |      |       |        |          |  |    |             |  |    |                     |   |         |          |  |
|--|--|---|------------|-----|------|-------|--------|----------|--|----|-------------|--|----|---------------------|---|---------|----------|--|
|  | ACS800 System ctrl program               | The bit assignments of parameters <a href="#">04.21</a> ... <a href="#">04.32</a> correspond to the ACS800 System control program as follows:<br><a href="#">04.21 Fault word 1</a> : 09.01 FAULT WORD 1<br><a href="#">04.22 Fault word 2</a> : 09.02 FAULT WORD 2<br><a href="#">04.31 Warning word 1</a> : 09.04 ALARM WORD 1<br><a href="#">04.32 Warning word 2</a> : 09.05 ALARM WORD 2 | 1          |     |      |       |        |          |  |    |             |  |    |                     |   |         |          |  |
| <b>05 Diagnostics</b>  |  | Various run-time-type counters and measurements related to drive maintenance.<br>All parameters in this group are read-only unless otherwise noted.   |            |     |      |       |        |          |  |    |             |  |    |                     |   |         |          |  |
| <a href="#">05.01</a>  | <a href="#">On-time counter</a>          | On-time counter. The counter runs when the drive is powered.  | -          |     |      |       |        |          |  |    |             |  |    |                     |   |         |          |  |
|  | 0...65535 d                              | On-time counter.  | 1 = 1 d    |     |      |       |        |          |  |    |             |  |    |                     |   |         |          |  |
| <a href="#">05.02</a>  | <a href="#">Run-time counter</a>         | Motor run-time counter. The counter runs when the inverter modulates.   | -          |     |      |       |        |          |  |    |             |  |    |                     |   |         |          |  |
|  | 0...65535 d                              | Motor run-time counter.   | 1 = 1 d    |     |      |       |        |          |  |    |             |  |    |                     |   |         |          |  |
| <a href="#">05.04</a>  | <a href="#">Fan on-time counter</a>      | Running time of the drive cooling fan. Can be reset from the control panel by keeping Reset depressed for over 3 seconds.   | -          |     |      |       |        |          |  |    |             |  |    |                     |   |         |          |  |
|  | 0...65535 d                              | Cooling fan run-time counter.   | 1 = 1 d    |     |      |       |        |          |  |    |             |  |    |                     |   |         |          |  |
| <a href="#">05.11</a>  | <a href="#">Inverter temperature</a>     | Estimated drive temperature in percent of fault limit. The actual trip temperature varies according to the type of the drive.<br>0.0% = 0 °C (32 °F)<br>94% approx. = Warning limit<br>100.0% = Fault limit   | -          |     |      |       |        |          |  |    |             |  |    |                     |   |         |          |  |
|  | -40.0 ... 160.0%                         | Drive temperature in percent.   | 1 = 1%     |     |      |       |        |          |  |    |             |  |    |                     |   |         |          |  |
| <a href="#">05.22</a>  | <a href="#">Diagnostic word 3</a>        | Diagnostic word 3.  | -          |     |      |       |        |          |  |    |             |  |    |                     |   |         |          |  |
| <table border="1"> <thead> <tr> <th>Bit</th> <th>Name</th> <th>Value</th> </tr> </thead> <tbody> <tr> <td>0...10</td> <td>Reserved</td> <td></td> </tr> <tr> <td>11</td> <td>Fan command</td> <td>1 = Drive fan is rotating above idle speed</td> </tr> <tr> <td>12</td> <td>Fan service counter</td> <td>1 = Drive fan service counter has reached its limit</td> </tr> <tr> <td>13...15</td> <td>Reserved</td> <td></td> </tr> </tbody> </table> |  |   |            | Bit | Name | Value | 0...10 | Reserved |  | 11 | Fan command | 1 = Drive fan is rotating above idle speed | 12 | Fan service counter | 1 = Drive fan service counter has reached its limit | 13...15 | Reserved |  |
| Bit  | Name                                     | Value   |            |     |      |       |        |          |  |    |             |  |    |                     |   |         |          |  |
| 0...10   | Reserved                                 |   |            |     |      |       |        |          |  |    |             |  |    |                     |   |         |          |  |
| 11   | Fan command                              | 1 = Drive fan is rotating above idle speed  |            |     |      |       |        |          |  |    |             |  |    |                     |   |         |          |  |
| 12   | Fan service counter                      | 1 = Drive fan service counter has reached its limit   |            |     |      |       |        |          |  |    |             |  |    |                     |   |         |          |  |
| 13...15  | Reserved                                 |   |            |     |      |       |        |          |  |    |             |  |    |                     |   |         |          |  |
|  | 0000h...FFFFh                            | Diagnostic word 3.  | 1 = 1      |     |      |       |        |          |  |    |             |  |    |                     |   |         |          |  |
| <a href="#">05.41</a>  | <a href="#">Main fan service counter</a> | Displays the age of the main cooling fan as a percentage of its estimated lifetime. The estimate is based on the duty, operating conditions and other operating parameters of the fan. When the counter reaches 100%, a warning ( <a href="#">A8C0 Fan service counter</a> ) is generated.<br>Can be reset from the control panel by keeping Reset depressed for over 3 seconds.              | -          |     |      |       |        |          |  |    |             |  |    |                     |   |         |          |  |
|  | 0...150%                                 | Main cooling fan age.   | 1 = 1%     |     |      |       |        |          |  |    |             |  |    |                     |   |         |          |  |

| No.                                | Name/Value                            | Description   | Def/FbEq16 |
|------------------------------------|---------------------------------------|---|------------|
| 05.42                              | <i>Aux. fan service counter</i>       | Displays the age of the auxiliary cooling fan as a percentage of its estimated lifetime. The estimate is based on the duty, operating conditions and other operating parameters of the fan. When the counter reaches 100%, a warning ( <i>A8C0 Fan service counter</i> ) is generated.<br>Can be reset from the control panel by keeping Reset depressed for over 3 seconds.  | -          |
|                                    | 0...150%                              | Auxiliary cooling fan age.  | 1 = 1%     |
| 05.111                             | <i>Line converter temperature</i>     | ( <i>Only visible when IGBT supply unit control activated by 95.20</i> )<br>Estimated supply unit temperature in percent of fault limit.<br>0.0% = 0 °C (32 °F)<br>94% approx. = Warning limit<br>100.0% = Fault limit  | -          |
|                                    | -40.0 ... 160.0%                      | Supply unit temperature in percent.   | 1 = 1%     |
| 05.121                             | <i>MCB closing counter</i>            | ( <i>Only visible when IGBT supply unit control activated by 95.20</i> )<br>Counts the closures of the main circuit breaker of the supply unit.   | -          |
|                                    | 0...4294967295                        | Count of closures of main circuit breaker.  | 1 = 1      |
| <b>06 Control and status words</b> |                                       | Drive control and status words.   |            |
| 06.01                              | <i>Main control word</i>              | The main control word of the drive. This parameter shows the control signals as received from the selected sources (such as digital inputs, the fieldbus interfaces and the application program).<br>The bit assignments of the word are as described on page 557. The related status word and state diagram are presented on pages 558 and 559 respectively.<br><b>Note:</b> Bits 12...15 can be used to carry additional control data, and used as a signal source by any binary-source selector parameter.<br>This parameter is read-only. | -          |
|                                    | 0000h...FFFFh                         | Main control word.  | 1 = 1      |
| 06.02                              | <i>Application control word</i>       | The drive control word received from the application program (if any). The bit assignments are described on page 557.<br>This parameter is read-only.   | -          |
|                                    | 0000h...FFFFh                         | Application program control word.   | 1 = 1      |
| 06.03                              | <i>FBA A transparent control word</i> | Displays the unaltered control word received from the PLC through fieldbus adapter A when a transparent communication profile is selected eg. by parameter group 51 <i>FBA A settings</i> . See section <i>Control word and Status word</i> (page 554).<br>This parameter is read-only.   | -          |
|                                    | 00000000h ... FFFFFFFFh               | Control word received through fieldbus adapter A.   | -          |



| No.   | Name/Value                            | Description  | Def/FbEq16 |
|-------|---------------------------------------|--|------------|
| 06.04 | <i>FBA B transparent control word</i> | Displays the unaltered control word received from the PLC through fieldbus adapter B when a transparent communication profile is selected eg. by parameter group <a href="#">54 FBA B settings</a> . See section <a href="#">Control word and Status word</a> (page <a href="#">554</a> ).<br>This parameter is read-only.   | -          |
|       | 00000000h ...<br>FFFFFFFFh            | Control word received through fieldbus adapter B.  | 1 = 1      |
| 06.05 | <i>EFB transparent control word</i>   | Displays the unaltered control word received from the PLC through the embedded fieldbus interface when a transparent communication profile is selected in parameter <a href="#">58.25 Control profile</a> . See section <a href="#">The Transparent profile</a> (page <a href="#">544</a> ).<br>This parameter is read-only. | -          |
|       | 00000000h ...<br>FFFFFFFFh            | Control word received through the embedded fieldbus interface.   | 1 = 1      |
| 06.11 | <i>Main status word</i>               | Main status word of the drive.<br>The bit assignments are described on page <a href="#">558</a> . The related control word and state diagram are presented on pages <a href="#">557</a> and <a href="#">559</a> respectively.<br>This parameter is read-only.  | -          |
|       | 0000h...FFFFh                         | Main status word.  | 1 = 1      |

| No.     | Name/Value          | Description   | Def/FbEq16 |      |             |   |         |  |   |           |  |   |            |  |   |                |   |   |                     |  |   |         |                            |   |            |  |   |          |   |   |               |                               |   |              |  |    |             |                                  |    |             |                                  |    |          |  |    |               |                     |         |          |  |  |
|---------|---------------------|---|------------|------|-------------|---|---------|--|---|-----------|--|---|------------|--|---|----------------|---|---|---------------------|--|---|---------|----------------------------|---|------------|--|---|----------|---|---|---------------|-------------------------------|---|--------------|--|----|-------------|----------------------------------|----|-------------|----------------------------------|----|----------|--|----|---------------|---------------------|---------|----------|--|--|
| 06.16   | Drive status word 1 | Drive status word 1.<br>This parameter is read-only.  | -          |      |             |   |         |  |   |           |  |   |            |  |   |                |   |   |                     |  |   |         |                            |   |            |  |   |          |   |   |               |                               |   |              |  |    |             |                                  |    |             |                                  |    |          |  |    |               |                     |         |          |  |  |
|         |                     | <table border="1"> <thead> <tr> <th>Bit</th> <th>Name</th> <th>Description</th> </tr> </thead> <tbody> <tr> <td>0</td> <td>Enabled</td> <td>1 = Both run enable (see par. 20.12) and start enable (20.19) signals are present, and Safe torque off has not been activated.<br/><b>Notes:</b> <ul style="list-style-type: none"> <li>In I/O or local control, clearing this bit makes the drive enter the SWITCH-ON INHIBITED state (see page 558).</li> <li>This bit is not affected by the presence of a fault.</li> </ul> </td> </tr> <tr> <td>1</td> <td>Inhibited</td> <td>1 = Start inhibited. See parameters 06.18 and 06.25 for the source of the inhibiting signal.</td> </tr> <tr> <td>2</td> <td>DC charged</td> <td>1 = DC circuit has been charged. If present, the DC switch is closed, and charging switch is open.<br/>0 = Charging not complete. If the inverter unit is not equipped with a DC switch (option +F286), check setting of 95.09.</td> </tr> <tr> <td>3</td> <td>Ready to start</td> <td>1 = Drive is ready to receive a start command</td> </tr> <tr> <td>4</td> <td>Following reference</td> <td>1 = Drive is ready to follow given reference</td> </tr> <tr> <td>5</td> <td>Started</td> <td>1 = Drive has been started</td> </tr> <tr> <td>6</td> <td>Modulating</td> <td>1 = Drive is modulating (output stage is being controlled)</td> </tr> <tr> <td>7</td> <td>Limiting</td> <td>1 = Any operating limit (speed, torque, etc.) is active</td> </tr> <tr> <td>8</td> <td>Local control</td> <td>1 = Drive is in local control</td> </tr> <tr> <td>9</td> <td>Network ctrl</td> <td>1 = Drive is in <i>network control</i> (see page 14)</td> </tr> <tr> <td>10</td> <td>Ext1 active</td> <td>1 = Control location EXT1 active</td> </tr> <tr> <td>11</td> <td>Ext2 active</td> <td>1 = Control location EXT2 active</td> </tr> <tr> <td>12</td> <td>Reserved</td> <td></td> </tr> <tr> <td>13</td> <td>Start request</td> <td>1 = Start requested</td> </tr> <tr> <td>14...15</td> <td>Reserved</td> <td></td> </tr> </tbody> </table> | Bit        | Name | Description | 0 | Enabled | 1 = Both run enable (see par. 20.12) and start enable (20.19) signals are present, and Safe torque off has not been activated.<br><b>Notes:</b> <ul style="list-style-type: none"> <li>In I/O or local control, clearing this bit makes the drive enter the SWITCH-ON INHIBITED state (see page 558).</li> <li>This bit is not affected by the presence of a fault.</li> </ul> | 1 | Inhibited | 1 = Start inhibited. See parameters 06.18 and 06.25 for the source of the inhibiting signal. | 2 | DC charged | 1 = DC circuit has been charged. If present, the DC switch is closed, and charging switch is open.<br>0 = Charging not complete. If the inverter unit is not equipped with a DC switch (option +F286), check setting of 95.09. | 3 | Ready to start | 1 = Drive is ready to receive a start command | 4 | Following reference | 1 = Drive is ready to follow given reference | 5 | Started | 1 = Drive has been started | 6 | Modulating | 1 = Drive is modulating (output stage is being controlled) | 7 | Limiting | 1 = Any operating limit (speed, torque, etc.) is active | 8 | Local control | 1 = Drive is in local control | 9 | Network ctrl | 1 = Drive is in <i>network control</i> (see page 14) | 10 | Ext1 active | 1 = Control location EXT1 active | 11 | Ext2 active | 1 = Control location EXT2 active | 12 | Reserved |  | 13 | Start request | 1 = Start requested | 14...15 | Reserved |  |  |
| Bit     | Name                | Description   |            |      |             |   |         |  |   |           |  |   |            |  |   |                |   |   |                     |  |   |         |                            |   |            |  |   |          |   |   |               |                               |   |              |  |    |             |                                  |    |             |                                  |    |          |  |    |               |                     |         |          |  |  |
| 0       | Enabled             | 1 = Both run enable (see par. 20.12) and start enable (20.19) signals are present, and Safe torque off has not been activated.<br><b>Notes:</b> <ul style="list-style-type: none"> <li>In I/O or local control, clearing this bit makes the drive enter the SWITCH-ON INHIBITED state (see page 558).</li> <li>This bit is not affected by the presence of a fault.</li> </ul>  |            |      |             |   |         |  |   |           |  |   |            |  |   |                |   |   |                     |  |   |         |                            |   |            |  |   |          |   |   |               |                               |   |              |  |    |             |                                  |    |             |                                  |    |          |  |    |               |                     |         |          |  |  |
| 1       | Inhibited           | 1 = Start inhibited. See parameters 06.18 and 06.25 for the source of the inhibiting signal.  |            |      |             |   |         |  |   |           |  |   |            |  |   |                |   |   |                     |  |   |         |                            |   |            |  |   |          |   |   |               |                               |   |              |  |    |             |                                  |    |             |                                  |    |          |  |    |               |                     |         |          |  |  |
| 2       | DC charged          | 1 = DC circuit has been charged. If present, the DC switch is closed, and charging switch is open.<br>0 = Charging not complete. If the inverter unit is not equipped with a DC switch (option +F286), check setting of 95.09.  |            |      |             |   |         |  |   |           |  |   |            |  |   |                |   |   |                     |  |   |         |                            |   |            |  |   |          |   |   |               |                               |   |              |  |    |             |                                  |    |             |                                  |    |          |  |    |               |                     |         |          |  |  |
| 3       | Ready to start      | 1 = Drive is ready to receive a start command   |            |      |             |   |         |  |   |           |  |   |            |  |   |                |   |   |                     |  |   |         |                            |   |            |  |   |          |   |   |               |                               |   |              |  |    |             |                                  |    |             |                                  |    |          |  |    |               |                     |         |          |  |  |
| 4       | Following reference | 1 = Drive is ready to follow given reference  |            |      |             |   |         |  |   |           |  |   |            |  |   |                |   |   |                     |  |   |         |                            |   |            |  |   |          |   |   |               |                               |   |              |  |    |             |                                  |    |             |                                  |    |          |  |    |               |                     |         |          |  |  |
| 5       | Started             | 1 = Drive has been started  |            |      |             |   |         |  |   |           |  |   |            |  |   |                |   |   |                     |  |   |         |                            |   |            |  |   |          |   |   |               |                               |   |              |  |    |             |                                  |    |             |                                  |    |          |  |    |               |                     |         |          |  |  |
| 6       | Modulating          | 1 = Drive is modulating (output stage is being controlled)  |            |      |             |   |         |  |   |           |  |   |            |  |   |                |   |   |                     |  |   |         |                            |   |            |  |   |          |   |   |               |                               |   |              |  |    |             |                                  |    |             |                                  |    |          |  |    |               |                     |         |          |  |  |
| 7       | Limiting            | 1 = Any operating limit (speed, torque, etc.) is active   |            |      |             |   |         |  |   |           |  |   |            |  |   |                |   |   |                     |  |   |         |                            |   |            |  |   |          |   |   |               |                               |   |              |  |    |             |                                  |    |             |                                  |    |          |  |    |               |                     |         |          |  |  |
| 8       | Local control       | 1 = Drive is in local control   |            |      |             |   |         |  |   |           |  |   |            |  |   |                |   |   |                     |  |   |         |                            |   |            |  |   |          |   |   |               |                               |   |              |  |    |             |                                  |    |             |                                  |    |          |  |    |               |                     |         |          |  |  |
| 9       | Network ctrl        | 1 = Drive is in <i>network control</i> (see page 14)  |            |      |             |   |         |  |   |           |  |   |            |  |   |                |   |   |                     |  |   |         |                            |   |            |  |   |          |   |   |               |                               |   |              |  |    |             |                                  |    |             |                                  |    |          |  |    |               |                     |         |          |  |  |
| 10      | Ext1 active         | 1 = Control location EXT1 active  |            |      |             |   |         |  |   |           |  |   |            |  |   |                |   |   |                     |  |   |         |                            |   |            |  |   |          |   |   |               |                               |   |              |  |    |             |                                  |    |             |                                  |    |          |  |    |               |                     |         |          |  |  |
| 11      | Ext2 active         | 1 = Control location EXT2 active  |            |      |             |   |         |  |   |           |  |   |            |  |   |                |   |   |                     |  |   |         |                            |   |            |  |   |          |   |   |               |                               |   |              |  |    |             |                                  |    |             |                                  |    |          |  |    |               |                     |         |          |  |  |
| 12      | Reserved            |   |            |      |             |   |         |  |   |           |  |   |            |  |   |                |   |   |                     |  |   |         |                            |   |            |  |   |          |   |   |               |                               |   |              |  |    |             |                                  |    |             |                                  |    |          |  |    |               |                     |         |          |  |  |
| 13      | Start request       | 1 = Start requested   |            |      |             |   |         |  |   |           |  |   |            |  |   |                |   |   |                     |  |   |         |                            |   |            |  |   |          |   |   |               |                               |   |              |  |    |             |                                  |    |             |                                  |    |          |  |    |               |                     |         |          |  |  |
| 14...15 | Reserved            |   |            |      |             |   |         |  |   |           |  |   |            |  |   |                |   |   |                     |  |   |         |                            |   |            |  |   |          |   |   |               |                               |   |              |  |    |             |                                  |    |             |                                  |    |          |  |    |               |                     |         |          |  |  |
|         | 0000h...FFFFh       | Drive status word 1.  | 1 = 1      |      |             |   |         |  |   |           |  |   |            |  |   |                |   |   |                     |  |   |         |                            |   |            |  |   |          |   |   |               |                               |   |              |  |    |             |                                  |    |             |                                  |    |          |  |    |               |                     |         |          |  |  |

| No.   | Name/Value                          | Description   | Def/FbEq16 |      |             |   |                         |  |   |            |                                   |   |                |                                |   |               |                               |   |               |           |   |                       |   |   |                   |   |   |                   |                           |   |                       |   |   |                |                                 |    |             |   |    |                       |   |    |             |   |    |          |  |    |             |   |    |          |  |  |
|-------|-------------------------------------|---|------------|------|-------------|---|-------------------------|--|---|------------|-----------------------------------|---|----------------|--------------------------------|---|---------------|-------------------------------|---|---------------|-----------|---|-----------------------|---|---|-------------------|---|---|-------------------|---------------------------|---|-----------------------|---|---|----------------|---------------------------------|----|-------------|---|----|-----------------------|---|----|-------------|---|----|----------|--|----|-------------|---|----|----------|--|--|
| 06.17 | <a href="#">Drive status word 2</a> | Drive status word 2.<br>This parameter is read-only.  | -          |      |             |   |                         |  |   |            |                                   |   |                |                                |   |               |                               |   |               |           |   |                       |   |   |                   |   |   |                   |                           |   |                       |   |   |                |                                 |    |             |   |    |                       |   |    |             |   |    |          |  |    |             |   |    |          |  |  |
|       |                                     | <table border="1"> <thead> <tr> <th>Bit</th> <th>Name</th> <th>Description</th> </tr> </thead> <tbody> <tr> <td>0</td> <td>Identification run done</td> <td>1 = Motor identification (ID) run has been performed</td> </tr> <tr> <td>1</td> <td>Magnetized</td> <td>1 = The motor has been magnetized</td> </tr> <tr> <td>2</td> <td>Torque control</td> <td>1 = Torque control mode active</td> </tr> <tr> <td>3</td> <td>Speed control</td> <td>1 = Speed control mode active</td> </tr> <tr> <td>4</td> <td>Power control</td> <td>Reserved.</td> </tr> <tr> <td>5</td> <td>Safe reference active</td> <td>1 = A "safe" reference is being applied by functions such as parameters <a href="#">49.05</a> and <a href="#">50.02</a></td> </tr> <tr> <td>6</td> <td>Last speed active</td> <td>1 = A "last speed" reference is being applied by functions such as parameters <a href="#">49.05</a> and <a href="#">50.02</a></td> </tr> <tr> <td>7</td> <td>Loss of reference</td> <td>1 = Reference signal lost</td> </tr> <tr> <td>8</td> <td>Emergency stop failed</td> <td>1 = Emergency stop failed (see parameters <a href="#">31.32</a> and <a href="#">31.33</a>)</td> </tr> <tr> <td>9</td> <td>Jogging active</td> <td>1 = Jogging enable signal is on</td> </tr> <tr> <td>10</td> <td>Above limit</td> <td>1 = Actual speed, frequency or torque equals or exceeds limit (defined by parameters <a href="#">46.31</a>...<a href="#">46.33</a>). Valid in both directions of rotation.</td> </tr> <tr> <td>11</td> <td>Emergency stop active</td> <td>1 = An emergency stop command signal is active, or the drive is stopping after receiving an emergency stop command.</td> </tr> <tr> <td>12</td> <td>Reduced run</td> <td>1 = Reduced run active (see section <a href="#">Reduced run function</a> on page <a href="#">92</a>)</td> </tr> <tr> <td>13</td> <td>Reserved</td> <td></td> </tr> <tr> <td>14</td> <td>Stop failed</td> <td>1 = Stopping failed (see parameters <a href="#">31.37</a> and <a href="#">31.38</a>)</td> </tr> <tr> <td>15</td> <td>Reserved</td> <td></td> </tr> </tbody> </table> | Bit        | Name | Description | 0 | Identification run done | 1 = Motor identification (ID) run has been performed | 1 | Magnetized | 1 = The motor has been magnetized | 2 | Torque control | 1 = Torque control mode active | 3 | Speed control | 1 = Speed control mode active | 4 | Power control | Reserved. | 5 | Safe reference active | 1 = A "safe" reference is being applied by functions such as parameters <a href="#">49.05</a> and <a href="#">50.02</a> | 6 | Last speed active | 1 = A "last speed" reference is being applied by functions such as parameters <a href="#">49.05</a> and <a href="#">50.02</a> | 7 | Loss of reference | 1 = Reference signal lost | 8 | Emergency stop failed | 1 = Emergency stop failed (see parameters <a href="#">31.32</a> and <a href="#">31.33</a> ) | 9 | Jogging active | 1 = Jogging enable signal is on | 10 | Above limit | 1 = Actual speed, frequency or torque equals or exceeds limit (defined by parameters <a href="#">46.31</a> ... <a href="#">46.33</a> ). Valid in both directions of rotation. | 11 | Emergency stop active | 1 = An emergency stop command signal is active, or the drive is stopping after receiving an emergency stop command. | 12 | Reduced run | 1 = Reduced run active (see section <a href="#">Reduced run function</a> on page <a href="#">92</a> ) | 13 | Reserved |  | 14 | Stop failed | 1 = Stopping failed (see parameters <a href="#">31.37</a> and <a href="#">31.38</a> ) | 15 | Reserved |  |  |
| Bit   | Name                                | Description   |            |      |             |   |                         |  |   |            |                                   |   |                |                                |   |               |                               |   |               |           |   |                       |   |   |                   |   |   |                   |                           |   |                       |   |   |                |                                 |    |             |   |    |                       |   |    |             |   |    |          |  |    |             |   |    |          |  |  |
| 0     | Identification run done             | 1 = Motor identification (ID) run has been performed  |            |      |             |   |                         |  |   |            |                                   |   |                |                                |   |               |                               |   |               |           |   |                       |   |   |                   |   |   |                   |                           |   |                       |   |   |                |                                 |    |             |   |    |                       |   |    |             |   |    |          |  |    |             |   |    |          |  |  |
| 1     | Magnetized                          | 1 = The motor has been magnetized   |            |      |             |   |                         |  |   |            |                                   |   |                |                                |   |               |                               |   |               |           |   |                       |   |   |                   |   |   |                   |                           |   |                       |   |   |                |                                 |    |             |   |    |                       |   |    |             |   |    |          |  |    |             |   |    |          |  |  |
| 2     | Torque control                      | 1 = Torque control mode active  |            |      |             |   |                         |  |   |            |                                   |   |                |                                |   |               |                               |   |               |           |   |                       |   |   |                   |   |   |                   |                           |   |                       |   |   |                |                                 |    |             |   |    |                       |   |    |             |   |    |          |  |    |             |   |    |          |  |  |
| 3     | Speed control                       | 1 = Speed control mode active   |            |      |             |   |                         |  |   |            |                                   |   |                |                                |   |               |                               |   |               |           |   |                       |   |   |                   |   |   |                   |                           |   |                       |   |   |                |                                 |    |             |   |    |                       |   |    |             |   |    |          |  |    |             |   |    |          |  |  |
| 4     | Power control                       | Reserved.   |            |      |             |   |                         |  |   |            |                                   |   |                |                                |   |               |                               |   |               |           |   |                       |   |   |                   |   |   |                   |                           |   |                       |   |   |                |                                 |    |             |   |    |                       |   |    |             |   |    |          |  |    |             |   |    |          |  |  |
| 5     | Safe reference active               | 1 = A "safe" reference is being applied by functions such as parameters <a href="#">49.05</a> and <a href="#">50.02</a>   |            |      |             |   |                         |  |   |            |                                   |   |                |                                |   |               |                               |   |               |           |   |                       |   |   |                   |   |   |                   |                           |   |                       |   |   |                |                                 |    |             |   |    |                       |   |    |             |   |    |          |  |    |             |   |    |          |  |  |
| 6     | Last speed active                   | 1 = A "last speed" reference is being applied by functions such as parameters <a href="#">49.05</a> and <a href="#">50.02</a>   |            |      |             |   |                         |  |   |            |                                   |   |                |                                |   |               |                               |   |               |           |   |                       |   |   |                   |   |   |                   |                           |   |                       |   |   |                |                                 |    |             |   |    |                       |   |    |             |   |    |          |  |    |             |   |    |          |  |  |
| 7     | Loss of reference                   | 1 = Reference signal lost   |            |      |             |   |                         |  |   |            |                                   |   |                |                                |   |               |                               |   |               |           |   |                       |   |   |                   |   |   |                   |                           |   |                       |   |   |                |                                 |    |             |   |    |                       |   |    |             |   |    |          |  |    |             |   |    |          |  |  |
| 8     | Emergency stop failed               | 1 = Emergency stop failed (see parameters <a href="#">31.32</a> and <a href="#">31.33</a> )   |            |      |             |   |                         |  |   |            |                                   |   |                |                                |   |               |                               |   |               |           |   |                       |   |   |                   |   |   |                   |                           |   |                       |   |   |                |                                 |    |             |   |    |                       |   |    |             |   |    |          |  |    |             |   |    |          |  |  |
| 9     | Jogging active                      | 1 = Jogging enable signal is on   |            |      |             |   |                         |  |   |            |                                   |   |                |                                |   |               |                               |   |               |           |   |                       |   |   |                   |   |   |                   |                           |   |                       |   |   |                |                                 |    |             |   |    |                       |   |    |             |   |    |          |  |    |             |   |    |          |  |  |
| 10    | Above limit                         | 1 = Actual speed, frequency or torque equals or exceeds limit (defined by parameters <a href="#">46.31</a> ... <a href="#">46.33</a> ). Valid in both directions of rotation.   |            |      |             |   |                         |  |   |            |                                   |   |                |                                |   |               |                               |   |               |           |   |                       |   |   |                   |   |   |                   |                           |   |                       |   |   |                |                                 |    |             |   |    |                       |   |    |             |   |    |          |  |    |             |   |    |          |  |  |
| 11    | Emergency stop active               | 1 = An emergency stop command signal is active, or the drive is stopping after receiving an emergency stop command.   |            |      |             |   |                         |  |   |            |                                   |   |                |                                |   |               |                               |   |               |           |   |                       |   |   |                   |   |   |                   |                           |   |                       |   |   |                |                                 |    |             |   |    |                       |   |    |             |   |    |          |  |    |             |   |    |          |  |  |
| 12    | Reduced run                         | 1 = Reduced run active (see section <a href="#">Reduced run function</a> on page <a href="#">92</a> )   |            |      |             |   |                         |  |   |            |                                   |   |                |                                |   |               |                               |   |               |           |   |                       |   |   |                   |   |   |                   |                           |   |                       |   |   |                |                                 |    |             |   |    |                       |   |    |             |   |    |          |  |    |             |   |    |          |  |  |
| 13    | Reserved                            |   |            |      |             |   |                         |  |   |            |                                   |   |                |                                |   |               |                               |   |               |           |   |                       |   |   |                   |   |   |                   |                           |   |                       |   |   |                |                                 |    |             |   |    |                       |   |    |             |   |    |          |  |    |             |   |    |          |  |  |
| 14    | Stop failed                         | 1 = Stopping failed (see parameters <a href="#">31.37</a> and <a href="#">31.38</a> )   |            |      |             |   |                         |  |   |            |                                   |   |                |                                |   |               |                               |   |               |           |   |                       |   |   |                   |   |   |                   |                           |   |                       |   |   |                |                                 |    |             |   |    |                       |   |    |             |   |    |          |  |    |             |   |    |          |  |  |
| 15    | Reserved                            |   |            |      |             |   |                         |  |   |            |                                   |   |                |                                |   |               |                               |   |               |           |   |                       |   |   |                   |   |   |                   |                           |   |                       |   |   |                |                                 |    |             |   |    |                       |   |    |             |   |    |          |  |    |             |   |    |          |  |  |
|       | 0000h...FFFFh                       | Drive status word 2.  | 1 = 1      |      |             |   |                         |  |   |            |                                   |   |                |                                |   |               |                               |   |               |           |   |                       |   |   |                   |   |   |                   |                           |   |                       |   |   |                |                                 |    |             |   |    |                       |   |    |             |   |    |          |  |    |             |   |    |          |  |  |

| No.  | Name/Value  | Description  | Def/FbEq16 |     |      |             |      |   |               |  |   |   |                       |                                  |     |   |             |  |   |   |             |                            |     |   |                   |                                 |   |   |                 |                               |   |   |             |   |   |   |     |                            |   |   |                           |  |     |   |              |   |     |    |                  |                                      |     |    |         |                                       |   |    |         |                                       |   |    |         |                                       |   |    |                    |  |  |    |                |   |   |
|--|---|--|------------|-----|------|-------------|------|---|---------------|--|---|---|-----------------------|----------------------------------|-----|---|-------------|--|---|---|-------------|----------------------------|-----|---|-------------------|---------------------------------|---|---|-----------------|-------------------------------|---|---|-------------|---|---|---|-----|----------------------------|---|---|---------------------------|--|-----|---|--------------|---|-----|----|------------------|--------------------------------------|-----|----|---------|---------------------------------------|---|----|---------|---------------------------------------|---|----|---------|---------------------------------------|---|----|--------------------|--|--|----|----------------|---|---|
| 06.18  | <i>Start inhibit status word</i>  | Start inhibit status word. This word specifies the source of the inhibiting condition that is preventing the drive from starting. After the condition is removed, the start command must be cycled. See bit-specific notes.<br>See also parameter <i>06.25 Drive inhibit status word 2</i> , and <i>06.16 Drive status word 1</i> , bit 1.<br>This parameter is read-only. | -          |     |      |             |      |   |               |  |   |   |                       |                                  |     |   |             |  |   |   |             |                            |     |   |                   |                                 |   |   |                 |                               |   |   |             |   |   |   |     |                            |   |   |                           |  |     |   |              |   |     |    |                  |                                      |     |    |         |                                       |   |    |         |                                       |   |    |         |                                       |   |    |                    |  |  |    |                |   |   |
| <table border="1"> <thead> <tr> <th>Bit</th> <th>Name</th> <th>Description</th> <th>Note</th> </tr> </thead> <tbody> <tr> <td>0</td> <td>Not ready run</td> <td>1 = DC voltage is missing or drive has not been parametrized correctly. Check the parameters in groups <a href="#">95</a> and <a href="#">99</a>.</td> <td>a</td> </tr> <tr> <td>1</td> <td>Ctrl location changed</td> <td>1 = Control location has changed</td> <td>a,c</td> </tr> <tr> <td>2</td> <td>SSW inhibit</td> <td>1 = Control program is keeping itself in inhibited state</td> <td>a</td> </tr> <tr> <td>3</td> <td>Fault reset</td> <td>1 = A fault has been reset</td> <td>a,c</td> </tr> <tr> <td>4</td> <td>Lost start enable</td> <td>1 = Start enable signal missing</td> <td>a</td> </tr> <tr> <td>5</td> <td>Lost run enable</td> <td>1 = Run enable signal missing</td> <td>a</td> </tr> <tr> <td>6</td> <td>FSO inhibit</td> <td>1 = Operation prevented by FSO-xx safety functions module</td> <td>b</td> </tr> <tr> <td>7</td> <td>STO</td> <td>1 = Safe torque off active</td> <td>b</td> </tr> <tr> <td>8</td> <td>Current calibration ended</td> <td>1 = Current calibration routine has finished</td> <td>b,c</td> </tr> <tr> <td>9</td> <td>ID run ended</td> <td>1 = Motor identification run has finished</td> <td>b,c</td> </tr> <tr> <td>10</td> <td>Auto phase ended</td> <td>1 = Autophasing routine has finished</td> <td>b,c</td> </tr> <tr> <td>11</td> <td>Em Off1</td> <td>1 = Emergency stop signal (mode Off1)</td> <td>b</td> </tr> <tr> <td>12</td> <td>Em Off2</td> <td>1 = Emergency stop signal (mode Off2)</td> <td>b</td> </tr> <tr> <td>13</td> <td>Em Off3</td> <td>1 = Emergency stop signal (mode Off3)</td> <td>b</td> </tr> <tr> <td>14</td> <td>Auto reset inhibit</td> <td>1 = The autoreset function is inhibiting operation</td> <td></td> </tr> <tr> <td>15</td> <td>Jogging active</td> <td>1 = The jogging enable signal is inhibiting operation</td> <td>b</td> </tr> </tbody> </table> |   |  |            | Bit | Name | Description | Note | 0 | Not ready run | 1 = DC voltage is missing or drive has not been parametrized correctly. Check the parameters in groups <a href="#">95</a> and <a href="#">99</a> . | a | 1 | Ctrl location changed | 1 = Control location has changed | a,c | 2 | SSW inhibit | 1 = Control program is keeping itself in inhibited state | a | 3 | Fault reset | 1 = A fault has been reset | a,c | 4 | Lost start enable | 1 = Start enable signal missing | a | 5 | Lost run enable | 1 = Run enable signal missing | a | 6 | FSO inhibit | 1 = Operation prevented by FSO-xx safety functions module | b | 7 | STO | 1 = Safe torque off active | b | 8 | Current calibration ended | 1 = Current calibration routine has finished | b,c | 9 | ID run ended | 1 = Motor identification run has finished | b,c | 10 | Auto phase ended | 1 = Autophasing routine has finished | b,c | 11 | Em Off1 | 1 = Emergency stop signal (mode Off1) | b | 12 | Em Off2 | 1 = Emergency stop signal (mode Off2) | b | 13 | Em Off3 | 1 = Emergency stop signal (mode Off3) | b | 14 | Auto reset inhibit | 1 = The autoreset function is inhibiting operation |  | 15 | Jogging active | 1 = The jogging enable signal is inhibiting operation | b |
| Bit  | Name  | Description  | Note       |     |      |             |      |   |               |  |   |   |                       |                                  |     |   |             |  |   |   |             |                            |     |   |                   |                                 |   |   |                 |                               |   |   |             |   |   |   |     |                            |   |   |                           |  |     |   |              |   |     |    |                  |                                      |     |    |         |                                       |   |    |         |                                       |   |    |         |                                       |   |    |                    |  |  |    |                |   |   |
| 0  | Not ready run   | 1 = DC voltage is missing or drive has not been parametrized correctly. Check the parameters in groups <a href="#">95</a> and <a href="#">99</a> .   | a          |     |      |             |      |   |               |  |   |   |                       |                                  |     |   |             |  |   |   |             |                            |     |   |                   |                                 |   |   |                 |                               |   |   |             |   |   |   |     |                            |   |   |                           |  |     |   |              |   |     |    |                  |                                      |     |    |         |                                       |   |    |         |                                       |   |    |         |                                       |   |    |                    |  |  |    |                |   |   |
| 1  | Ctrl location changed   | 1 = Control location has changed   | a,c        |     |      |             |      |   |               |  |   |   |                       |                                  |     |   |             |  |   |   |             |                            |     |   |                   |                                 |   |   |                 |                               |   |   |             |   |   |   |     |                            |   |   |                           |  |     |   |              |   |     |    |                  |                                      |     |    |         |                                       |   |    |         |                                       |   |    |         |                                       |   |    |                    |  |  |    |                |   |   |
| 2  | SSW inhibit   | 1 = Control program is keeping itself in inhibited state   | a          |     |      |             |      |   |               |  |   |   |                       |                                  |     |   |             |  |   |   |             |                            |     |   |                   |                                 |   |   |                 |                               |   |   |             |   |   |   |     |                            |   |   |                           |  |     |   |              |   |     |    |                  |                                      |     |    |         |                                       |   |    |         |                                       |   |    |         |                                       |   |    |                    |  |  |    |                |   |   |
| 3  | Fault reset   | 1 = A fault has been reset   | a,c        |     |      |             |      |   |               |  |   |   |                       |                                  |     |   |             |  |   |   |             |                            |     |   |                   |                                 |   |   |                 |                               |   |   |             |   |   |   |     |                            |   |   |                           |  |     |   |              |   |     |    |                  |                                      |     |    |         |                                       |   |    |         |                                       |   |    |         |                                       |   |    |                    |  |  |    |                |   |   |
| 4  | Lost start enable   | 1 = Start enable signal missing  | a          |     |      |             |      |   |               |  |   |   |                       |                                  |     |   |             |  |   |   |             |                            |     |   |                   |                                 |   |   |                 |                               |   |   |             |   |   |   |     |                            |   |   |                           |  |     |   |              |   |     |    |                  |                                      |     |    |         |                                       |   |    |         |                                       |   |    |         |                                       |   |    |                    |  |  |    |                |   |   |
| 5  | Lost run enable   | 1 = Run enable signal missing  | a          |     |      |             |      |   |               |  |   |   |                       |                                  |     |   |             |  |   |   |             |                            |     |   |                   |                                 |   |   |                 |                               |   |   |             |   |   |   |     |                            |   |   |                           |  |     |   |              |   |     |    |                  |                                      |     |    |         |                                       |   |    |         |                                       |   |    |         |                                       |   |    |                    |  |  |    |                |   |   |
| 6  | FSO inhibit   | 1 = Operation prevented by FSO-xx safety functions module  | b          |     |      |             |      |   |               |  |   |   |                       |                                  |     |   |             |  |   |   |             |                            |     |   |                   |                                 |   |   |                 |                               |   |   |             |   |   |   |     |                            |   |   |                           |  |     |   |              |   |     |    |                  |                                      |     |    |         |                                       |   |    |         |                                       |   |    |         |                                       |   |    |                    |  |  |    |                |   |   |
| 7  | STO   | 1 = Safe torque off active   | b          |     |      |             |      |   |               |  |   |   |                       |                                  |     |   |             |  |   |   |             |                            |     |   |                   |                                 |   |   |                 |                               |   |   |             |   |   |   |     |                            |   |   |                           |  |     |   |              |   |     |    |                  |                                      |     |    |         |                                       |   |    |         |                                       |   |    |         |                                       |   |    |                    |  |  |    |                |   |   |
| 8  | Current calibration ended   | 1 = Current calibration routine has finished   | b,c        |     |      |             |      |   |               |  |   |   |                       |                                  |     |   |             |  |   |   |             |                            |     |   |                   |                                 |   |   |                 |                               |   |   |             |   |   |   |     |                            |   |   |                           |  |     |   |              |   |     |    |                  |                                      |     |    |         |                                       |   |    |         |                                       |   |    |         |                                       |   |    |                    |  |  |    |                |   |   |
| 9  | ID run ended  | 1 = Motor identification run has finished  | b,c        |     |      |             |      |   |               |  |   |   |                       |                                  |     |   |             |  |   |   |             |                            |     |   |                   |                                 |   |   |                 |                               |   |   |             |   |   |   |     |                            |   |   |                           |  |     |   |              |   |     |    |                  |                                      |     |    |         |                                       |   |    |         |                                       |   |    |         |                                       |   |    |                    |  |  |    |                |   |   |
| 10   | Auto phase ended  | 1 = Autophasing routine has finished   | b,c        |     |      |             |      |   |               |  |   |   |                       |                                  |     |   |             |  |   |   |             |                            |     |   |                   |                                 |   |   |                 |                               |   |   |             |   |   |   |     |                            |   |   |                           |  |     |   |              |   |     |    |                  |                                      |     |    |         |                                       |   |    |         |                                       |   |    |         |                                       |   |    |                    |  |  |    |                |   |   |
| 11   | Em Off1   | 1 = Emergency stop signal (mode Off1)  | b          |     |      |             |      |   |               |  |   |   |                       |                                  |     |   |             |  |   |   |             |                            |     |   |                   |                                 |   |   |                 |                               |   |   |             |   |   |   |     |                            |   |   |                           |  |     |   |              |   |     |    |                  |                                      |     |    |         |                                       |   |    |         |                                       |   |    |         |                                       |   |    |                    |  |  |    |                |   |   |
| 12   | Em Off2   | 1 = Emergency stop signal (mode Off2)  | b          |     |      |             |      |   |               |  |   |   |                       |                                  |     |   |             |  |   |   |             |                            |     |   |                   |                                 |   |   |                 |                               |   |   |             |   |   |   |     |                            |   |   |                           |  |     |   |              |   |     |    |                  |                                      |     |    |         |                                       |   |    |         |                                       |   |    |         |                                       |   |    |                    |  |  |    |                |   |   |
| 13   | Em Off3   | 1 = Emergency stop signal (mode Off3)  | b          |     |      |             |      |   |               |  |   |   |                       |                                  |     |   |             |  |   |   |             |                            |     |   |                   |                                 |   |   |                 |                               |   |   |             |   |   |   |     |                            |   |   |                           |  |     |   |              |   |     |    |                  |                                      |     |    |         |                                       |   |    |         |                                       |   |    |         |                                       |   |    |                    |  |  |    |                |   |   |
| 14   | Auto reset inhibit  | 1 = The autoreset function is inhibiting operation   |            |     |      |             |      |   |               |  |   |   |                       |                                  |     |   |             |  |   |   |             |                            |     |   |                   |                                 |   |   |                 |                               |   |   |             |   |   |   |     |                            |   |   |                           |  |     |   |              |   |     |    |                  |                                      |     |    |         |                                       |   |    |         |                                       |   |    |         |                                       |   |    |                    |  |  |    |                |   |   |
| 15   | Jogging active  | 1 = The jogging enable signal is inhibiting operation  | b          |     |      |             |      |   |               |  |   |   |                       |                                  |     |   |             |  |   |   |             |                            |     |   |                   |                                 |   |   |                 |                               |   |   |             |   |   |   |     |                            |   |   |                           |  |     |   |              |   |     |    |                  |                                      |     |    |         |                                       |   |    |         |                                       |   |    |         |                                       |   |    |                    |  |  |    |                |   |   |
| <b>Notes:</b>  |   |  |            |     |      |             |      |   |               |  |   |   |                       |                                  |     |   |             |  |   |   |             |                            |     |   |                   |                                 |   |   |                 |                               |   |   |             |   |   |   |     |                            |   |   |                           |  |     |   |              |   |     |    |                  |                                      |     |    |         |                                       |   |    |         |                                       |   |    |         |                                       |   |    |                    |  |  |    |                |   |   |
| a  | If bit 1 of <i>06.16 Drive status word 1</i> is still set after the removal of the inhibiting condition, and edge triggering is selected for the active external control location, a fresh rising-edge start signal is required. See parameters <a href="#">20.02</a> , <a href="#">20.07</a> and <a href="#">20.19</a> . |  |            |     |      |             |      |   |               |  |   |   |                       |                                  |     |   |             |  |   |   |             |                            |     |   |                   |                                 |   |   |                 |                               |   |   |             |   |   |   |     |                            |   |   |                           |  |     |   |              |   |     |    |                  |                                      |     |    |         |                                       |   |    |         |                                       |   |    |         |                                       |   |    |                    |  |  |    |                |   |   |
| b  | If bit 1 of <i>06.16 Drive status word 1</i> is still set after the removal of the inhibiting condition, a fresh rising-edge start signal is required.  |  |            |     |      |             |      |   |               |  |   |   |                       |                                  |     |   |             |  |   |   |             |                            |     |   |                   |                                 |   |   |                 |                               |   |   |             |   |   |   |     |                            |   |   |                           |  |     |   |              |   |     |    |                  |                                      |     |    |         |                                       |   |    |         |                                       |   |    |         |                                       |   |    |                    |  |  |    |                |   |   |
| c  | Informative bit. The inhibiting condition need not be removed by the user.  |  |            |     |      |             |      |   |               |  |   |   |                       |                                  |     |   |             |  |   |   |             |                            |     |   |                   |                                 |   |   |                 |                               |   |   |             |   |   |   |     |                            |   |   |                           |  |     |   |              |   |     |    |                  |                                      |     |    |         |                                       |   |    |         |                                       |   |    |         |                                       |   |    |                    |  |  |    |                |   |   |
| 0000h...FFFFh  | Start inhibit status word.  |  | 1 = 1      |     |      |             |      |   |               |  |   |   |                       |                                  |     |   |             |  |   |   |             |                            |     |   |                   |                                 |   |   |                 |                               |   |   |             |   |   |   |     |                            |   |   |                           |  |     |   |              |   |     |    |                  |                                      |     |    |         |                                       |   |    |         |                                       |   |    |         |                                       |   |    |                    |  |  |    |                |   |   |

| No.     | Name/Value                       | Description  | Def/FbEq16 |      |             |   |            |  |   |         |  |   |         |  |   |               |   |   |                         |  |   |                    |   |   |                    |   |   |                            |   |   |                             |  |   |                             |  |         |          |  |  |
|---------|----------------------------------|--|------------|------|-------------|---|------------|--|---|---------|--|---|---------|--|---|---------------|---|---|-------------------------|--|---|--------------------|---|---|--------------------|---|---|----------------------------|---|---|-----------------------------|--|---|-----------------------------|--|---------|----------|--|--|
| 06.19   | <i>Speed control status word</i> | Speed control status word.<br>This parameter is read-only.   | -          |      |             |   |            |  |   |         |  |   |         |  |   |               |   |   |                         |  |   |                    |   |   |                    |   |   |                            |   |   |                             |  |   |                             |  |         |          |  |  |
|         |                                  | <table border="1"> <thead> <tr> <th>Bit</th> <th>Name</th> <th>Description</th> </tr> </thead> <tbody> <tr> <td>0</td> <td>Zero speed</td> <td>1 = Drive is running at zero speed, ie. the absolute value of par. <a href="#">90.01 Motor speed for control</a> has remained below <a href="#">21.06 Zero speed limit</a> for longer than <a href="#">21.07 Zero speed delay</a>.<br/><b>Notes:</b> <ul style="list-style-type: none"> <li>This bit is not updated when mechanical brake control is enabled by par. <a href="#">44.06</a> and the drive is modulating.</li> <li>During a ramp stop when the drive is running forward, the delay count runs whenever <math>[90.01] &lt; [21.06]</math>. From the reverse direction, the delay count runs whenever <math>90.01 &gt; -[21.06]</math>.</li> </ul> </td> </tr> <tr> <td>1</td> <td>Forward</td> <td>1 = Drive is running in forward direction above zero speed limit, ie. <math>[90.01] &gt; +[21.06]</math>.</td> </tr> <tr> <td>2</td> <td>Reverse</td> <td>1 = Drive is running in reverse direction above zero speed limit, ie. <math>[90.01] &lt; -[21.06]</math>.</td> </tr> <tr> <td>3</td> <td>Out of window</td> <td>1 = Speed error window control active (see par. <a href="#">24.41</a>)</td> </tr> <tr> <td>4</td> <td>Internal speed feedback</td> <td>1 = Estimated speed feedback used in motor control, ie. estimated speed is selected by par. <a href="#">90.41</a> or <a href="#">90.46</a>, or selected encoder has faulted (par. <a href="#">90.45</a>)<br/>0 = Encoder 1 or 2 used for speed feedback</td> </tr> <tr> <td>5</td> <td>Encoder 1 feedback</td> <td>1 = Encoder 1 used for speed feedback in motor control<br/>0 = Encoder 1 faulted or not selected as source of speed feedback (see par. <a href="#">90.41</a> and <a href="#">90.46</a>)</td> </tr> <tr> <td>6</td> <td>Encoder 2 feedback</td> <td>1 = Encoder 2 used for speed feedback in motor control<br/>0 = Encoder 2 faulted or not selected as source of speed feedback (see par. <a href="#">90.41</a> and <a href="#">90.46</a>)</td> </tr> <tr> <td>7</td> <td>Any constant speed request</td> <td>1 = A constant speed or frequency has been selected; see par. <a href="#">06.20</a>.</td> </tr> <tr> <td>8</td> <td>Follower speed corr min lim</td> <td>1 = Minimum limit of speed correction (in a speed-controlled follower) has been reached (see par. <a href="#">23.39...23.41</a>).</td> </tr> <tr> <td>9</td> <td>Follower speed corr max lim</td> <td>1 = Maximum limit of speed correction (in a speed-controlled follower) has been reached (see par. <a href="#">23.39...23.41</a>).</td> </tr> <tr> <td>10...15</td> <td>Reserved</td> <td></td> </tr> </tbody> </table> | Bit        | Name | Description | 0 | Zero speed | 1 = Drive is running at zero speed, ie. the absolute value of par. <a href="#">90.01 Motor speed for control</a> has remained below <a href="#">21.06 Zero speed limit</a> for longer than <a href="#">21.07 Zero speed delay</a> .<br><b>Notes:</b> <ul style="list-style-type: none"> <li>This bit is not updated when mechanical brake control is enabled by par. <a href="#">44.06</a> and the drive is modulating.</li> <li>During a ramp stop when the drive is running forward, the delay count runs whenever <math>[90.01] &lt; [21.06]</math>. From the reverse direction, the delay count runs whenever <math>90.01 &gt; -[21.06]</math>.</li> </ul> | 1 | Forward | 1 = Drive is running in forward direction above zero speed limit, ie. $[90.01] > +[21.06]$ . | 2 | Reverse | 1 = Drive is running in reverse direction above zero speed limit, ie. $[90.01] < -[21.06]$ . | 3 | Out of window | 1 = Speed error window control active (see par. <a href="#">24.41</a> ) | 4 | Internal speed feedback | 1 = Estimated speed feedback used in motor control, ie. estimated speed is selected by par. <a href="#">90.41</a> or <a href="#">90.46</a> , or selected encoder has faulted (par. <a href="#">90.45</a> )<br>0 = Encoder 1 or 2 used for speed feedback | 5 | Encoder 1 feedback | 1 = Encoder 1 used for speed feedback in motor control<br>0 = Encoder 1 faulted or not selected as source of speed feedback (see par. <a href="#">90.41</a> and <a href="#">90.46</a> ) | 6 | Encoder 2 feedback | 1 = Encoder 2 used for speed feedback in motor control<br>0 = Encoder 2 faulted or not selected as source of speed feedback (see par. <a href="#">90.41</a> and <a href="#">90.46</a> ) | 7 | Any constant speed request | 1 = A constant speed or frequency has been selected; see par. <a href="#">06.20</a> . | 8 | Follower speed corr min lim | 1 = Minimum limit of speed correction (in a speed-controlled follower) has been reached (see par. <a href="#">23.39...23.41</a> ). | 9 | Follower speed corr max lim | 1 = Maximum limit of speed correction (in a speed-controlled follower) has been reached (see par. <a href="#">23.39...23.41</a> ). | 10...15 | Reserved |  |  |
| Bit     | Name                             | Description  |            |      |             |   |            |  |   |         |  |   |         |  |   |               |   |   |                         |  |   |                    |   |   |                    |   |   |                            |   |   |                             |  |   |                             |  |         |          |  |  |
| 0       | Zero speed                       | 1 = Drive is running at zero speed, ie. the absolute value of par. <a href="#">90.01 Motor speed for control</a> has remained below <a href="#">21.06 Zero speed limit</a> for longer than <a href="#">21.07 Zero speed delay</a> .<br><b>Notes:</b> <ul style="list-style-type: none"> <li>This bit is not updated when mechanical brake control is enabled by par. <a href="#">44.06</a> and the drive is modulating.</li> <li>During a ramp stop when the drive is running forward, the delay count runs whenever <math>[90.01] &lt; [21.06]</math>. From the reverse direction, the delay count runs whenever <math>90.01 &gt; -[21.06]</math>.</li> </ul>   |            |      |             |   |            |  |   |         |  |   |         |  |   |               |   |   |                         |  |   |                    |   |   |                    |   |   |                            |   |   |                             |  |   |                             |  |         |          |  |  |
| 1       | Forward                          | 1 = Drive is running in forward direction above zero speed limit, ie. $[90.01] > +[21.06]$ .   |            |      |             |   |            |  |   |         |  |   |         |  |   |               |   |   |                         |  |   |                    |   |   |                    |   |   |                            |   |   |                             |  |   |                             |  |         |          |  |  |
| 2       | Reverse                          | 1 = Drive is running in reverse direction above zero speed limit, ie. $[90.01] < -[21.06]$ .   |            |      |             |   |            |  |   |         |  |   |         |  |   |               |   |   |                         |  |   |                    |   |   |                    |   |   |                            |   |   |                             |  |   |                             |  |         |          |  |  |
| 3       | Out of window                    | 1 = Speed error window control active (see par. <a href="#">24.41</a> )  |            |      |             |   |            |  |   |         |  |   |         |  |   |               |   |   |                         |  |   |                    |   |   |                    |   |   |                            |   |   |                             |  |   |                             |  |         |          |  |  |
| 4       | Internal speed feedback          | 1 = Estimated speed feedback used in motor control, ie. estimated speed is selected by par. <a href="#">90.41</a> or <a href="#">90.46</a> , or selected encoder has faulted (par. <a href="#">90.45</a> )<br>0 = Encoder 1 or 2 used for speed feedback   |            |      |             |   |            |  |   |         |  |   |         |  |   |               |   |   |                         |  |   |                    |   |   |                    |   |   |                            |   |   |                             |  |   |                             |  |         |          |  |  |
| 5       | Encoder 1 feedback               | 1 = Encoder 1 used for speed feedback in motor control<br>0 = Encoder 1 faulted or not selected as source of speed feedback (see par. <a href="#">90.41</a> and <a href="#">90.46</a> )  |            |      |             |   |            |  |   |         |  |   |         |  |   |               |   |   |                         |  |   |                    |   |   |                    |   |   |                            |   |   |                             |  |   |                             |  |         |          |  |  |
| 6       | Encoder 2 feedback               | 1 = Encoder 2 used for speed feedback in motor control<br>0 = Encoder 2 faulted or not selected as source of speed feedback (see par. <a href="#">90.41</a> and <a href="#">90.46</a> )  |            |      |             |   |            |  |   |         |  |   |         |  |   |               |   |   |                         |  |   |                    |   |   |                    |   |   |                            |   |   |                             |  |   |                             |  |         |          |  |  |
| 7       | Any constant speed request       | 1 = A constant speed or frequency has been selected; see par. <a href="#">06.20</a> .  |            |      |             |   |            |  |   |         |  |   |         |  |   |               |   |   |                         |  |   |                    |   |   |                    |   |   |                            |   |   |                             |  |   |                             |  |         |          |  |  |
| 8       | Follower speed corr min lim      | 1 = Minimum limit of speed correction (in a speed-controlled follower) has been reached (see par. <a href="#">23.39...23.41</a> ).   |            |      |             |   |            |  |   |         |  |   |         |  |   |               |   |   |                         |  |   |                    |   |   |                    |   |   |                            |   |   |                             |  |   |                             |  |         |          |  |  |
| 9       | Follower speed corr max lim      | 1 = Maximum limit of speed correction (in a speed-controlled follower) has been reached (see par. <a href="#">23.39...23.41</a> ).   |            |      |             |   |            |  |   |         |  |   |         |  |   |               |   |   |                         |  |   |                    |   |   |                    |   |   |                            |   |   |                             |  |   |                             |  |         |          |  |  |
| 10...15 | Reserved                         |  |            |      |             |   |            |  |   |         |  |   |         |  |   |               |   |   |                         |  |   |                    |   |   |                    |   |   |                            |   |   |                             |  |   |                             |  |         |          |  |  |
|         | 0000h...FFFFh                    | Speed control status word.   | 1 = 1      |      |             |   |            |  |   |         |  |   |         |  |   |               |   |   |                         |  |   |                    |   |   |                    |   |   |                            |   |   |                             |  |   |                             |  |         |          |  |  |

| No.   | Name/Value                        | Description  | Def/FbEq16 |     |      |             |   |                  |  |   |                         |   |   |                          |  |   |                     |  |   |                      |  |        |                  |  |   |                  |  |        |          |  |
|---|-----------------------------------|--|------------|-----|------|-------------|---|------------------|--|---|-------------------------|---|---|--------------------------|--|---|---------------------|--|---|----------------------|--|--------|------------------|--|---|------------------|--|--------|----------|--|
| 06.20   | <i>Constant speed status word</i> | Constant speed/frequency status word. Indicates which constant speed or frequency is active (if any). See also parameter <i>06.19 Speed control status word</i> , bit 7, and section <i>Constant speeds/frequencies</i> (page 43).<br>This parameter is read-only. | -          |     |      |             |   |                  |  |   |                         |   |   |                          |  |   |                     |  |   |                      |  |        |                  |  |   |                  |  |        |          |  |
| <table border="1"> <thead> <tr> <th>Bit</th> <th>Name</th> <th>Description</th> </tr> </thead> <tbody> <tr> <td>0</td> <td>Constant speed 1</td> <td>1 = Constant speed or frequency 1 selected</td> </tr> <tr> <td>1</td> <td>Constant speed 2</td> <td>1 = Constant speed or frequency 2 selected</td> </tr> <tr> <td>2</td> <td>Constant speed 3</td> <td>1 = Constant speed or frequency 3 selected</td> </tr> <tr> <td>3</td> <td>Constant speed 4</td> <td>1 = Constant speed or frequency 4 selected</td> </tr> <tr> <td>4</td> <td>Constant speed 5</td> <td>1 = Constant speed or frequency 5 selected</td> </tr> <tr> <td>5</td> <td>Constant speed 6</td> <td>1 = Constant speed or frequency 6 selected</td> </tr> <tr> <td>6</td> <td>Constant speed 7</td> <td>1 = Constant speed or frequency 7 selected</td> </tr> <tr> <td>7...15</td> <td>Reserved</td> <td></td> </tr> </tbody> </table> |                                   |  |            | Bit | Name | Description | 0 | Constant speed 1 | 1 = Constant speed or frequency 1 selected     | 1 | Constant speed 2        | 1 = Constant speed or frequency 2 selected              | 2 | Constant speed 3         | 1 = Constant speed or frequency 3 selected               | 3 | Constant speed 4    | 1 = Constant speed or frequency 4 selected | 4 | Constant speed 5     | 1 = Constant speed or frequency 5 selected   | 5      | Constant speed 6 | 1 = Constant speed or frequency 6 selected | 6 | Constant speed 7 | 1 = Constant speed or frequency 7 selected | 7...15 | Reserved |  |
| Bit   | Name                              | Description  |            |     |      |             |   |                  |  |   |                         |   |   |                          |  |   |                     |  |   |                      |  |        |                  |  |   |                  |  |        |          |  |
| 0   | Constant speed 1                  | 1 = Constant speed or frequency 1 selected   |            |     |      |             |   |                  |  |   |                         |   |   |                          |  |   |                     |  |   |                      |  |        |                  |  |   |                  |  |        |          |  |
| 1   | Constant speed 2                  | 1 = Constant speed or frequency 2 selected   |            |     |      |             |   |                  |  |   |                         |   |   |                          |  |   |                     |  |   |                      |  |        |                  |  |   |                  |  |        |          |  |
| 2   | Constant speed 3                  | 1 = Constant speed or frequency 3 selected   |            |     |      |             |   |                  |  |   |                         |   |   |                          |  |   |                     |  |   |                      |  |        |                  |  |   |                  |  |        |          |  |
| 3   | Constant speed 4                  | 1 = Constant speed or frequency 4 selected   |            |     |      |             |   |                  |  |   |                         |   |   |                          |  |   |                     |  |   |                      |  |        |                  |  |   |                  |  |        |          |  |
| 4   | Constant speed 5                  | 1 = Constant speed or frequency 5 selected   |            |     |      |             |   |                  |  |   |                         |   |   |                          |  |   |                     |  |   |                      |  |        |                  |  |   |                  |  |        |          |  |
| 5   | Constant speed 6                  | 1 = Constant speed or frequency 6 selected   |            |     |      |             |   |                  |  |   |                         |   |   |                          |  |   |                     |  |   |                      |  |        |                  |  |   |                  |  |        |          |  |
| 6   | Constant speed 7                  | 1 = Constant speed or frequency 7 selected   |            |     |      |             |   |                  |  |   |                         |   |   |                          |  |   |                     |  |   |                      |  |        |                  |  |   |                  |  |        |          |  |
| 7...15  | Reserved                          |  |            |     |      |             |   |                  |  |   |                         |   |   |                          |  |   |                     |  |   |                      |  |        |                  |  |   |                  |  |        |          |  |
|   | 0000h...FFFFh                     | Constant speed/frequency status word.  | 1 = 1      |     |      |             |   |                  |  |   |                         |   |   |                          |  |   |                     |  |   |                      |  |        |                  |  |   |                  |  |        |          |  |
| 06.21   | <i>Drive status word 3</i>        | Drive status word 3.<br>This parameter is read-only.   | -          |     |      |             |   |                  |  |   |                         |   |   |                          |  |   |                     |  |   |                      |  |        |                  |  |   |                  |  |        |          |  |
| <table border="1"> <thead> <tr> <th>Bit</th> <th>Name</th> <th>Description</th> </tr> </thead> <tbody> <tr> <td>0</td> <td>DC hold active</td> <td>1 = DC hold is active (see par. <i>21.08</i>)</td> </tr> <tr> <td>1</td> <td>Post-magnetizing active</td> <td>1 = Post-magnetizing is active (see par. <i>21.08</i>)</td> </tr> <tr> <td>2</td> <td>Motor pre-heating active</td> <td>1 = Motor pre-heating is active (see par. <i>21.14</i>)</td> </tr> <tr> <td>3</td> <td>Smooth start active</td> <td>Reserved.</td> </tr> <tr> <td>4</td> <td>Rotor position known</td> <td>1 = Rotor position has been determined (autophasing not needed). See section <i>Autophasing</i> (page 59).</td> </tr> <tr> <td>5...15</td> <td>Reserved</td> <td></td> </tr> </tbody> </table>  |                                   |  |            | Bit | Name | Description | 0 | DC hold active   | 1 = DC hold is active (see par. <i>21.08</i> ) | 1 | Post-magnetizing active | 1 = Post-magnetizing is active (see par. <i>21.08</i> ) | 2 | Motor pre-heating active | 1 = Motor pre-heating is active (see par. <i>21.14</i> ) | 3 | Smooth start active | Reserved.                                  | 4 | Rotor position known | 1 = Rotor position has been determined (autophasing not needed). See section <i>Autophasing</i> (page 59). | 5...15 | Reserved         |  |   |                  |  |        |          |  |
| Bit   | Name                              | Description  |            |     |      |             |   |                  |  |   |                         |   |   |                          |  |   |                     |  |   |                      |  |        |                  |  |   |                  |  |        |          |  |
| 0   | DC hold active                    | 1 = DC hold is active (see par. <i>21.08</i> )   |            |     |      |             |   |                  |  |   |                         |   |   |                          |  |   |                     |  |   |                      |  |        |                  |  |   |                  |  |        |          |  |
| 1   | Post-magnetizing active           | 1 = Post-magnetizing is active (see par. <i>21.08</i> )  |            |     |      |             |   |                  |  |   |                         |   |   |                          |  |   |                     |  |   |                      |  |        |                  |  |   |                  |  |        |          |  |
| 2   | Motor pre-heating active          | 1 = Motor pre-heating is active (see par. <i>21.14</i> )   |            |     |      |             |   |                  |  |   |                         |   |   |                          |  |   |                     |  |   |                      |  |        |                  |  |   |                  |  |        |          |  |
| 3   | Smooth start active               | Reserved.  |            |     |      |             |   |                  |  |   |                         |   |   |                          |  |   |                     |  |   |                      |  |        |                  |  |   |                  |  |        |          |  |
| 4   | Rotor position known              | 1 = Rotor position has been determined (autophasing not needed). See section <i>Autophasing</i> (page 59).   |            |     |      |             |   |                  |  |   |                         |   |   |                          |  |   |                     |  |   |                      |  |        |                  |  |   |                  |  |        |          |  |
| 5...15  | Reserved                          |  |            |     |      |             |   |                  |  |   |                         |   |   |                          |  |   |                     |  |   |                      |  |        |                  |  |   |                  |  |        |          |  |
|   | 0000h...FFFFh                     | Drive status word 3.   | 1 = 1      |     |      |             |   |                  |  |   |                         |   |   |                          |  |   |                     |  |   |                      |  |        |                  |  |   |                  |  |        |          |  |

| No.  | Name/Value   | Description  | Def/FbEq16            |     |      |             |      |   |                |  |   |   |             |  |   |   |          |  |  |   |                  |   |   |   |                            |   |   |        |          |  |  |   |  |   |  |
|--|--|--|-----------------------|-----|------|-------------|------|---|----------------|--|---|---|-------------|--|---|---|----------|--|--|---|------------------|---|---|---|----------------------------|---|---|--------|----------|--|--|---|--|---|--|
| 06.25  | <i>Drive inhibit status word 2</i>   | Drive inhibit status word 2. This word specifies the source of the inhibiting condition that is preventing the drive from starting. After the condition is removed, the start command must be cycled. See bit-specific notes.<br>See also parameter <i>06.18 Start inhibit status word</i> , and <i>06.16 Drive status word 1</i> , bit 1.<br>This parameter is read-only. | -                     |     |      |             |      |   |                |  |   |   |             |  |   |   |          |  |  |   |                  |   |   |   |                            |   |   |        |          |  |  |   |  |   |  |
| <table border="1"> <thead> <tr> <th>Bit</th> <th>Name</th> <th>Description</th> <th>Note</th> </tr> </thead> <tbody> <tr> <td>0</td> <td>Follower drive</td> <td>1 = A follower is preventing the master from starting.</td> <td>a</td> </tr> <tr> <td>1</td> <td>Application</td> <td>1 = The application program is preventing the drive from starting.</td> <td>b</td> </tr> <tr> <td>2</td> <td>Reserved</td> <td></td> <td></td> </tr> <tr> <td>3</td> <td>Encoder feedback</td> <td>1 = The encoder feedback configuration is preventing the drive from starting.</td> <td>a</td> </tr> <tr> <td>4</td> <td>Ref source parametrization</td> <td>1 = A reference source parametrization conflict is preventing the drive from starting. See warning <i>A6DA Reference source parametrization</i> (page 497).</td> <td>b</td> </tr> <tr> <td>5...15</td> <td>Reserved</td> <td></td> <td></td> </tr> </tbody> </table> <p><b>Notes:</b></p> <table border="1"> <tbody> <tr> <td>a</td> <td>If bit 1 of <i>06.16 Drive status word 1</i> is still set after the removal of the inhibiting condition, and edge triggering is selected for the active external control location, a fresh rising-edge start signal is required. See parameters <i>20.02</i>, <i>20.07</i> and <i>20.19</i>.</td> </tr> <tr> <td>b</td> <td>If bit 1 of <i>06.16 Drive status word 1</i> is still set after the removal of the inhibiting condition, a fresh rising-edge start signal is required.</td> </tr> </tbody> </table> |  |  |                       | Bit | Name | Description | Note | 0 | Follower drive | 1 = A follower is preventing the master from starting. | a | 1 | Application | 1 = The application program is preventing the drive from starting. | b | 2 | Reserved |  |  | 3 | Encoder feedback | 1 = The encoder feedback configuration is preventing the drive from starting. | a | 4 | Ref source parametrization | 1 = A reference source parametrization conflict is preventing the drive from starting. See warning <i>A6DA Reference source parametrization</i> (page 497). | b | 5...15 | Reserved |  |  | a | If bit 1 of <i>06.16 Drive status word 1</i> is still set after the removal of the inhibiting condition, and edge triggering is selected for the active external control location, a fresh rising-edge start signal is required. See parameters <i>20.02</i> , <i>20.07</i> and <i>20.19</i> . | b | If bit 1 of <i>06.16 Drive status word 1</i> is still set after the removal of the inhibiting condition, a fresh rising-edge start signal is required. |
| Bit  | Name   | Description  | Note                  |     |      |             |      |   |                |  |   |   |             |  |   |   |          |  |  |   |                  |   |   |   |                            |   |   |        |          |  |  |   |  |   |  |
| 0  | Follower drive   | 1 = A follower is preventing the master from starting.   | a                     |     |      |             |      |   |                |  |   |   |             |  |   |   |          |  |  |   |                  |   |   |   |                            |   |   |        |          |  |  |   |  |   |  |
| 1  | Application  | 1 = The application program is preventing the drive from starting.   | b                     |     |      |             |      |   |                |  |   |   |             |  |   |   |          |  |  |   |                  |   |   |   |                            |   |   |        |          |  |  |   |  |   |  |
| 2  | Reserved   |  |                       |     |      |             |      |   |                |  |   |   |             |  |   |   |          |  |  |   |                  |   |   |   |                            |   |   |        |          |  |  |   |  |   |  |
| 3  | Encoder feedback   | 1 = The encoder feedback configuration is preventing the drive from starting.  | a                     |     |      |             |      |   |                |  |   |   |             |  |   |   |          |  |  |   |                  |   |   |   |                            |   |   |        |          |  |  |   |  |   |  |
| 4  | Ref source parametrization   | 1 = A reference source parametrization conflict is preventing the drive from starting. See warning <i>A6DA Reference source parametrization</i> (page 497).  | b                     |     |      |             |      |   |                |  |   |   |             |  |   |   |          |  |  |   |                  |   |   |   |                            |   |   |        |          |  |  |   |  |   |  |
| 5...15   | Reserved   |  |                       |     |      |             |      |   |                |  |   |   |             |  |   |   |          |  |  |   |                  |   |   |   |                            |   |   |        |          |  |  |   |  |   |  |
| a  | If bit 1 of <i>06.16 Drive status word 1</i> is still set after the removal of the inhibiting condition, and edge triggering is selected for the active external control location, a fresh rising-edge start signal is required. See parameters <i>20.02</i> , <i>20.07</i> and <i>20.19</i> . |  |                       |     |      |             |      |   |                |  |   |   |             |  |   |   |          |  |  |   |                  |   |   |   |                            |   |   |        |          |  |  |   |  |   |  |
| b  | If bit 1 of <i>06.16 Drive status word 1</i> is still set after the removal of the inhibiting condition, a fresh rising-edge start signal is required.   |  |                       |     |      |             |      |   |                |  |   |   |             |  |   |   |          |  |  |   |                  |   |   |   |                            |   |   |        |          |  |  |   |  |   |  |
|  | 0000h...FFFFh  | Start inhibit status word 2.   | 1 = 1                 |     |      |             |      |   |                |  |   |   |             |  |   |   |          |  |  |   |                  |   |   |   |                            |   |   |        |          |  |  |   |  |   |  |
| 06.29  | <i>MSW bit 10 sel</i>  | Selects a binary source whose status is transmitted as bit 10 of <i>06.11 Main status word</i> .   | <i>Above limit</i>    |     |      |             |      |   |                |  |   |   |             |  |   |   |          |  |  |   |                  |   |   |   |                            |   |   |        |          |  |  |   |  |   |  |
|  | False  | 0.   | 0                     |     |      |             |      |   |                |  |   |   |             |  |   |   |          |  |  |   |                  |   |   |   |                            |   |   |        |          |  |  |   |  |   |  |
|  | True   | 1.   | 1                     |     |      |             |      |   |                |  |   |   |             |  |   |   |          |  |  |   |                  |   |   |   |                            |   |   |        |          |  |  |   |  |   |  |
|  | Above limit  | Bit 10 of <i>06.17 Drive status word 2</i> (see page 131).   | 2                     |     |      |             |      |   |                |  |   |   |             |  |   |   |          |  |  |   |                  |   |   |   |                            |   |   |        |          |  |  |   |  |   |  |
|  | <i>Other [bit]</i>   | Source selection (see <i>Terms and abbreviations</i> on page 112).   | -                     |     |      |             |      |   |                |  |   |   |             |  |   |   |          |  |  |   |                  |   |   |   |                            |   |   |        |          |  |  |   |  |   |  |
| 06.30  | <i>MSW bit 11 sel</i>  | Selects a binary source whose status is transmitted as bit 11 of <i>06.11 Main status word</i> .   | <i>Ext ctrl loc</i>   |     |      |             |      |   |                |  |   |   |             |  |   |   |          |  |  |   |                  |   |   |   |                            |   |   |        |          |  |  |   |  |   |  |
|  | False  | 0.   | 0                     |     |      |             |      |   |                |  |   |   |             |  |   |   |          |  |  |   |                  |   |   |   |                            |   |   |        |          |  |  |   |  |   |  |
|  | True   | 1.   | 1                     |     |      |             |      |   |                |  |   |   |             |  |   |   |          |  |  |   |                  |   |   |   |                            |   |   |        |          |  |  |   |  |   |  |
|  | Ext ctrl loc   | Bit 11 of <i>06.01 Main control word</i> (see page 128).   | 2                     |     |      |             |      |   |                |  |   |   |             |  |   |   |          |  |  |   |                  |   |   |   |                            |   |   |        |          |  |  |   |  |   |  |
|  | <i>Other [bit]</i>   | Source selection (see <i>Terms and abbreviations</i> on page 112).   | -                     |     |      |             |      |   |                |  |   |   |             |  |   |   |          |  |  |   |                  |   |   |   |                            |   |   |        |          |  |  |   |  |   |  |
| 06.31  | <i>MSW bit 12 sel</i>  | Selects a binary source whose status is transmitted as bit 12 of <i>06.11 Main status word</i> .   | <i>Ext run enable</i> |     |      |             |      |   |                |  |   |   |             |  |   |   |          |  |  |   |                  |   |   |   |                            |   |   |        |          |  |  |   |  |   |  |
|  | False  | 0.   | 0                     |     |      |             |      |   |                |  |   |   |             |  |   |   |          |  |  |   |                  |   |   |   |                            |   |   |        |          |  |  |   |  |   |  |
|  | True   | 1.   | 1                     |     |      |             |      |   |                |  |   |   |             |  |   |   |          |  |  |   |                  |   |   |   |                            |   |   |        |          |  |  |   |  |   |  |
|  | Ext run enable   | Inverted bit 5 of <i>06.18 Start inhibit status word</i> (see page 132).   | 2                     |     |      |             |      |   |                |  |   |   |             |  |   |   |          |  |  |   |                  |   |   |   |                            |   |   |        |          |  |  |   |  |   |  |
|  | <i>Other [bit]</i>   | Source selection (see <i>Terms and abbreviations</i> on page 112).   | -                     |     |      |             |      |   |                |  |   |   |             |  |   |   |          |  |  |   |                  |   |   |   |                            |   |   |        |          |  |  |   |  |   |  |

| No.   | Name/Value             | Description   | Def/FbEq16   |     |      |             |   |          |                        |   |           |                                       |   |           |                       |   |         |                       |       |          |  |   |         |                         |   |            |                                   |   |        |  |    |        |                               |         |          |  |    |                       |                            |    |          |  |    |          |  |
|---|------------------------|---|--------------|-----|------|-------------|---|----------|------------------------|---|-----------|---------------------------------------|---|-----------|-----------------------|---|---------|-----------------------|-------|----------|--|---|---------|-------------------------|---|------------|-----------------------------------|---|--------|--|----|--------|-------------------------------|---------|----------|--|----|-----------------------|----------------------------|----|----------|--|----|----------|--|
| 06.32   | <i>MSW bit 13 sel</i>  | Selects a binary source whose status is transmitted as bit 13 of <i>06.11 Main status word</i> .  | <i>False</i> |     |      |             |   |          |                        |   |           |                                       |   |           |                       |   |         |                       |       |          |  |   |         |                         |   |            |                                   |   |        |  |    |        |                               |         |          |  |    |                       |                            |    |          |  |    |          |  |
|   | False                  | 0.  | 0            |     |      |             |   |          |                        |   |           |                                       |   |           |                       |   |         |                       |       |          |  |   |         |                         |   |            |                                   |   |        |  |    |        |                               |         |          |  |    |                       |                            |    |          |  |    |          |  |
|   | True                   | 1.  | 1            |     |      |             |   |          |                        |   |           |                                       |   |           |                       |   |         |                       |       |          |  |   |         |                         |   |            |                                   |   |        |  |    |        |                               |         |          |  |    |                       |                            |    |          |  |    |          |  |
|   | <i>Other [bit]</i>     | Source selection (see <i>Terms and abbreviations</i> on page 112).  | -            |     |      |             |   |          |                        |   |           |                                       |   |           |                       |   |         |                       |       |          |  |   |         |                         |   |            |                                   |   |        |  |    |        |                               |         |          |  |    |                       |                            |    |          |  |    |          |  |
| 06.33   | <i>MSW bit 14 sel</i>  | Selects a binary source whose status is transmitted as bit 14 of <i>06.11 Main status word</i> .  | <i>False</i> |     |      |             |   |          |                        |   |           |                                       |   |           |                       |   |         |                       |       |          |  |   |         |                         |   |            |                                   |   |        |  |    |        |                               |         |          |  |    |                       |                            |    |          |  |    |          |  |
|   | False                  | 0.  | 0            |     |      |             |   |          |                        |   |           |                                       |   |           |                       |   |         |                       |       |          |  |   |         |                         |   |            |                                   |   |        |  |    |        |                               |         |          |  |    |                       |                            |    |          |  |    |          |  |
|   | True                   | 1.  | 1            |     |      |             |   |          |                        |   |           |                                       |   |           |                       |   |         |                       |       |          |  |   |         |                         |   |            |                                   |   |        |  |    |        |                               |         |          |  |    |                       |                            |    |          |  |    |          |  |
|   | <i>Other [bit]</i>     | Source selection (see <i>Terms and abbreviations</i> on page 112).  | -            |     |      |             |   |          |                        |   |           |                                       |   |           |                       |   |         |                       |       |          |  |   |         |                         |   |            |                                   |   |        |  |    |        |                               |         |          |  |    |                       |                            |    |          |  |    |          |  |
| 06.36   | <i>LSU Status Word</i> | <i>(Only visible when supply unit control activated by 95.20)</i><br>Shows the status of the supply unit.<br>See also section <i>Control of a supply unit (LSU)</i> (page 40), and parameter group <i>60 DDCS communication</i> .<br>This parameter is read-only. | -            |     |      |             |   |          |                        |   |           |                                       |   |           |                       |   |         |                       |       |          |  |   |         |                         |   |            |                                   |   |        |  |    |        |                               |         |          |  |    |                       |                            |    |          |  |    |          |  |
| <table border="1"> <thead> <tr> <th>Bit</th> <th>Name</th> <th>Description</th> </tr> </thead> <tbody> <tr> <td>0</td> <td>Ready on</td> <td>1 = Ready to switch on</td> </tr> <tr> <td>1</td> <td>Ready run</td> <td>1 = Ready to operate, DC link charged</td> </tr> <tr> <td>2</td> <td>Ready ref</td> <td>1 = Operation enabled</td> </tr> <tr> <td>3</td> <td>Tripped</td> <td>1 = A fault is active</td> </tr> <tr> <td>4...6</td> <td>Reserved</td> <td></td> </tr> <tr> <td>7</td> <td>Warning</td> <td>1 = A warning is active</td> </tr> <tr> <td>8</td> <td>Modulating</td> <td>1 = The supply unit is modulating</td> </tr> <tr> <td>9</td> <td>Remote</td> <td>1 = Remote control (EXT1 or EXT2)<br/>0 = Local control</td> </tr> <tr> <td>10</td> <td>Net ok</td> <td>1 = Supply network voltage OK</td> </tr> <tr> <td>11...12</td> <td>Reserved</td> <td></td> </tr> <tr> <td>13</td> <td>Charging or ready run</td> <td>1 = Bit 1 or bit 14 active</td> </tr> <tr> <td>14</td> <td>Charging</td> <td>1 = Charging contactor closed<br/>0 = Charging contactor open</td> </tr> <tr> <td>15</td> <td>Reserved</td> <td></td> </tr> </tbody> </table> |                        |   |              | Bit | Name | Description | 0 | Ready on | 1 = Ready to switch on | 1 | Ready run | 1 = Ready to operate, DC link charged | 2 | Ready ref | 1 = Operation enabled | 3 | Tripped | 1 = A fault is active | 4...6 | Reserved |  | 7 | Warning | 1 = A warning is active | 8 | Modulating | 1 = The supply unit is modulating | 9 | Remote | 1 = Remote control (EXT1 or EXT2)<br>0 = Local control | 10 | Net ok | 1 = Supply network voltage OK | 11...12 | Reserved |  | 13 | Charging or ready run | 1 = Bit 1 or bit 14 active | 14 | Charging | 1 = Charging contactor closed<br>0 = Charging contactor open | 15 | Reserved |  |
| Bit   | Name                   | Description   |              |     |      |             |   |          |                        |   |           |                                       |   |           |                       |   |         |                       |       |          |  |   |         |                         |   |            |                                   |   |        |  |    |        |                               |         |          |  |    |                       |                            |    |          |  |    |          |  |
| 0   | Ready on               | 1 = Ready to switch on  |              |     |      |             |   |          |                        |   |           |                                       |   |           |                       |   |         |                       |       |          |  |   |         |                         |   |            |                                   |   |        |  |    |        |                               |         |          |  |    |                       |                            |    |          |  |    |          |  |
| 1   | Ready run              | 1 = Ready to operate, DC link charged   |              |     |      |             |   |          |                        |   |           |                                       |   |           |                       |   |         |                       |       |          |  |   |         |                         |   |            |                                   |   |        |  |    |        |                               |         |          |  |    |                       |                            |    |          |  |    |          |  |
| 2   | Ready ref              | 1 = Operation enabled   |              |     |      |             |   |          |                        |   |           |                                       |   |           |                       |   |         |                       |       |          |  |   |         |                         |   |            |                                   |   |        |  |    |        |                               |         |          |  |    |                       |                            |    |          |  |    |          |  |
| 3   | Tripped                | 1 = A fault is active   |              |     |      |             |   |          |                        |   |           |                                       |   |           |                       |   |         |                       |       |          |  |   |         |                         |   |            |                                   |   |        |  |    |        |                               |         |          |  |    |                       |                            |    |          |  |    |          |  |
| 4...6   | Reserved               |   |              |     |      |             |   |          |                        |   |           |                                       |   |           |                       |   |         |                       |       |          |  |   |         |                         |   |            |                                   |   |        |  |    |        |                               |         |          |  |    |                       |                            |    |          |  |    |          |  |
| 7   | Warning                | 1 = A warning is active   |              |     |      |             |   |          |                        |   |           |                                       |   |           |                       |   |         |                       |       |          |  |   |         |                         |   |            |                                   |   |        |  |    |        |                               |         |          |  |    |                       |                            |    |          |  |    |          |  |
| 8   | Modulating             | 1 = The supply unit is modulating   |              |     |      |             |   |          |                        |   |           |                                       |   |           |                       |   |         |                       |       |          |  |   |         |                         |   |            |                                   |   |        |  |    |        |                               |         |          |  |    |                       |                            |    |          |  |    |          |  |
| 9   | Remote                 | 1 = Remote control (EXT1 or EXT2)<br>0 = Local control  |              |     |      |             |   |          |                        |   |           |                                       |   |           |                       |   |         |                       |       |          |  |   |         |                         |   |            |                                   |   |        |  |    |        |                               |         |          |  |    |                       |                            |    |          |  |    |          |  |
| 10  | Net ok                 | 1 = Supply network voltage OK   |              |     |      |             |   |          |                        |   |           |                                       |   |           |                       |   |         |                       |       |          |  |   |         |                         |   |            |                                   |   |        |  |    |        |                               |         |          |  |    |                       |                            |    |          |  |    |          |  |
| 11...12   | Reserved               |   |              |     |      |             |   |          |                        |   |           |                                       |   |           |                       |   |         |                       |       |          |  |   |         |                         |   |            |                                   |   |        |  |    |        |                               |         |          |  |    |                       |                            |    |          |  |    |          |  |
| 13  | Charging or ready run  | 1 = Bit 1 or bit 14 active  |              |     |      |             |   |          |                        |   |           |                                       |   |           |                       |   |         |                       |       |          |  |   |         |                         |   |            |                                   |   |        |  |    |        |                               |         |          |  |    |                       |                            |    |          |  |    |          |  |
| 14  | Charging               | 1 = Charging contactor closed<br>0 = Charging contactor open  |              |     |      |             |   |          |                        |   |           |                                       |   |           |                       |   |         |                       |       |          |  |   |         |                         |   |            |                                   |   |        |  |    |        |                               |         |          |  |    |                       |                            |    |          |  |    |          |  |
| 15  | Reserved               |   |              |     |      |             |   |          |                        |   |           |                                       |   |           |                       |   |         |                       |       |          |  |   |         |                         |   |            |                                   |   |        |  |    |        |                               |         |          |  |    |                       |                            |    |          |  |    |          |  |
| 0000h...FFFFh   |                        | Supply unit status word.  | 1 = 1        |     |      |             |   |          |                        |   |           |                                       |   |           |                       |   |         |                       |       |          |  |   |         |                         |   |            |                                   |   |        |  |    |        |                               |         |          |  |    |                       |                            |    |          |  |    |          |  |



| No.    | Name/Value                           | Description   | Def/FbEq16            |      |             |   |        |  |   |       |                           |   |       |                           |   |       |   |       |          |  |   |       |  |        |          |  |    |            |   |    |            |   |    |            |   |    |            |   |  |
|--------|--------------------------------------|---|-----------------------|------|-------------|---|--------|--|---|-------|---------------------------|---|-------|---------------------------|---|-------|---|-------|----------|--|---|-------|--|--------|----------|--|----|------------|---|----|------------|---|----|------------|---|----|------------|---|--|
| 06.39  | <i>Internal state machine LSU CW</i> | (Only visible when supply unit control activated by 95.20)<br>Shows the control word sent to the supply unit from the INU-LSU (inverter unit/supply unit) state machine.<br>This parameter is read-only.  | -                     |      |             |   |        |  |   |       |                           |   |       |                           |   |       |   |       |          |  |   |       |  |        |          |  |    |            |   |    |            |   |    |            |   |    |            |   |  |
|        |                                      | <table border="1"> <thead> <tr> <th>Bit</th> <th>Name</th> <th>Description</th> </tr> </thead> <tbody> <tr> <td>0</td> <td>ON/OFF</td> <td>1 = Start charging<br/>0 = Open main contactor (switch power off)</td> </tr> <tr> <td>1</td> <td>OFF 2</td> <td>0 = Emergency stop (Off2)</td> </tr> <tr> <td>2</td> <td>OFF 3</td> <td>0 = Emergency stop (Off3)</td> </tr> <tr> <td>3</td> <td>START</td> <td>1 = Start modulating<br/>0 = Stop modulating</td> </tr> <tr> <td>4...6</td> <td>Reserved</td> <td></td> </tr> <tr> <td>7</td> <td>RESET</td> <td>0 -&gt; 1 = Reset an active fault. A fresh start command is required after reset.</td> </tr> <tr> <td>8...11</td> <td>Reserved</td> <td></td> </tr> <tr> <td>12</td> <td>USER BIT 0</td> <td>See parameter <a href="#">06.40 LSU CW user bit 0 selection</a>.</td> </tr> <tr> <td>13</td> <td>USER BIT 1</td> <td>See parameter <a href="#">06.41 LSU CW user bit 1 selection</a>.</td> </tr> <tr> <td>14</td> <td>USER BIT 2</td> <td>See parameter <a href="#">06.42 LSU CW user bit 2 selection</a>.</td> </tr> <tr> <td>15</td> <td>USER BIT 3</td> <td>See parameter <a href="#">06.43 LSU CW user bit 3 selection</a>.</td> </tr> </tbody> </table> | Bit                   | Name | Description | 0 | ON/OFF | 1 = Start charging<br>0 = Open main contactor (switch power off) | 1 | OFF 2 | 0 = Emergency stop (Off2) | 2 | OFF 3 | 0 = Emergency stop (Off3) | 3 | START | 1 = Start modulating<br>0 = Stop modulating | 4...6 | Reserved |  | 7 | RESET | 0 -> 1 = Reset an active fault. A fresh start command is required after reset. | 8...11 | Reserved |  | 12 | USER BIT 0 | See parameter <a href="#">06.40 LSU CW user bit 0 selection</a> . | 13 | USER BIT 1 | See parameter <a href="#">06.41 LSU CW user bit 1 selection</a> . | 14 | USER BIT 2 | See parameter <a href="#">06.42 LSU CW user bit 2 selection</a> . | 15 | USER BIT 3 | See parameter <a href="#">06.43 LSU CW user bit 3 selection</a> . |  |
| Bit    | Name                                 | Description   |                       |      |             |   |        |  |   |       |                           |   |       |                           |   |       |   |       |          |  |   |       |  |        |          |  |    |            |   |    |            |   |    |            |   |    |            |   |  |
| 0      | ON/OFF                               | 1 = Start charging<br>0 = Open main contactor (switch power off)  |                       |      |             |   |        |  |   |       |                           |   |       |                           |   |       |   |       |          |  |   |       |  |        |          |  |    |            |   |    |            |   |    |            |   |    |            |   |  |
| 1      | OFF 2                                | 0 = Emergency stop (Off2)   |                       |      |             |   |        |  |   |       |                           |   |       |                           |   |       |   |       |          |  |   |       |  |        |          |  |    |            |   |    |            |   |    |            |   |    |            |   |  |
| 2      | OFF 3                                | 0 = Emergency stop (Off3)   |                       |      |             |   |        |  |   |       |                           |   |       |                           |   |       |   |       |          |  |   |       |  |        |          |  |    |            |   |    |            |   |    |            |   |    |            |   |  |
| 3      | START                                | 1 = Start modulating<br>0 = Stop modulating   |                       |      |             |   |        |  |   |       |                           |   |       |                           |   |       |   |       |          |  |   |       |  |        |          |  |    |            |   |    |            |   |    |            |   |    |            |   |  |
| 4...6  | Reserved                             |   |                       |      |             |   |        |  |   |       |                           |   |       |                           |   |       |   |       |          |  |   |       |  |        |          |  |    |            |   |    |            |   |    |            |   |    |            |   |  |
| 7      | RESET                                | 0 -> 1 = Reset an active fault. A fresh start command is required after reset.  |                       |      |             |   |        |  |   |       |                           |   |       |                           |   |       |   |       |          |  |   |       |  |        |          |  |    |            |   |    |            |   |    |            |   |    |            |   |  |
| 8...11 | Reserved                             |   |                       |      |             |   |        |  |   |       |                           |   |       |                           |   |       |   |       |          |  |   |       |  |        |          |  |    |            |   |    |            |   |    |            |   |    |            |   |  |
| 12     | USER BIT 0                           | See parameter <a href="#">06.40 LSU CW user bit 0 selection</a> .   |                       |      |             |   |        |  |   |       |                           |   |       |                           |   |       |   |       |          |  |   |       |  |        |          |  |    |            |   |    |            |   |    |            |   |    |            |   |  |
| 13     | USER BIT 1                           | See parameter <a href="#">06.41 LSU CW user bit 1 selection</a> .   |                       |      |             |   |        |  |   |       |                           |   |       |                           |   |       |   |       |          |  |   |       |  |        |          |  |    |            |   |    |            |   |    |            |   |    |            |   |  |
| 14     | USER BIT 2                           | See parameter <a href="#">06.42 LSU CW user bit 2 selection</a> .   |                       |      |             |   |        |  |   |       |                           |   |       |                           |   |       |   |       |          |  |   |       |  |        |          |  |    |            |   |    |            |   |    |            |   |    |            |   |  |
| 15     | USER BIT 3                           | See parameter <a href="#">06.43 LSU CW user bit 3 selection</a> .   |                       |      |             |   |        |  |   |       |                           |   |       |                           |   |       |   |       |          |  |   |       |  |        |          |  |    |            |   |    |            |   |    |            |   |    |            |   |  |
|        | 0000h...FFFFh                        | Supply unit control word.   | 1 = 1                 |      |             |   |        |  |   |       |                           |   |       |                           |   |       |   |       |          |  |   |       |  |        |          |  |    |            |   |    |            |   |    |            |   |    |            |   |  |
| 06.40  | <i>LSU CW user bit 0 selection</i>   | (Only visible when supply unit control activated by 95.20)<br>Selects a binary source whose status is transmitted as bit 12 of <a href="#">06.39 Internal state machine LSU CW</a> to the supply unit.  | <i>MCW user bit 0</i> |      |             |   |        |  |   |       |                           |   |       |                           |   |       |   |       |          |  |   |       |  |        |          |  |    |            |   |    |            |   |    |            |   |    |            |   |  |
|        | False                                | 0.  | 0                     |      |             |   |        |  |   |       |                           |   |       |                           |   |       |   |       |          |  |   |       |  |        |          |  |    |            |   |    |            |   |    |            |   |    |            |   |  |
|        | True                                 | 1.  | 1                     |      |             |   |        |  |   |       |                           |   |       |                           |   |       |   |       |          |  |   |       |  |        |          |  |    |            |   |    |            |   |    |            |   |    |            |   |  |
|        | MCW user bit 0                       | Bit 12 of <a href="#">06.01 Main control word</a> (see page 128).   | 2                     |      |             |   |        |  |   |       |                           |   |       |                           |   |       |   |       |          |  |   |       |  |        |          |  |    |            |   |    |            |   |    |            |   |    |            |   |  |
|        | MCW user bit 1                       | Bit 13 of <a href="#">06.01 Main control word</a> (see page 128).   | 3                     |      |             |   |        |  |   |       |                           |   |       |                           |   |       |   |       |          |  |   |       |  |        |          |  |    |            |   |    |            |   |    |            |   |    |            |   |  |
|        | MCW user bit 2                       | Bit 14 of <a href="#">06.01 Main control word</a> (see page 128).   | 4                     |      |             |   |        |  |   |       |                           |   |       |                           |   |       |   |       |          |  |   |       |  |        |          |  |    |            |   |    |            |   |    |            |   |    |            |   |  |
|        | MCW user bit 3                       | Bit 15 of <a href="#">06.01 Main control word</a> (see page 128).   | 5                     |      |             |   |        |  |   |       |                           |   |       |                           |   |       |   |       |          |  |   |       |  |        |          |  |    |            |   |    |            |   |    |            |   |    |            |   |  |
|        | <i>Other [bit]</i>                   | Source selection (see <a href="#">Terms and abbreviations</a> on page 112).   | -                     |      |             |   |        |  |   |       |                           |   |       |                           |   |       |   |       |          |  |   |       |  |        |          |  |    |            |   |    |            |   |    |            |   |    |            |   |  |
| 06.41  | <i>LSU CW user bit 1 selection</i>   | (Only visible when supply unit control activated by 95.20)<br>Selects a binary source whose status is transmitted as bit 13 of <a href="#">06.39 Internal state machine LSU CW</a> to the supply unit.  | <i>MCW user bit 1</i> |      |             |   |        |  |   |       |                           |   |       |                           |   |       |   |       |          |  |   |       |  |        |          |  |    |            |   |    |            |   |    |            |   |    |            |   |  |
|        | False                                | 0.  | 0                     |      |             |   |        |  |   |       |                           |   |       |                           |   |       |   |       |          |  |   |       |  |        |          |  |    |            |   |    |            |   |    |            |   |    |            |   |  |
|        | True                                 | 1.  | 1                     |      |             |   |        |  |   |       |                           |   |       |                           |   |       |   |       |          |  |   |       |  |        |          |  |    |            |   |    |            |   |    |            |   |    |            |   |  |
|        | MCW user bit 0                       | Bit 12 of <a href="#">06.01 Main control word</a> (see page 128).   | 2                     |      |             |   |        |  |   |       |                           |   |       |                           |   |       |   |       |          |  |   |       |  |        |          |  |    |            |   |    |            |   |    |            |   |    |            |   |  |
|        | MCW user bit 1                       | Bit 13 of <a href="#">06.01 Main control word</a> (see page 128).   | 3                     |      |             |   |        |  |   |       |                           |   |       |                           |   |       |   |       |          |  |   |       |  |        |          |  |    |            |   |    |            |   |    |            |   |    |            |   |  |
|        | MCW user bit 2                       | Bit 14 of <a href="#">06.01 Main control word</a> (see page 128).   | 4                     |      |             |   |        |  |   |       |                           |   |       |                           |   |       |   |       |          |  |   |       |  |        |          |  |    |            |   |    |            |   |    |            |   |    |            |   |  |
|        | MCW user bit 3                       | Bit 15 of <a href="#">06.01 Main control word</a> (see page 128).   | 5                     |      |             |   |        |  |   |       |                           |   |       |                           |   |       |   |       |          |  |   |       |  |        |          |  |    |            |   |    |            |   |    |            |   |    |            |   |  |
|        | <i>Other [bit]</i>                   | Source selection (see <a href="#">Terms and abbreviations</a> on page 112).   | -                     |      |             |   |        |  |   |       |                           |   |       |                           |   |       |   |       |          |  |   |       |  |        |          |  |    |            |   |    |            |   |    |            |   |    |            |   |  |
| 06.42  | <i>LSU CW user bit 2 selection</i>   | (Only visible when supply unit control activated by 95.20)<br>Selects a binary source whose status is transmitted as bit 14 of <a href="#">06.39 Internal state machine LSU CW</a> to the supply unit.  | <i>MCW user bit 2</i> |      |             |   |        |  |   |       |                           |   |       |                           |   |       |   |       |          |  |   |       |  |        |          |  |    |            |   |    |            |   |    |            |   |    |            |   |  |
|        | False                                | 0.  | 0                     |      |             |   |        |  |   |       |                           |   |       |                           |   |       |   |       |          |  |   |       |  |        |          |  |    |            |   |    |            |   |    |            |   |    |            |   |  |
|        | True                                 | 1.  | 1                     |      |             |   |        |  |   |       |                           |   |       |                           |   |       |   |       |          |  |   |       |  |        |          |  |    |            |   |    |            |   |    |            |   |    |            |   |  |

| No.                   | Name/Value                                       | Description  | Def/FbEq16                     |
|-----------------------|--|--|--------------------------------|
|                       | MCW user bit 0                                   | Bit 12 of <a href="#">06.01 Main control word</a> (see page <a href="#">128</a> ).   | 2                              |
|                       | MCW user bit 1                                   | Bit 13 of <a href="#">06.01 Main control word</a> (see page <a href="#">128</a> ).   | 3                              |
|                       | MCW user bit 2                                   | Bit 14 of <a href="#">06.01 Main control word</a> (see page <a href="#">128</a> ).   | 4                              |
|                       | MCW user bit 3                                   | Bit 15 of <a href="#">06.01 Main control word</a> (see page <a href="#">128</a> ).   | 5                              |
|                       | <i>Other [bit]</i>                               | Source selection (see <a href="#">Terms and abbreviations</a> on page <a href="#">112</a> ).   | -                              |
| <a href="#">06.43</a> | <a href="#">LSU CW user bit 3 selection</a>      | (Only visible when supply unit control activated by <a href="#">95.20</a> )<br>Selects a binary source whose status is transmitted as bit 15 of <a href="#">06.39 Internal state machine LSU CW</a> to the supply unit.  | <a href="#">MCW user bit 3</a> |
|                       | False  | 0.   | 0                              |
|                       | True   | 1.   | 1                              |
|                       | MCW user bit 0                                   | Bit 12 of <a href="#">06.01 Main control word</a> (see page <a href="#">128</a> ).   | 2                              |
|                       | MCW user bit 1                                   | Bit 13 of <a href="#">06.01 Main control word</a> (see page <a href="#">128</a> ).   | 3                              |
|                       | MCW user bit 2                                   | Bit 14 of <a href="#">06.01 Main control word</a> (see page <a href="#">128</a> ).   | 4                              |
|                       | MCW user bit 3                                   | Bit 15 of <a href="#">06.01 Main control word</a> (see page <a href="#">128</a> ).   | 5                              |
|                       | <i>Other [bit]</i>                               | Source selection (see <a href="#">Terms and abbreviations</a> on page <a href="#">112</a> ).   | -                              |
| <a href="#">06.45</a> | <a href="#">Follower CW user bit 0 selection</a> | Selects a binary source whose status is transmitted as bit 12 of the Follower control word to follower drives. (Bits 0...11 of the Follower control word are taken from <a href="#">06.01 Main control word</a> .)<br>See also section <a href="#">Master/follower functionality</a> (page <a href="#">31</a> ). | <a href="#">MCW user bit 0</a> |
|                       | False  | 0.   | 0                              |
|                       | True   | 1.   | 1                              |
|                       | MCW user bit 0                                   | Bit 12 of <a href="#">06.01 Main control word</a> (see page <a href="#">128</a> ).   | 2                              |
|                       | MCW user bit 1                                   | Bit 13 of <a href="#">06.01 Main control word</a> (see page <a href="#">128</a> ).   | 3                              |
|                       | MCW user bit 2                                   | Bit 14 of <a href="#">06.01 Main control word</a> (see page <a href="#">128</a> ).   | 4                              |
|                       | MCW user bit 3                                   | Bit 15 of <a href="#">06.01 Main control word</a> (see page <a href="#">128</a> ).   | 5                              |
|                       | <i>Other [bit]</i>                               | Source selection (see <a href="#">Terms and abbreviations</a> on page <a href="#">112</a> ).   | -                              |
| <a href="#">06.46</a> | <a href="#">Follower CW user bit 1 selection</a> | Selects a binary source whose status is transmitted as bit 13 of the Follower control word to follower drives. (Bits 0...11 of the Follower control word are taken from <a href="#">06.01 Main control word</a> .)   | <a href="#">MCW user bit 1</a> |
|                       | False  | 0.   | 0                              |
|                       | True   | 1.   | 1                              |
|                       | MCW user bit 0                                   | Bit 12 of <a href="#">06.01 Main control word</a> (see page <a href="#">128</a> ).   | 2                              |
|                       | MCW user bit 1                                   | Bit 13 of <a href="#">06.01 Main control word</a> (see page <a href="#">128</a> ).   | 3                              |
|                       | MCW user bit 2                                   | Bit 14 of <a href="#">06.01 Main control word</a> (see page <a href="#">128</a> ).   | 4                              |
|                       | MCW user bit 3                                   | Bit 15 of <a href="#">06.01 Main control word</a> (see page <a href="#">128</a> ).   | 5                              |
|                       | <i>Other [bit]</i>                               | Source selection (see <a href="#">Terms and abbreviations</a> on page <a href="#">112</a> ).   | -                              |
| <a href="#">06.47</a> | <a href="#">Follower CW user bit 2 selection</a> | Selects a binary source whose status is transmitted as bit 14 of the Follower control word to follower drives. (Bits 0...11 of the Follower control word are taken from <a href="#">06.01 Main control word</a> .)   | <a href="#">MCW user bit 2</a> |
|                       | False  | 0.   | 0                              |
|                       | True   | 1.   | 1                              |
|                       | MCW user bit 0                                   | Bit 12 of <a href="#">06.01 Main control word</a> (see page <a href="#">128</a> ).   | 2                              |

| No.   | Name/Value                                       | Description  | Def/FbEq16                            |     |      |             |   |                   |  |   |                   |  |     |     |     |    |                    |  |
|---|--|--|---------------------------------------|-----|------|-------------|---|-------------------|--|---|-------------------|--|-----|-----|-----|----|--------------------|--|
|   | MCW user bit 1                                   | Bit 13 of <a href="#">06.01 Main control word</a> (see page 128).  | 3                                     |     |      |             |   |                   |  |   |                   |  |     |     |     |    |                    |  |
|   | MCW user bit 2                                   | Bit 14 of <a href="#">06.01 Main control word</a> (see page 128).  | 4                                     |     |      |             |   |                   |  |   |                   |  |     |     |     |    |                    |  |
|   | MCW user bit 3                                   | Bit 15 of <a href="#">06.01 Main control word</a> (see page 128).  | 5                                     |     |      |             |   |                   |  |   |                   |  |     |     |     |    |                    |  |
|   | <a href="#">Other [bit]</a>                      | Source selection (see <a href="#">Terms and abbreviations</a> on page 112).  | -                                     |     |      |             |   |                   |  |   |                   |  |     |     |     |    |                    |  |
| <a href="#">06.48</a>   | <a href="#">Follower CW user bit 3 selection</a> | Selects a binary source whose status is transmitted as bit 15 of the Follower control word to follower drives. (Bits 0...11 of the Follower control word are taken from <a href="#">06.01 Main control word</a> .) | <a href="#">MCW user bit 3</a>        |     |      |             |   |                   |  |   |                   |  |     |     |     |    |                    |  |
|   | False  | 0.   | 0                                     |     |      |             |   |                   |  |   |                   |  |     |     |     |    |                    |  |
|   | True   | 1.   | 1                                     |     |      |             |   |                   |  |   |                   |  |     |     |     |    |                    |  |
|   | MCW user bit 0                                   | Bit 12 of <a href="#">06.01 Main control word</a> (see page 128).  | 2                                     |     |      |             |   |                   |  |   |                   |  |     |     |     |    |                    |  |
|   | MCW user bit 1                                   | Bit 13 of <a href="#">06.01 Main control word</a> (see page 128).  | 3                                     |     |      |             |   |                   |  |   |                   |  |     |     |     |    |                    |  |
|   | MCW user bit 2                                   | Bit 14 of <a href="#">06.01 Main control word</a> (see page 128).  | 4                                     |     |      |             |   |                   |  |   |                   |  |     |     |     |    |                    |  |
|   | MCW user bit 3                                   | Bit 15 of <a href="#">06.01 Main control word</a> (see page 128).  | 5                                     |     |      |             |   |                   |  |   |                   |  |     |     |     |    |                    |  |
|   | <a href="#">Other [bit]</a>                      | Source selection (see <a href="#">Terms and abbreviations</a> on page 112).  | -                                     |     |      |             |   |                   |  |   |                   |  |     |     |     |    |                    |  |
| <a href="#">06.50</a>   | <a href="#">User status word 1</a>               | User-defined status word. This word shows the status of the binary sources selected by parameters <a href="#">06.60</a> ... <a href="#">06.75</a> . This parameter is read-only.                                   | -                                     |     |      |             |   |                   |  |   |                   |  |     |     |     |    |                    |  |
| <table border="1"> <thead> <tr> <th>Bit</th> <th>Name</th> <th>Description</th> </tr> </thead> <tbody> <tr> <td>0</td> <td>User status bit 0</td> <td>Status of source selected by parameter <a href="#">06.60</a></td> </tr> <tr> <td>1</td> <td>User status bit 1</td> <td>Status of source selected by parameter <a href="#">06.61</a></td> </tr> <tr> <td>...</td> <td>...</td> <td>...</td> </tr> <tr> <td>15</td> <td>User status bit 15</td> <td>Status of source selected by parameter <a href="#">06.75</a></td> </tr> </tbody> </table> |  |  |                                       | Bit | Name | Description | 0 | User status bit 0 | Status of source selected by parameter <a href="#">06.60</a> | 1 | User status bit 1 | Status of source selected by parameter <a href="#">06.61</a> | ... | ... | ... | 15 | User status bit 15 | Status of source selected by parameter <a href="#">06.75</a> |
| Bit   | Name   | Description  |                                       |     |      |             |   |                   |  |   |                   |  |     |     |     |    |                    |  |
| 0   | User status bit 0                                | Status of source selected by parameter <a href="#">06.60</a>   |                                       |     |      |             |   |                   |  |   |                   |  |     |     |     |    |                    |  |
| 1   | User status bit 1                                | Status of source selected by parameter <a href="#">06.61</a>   |                                       |     |      |             |   |                   |  |   |                   |  |     |     |     |    |                    |  |
| ...   | ...  | ...  |                                       |     |      |             |   |                   |  |   |                   |  |     |     |     |    |                    |  |
| 15  | User status bit 15                               | Status of source selected by parameter <a href="#">06.75</a>   |                                       |     |      |             |   |                   |  |   |                   |  |     |     |     |    |                    |  |
|   | 0000h...FFFFh                                    | User-defined status word.  | 1 = 1                                 |     |      |             |   |                   |  |   |                   |  |     |     |     |    |                    |  |
| <a href="#">06.60</a>   | <a href="#">User status word 1 bit 0 sel</a>     | Selects a binary source whose status is shown as bit 0 of <a href="#">06.50 User status word 1</a> .   | <a href="#">False</a>                 |     |      |             |   |                   |  |   |                   |  |     |     |     |    |                    |  |
|   | False  | 0.   | 0                                     |     |      |             |   |                   |  |   |                   |  |     |     |     |    |                    |  |
|   | True   | 1.   | 1                                     |     |      |             |   |                   |  |   |                   |  |     |     |     |    |                    |  |
|   | <a href="#">Other [bit]</a>                      | Source selection (see <a href="#">Terms and abbreviations</a> on page 112).  | -                                     |     |      |             |   |                   |  |   |                   |  |     |     |     |    |                    |  |
| <a href="#">06.61</a>   | <a href="#">User status word 1 bit 1 sel</a>     | Selects a binary source whose status is shown as bit 1 of <a href="#">06.50 User status word 1</a> .   | <a href="#">Out of window</a>         |     |      |             |   |                   |  |   |                   |  |     |     |     |    |                    |  |
|   | False  | 0.   | 0                                     |     |      |             |   |                   |  |   |                   |  |     |     |     |    |                    |  |
|   | True   | 1.   | 1                                     |     |      |             |   |                   |  |   |                   |  |     |     |     |    |                    |  |
|   | Out of window                                    | Bit 3 of <a href="#">06.19 Speed control status word</a> (see page 133).   | 2                                     |     |      |             |   |                   |  |   |                   |  |     |     |     |    |                    |  |
|   | <a href="#">Other [bit]</a>                      | Source selection (see <a href="#">Terms and abbreviations</a> on page 112).  | -                                     |     |      |             |   |                   |  |   |                   |  |     |     |     |    |                    |  |
| <a href="#">06.62</a>   | <a href="#">User status word 1 bit 2 sel</a>     | Selects a binary source whose status is shown as bit 2 of <a href="#">06.50 User status word 1</a> .   | <a href="#">Emergency stop failed</a> |     |      |             |   |                   |  |   |                   |  |     |     |     |    |                    |  |
|   | False  | 0.   | 0                                     |     |      |             |   |                   |  |   |                   |  |     |     |     |    |                    |  |
|   | True   | 1.   | 1                                     |     |      |             |   |                   |  |   |                   |  |     |     |     |    |                    |  |
|   | Emergency stop failed                            | Bit 8 of <a href="#">06.17 Drive status word 2</a> (see page 131).   | 2                                     |     |      |             |   |                   |  |   |                   |  |     |     |     |    |                    |  |
|   | <a href="#">Other [bit]</a>                      | Source selection (see <a href="#">Terms and abbreviations</a> on page 112).  | -                                     |     |      |             |   |                   |  |   |                   |  |     |     |     |    |                    |  |

## 140 Parameters

| No.   | Name/Value                           | Description  | Def/FbEq16                     |
|-------|--------------------------------------|--|--------------------------------|
| 06.63 | <i>User status word 1 bit 3 sel</i>  | Selects a binary source whose status is shown as bit 3 of <i>06.50 User status word 1</i> .  | <i>Magnetized</i>              |
|       | False                                | 0.   | 0                              |
|       | True                                 | 1.   | 1                              |
|       | Magnetized                           | Bit 1 of <i>06.17 Drive status word 2</i> (see page 131).                                    | 2                              |
|       | <i>Other [bit]</i>                   | Source selection (see <i>Terms and abbreviations</i> on page 112).                           | -                              |
| 06.64 | <i>User status word 1 bit 4 sel</i>  | Selects a binary source whose status is shown as bit 4 of <i>06.50 User status word 1</i> .  | <i>Run disable</i>             |
|       | False                                | 0.   | 0                              |
|       | True                                 | 1.   | 1                              |
|       | Run disable                          | Bit 5 of <i>06.18 Start inhibit status word</i> (see page 132).                              | 2                              |
|       | <i>Other [bit]</i>                   | Source selection (see <i>Terms and abbreviations</i> on page 112).                           | -                              |
| 06.65 | <i>User status word 1 bit 5 sel</i>  | Selects a binary source whose status is shown as bit 5 of <i>06.50 User status word 1</i> .  | <i>False</i>                   |
|       | False                                | 0.   | 0                              |
|       | True                                 | 1.   | 1                              |
|       | <i>Other [bit]</i>                   | Source selection (see <i>Terms and abbreviations</i> on page 112).                           | -                              |
| 06.66 | <i>User status word 1 bit 6 sel</i>  | Selects a binary source whose status is shown as bit 6 of <i>06.50 User status word 1</i> .  | <i>False</i>                   |
|       | False                                | 0.   | 0                              |
|       | True                                 | 1.   | 1                              |
|       | <i>Other [bit]</i>                   | Source selection (see <i>Terms and abbreviations</i> on page 112).                           | -                              |
| 06.67 | <i>User status word 1 bit 7 sel</i>  | Selects a binary source whose status is shown as bit 7 of <i>06.50 User status word 1</i> .  | <i>Identification run done</i> |
|       | False                                | 0.   | 0                              |
|       | True                                 | 1.   | 1                              |
|       | Identification run done              | Bit 0 of <i>06.17 Drive status word 2</i> (see page 131).                                    | 2                              |
|       | <i>Other [bit]</i>                   | Source selection (see <i>Terms and abbreviations</i> on page 112).                           | -                              |
| 06.68 | <i>User status word 1 bit 8 sel</i>  | Selects a binary source whose status is shown as bit 8 of <i>06.50 User status word 1</i> .  | <i>Start inhibition</i>        |
|       | False                                | 0.   | 0                              |
|       | True                                 | 1.   | 1                              |
|       | Start inhibition                     | Bit 7 of <i>06.18 Start inhibit status word</i> (see page 132).                              | 2                              |
|       | <i>Other [bit]</i>                   | Source selection (see <i>Terms and abbreviations</i> on page 112).                           | -                              |
| 06.69 | <i>User status word 1 bit 9 sel</i>  | Selects a binary source whose status is shown as bit 9 of <i>06.50 User status word 1</i> .  | <i>Limiting</i>                |
|       | False                                | 0.   | 0                              |
|       | True                                 | 1.   | 1                              |
|       | Limiting                             | Bit 7 of <i>06.16 Drive status word 1</i> (see page 130).                                    | 2                              |
|       | <i>Other [bit]</i>                   | Source selection (see <i>Terms and abbreviations</i> on page 112).                           | -                              |
| 06.70 | <i>User status word 1 bit 10 sel</i> | Selects a binary source whose status is shown as bit 10 of <i>06.50 User status word 1</i> . | <i>Torque control</i>          |
|       | False                                | 0.   | 0                              |

| No.  | Name/Value                                    | Description   | Def/FbEq16                              |     |      |             |   |                           |                   |   |                           |                   |     |     |     |    |                            |                   |
|--|---|---|---|-----|------|-------------|---|---------------------------|-------------------|---|---------------------------|-------------------|-----|-----|-----|----|----------------------------|-------------------|
|  | True  | 1.  | 1                                       |     |      |             |   |                           |                   |   |                           |                   |     |     |     |    |                            |                   |
|  | Torque control                                | Bit 2 of <a href="#">06.17 Drive status word 2</a> (see page <a href="#">131</a> ).                   | 2                                       |     |      |             |   |                           |                   |   |                           |                   |     |     |     |    |                            |                   |
|  | <i>Other [bit]</i>                            | Source selection (see <a href="#">Terms and abbreviations</a> on page <a href="#">112</a> ).          | -                                       |     |      |             |   |                           |                   |   |                           |                   |     |     |     |    |                            |                   |
| <a href="#">06.71</a>  | <a href="#">User status word 1 bit 11 sel</a> | Selects a binary source whose status is shown as bit 11 of <a href="#">06.50 User status word 1</a> . | <a href="#">Zero speed</a>              |     |      |             |   |                           |                   |   |                           |                   |     |     |     |    |                            |                   |
|  | False   | 0.  | 0                                       |     |      |             |   |                           |                   |   |                           |                   |     |     |     |    |                            |                   |
|  | True  | 1.  | 1                                       |     |      |             |   |                           |                   |   |                           |                   |     |     |     |    |                            |                   |
|  | Zero speed                                    | Bit 0 of <a href="#">06.19 Speed control status word</a> (see page <a href="#">133</a> ).             | 2                                       |     |      |             |   |                           |                   |   |                           |                   |     |     |     |    |                            |                   |
|  | <i>Other [bit]</i>                            | Source selection (see <a href="#">Terms and abbreviations</a> on page <a href="#">112</a> ).          | -                                       |     |      |             |   |                           |                   |   |                           |                   |     |     |     |    |                            |                   |
| <a href="#">06.72</a>  | <a href="#">User status word 1 bit 12 sel</a> | Selects a binary source whose status is shown as bit 12 of <a href="#">06.50 User status word 1</a> . | <a href="#">Internal speed feedback</a> |     |      |             |   |                           |                   |   |                           |                   |     |     |     |    |                            |                   |
|  | False   | 0.  | 0                                       |     |      |             |   |                           |                   |   |                           |                   |     |     |     |    |                            |                   |
|  | True  | 1.  | 1                                       |     |      |             |   |                           |                   |   |                           |                   |     |     |     |    |                            |                   |
|  | Internal speed feedback                       | Bit 4 of <a href="#">06.19 Speed control status word</a> (see page <a href="#">133</a> ).             | 2                                       |     |      |             |   |                           |                   |   |                           |                   |     |     |     |    |                            |                   |
|  | <i>Other [bit]</i>                            | Source selection (see <a href="#">Terms and abbreviations</a> on page <a href="#">112</a> ).          | -                                       |     |      |             |   |                           |                   |   |                           |                   |     |     |     |    |                            |                   |
| <a href="#">06.73</a>  | <a href="#">User status word 1 bit 13 sel</a> | Selects a binary source whose status is shown as bit 13 of <a href="#">06.50 User status word 1</a> . | <a href="#">False</a>                   |     |      |             |   |                           |                   |   |                           |                   |     |     |     |    |                            |                   |
|  | False   | 0.  | 0                                       |     |      |             |   |                           |                   |   |                           |                   |     |     |     |    |                            |                   |
|  | True  | 1.  | 1                                       |     |      |             |   |                           |                   |   |                           |                   |     |     |     |    |                            |                   |
|  | <i>Other [bit]</i>                            | Source selection (see <a href="#">Terms and abbreviations</a> on page <a href="#">112</a> ).          | -                                       |     |      |             |   |                           |                   |   |                           |                   |     |     |     |    |                            |                   |
| <a href="#">06.74</a>  | <a href="#">User status word 1 bit 14 sel</a> | Selects a binary source whose status is shown as bit 14 of <a href="#">06.50 User status word 1</a> . | <a href="#">False</a>                   |     |      |             |   |                           |                   |   |                           |                   |     |     |     |    |                            |                   |
|  | False   | 0.  | 0                                       |     |      |             |   |                           |                   |   |                           |                   |     |     |     |    |                            |                   |
|  | True  | 1.  | 1                                       |     |      |             |   |                           |                   |   |                           |                   |     |     |     |    |                            |                   |
|  | <i>Other [bit]</i>                            | Source selection (see <a href="#">Terms and abbreviations</a> on page <a href="#">112</a> ).          | -                                       |     |      |             |   |                           |                   |   |                           |                   |     |     |     |    |                            |                   |
| <a href="#">06.75</a>  | <a href="#">User status word 1 bit 15 sel</a> | Selects a binary source whose status is shown as bit 15 of <a href="#">06.50 User status word 1</a> . | <a href="#">False</a>                   |     |      |             |   |                           |                   |   |                           |                   |     |     |     |    |                            |                   |
|  | False   | 0.  | 0                                       |     |      |             |   |                           |                   |   |                           |                   |     |     |     |    |                            |                   |
|  | True  | 1.  | 1                                       |     |      |             |   |                           |                   |   |                           |                   |     |     |     |    |                            |                   |
|  | <i>Other [bit]</i>                            | Source selection (see <a href="#">Terms and abbreviations</a> on page <a href="#">112</a> ).          | -                                       |     |      |             |   |                           |                   |   |                           |                   |     |     |     |    |                            |                   |
| <a href="#">06.100</a>   | <a href="#">User control word 1</a>           | User-defined control word 1.  | -                                       |     |      |             |   |                           |                   |   |                           |                   |     |     |     |    |                            |                   |
| <table border="1"> <thead> <tr> <th>Bit</th> <th>Name</th> <th>Description</th> </tr> </thead> <tbody> <tr> <td>0</td> <td>User control word 1 bit 0</td> <td>User-defined bit.</td> </tr> <tr> <td>1</td> <td>User control word 1 bit 1</td> <td>User-defined bit.</td> </tr> <tr> <td>...</td> <td>...</td> <td>...</td> </tr> <tr> <td>15</td> <td>User control word 1 bit 15</td> <td>User-defined bit.</td> </tr> </tbody> </table> |   |   |   | Bit | Name | Description | 0 | User control word 1 bit 0 | User-defined bit. | 1 | User control word 1 bit 1 | User-defined bit. | ... | ... | ... | 15 | User control word 1 bit 15 | User-defined bit. |
| Bit  | Name  | Description   |   |     |      |             |   |                           |                   |   |                           |                   |     |     |     |    |                            |                   |
| 0  | User control word 1 bit 0                     | User-defined bit.   |   |     |      |             |   |                           |                   |   |                           |                   |     |     |     |    |                            |                   |
| 1  | User control word 1 bit 1                     | User-defined bit.   |   |     |      |             |   |                           |                   |   |                           |                   |     |     |     |    |                            |                   |
| ...  | ...   | ...   |   |     |      |             |   |                           |                   |   |                           |                   |     |     |     |    |                            |                   |
| 15   | User control word 1 bit 15                    | User-defined bit.   |   |     |      |             |   |                           |                   |   |                           |                   |     |     |     |    |                            |                   |
|  | 0000h...FFFFh                                 | User-defined control word 1.  | 1 = 1                                   |     |      |             |   |                           |                   |   |                           |                   |     |     |     |    |                            |                   |

## 142 Parameters

| No.  | Name/Value                     | Description  | Def/FbEq16 |     |      |             |   |                           |   |   |                           |                     |     |                   |                               |    |                            |   |   |         |  |   |         |                            |   |            |  |   |          |                                   |   |               |                               |   |                 |                                 |    |             |                                  |    |             |                                  |    |                |                              |    |           |                         |         |          |  |
|--|--------------------------------|--|------------|-----|------|-------------|---|---------------------------|---|---|---------------------------|---------------------|-----|-------------------|-------------------------------|----|----------------------------|---|---|---------|--|---|---------|----------------------------|---|------------|--|---|----------|-----------------------------------|---|---------------|-------------------------------|---|-----------------|---------------------------------|----|-------------|----------------------------------|----|-------------|----------------------------------|----|----------------|------------------------------|----|-----------|-------------------------|---------|----------|--|
| 06.101   | <i>User control word 2</i>     | User-defined control word 2.   | -          |     |      |             |   |                           |   |   |                           |                     |     |                   |                               |    |                            |   |   |         |  |   |         |                            |   |            |  |   |          |                                   |   |               |                               |   |                 |                                 |    |             |                                  |    |             |                                  |    |                |                              |    |           |                         |         |          |  |
| <table border="1"> <thead> <tr> <th>Bit</th> <th>Name</th> <th>Description</th> </tr> </thead> <tbody> <tr> <td>0</td> <td>User control word 2 bit 0</td> <td>User-defined bit.</td> </tr> <tr> <td>1</td> <td>User control word 2 bit 1</td> <td>User-defined bit.</td> </tr> <tr> <td>...</td> <td>...</td> <td>...</td> </tr> <tr> <td>15</td> <td>User control word 2 bit 15</td> <td>User-defined bit.</td> </tr> </tbody> </table>   |                                |  |            | Bit | Name | Description | 0 | User control word 2 bit 0 | User-defined bit.                                   | 1 | User control word 2 bit 1 | User-defined bit.   | ... | ...               | ...                           | 15 | User control word 2 bit 15 | User-defined bit.                             |   |         |  |   |         |                            |   |            |  |   |          |                                   |   |               |                               |   |                 |                                 |    |             |                                  |    |             |                                  |    |                |                              |    |           |                         |         |          |  |
| Bit  | Name                           | Description  |            |     |      |             |   |                           |   |   |                           |                     |     |                   |                               |    |                            |   |   |         |  |   |         |                            |   |            |  |   |          |                                   |   |               |                               |   |                 |                                 |    |             |                                  |    |             |                                  |    |                |                              |    |           |                         |         |          |  |
| 0  | User control word 2 bit 0      | User-defined bit.  |            |     |      |             |   |                           |   |   |                           |                     |     |                   |                               |    |                            |   |   |         |  |   |         |                            |   |            |  |   |          |                                   |   |               |                               |   |                 |                                 |    |             |                                  |    |             |                                  |    |                |                              |    |           |                         |         |          |  |
| 1  | User control word 2 bit 1      | User-defined bit.  |            |     |      |             |   |                           |   |   |                           |                     |     |                   |                               |    |                            |   |   |         |  |   |         |                            |   |            |  |   |          |                                   |   |               |                               |   |                 |                                 |    |             |                                  |    |             |                                  |    |                |                              |    |           |                         |         |          |  |
| ...  | ...                            | ...  |            |     |      |             |   |                           |   |   |                           |                     |     |                   |                               |    |                            |   |   |         |  |   |         |                            |   |            |  |   |          |                                   |   |               |                               |   |                 |                                 |    |             |                                  |    |             |                                  |    |                |                              |    |           |                         |         |          |  |
| 15   | User control word 2 bit 15     | User-defined bit.  |            |     |      |             |   |                           |   |   |                           |                     |     |                   |                               |    |                            |   |   |         |  |   |         |                            |   |            |  |   |          |                                   |   |               |                               |   |                 |                                 |    |             |                                  |    |             |                                  |    |                |                              |    |           |                         |         |          |  |
| 0000h...FFFFh  |                                | User-defined control word 2.   | 1 = 1      |     |      |             |   |                           |   |   |                           |                     |     |                   |                               |    |                            |   |   |         |  |   |         |                            |   |            |  |   |          |                                   |   |               |                               |   |                 |                                 |    |             |                                  |    |             |                                  |    |                |                              |    |           |                         |         |          |  |
| 06.116   | <i>LSU drive status word 1</i> | <p><i>(Only visible when IGBT supply unit control activated by 95.20)</i></p> <p>Drive status word 1 received from the supply unit.<br/>See also section <i>Control of a supply unit (LSU)</i> (page 40), and parameter group <i>60 DDCS communication</i>.<br/>This parameter is read-only.</p> | -          |     |      |             |   |                           |   |   |                           |                     |     |                   |                               |    |                            |   |   |         |  |   |         |                            |   |            |  |   |          |                                   |   |               |                               |   |                 |                                 |    |             |                                  |    |             |                                  |    |                |                              |    |           |                         |         |          |  |
| <table border="1"> <thead> <tr> <th>Bit</th> <th>Name</th> <th>Description</th> </tr> </thead> <tbody> <tr> <td>0</td> <td>Enabled</td> <td>1 = Run enable and start enable signals are present</td> </tr> <tr> <td>1</td> <td>Inhibited</td> <td>1 = Start inhibited</td> </tr> <tr> <td>2</td> <td>Operation allowed</td> <td>1 = Drive is ready to operate</td> </tr> <tr> <td>3</td> <td>Ready to start</td> <td>1 = Drive is ready to receive a start command</td> </tr> <tr> <td>4</td> <td>Running</td> <td>1 = Drive is ready to follow given reference</td> </tr> <tr> <td>5</td> <td>Started</td> <td>1 = Drive has been started</td> </tr> <tr> <td>6</td> <td>Modulating</td> <td>1 = Drive is modulating (output stage is being controlled)</td> </tr> <tr> <td>7</td> <td>Limiting</td> <td>1 = Any operating limit is active</td> </tr> <tr> <td>8</td> <td>Local control</td> <td>1 = Drive is in local control</td> </tr> <tr> <td>9</td> <td>Network control</td> <td>1 = Drive is in network control</td> </tr> <tr> <td>10</td> <td>Ext1 active</td> <td>1 = Control location Ext1 active</td> </tr> <tr> <td>11</td> <td>Ext2 active</td> <td>1 = Control location Ext2 active</td> </tr> <tr> <td>12</td> <td>Charging relay</td> <td>1 = Charging relay is closed</td> </tr> <tr> <td>13</td> <td>MCB relay</td> <td>1 = MCB relay is closed</td> </tr> <tr> <td>14...15</td> <td>Reserved</td> <td></td> </tr> </tbody> </table> |                                |  |            | Bit | Name | Description | 0 | Enabled                   | 1 = Run enable and start enable signals are present | 1 | Inhibited                 | 1 = Start inhibited | 2   | Operation allowed | 1 = Drive is ready to operate | 3  | Ready to start             | 1 = Drive is ready to receive a start command | 4 | Running | 1 = Drive is ready to follow given reference | 5 | Started | 1 = Drive has been started | 6 | Modulating | 1 = Drive is modulating (output stage is being controlled) | 7 | Limiting | 1 = Any operating limit is active | 8 | Local control | 1 = Drive is in local control | 9 | Network control | 1 = Drive is in network control | 10 | Ext1 active | 1 = Control location Ext1 active | 11 | Ext2 active | 1 = Control location Ext2 active | 12 | Charging relay | 1 = Charging relay is closed | 13 | MCB relay | 1 = MCB relay is closed | 14...15 | Reserved |  |
| Bit  | Name                           | Description  |            |     |      |             |   |                           |   |   |                           |                     |     |                   |                               |    |                            |   |   |         |  |   |         |                            |   |            |  |   |          |                                   |   |               |                               |   |                 |                                 |    |             |                                  |    |             |                                  |    |                |                              |    |           |                         |         |          |  |
| 0  | Enabled                        | 1 = Run enable and start enable signals are present  |            |     |      |             |   |                           |   |   |                           |                     |     |                   |                               |    |                            |   |   |         |  |   |         |                            |   |            |  |   |          |                                   |   |               |                               |   |                 |                                 |    |             |                                  |    |             |                                  |    |                |                              |    |           |                         |         |          |  |
| 1  | Inhibited                      | 1 = Start inhibited  |            |     |      |             |   |                           |   |   |                           |                     |     |                   |                               |    |                            |   |   |         |  |   |         |                            |   |            |  |   |          |                                   |   |               |                               |   |                 |                                 |    |             |                                  |    |             |                                  |    |                |                              |    |           |                         |         |          |  |
| 2  | Operation allowed              | 1 = Drive is ready to operate  |            |     |      |             |   |                           |   |   |                           |                     |     |                   |                               |    |                            |   |   |         |  |   |         |                            |   |            |  |   |          |                                   |   |               |                               |   |                 |                                 |    |             |                                  |    |             |                                  |    |                |                              |    |           |                         |         |          |  |
| 3  | Ready to start                 | 1 = Drive is ready to receive a start command  |            |     |      |             |   |                           |   |   |                           |                     |     |                   |                               |    |                            |   |   |         |  |   |         |                            |   |            |  |   |          |                                   |   |               |                               |   |                 |                                 |    |             |                                  |    |             |                                  |    |                |                              |    |           |                         |         |          |  |
| 4  | Running                        | 1 = Drive is ready to follow given reference   |            |     |      |             |   |                           |   |   |                           |                     |     |                   |                               |    |                            |   |   |         |  |   |         |                            |   |            |  |   |          |                                   |   |               |                               |   |                 |                                 |    |             |                                  |    |             |                                  |    |                |                              |    |           |                         |         |          |  |
| 5  | Started                        | 1 = Drive has been started   |            |     |      |             |   |                           |   |   |                           |                     |     |                   |                               |    |                            |   |   |         |  |   |         |                            |   |            |  |   |          |                                   |   |               |                               |   |                 |                                 |    |             |                                  |    |             |                                  |    |                |                              |    |           |                         |         |          |  |
| 6  | Modulating                     | 1 = Drive is modulating (output stage is being controlled)   |            |     |      |             |   |                           |   |   |                           |                     |     |                   |                               |    |                            |   |   |         |  |   |         |                            |   |            |  |   |          |                                   |   |               |                               |   |                 |                                 |    |             |                                  |    |             |                                  |    |                |                              |    |           |                         |         |          |  |
| 7  | Limiting                       | 1 = Any operating limit is active  |            |     |      |             |   |                           |   |   |                           |                     |     |                   |                               |    |                            |   |   |         |  |   |         |                            |   |            |  |   |          |                                   |   |               |                               |   |                 |                                 |    |             |                                  |    |             |                                  |    |                |                              |    |           |                         |         |          |  |
| 8  | Local control                  | 1 = Drive is in local control  |            |     |      |             |   |                           |   |   |                           |                     |     |                   |                               |    |                            |   |   |         |  |   |         |                            |   |            |  |   |          |                                   |   |               |                               |   |                 |                                 |    |             |                                  |    |             |                                  |    |                |                              |    |           |                         |         |          |  |
| 9  | Network control                | 1 = Drive is in network control  |            |     |      |             |   |                           |   |   |                           |                     |     |                   |                               |    |                            |   |   |         |  |   |         |                            |   |            |  |   |          |                                   |   |               |                               |   |                 |                                 |    |             |                                  |    |             |                                  |    |                |                              |    |           |                         |         |          |  |
| 10   | Ext1 active                    | 1 = Control location Ext1 active   |            |     |      |             |   |                           |   |   |                           |                     |     |                   |                               |    |                            |   |   |         |  |   |         |                            |   |            |  |   |          |                                   |   |               |                               |   |                 |                                 |    |             |                                  |    |             |                                  |    |                |                              |    |           |                         |         |          |  |
| 11   | Ext2 active                    | 1 = Control location Ext2 active   |            |     |      |             |   |                           |   |   |                           |                     |     |                   |                               |    |                            |   |   |         |  |   |         |                            |   |            |  |   |          |                                   |   |               |                               |   |                 |                                 |    |             |                                  |    |             |                                  |    |                |                              |    |           |                         |         |          |  |
| 12   | Charging relay                 | 1 = Charging relay is closed   |            |     |      |             |   |                           |   |   |                           |                     |     |                   |                               |    |                            |   |   |         |  |   |         |                            |   |            |  |   |          |                                   |   |               |                               |   |                 |                                 |    |             |                                  |    |             |                                  |    |                |                              |    |           |                         |         |          |  |
| 13   | MCB relay                      | 1 = MCB relay is closed  |            |     |      |             |   |                           |   |   |                           |                     |     |                   |                               |    |                            |   |   |         |  |   |         |                            |   |            |  |   |          |                                   |   |               |                               |   |                 |                                 |    |             |                                  |    |             |                                  |    |                |                              |    |           |                         |         |          |  |
| 14...15  | Reserved                       |  |            |     |      |             |   |                           |   |   |                           |                     |     |                   |                               |    |                            |   |   |         |  |   |         |                            |   |            |  |   |          |                                   |   |               |                               |   |                 |                                 |    |             |                                  |    |             |                                  |    |                |                              |    |           |                         |         |          |  |
| 0000h...FFFFh  |                                | Drive status word 1.   | 1 = 1      |     |      |             |   |                           |   |   |                           |                     |     |                   |                               |    |                            |   |   |         |  |   |         |                            |   |            |  |   |          |                                   |   |               |                               |   |                 |                                 |    |             |                                  |    |             |                                  |    |                |                              |    |           |                         |         |          |  |

| No.                   | Name/Value                           | Description   | Def/FbEq16 |      |   |               |   |                       |   |             |   |             |   |                   |   |                 |       |          |   |                   |         |          |    |         |    |         |    |                    |    |          |   |
|-----------------------|--------------------------------------|---|------------|------|---|---------------|---|-----------------------|---|-------------|---|-------------|---|-------------------|---|-----------------|-------|----------|---|-------------------|---------|----------|----|---------|----|---------|----|--------------------|----|----------|---|
| 06.118                | <i>LSU start inhibit status word</i> | <p>(Only visible when IGBT supply unit control activated by 95.20)</p> <p>This word specifies the source of the inhibiting condition that is preventing the supply unit from starting. See also section <i>Control of a supply unit (LSU)</i> (page 40), and parameter group <i>60 DDCS communication</i>. This parameter is read-only.</p> <table border="1"> <thead> <tr> <th>Bit</th> <th>Name</th> </tr> </thead> <tbody> <tr><td>0</td><td>Not ready run</td></tr> <tr><td>1</td><td>Ctrl location changed</td></tr> <tr><td>2</td><td>SSW inhibit</td></tr> <tr><td>3</td><td>Fault reset</td></tr> <tr><td>4</td><td>Lost start enable</td></tr> <tr><td>5</td><td>Lost run enable</td></tr> <tr><td>6...8</td><td>Reserved</td></tr> <tr><td>9</td><td>Charging overload</td></tr> <tr><td>10...11</td><td>Reserved</td></tr> <tr><td>12</td><td>Em Off2</td></tr> <tr><td>13</td><td>Em Off3</td></tr> <tr><td>14</td><td>Auto reset inhibit</td></tr> <tr><td>15</td><td>Reserved</td></tr> </tbody> </table> | Bit        | Name | 0 | Not ready run | 1 | Ctrl location changed | 2 | SSW inhibit | 3 | Fault reset | 4 | Lost start enable | 5 | Lost run enable | 6...8 | Reserved | 9 | Charging overload | 10...11 | Reserved | 12 | Em Off2 | 13 | Em Off3 | 14 | Auto reset inhibit | 15 | Reserved | - |
| Bit                   | Name                                 |   |            |      |   |               |   |                       |   |             |   |             |   |                   |   |                 |       |          |   |                   |         |          |    |         |    |         |    |                    |    |          |   |
| 0                     | Not ready run                        |   |            |      |   |               |   |                       |   |             |   |             |   |                   |   |                 |       |          |   |                   |         |          |    |         |    |         |    |                    |    |          |   |
| 1                     | Ctrl location changed                |   |            |      |   |               |   |                       |   |             |   |             |   |                   |   |                 |       |          |   |                   |         |          |    |         |    |         |    |                    |    |          |   |
| 2                     | SSW inhibit                          |   |            |      |   |               |   |                       |   |             |   |             |   |                   |   |                 |       |          |   |                   |         |          |    |         |    |         |    |                    |    |          |   |
| 3                     | Fault reset                          |   |            |      |   |               |   |                       |   |             |   |             |   |                   |   |                 |       |          |   |                   |         |          |    |         |    |         |    |                    |    |          |   |
| 4                     | Lost start enable                    |   |            |      |   |               |   |                       |   |             |   |             |   |                   |   |                 |       |          |   |                   |         |          |    |         |    |         |    |                    |    |          |   |
| 5                     | Lost run enable                      |   |            |      |   |               |   |                       |   |             |   |             |   |                   |   |                 |       |          |   |                   |         |          |    |         |    |         |    |                    |    |          |   |
| 6...8                 | Reserved                             |   |            |      |   |               |   |                       |   |             |   |             |   |                   |   |                 |       |          |   |                   |         |          |    |         |    |         |    |                    |    |          |   |
| 9                     | Charging overload                    |   |            |      |   |               |   |                       |   |             |   |             |   |                   |   |                 |       |          |   |                   |         |          |    |         |    |         |    |                    |    |          |   |
| 10...11               | Reserved                             |   |            |      |   |               |   |                       |   |             |   |             |   |                   |   |                 |       |          |   |                   |         |          |    |         |    |         |    |                    |    |          |   |
| 12                    | Em Off2                              |   |            |      |   |               |   |                       |   |             |   |             |   |                   |   |                 |       |          |   |                   |         |          |    |         |    |         |    |                    |    |          |   |
| 13                    | Em Off3                              |   |            |      |   |               |   |                       |   |             |   |             |   |                   |   |                 |       |          |   |                   |         |          |    |         |    |         |    |                    |    |          |   |
| 14                    | Auto reset inhibit                   |   |            |      |   |               |   |                       |   |             |   |             |   |                   |   |                 |       |          |   |                   |         |          |    |         |    |         |    |                    |    |          |   |
| 15                    | Reserved                             |   |            |      |   |               |   |                       |   |             |   |             |   |                   |   |                 |       |          |   |                   |         |          |    |         |    |         |    |                    |    |          |   |
|                       | 0000h...FFFFh                        | Start inhibit status word of supply unit.   | 1 = 1      |      |   |               |   |                       |   |             |   |             |   |                   |   |                 |       |          |   |                   |         |          |    |         |    |         |    |                    |    |          |   |
| <b>07 System info</b> |                                      | Information on drive hardware, firmware and application program.<br>All parameters in this group are read-only.   |            |      |   |               |   |                       |   |             |   |             |   |                   |   |                 |       |          |   |                   |         |          |    |         |    |         |    |                    |    |          |   |
| 07.03                 | <i>Drive rating id</i>               | Type of the drive/inverter unit.  | -          |      |   |               |   |                       |   |             |   |             |   |                   |   |                 |       |          |   |                   |         |          |    |         |    |         |    |                    |    |          |   |
| 07.04                 | <i>Firmware name</i>                 | Firmware identification.<br>The format is AINFX, where X denotes the control unit type (2 = BCU-x2, 6 = ZCU-12/14).   | -          |      |   |               |   |                       |   |             |   |             |   |                   |   |                 |       |          |   |                   |         |          |    |         |    |         |    |                    |    |          |   |
| 07.05                 | <i>Firmware version</i>              | Version number of the firmware.<br>The format is A.BB.C.D, where A = major version, B = minor version, C = patch (ie. firmware variant code), D = 0.  | -          |      |   |               |   |                       |   |             |   |             |   |                   |   |                 |       |          |   |                   |         |          |    |         |    |         |    |                    |    |          |   |
| 07.06                 | <i>Loading package name</i>          | Name of the firmware loading package.<br>The format is AINLX, where X denotes the control unit type (2 = BCU-x2, 6 = ZCU-12/14).  | -          |      |   |               |   |                       |   |             |   |             |   |                   |   |                 |       |          |   |                   |         |          |    |         |    |         |    |                    |    |          |   |
| 07.07                 | <i>Loading package version</i>       | Version number of the firmware loading package. See parameter 07.05.  | -          |      |   |               |   |                       |   |             |   |             |   |                   |   |                 |       |          |   |                   |         |          |    |         |    |         |    |                    |    |          |   |
| 07.08                 | <i>Bootloader version</i>            | Version number of the firmware bootloader.  | -          |      |   |               |   |                       |   |             |   |             |   |                   |   |                 |       |          |   |                   |         |          |    |         |    |         |    |                    |    |          |   |
| 07.11                 | <i>Cpu usage</i>                     | Microprocessor load in percent.   | -          |      |   |               |   |                       |   |             |   |             |   |                   |   |                 |       |          |   |                   |         |          |    |         |    |         |    |                    |    |          |   |
|                       | 0...100%                             | Microprocessor load.  | 1 = 1%     |      |   |               |   |                       |   |             |   |             |   |                   |   |                 |       |          |   |                   |         |          |    |         |    |         |    |                    |    |          |   |
| 07.13                 | <i>PU logic version number</i>       | Version number of the power unit logic.<br>The value of FFFF indicates that the version numbers of parallel-connected power units are different. See the drive information on the control panel.  | -          |      |   |               |   |                       |   |             |   |             |   |                   |   |                 |       |          |   |                   |         |          |    |         |    |         |    |                    |    |          |   |

| No.    | Name/Value                              | Description   | Def/FbEq16 |      |             |   |          |   |   |            |   |     |            |                     |    |            |  |        |          |  |    |                 |                              |  |
|--------|---|---|------------|------|-------------|---|----------|---|---|------------|---|-----|------------|---------------------|----|------------|--|--------|----------|--|----|-----------------|------------------------------|--|
| 07.21  | <i>Application environment status 1</i> | <i>(Only visible with option +N8010 [application programmability])</i><br>Shows which tasks of the application program are running.<br>See the <i>Drive (IEC 61131-3) application programming manual (3AUA0000127808 [English])</i> .   | -          |      |             |   |          |   |   |            |   |     |            |                     |    |            |  |        |          |  |    |                 |                              |  |
|        |   | <table border="1"> <thead> <tr> <th>Bit</th> <th>Name</th> <th>Description</th> </tr> </thead> <tbody> <tr> <td>0</td> <td>Pre task</td> <td>1 = Pre-task running.</td> </tr> <tr> <td>1</td> <td>Appl task1</td> <td>1 = Task 1 running.</td> </tr> <tr> <td>2</td> <td>Appl task2</td> <td>1 = Task 2 running.</td> </tr> <tr> <td>3</td> <td>Appl task3</td> <td>1 = Task 3 running.</td> </tr> <tr> <td>4...14</td> <td>Reserved</td> <td></td> </tr> <tr> <td>15</td> <td>Task monitoring</td> <td>1 = Task monitoring enabled.</td> </tr> </tbody> </table> | Bit        | Name | Description | 0 | Pre task | 1 = Pre-task running.                           | 1 | Appl task1 | 1 = Task 1 running.                             | 2   | Appl task2 | 1 = Task 2 running. | 3  | Appl task3 | 1 = Task 3 running.                              | 4...14 | Reserved |  | 15 | Task monitoring | 1 = Task monitoring enabled. |  |
| Bit    | Name                                    | Description   |            |      |             |   |          |   |   |            |   |     |            |                     |    |            |  |        |          |  |    |                 |                              |  |
| 0      | Pre task                                | 1 = Pre-task running.   |            |      |             |   |          |   |   |            |   |     |            |                     |    |            |  |        |          |  |    |                 |                              |  |
| 1      | Appl task1                              | 1 = Task 1 running.   |            |      |             |   |          |   |   |            |   |     |            |                     |    |            |  |        |          |  |    |                 |                              |  |
| 2      | Appl task2                              | 1 = Task 2 running.   |            |      |             |   |          |   |   |            |   |     |            |                     |    |            |  |        |          |  |    |                 |                              |  |
| 3      | Appl task3                              | 1 = Task 3 running.   |            |      |             |   |          |   |   |            |   |     |            |                     |    |            |  |        |          |  |    |                 |                              |  |
| 4...14 | Reserved                                |   |            |      |             |   |          |   |   |            |   |     |            |                     |    |            |  |        |          |  |    |                 |                              |  |
| 15     | Task monitoring                         | 1 = Task monitoring enabled.  |            |      |             |   |          |   |   |            |   |     |            |                     |    |            |  |        |          |  |    |                 |                              |  |
|        | 0000h...FFFFh                           | Application program task status.  | 1 = 1      |      |             |   |          |   |   |            |   |     |            |                     |    |            |  |        |          |  |    |                 |                              |  |
| 07.22  | <i>Application environment status 2</i> | <i>(Only visible with option +N8010 [application programmability])</i><br>Shows the status of the openings in the application program.<br>See the <i>Drive (IEC 61131-3) application programming manual (3AUA0000127808 [English])</i> .  | -          |      |             |   |          |   |   |            |   |     |            |                     |    |            |  |        |          |  |    |                 |                              |  |
|        |   | <table border="1"> <thead> <tr> <th>Bit</th> <th>Name</th> <th>Description</th> </tr> </thead> <tbody> <tr> <td>0</td> <td>Opening1</td> <td>Status of opening 1 in the application program.</td> </tr> <tr> <td>1</td> <td>Opening2</td> <td>Status of opening 2 in the application program.</td> </tr> <tr> <td>...</td> <td>...</td> <td>...</td> </tr> <tr> <td>15</td> <td>Opening16</td> <td>Status of opening 16 in the application program.</td> </tr> </tbody> </table>  | Bit        | Name | Description | 0 | Opening1 | Status of opening 1 in the application program. | 1 | Opening2   | Status of opening 2 in the application program. | ... | ...        | ...                 | 15 | Opening16  | Status of opening 16 in the application program. |        |          |  |    |                 |                              |  |
| Bit    | Name                                    | Description   |            |      |             |   |          |   |   |            |   |     |            |                     |    |            |  |        |          |  |    |                 |                              |  |
| 0      | Opening1                                | Status of opening 1 in the application program.   |            |      |             |   |          |   |   |            |   |     |            |                     |    |            |  |        |          |  |    |                 |                              |  |
| 1      | Opening2                                | Status of opening 2 in the application program.   |            |      |             |   |          |   |   |            |   |     |            |                     |    |            |  |        |          |  |    |                 |                              |  |
| ...    | ...                                     | ...   |            |      |             |   |          |   |   |            |   |     |            |                     |    |            |  |        |          |  |    |                 |                              |  |
| 15     | Opening16                               | Status of opening 16 in the application program.  |            |      |             |   |          |   |   |            |   |     |            |                     |    |            |  |        |          |  |    |                 |                              |  |
|        | 0000h...FFFFh                           | Application program opening status.   | 1 = 1      |      |             |   |          |   |   |            |   |     |            |                     |    |            |  |        |          |  |    |                 |                              |  |
| 07.23  | <i>Application name</i>                 | <i>(Only visible with option +N8010 [application programmability])</i><br>First five ASCII letters of the name given to the application program in the programming tool. The full name is visible under System info on the control panel or the Drive composer PC tool.<br>_N/A_ = None.  | -          |      |             |   |          |   |   |            |   |     |            |                     |    |            |  |        |          |  |    |                 |                              |  |
| 07.24  | <i>Application version</i>              | <i>(Only visible with option +N8010 [application programmability])</i><br>Application program version number given to the application program in the programming tool. Also visible under System info on the control panel or the Drive composer PC tool.   | -          |      |             |   |          |   |   |            |   |     |            |                     |    |            |  |        |          |  |    |                 |                              |  |
| 07.25  | <i>Customization package name</i>       | First five ASCII letters of the name given to the customization package. The full name is visible under System info on the control panel or the Drive composer PC tool.<br>_N/A_ = None.  | -          |      |             |   |          |   |   |            |   |     |            |                     |    |            |  |        |          |  |    |                 |                              |  |
| 07.26  | <i>Customization package version</i>    | Customization package version number. Also visible under System info on the control panel or the Drive composer PC tool.  | -          |      |             |   |          |   |   |            |   |     |            |                     |    |            |  |        |          |  |    |                 |                              |  |



| No.                       | Name/Value                              | Description  | Def/FbEq16 |      |             |   |             |                                  |   |         |                                      |   |           |  |   |         |                              |        |          |  |    |                |   |    |         |                               |  |
|---------------------------|---|--|------------|------|-------------|---|-------------|----------------------------------|---|---------|--------------------------------------|---|-----------|--|---|---------|------------------------------|--------|----------|--|----|----------------|---|----|---------|-------------------------------|--|
| 07.30                     | <i>Adaptive program status</i>          | Shows the status of the adaptive program.<br>See section <i>Adaptive programming</i> (page 27).  | -          |      |             |   |             |                                  |   |         |                                      |   |           |  |   |         |                              |        |          |  |    |                |   |    |         |                               |  |
|                           |   | <table border="1"> <thead> <tr> <th>Bit</th> <th>Name</th> <th>Description</th> </tr> </thead> <tbody> <tr> <td>0</td> <td>Initialized</td> <td>1 = Adaptive program initialized</td> </tr> <tr> <td>1</td> <td>Editing</td> <td>1 = Adaptive program is being edited</td> </tr> <tr> <td>2</td> <td>Edit done</td> <td>1 = Editing of adaptive program finished</td> </tr> <tr> <td>3</td> <td>Running</td> <td>1 = Adaptive program running</td> </tr> <tr> <td>4...13</td> <td>Reserved</td> <td></td> </tr> <tr> <td>14</td> <td>State changing</td> <td>1 = State change in progress in adaptive programming engine</td> </tr> <tr> <td>15</td> <td>Faulted</td> <td>1 = Error in adaptive program</td> </tr> </tbody> </table> | Bit        | Name | Description | 0 | Initialized | 1 = Adaptive program initialized | 1 | Editing | 1 = Adaptive program is being edited | 2 | Edit done | 1 = Editing of adaptive program finished | 3 | Running | 1 = Adaptive program running | 4...13 | Reserved |  | 14 | State changing | 1 = State change in progress in adaptive programming engine | 15 | Faulted | 1 = Error in adaptive program |  |
| Bit                       | Name                                    | Description  |            |      |             |   |             |                                  |   |         |                                      |   |           |  |   |         |                              |        |          |  |    |                |   |    |         |                               |  |
| 0                         | Initialized                             | 1 = Adaptive program initialized   |            |      |             |   |             |                                  |   |         |                                      |   |           |  |   |         |                              |        |          |  |    |                |   |    |         |                               |  |
| 1                         | Editing                                 | 1 = Adaptive program is being edited   |            |      |             |   |             |                                  |   |         |                                      |   |           |  |   |         |                              |        |          |  |    |                |   |    |         |                               |  |
| 2                         | Edit done                               | 1 = Editing of adaptive program finished   |            |      |             |   |             |                                  |   |         |                                      |   |           |  |   |         |                              |        |          |  |    |                |   |    |         |                               |  |
| 3                         | Running                                 | 1 = Adaptive program running   |            |      |             |   |             |                                  |   |         |                                      |   |           |  |   |         |                              |        |          |  |    |                |   |    |         |                               |  |
| 4...13                    | Reserved                                |  |            |      |             |   |             |                                  |   |         |                                      |   |           |  |   |         |                              |        |          |  |    |                |   |    |         |                               |  |
| 14                        | State changing                          | 1 = State change in progress in adaptive programming engine  |            |      |             |   |             |                                  |   |         |                                      |   |           |  |   |         |                              |        |          |  |    |                |   |    |         |                               |  |
| 15                        | Faulted                                 | 1 = Error in adaptive program  |            |      |             |   |             |                                  |   |         |                                      |   |           |  |   |         |                              |        |          |  |    |                |   |    |         |                               |  |
|                           | 0000h...FFFFh                           | Adaptive program status.   | 1 = 1      |      |             |   |             |                                  |   |         |                                      |   |           |  |   |         |                              |        |          |  |    |                |   |    |         |                               |  |
| 07.40                     | <i>IEC application Cpu usage peak</i>   | <i>(Only visible with option +N8010 [application programmability])</i><br>Displays the peak loading of the microprocessor caused by the application program. This parameter can, for example, be used to check the effect of a given application program functionality on the CPU load.<br>The value is in percent of an internal quota.<br>Can be reset from the control panel by keeping Reset depressed for over 3 seconds.   | -          |      |             |   |             |                                  |   |         |                                      |   |           |  |   |         |                              |        |          |  |    |                |   |    |         |                               |  |
|                           | 0.0 ... 100.0%                          | Peak microprocessor loading caused by application program.   | 10 = 1%    |      |             |   |             |                                  |   |         |                                      |   |           |  |   |         |                              |        |          |  |    |                |   |    |         |                               |  |
| 07.41                     | <i>IEC application Cpu load average</i> | <i>(Only visible with option +N8010 [application programmability])</i><br>Displays the average loading of the microprocessor caused by the application program. The value is in percent of an internal quota.  | -          |      |             |   |             |                                  |   |         |                                      |   |           |  |   |         |                              |        |          |  |    |                |   |    |         |                               |  |
|                           | 0.0 ... 100.0%                          | Average microprocessor loading caused by application program.  | 10 = 1%    |      |             |   |             |                                  |   |         |                                      |   |           |  |   |         |                              |        |          |  |    |                |   |    |         |                               |  |
| 07.106                    | <i>LSU loading package name</i>         | <i>(Only visible when IGBT supply unit control activated by 95.20)</i><br>Name of the loading package of the supply unit firmware.   | -          |      |             |   |             |                                  |   |         |                                      |   |           |  |   |         |                              |        |          |  |    |                |   |    |         |                               |  |
| 07.107                    | <i>LSU loading package version</i>      | <i>(Only visible when IGBT supply unit control activated by 95.20)</i><br>Version number of the loading package of the supply unit firmware.   | -          |      |             |   |             |                                  |   |         |                                      |   |           |  |   |         |                              |        |          |  |    |                |   |    |         |                               |  |
| <b>10 Standard DI, RO</b> |   | Configuration of digital inputs and relay outputs.   |            |      |             |   |             |                                  |   |         |                                      |   |           |  |   |         |                              |        |          |  |    |                |   |    |         |                               |  |
| 10.01                     | <i>DI status</i>                        | Displays the electrical status of digital inputs DI1L and DI6...DI1. The activation/deactivation delays of the inputs (if any are specified) are ignored. A filtering time can be defined by parameter <i>10.51 DI filter time</i> .<br>Bits 0...5 reflect the status of DI1...DI6; bit 15 reflects the status of the DI1L input. <b>Example:</b> 1000000000010011b = DI1L, DI5, DI2 and DI1 are on, DI3, DI4 and DI6 are off.<br>This parameter is read-only.   | -          |      |             |   |             |                                  |   |         |                                      |   |           |  |   |         |                              |        |          |  |    |                |   |    |         |                               |  |
|                           | 0000h...FFFFh                           | Status of digital inputs.  | 1 = 1      |      |             |   |             |                                  |   |         |                                      |   |           |  |   |         |                              |        |          |  |    |                |   |    |         |                               |  |

| No.  | Name/Value  | Description   | Def/FbEq16 |     |       |   |   |   |   |   |   |   |   |   |   |   |   |        |          |    |   |
|--|---|---|------------|-----|-------|---|---|---|---|---|---|---|---|---|---|---|---|--------|----------|----|---|
| 10.02  | <i>DI delayed status</i>  | Displays the status of digital inputs DIIL and DI6...DI1. This word is updated only after activation/deactivation delays (if any are specified).<br>Bits 0...5 reflect the delayed status of DI1...DI6; bit 15 reflects the delayed status of the DIIL input.<br>This parameter is read-only. | -          |     |       |   |   |   |   |   |   |   |   |   |   |   |   |        |          |    |   |
|  | 0000h...FFFFh   | Delayed status of digital inputs.   | 1 = 1      |     |       |   |   |   |   |   |   |   |   |   |   |   |   |        |          |    |   |
| 10.03  | <i>DI force selection</i>   | The electrical statuses of the digital inputs can be overridden for eg. testing purposes. A bit in parameter <i>10.04 DI force data</i> is provided for each digital input, and its value is applied whenever the corresponding bit in this parameter is 1.                                   | 0000h      |     |       |   |   |   |   |   |   |   |   |   |   |   |   |        |          |    |   |
| <table border="1"> <thead> <tr> <th>Bit</th> <th>Value</th> </tr> </thead> <tbody> <tr> <td>0</td> <td>1 = Force DI1 to value of bit 0 of parameter <i>10.04 DI force data</i>.</td> </tr> <tr> <td>1</td> <td>1 = Force DI2 to value of bit 1 of parameter <i>10.04 DI force data</i>.</td> </tr> <tr> <td>2</td> <td>1 = Force DI3 to value of bit 2 of parameter <i>10.04 DI force data</i>.</td> </tr> <tr> <td>3</td> <td>1 = Force DI4 to value of bit 3 of parameter <i>10.04 DI force data</i>.</td> </tr> <tr> <td>4</td> <td>1 = Force DI5 to value of bit 4 of parameter <i>10.04 DI force data</i>.</td> </tr> <tr> <td>5</td> <td>1 = Force DI6 to value of bit 5 of parameter <i>10.04 DI force data</i>.</td> </tr> <tr> <td>6...14</td> <td>Reserved</td> </tr> <tr> <td>15</td> <td>1 = Force DIIL to value of bit 15 of parameter <i>10.04 DI force data</i>.</td> </tr> </tbody> </table> |   |   |            | Bit | Value | 0 | 1 = Force DI1 to value of bit 0 of parameter <i>10.04 DI force data</i> . | 1 | 1 = Force DI2 to value of bit 1 of parameter <i>10.04 DI force data</i> . | 2 | 1 = Force DI3 to value of bit 2 of parameter <i>10.04 DI force data</i> . | 3 | 1 = Force DI4 to value of bit 3 of parameter <i>10.04 DI force data</i> . | 4 | 1 = Force DI5 to value of bit 4 of parameter <i>10.04 DI force data</i> . | 5 | 1 = Force DI6 to value of bit 5 of parameter <i>10.04 DI force data</i> . | 6...14 | Reserved | 15 | 1 = Force DIIL to value of bit 15 of parameter <i>10.04 DI force data</i> . |
| Bit  | Value   |   |            |     |       |   |   |   |   |   |   |   |   |   |   |   |   |        |          |    |   |
| 0  | 1 = Force DI1 to value of bit 0 of parameter <i>10.04 DI force data</i> .   |   |            |     |       |   |   |   |   |   |   |   |   |   |   |   |   |        |          |    |   |
| 1  | 1 = Force DI2 to value of bit 1 of parameter <i>10.04 DI force data</i> .   |   |            |     |       |   |   |   |   |   |   |   |   |   |   |   |   |        |          |    |   |
| 2  | 1 = Force DI3 to value of bit 2 of parameter <i>10.04 DI force data</i> .   |   |            |     |       |   |   |   |   |   |   |   |   |   |   |   |   |        |          |    |   |
| 3  | 1 = Force DI4 to value of bit 3 of parameter <i>10.04 DI force data</i> .   |   |            |     |       |   |   |   |   |   |   |   |   |   |   |   |   |        |          |    |   |
| 4  | 1 = Force DI5 to value of bit 4 of parameter <i>10.04 DI force data</i> .   |   |            |     |       |   |   |   |   |   |   |   |   |   |   |   |   |        |          |    |   |
| 5  | 1 = Force DI6 to value of bit 5 of parameter <i>10.04 DI force data</i> .   |   |            |     |       |   |   |   |   |   |   |   |   |   |   |   |   |        |          |    |   |
| 6...14   | Reserved  |   |            |     |       |   |   |   |   |   |   |   |   |   |   |   |   |        |          |    |   |
| 15   | 1 = Force DIIL to value of bit 15 of parameter <i>10.04 DI force data</i> . |   |            |     |       |   |   |   |   |   |   |   |   |   |   |   |   |        |          |    |   |
|  | 0000h...FFFFh   | Override selection for digital inputs.  | 1 = 1      |     |       |   |   |   |   |   |   |   |   |   |   |   |   |        |          |    |   |
| 10.04  | <i>DI force data</i>  | Contains the values that the digital inputs are forced to when selected by <i>10.03 DI force selection</i> .<br>Bit 0 is the forced value for DI1; bit 15 is the forced value for the DIIL input.   | 0000h      |     |       |   |   |   |   |   |   |   |   |   |   |   |   |        |          |    |   |
|  | 0000h...FFFFh   | Forced values of digital inputs.  | 1 = 1      |     |       |   |   |   |   |   |   |   |   |   |   |   |   |        |          |    |   |
| 10.05  | <i>DI1 ON delay</i>   | Defines the activation delay for digital input DI1.   | 0.0 s      |     |       |   |   |   |   |   |   |   |   |   |   |   |   |        |          |    |   |
| <p> <math>t_{On} = 10.05 \text{ DI1 ON delay}</math><br/> <math>t_{Off} = 10.06 \text{ DI1 OFF delay}</math><br/>                     *Electrical status of digital input. Indicated by <i>10.01 DI status</i>.<br/>                     **Indicated by <i>10.02 DI delayed status</i>.                 </p>   |   |   |            |     |       |   |   |   |   |   |   |   |   |   |   |   |   |        |          |    |   |
|  | 0.0 ... 3000.0 s  | Activation delay for DI1.   | 10 = 1 s   |     |       |   |   |   |   |   |   |   |   |   |   |   |   |        |          |    |   |
| 10.06  | <i>DI1 OFF delay</i>  | Defines the deactivation delay for digital input DI1. See parameter <i>10.05 DI1 ON delay</i> .   | 0.0 s      |     |       |   |   |   |   |   |   |   |   |   |   |   |   |        |          |    |   |
|  | 0.0 ... 3000.0 s  | Deactivation delay for DI1.   | 10 = 1 s   |     |       |   |   |   |   |   |   |   |   |   |   |   |   |        |          |    |   |

| No.  | Name/Value                    | Description  | Def/FbEq16 |
|--|-------------------------------|--|------------|
| 10.07  | <a href="#">DI2 ON delay</a>  | Defines the activation delay for digital input DI2.  | 0.0 s      |
| <p> <math>t_{On} = 10.07</math> <a href="#">DI2 ON delay</a><br/> <math>t_{Off} = 10.08</math> <a href="#">DI2 OFF delay</a><br/>           *Electrical status of digital input. Indicated by <a href="#">10.01 DI status</a>.<br/>           **Indicated by <a href="#">10.02 DI delayed status</a>.         </p> |                               |  |            |
|  | 0.0 ... 3000.0 s              | Activation delay for DI2.  | 10 = 1 s   |
| 10.08  | <a href="#">DI2 OFF delay</a> | Defines the deactivation delay for digital input DI2. See parameter <a href="#">10.07 DI2 ON delay</a> . | 0.0 s      |
|  | 0.0 ... 3000.0 s              | Deactivation delay for DI2.  | 10 = 1 s   |
| 10.09  | <a href="#">DI3 ON delay</a>  | Defines the activation delay for digital input DI3.  | 0.0 s      |
| <p> <math>t_{On} = 10.09</math> <a href="#">DI3 ON delay</a><br/> <math>t_{Off} = 10.10</math> <a href="#">DI3 OFF delay</a><br/>           *Electrical status of digital input. Indicated by <a href="#">10.01 DI status</a>.<br/>           **Indicated by <a href="#">10.02 DI delayed status</a>.         </p> |                               |  |            |
|  | 0.0 ... 3000.0 s              | Activation delay for DI3.  | 10 = 1 s   |
| 10.10  | <a href="#">DI3 OFF delay</a> | Defines the deactivation delay for digital input DI3. See parameter <a href="#">10.09 DI3 ON delay</a> . | 0.0 s      |
|  | 0.0 ... 3000.0 s              | Deactivation delay for DI3.  | 10 = 1 s   |

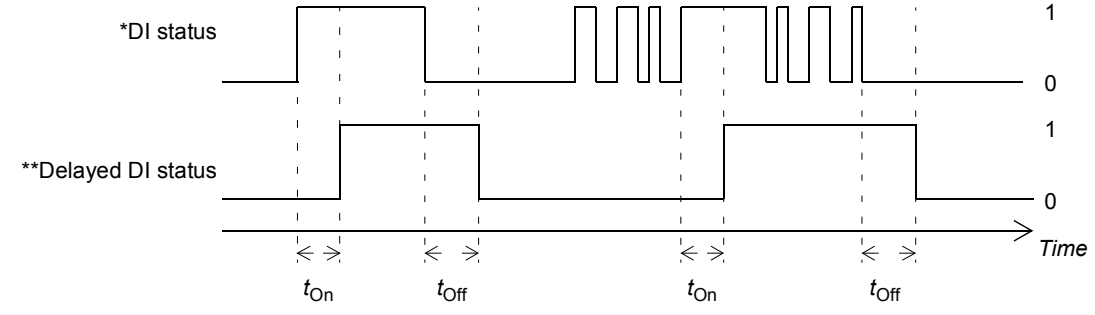
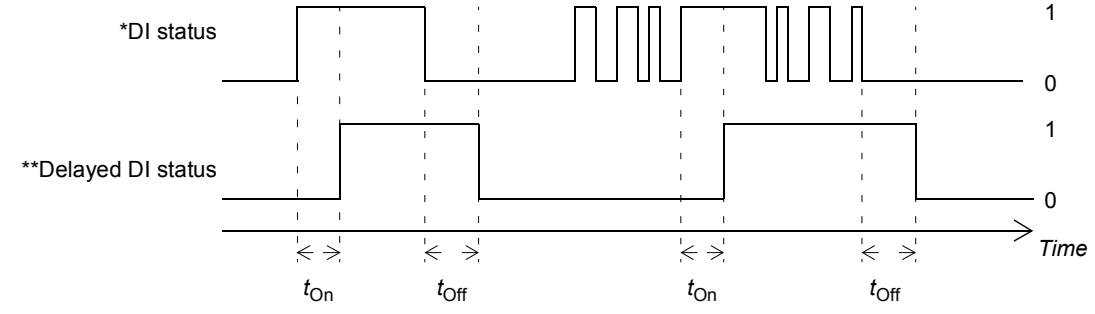
| No.   | Name/Value                    | Description  | Def/FbEq16 |
|---|-------------------------------|--|------------|
| 10.11   | <a href="#">DI4 ON delay</a>  | Defines the activation delay for digital input DI4.  | 0.0 s      |
|  <p data-bbox="221 645 478 678"><math>t_{On} = 10.11</math> <a href="#">DI4 ON delay</a></p> <p data-bbox="221 678 493 712"><math>t_{Off} = 10.12</math> <a href="#">DI4 OFF delay</a></p> <p data-bbox="221 712 838 745">*Electrical status of digital input. Indicated by <a href="#">10.01 DI status</a>.</p> <p data-bbox="221 745 619 779">**Indicated by <a href="#">10.02 DI delayed status</a>.</p>           |                               |  |            |
| 0.0 ... 3000.0 s  |                               | Activation delay for DI4.  | 10 = 1 s   |
| 10.12   | <a href="#">DI4 OFF delay</a> | Defines the deactivation delay for digital input DI4. See parameter <a href="#">10.11 DI4 ON delay</a> . | 0.0 s      |
| 0.0 ... 3000.0 s  |                               | Deactivation delay for DI4.  | 10 = 1 s   |
| 10.13   | <a href="#">DI5 ON delay</a>  | Defines the activation delay for digital input DI5.  | 0.0 s      |
|  <p data-bbox="221 1330 478 1364"><math>t_{On} = 10.13</math> <a href="#">DI5 ON delay</a></p> <p data-bbox="221 1364 493 1397"><math>t_{Off} = 10.14</math> <a href="#">DI5 OFF delay</a></p> <p data-bbox="221 1397 838 1431">*Electrical status of digital input. Indicated by <a href="#">10.01 DI status</a>.</p> <p data-bbox="221 1431 619 1464">**Indicated by <a href="#">10.02 DI delayed status</a>.</p> |                               |  |            |
| 0.0 ... 3000.0 s  |                               | Activation delay for DI5.  | 10 = 1 s   |
| 10.14   | <a href="#">DI5 OFF delay</a> | Defines the deactivation delay for digital input DI5. See parameter <a href="#">10.13 DI5 ON delay</a> . | 0.0 s      |
| 0.0 ... 3000.0 s  |                               | Deactivation delay for DI5.  | 10 = 1 s   |

| No.  | Name/Value         | Description  | Def/FbEq16   |
|--|--------------------|--|--|
| 10.15  | DI6 ON delay       | Defines the activation delay for digital input DI6.  | 0.0 s  |
| <p><math>t_{On} = 10.15</math> DI6 ON delay<br/> <math>t_{Off} = 10.16</math> DI6 OFF delay<br/> *Electrical status of digital input. Indicated by 10.01 DI status.<br/> **Indicated by 10.02 DI delayed status.</p> |                    |  |  |
|  | 0.0 ... 3000.0 s   | Activation delay for DI6.  | 10 = 1 s   |
| 10.16  | DI6 OFF delay      | Defines the deactivation delay for digital input DI6. See parameter 10.15 DI6 ON delay.                      | 0.0 s  |
|  | 0.0 ... 3000.0 s   | Deactivation delay for DI6.  | 10 = 1 s   |
| 10.21  | RO status          | Status of relay outputs RO8...RO1. <b>Example:</b> 00000001b = RO1 is energized, RO2...RO8 are de-energized. | -  |
|  | 0000h...FFFFh      | Status of relay outputs.   | 1 = 1  |
| 10.24  | RO1 source         | Selects a drive signal to be connected to relay output RO1.  | Ready run;<br>10.01 b3 (-1)<br>(95.20 b2);<br>35.105 b1<br>(95.20 b6);<br>06.16 b6<br>(95.20 b9) |
|  | Not energized      | Output is not energized.   | 0  |
|  | Energized          | Output is energized.   | 1  |
|  | Ready run          | Bit 1 of 06.11 Main status word (see page 129).  | 2  |
|  | Enabled            | Bit 0 of 06.16 Drive status word 1 (see page 130).   | 4  |
|  | Started            | Bit 5 of 06.16 Drive status word 1 (see page 130).   | 5  |
|  | Magnetized         | Bit 1 of 06.17 Drive status word 2 (see page 131).   | 6  |
|  | Running            | Bit 6 of 06.16 Drive status word 1 (see page 130).   | 7  |
|  | Ready ref          | Bit 2 of 06.11 Main status word (see page 129).  | 8  |
|  | At setpoint        | Bit 8 of 06.11 Main status word (see page 129).  | 9  |
|  | Reverse            | Bit 2 of 06.19 Speed control status word (see page 133).   | 10   |
|  | Zero speed         | Bit 0 of 06.19 Speed control status word (see page 133).   | 11   |
|  | Above limit        | Bit 10 of 06.17 Drive status word 2 (see page 131).  | 12   |
|  | Warning            | Bit 7 of 06.11 Main status word (see page 129).  | 13   |
|  | Fault              | Bit 3 of 06.11 Main status word (see page 129).  | 14   |
|  | Fault (-1)         | Inverted bit 3 of 06.11 Main status word (see page 129).   | 15   |
|  | Open brake command | Bit 0 of 44.01 Brake control status (see page 317).  | 22   |
|  | Ext2 active        | Bit 11 of 06.16 Drive status word 1 (see page 130).  | 23   |

| No.   | Name/Value                  | Description  | Def/FbEq16                   |
|---|-----------------------------|--|------------------------------|
|   | Remote control              | Bit 9 of <a href="#">06.11 Main status word</a> (see page 129).  | 24                           |
|   | Supervision 1               | Bit 0 of <a href="#">32.01 Supervision status</a> (see page 273).  | 33                           |
|   | Supervision 2               | Bit 1 of <a href="#">32.01 Supervision status</a> (see page 273).  | 34                           |
|   | Supervision 3               | Bit 2 of <a href="#">32.01 Supervision status</a> (see page 273).  | 35                           |
|   | RO/DIO control word bit0    | Bit 0 of <a href="#">10.99 RO/DIO control word</a> (see page 152).   | 40                           |
|   | RO/DIO control word bit1    | Bit 1 of <a href="#">10.99 RO/DIO control word</a> (see page 152).   | 41                           |
|   | RO/DIO control word bit2    | Bit 2 of <a href="#">10.99 RO/DIO control word</a> (see page 152).   | 42                           |
|   | RO/DIO control word bit8    | Bit 8 of <a href="#">10.99 RO/DIO control word</a> (see page 152).   | 43                           |
|   | RO/DIO control word bit9    | Bit 9 of <a href="#">10.99 RO/DIO control word</a> (see page 152).   | 44                           |
|   | <i>Other [bit]</i>          | Source selection (see <a href="#">Terms and abbreviations</a> on page 112).  | -                            |
| <b>10.25</b>  | <b><i>RO1 ON delay</i></b>  | Defines the activation delay for relay output RO1.   | 0.0 s                        |
| <p> <math>t_{On} = 10.25 \text{ RO1 ON delay}</math><br/> <math>t_{Off} = 10.26 \text{ RO1 OFF delay}</math> </p> |                             |  |                              |
|   | 0.0 ... 3000.0 s            | Activation delay for RO1.  | 10 = 1 s                     |
| <b>10.26</b>  | <b><i>RO1 OFF delay</i></b> | Defines the deactivation delay for relay output RO1. See parameter <a href="#">10.25 RO1 ON delay</a> .                                    | 0.0 s                        |
|   | 0.0 ... 3000.0 s            | Deactivation delay for RO1.  | 10 = 1 s                     |
| <b>10.27</b>  | <b><i>RO2 source</i></b>    | Selects a drive signal to be connected to relay output RO2. For the available selections, see parameter <a href="#">10.24 RO1 source</a> . | <i>Running</i><br>(95.20 b3) |

| No.   | Name/Value                     | Description  | Def/FbEq16          |
|---|--------------------------------|--|---------------------|
| 10.28   | <a href="#">RO2 ON delay</a>   | Defines the activation delay for relay output RO2.   | 0.0 s<br>(95.20 b3) |
| <p> <math>t_{On} = 10.28 \text{ RO2 ON delay}</math><br/> <math>t_{Off} = 10.29 \text{ RO2 OFF delay}</math> </p> |                                |  |                     |
|   | 0.0 ... 3000.0 s               | Activation delay for RO2.  | 10 = 1 s            |
| 10.29   | <a href="#">RO2 OFF delay</a>  | Defines the deactivation delay for relay output RO2. See parameter <a href="#">10.28 RO2 ON delay</a> .                                    | 0.0 s<br>(95.20 b3) |
|   | 0.0 ... 3000.0 s               | Deactivation delay for RO2.  | 10 = 1 s            |
| 10.30   | <a href="#">RO3 source</a>     | Selects a drive signal to be connected to relay output RO3. For the available selections, see parameter <a href="#">10.24 RO1 source</a> . | Fault (-1)          |
| 10.31   | <a href="#">RO3 ON delay</a>   | Defines the activation delay for relay output RO3.   | 0.0 s               |
| <p> <math>t_{On} = 10.31 \text{ RO3 ON delay}</math><br/> <math>t_{Off} = 10.32 \text{ RO3 OFF delay}</math> </p> |                                |  |                     |
|   | 0.0 ... 3000.0 s               | Activation delay for RO3.  | 10 = 1 s            |
| 10.32   | <a href="#">RO3 OFF delay</a>  | Defines the deactivation delay for relay output RO3. See parameter <a href="#">10.31 RO3 ON delay</a> .                                    | 0.0 s               |
|   | 0.0 ... 3000.0 s               | Deactivation delay for RO3.  | 10 = 1 s            |
| 10.51   | <a href="#">DI filter time</a> | Defines a filtering time for parameter <a href="#">10.01 DI status</a> .   | 10.0 ms             |
|   | 0.3 ... 100.0 ms               | Filtering time for <a href="#">10.01</a> .   | 10 = 1 ms           |

| No.  | Name/Value                 | Description   | Def/FbEq16       |     |      |             |   |     |  |   |     |   |     |       |          |  |   |      |  |   |      |         |          |  |
|--|----------------------------|---|------------------|-----|------|-------------|---|-----|--|---|-----|---|-----|-------|----------|--|---|------|--|---|------|---------|----------|--|
| 10.99  | <i>RO/DIO control word</i> | Storage parameter for controlling the relay outputs and digital input/outputs eg. through the embedded fieldbus interface.<br>To control the relay outputs (RO) and the digital input/outputs (DIO) of the drive, send a control word with the bit assignments shown below as Modbus I/O data. Set the target selection parameter of that particular data ( <a href="#">58.101</a> ... <a href="#">58.124</a> ) to <i>RO/DIO control word</i> . In the source selection parameter of the desired output, select the appropriate bit of this word. | 0000h            |     |      |             |   |     |  |   |     |   |     |       |          |  |   |      |  |   |      |         |          |  |
| <table border="1"> <thead> <tr> <th>Bit</th> <th>Name</th> <th>Description</th> </tr> </thead> <tbody> <tr> <td>0</td> <td>RO1</td> <td rowspan="3">Source bits for relay outputs RO1...RO3 (see parameters <a href="#">10.24</a>, <a href="#">10.27</a> and <a href="#">10.30</a>).</td> </tr> <tr> <td>1</td> <td>RO2</td> </tr> <tr> <td>2</td> <td>RO3</td> </tr> <tr> <td>3...7</td> <td>Reserved</td> <td></td> </tr> <tr> <td>8</td> <td>DIO1</td> <td rowspan="2">Source bits for digital input/outputs DIO1...DIO3 (see parameters <a href="#">11.06</a> and <a href="#">11.10</a>).</td> </tr> <tr> <td>9</td> <td>DIO2</td> </tr> <tr> <td>10...15</td> <td>Reserved</td> <td></td> </tr> </tbody> </table> |                            |   |                  | Bit | Name | Description | 0 | RO1 | Source bits for relay outputs RO1...RO3 (see parameters <a href="#">10.24</a> , <a href="#">10.27</a> and <a href="#">10.30</a> ). | 1 | RO2 | 2 | RO3 | 3...7 | Reserved |  | 8 | DIO1 | Source bits for digital input/outputs DIO1...DIO3 (see parameters <a href="#">11.06</a> and <a href="#">11.10</a> ). | 9 | DIO2 | 10...15 | Reserved |  |
| Bit  | Name                       | Description   |                  |     |      |             |   |     |  |   |     |   |     |       |          |  |   |      |  |   |      |         |          |  |
| 0  | RO1                        | Source bits for relay outputs RO1...RO3 (see parameters <a href="#">10.24</a> , <a href="#">10.27</a> and <a href="#">10.30</a> ).  |                  |     |      |             |   |     |  |   |     |   |     |       |          |  |   |      |  |   |      |         |          |  |
| 1  | RO2                        |   |                  |     |      |             |   |     |  |   |     |   |     |       |          |  |   |      |  |   |      |         |          |  |
| 2  | RO3                        |   |                  |     |      |             |   |     |  |   |     |   |     |       |          |  |   |      |  |   |      |         |          |  |
| 3...7  | Reserved                   |   |                  |     |      |             |   |     |  |   |     |   |     |       |          |  |   |      |  |   |      |         |          |  |
| 8  | DIO1                       | Source bits for digital input/outputs DIO1...DIO3 (see parameters <a href="#">11.06</a> and <a href="#">11.10</a> ).  |                  |     |      |             |   |     |  |   |     |   |     |       |          |  |   |      |  |   |      |         |          |  |
| 9  | DIO2                       |   |                  |     |      |             |   |     |  |   |     |   |     |       |          |  |   |      |  |   |      |         |          |  |
| 10...15  | Reserved                   |   |                  |     |      |             |   |     |  |   |     |   |     |       |          |  |   |      |  |   |      |         |          |  |
| 0000h...FFFFh  |                            | RO/DIO control word.  | 1 = 1            |     |      |             |   |     |  |   |     |   |     |       |          |  |   |      |  |   |      |         |          |  |
| <b>11 Standard DIO, FI, FO</b>   |                            | Configuration of digital input/outputs and frequency inputs/outputs.  |                  |     |      |             |   |     |  |   |     |   |     |       |          |  |   |      |  |   |      |         |          |  |
| 11.01  | <i>DIO status</i>          | Displays the status of digital input/outputs DIO2 and DIO1. The activation/deactivation delays (if any are specified) are ignored. A filtering time (for input mode) can be defined by parameter <a href="#">10.51 DI filter time</a> .<br><b>Example:</b> 0010 = DIO2 is on, DIO1 is off.<br>This parameter is read-only.  | -                |     |      |             |   |     |  |   |     |   |     |       |          |  |   |      |  |   |      |         |          |  |
| 0000b...0011b  |                            | Status of digital input/outputs.  | 1 = 1            |     |      |             |   |     |  |   |     |   |     |       |          |  |   |      |  |   |      |         |          |  |
| 11.02  | <i>DIO delayed status</i>  | Displays the delayed status of digital input/outputs DIO2 and DIO1. This word is updated only after activation/deactivation delays (if any are specified).<br><b>Example:</b> 0010 = DIO2 is on, DIO1 is off.<br>This parameter is read-only.   | -                |     |      |             |   |     |  |   |     |   |     |       |          |  |   |      |  |   |      |         |          |  |
| 0000b...0011b  |                            | Delayed status of digital input/outputs.  | 1 = 1            |     |      |             |   |     |  |   |     |   |     |       |          |  |   |      |  |   |      |         |          |  |
| 11.05  | <i>DIO1 function</i>       | Selects whether DIO1 is used as a digital output or input, or a frequency input.  | <i>Output</i>    |     |      |             |   |     |  |   |     |   |     |       |          |  |   |      |  |   |      |         |          |  |
| Output   |                            | DIO1 is used as a digital output.   | 0                |     |      |             |   |     |  |   |     |   |     |       |          |  |   |      |  |   |      |         |          |  |
| Input  |                            | DIO1 is used as a digital input.  | 1                |     |      |             |   |     |  |   |     |   |     |       |          |  |   |      |  |   |      |         |          |  |
| Frequency  |                            | DIO1 is used as a frequency input.  | 2                |     |      |             |   |     |  |   |     |   |     |       |          |  |   |      |  |   |      |         |          |  |
| 11.06  | <i>DIO1 output source</i>  | Selects a drive signal to be connected to digital input/output DIO1 when parameter <a href="#">11.05 DIO1 function</a> is set to <i>Output</i> .  | <i>Ready run</i> |     |      |             |   |     |  |   |     |   |     |       |          |  |   |      |  |   |      |         |          |  |
| Not energized  |                            | Output is off.  | 0                |     |      |             |   |     |  |   |     |   |     |       |          |  |   |      |  |   |      |         |          |  |
| Energized  |                            | Output is on.   | 1                |     |      |             |   |     |  |   |     |   |     |       |          |  |   |      |  |   |      |         |          |  |
| Ready run  |                            | Bit 1 of <a href="#">06.11 Main status word</a> (see page <a href="#">129</a> ).  | 2                |     |      |             |   |     |  |   |     |   |     |       |          |  |   |      |  |   |      |         |          |  |
| Enabled  |                            | Bit 0 of <a href="#">06.16 Drive status word 1</a> (see page <a href="#">130</a> ).   | 4                |     |      |             |   |     |  |   |     |   |     |       |          |  |   |      |  |   |      |         |          |  |
| Started  |                            | Bit 5 of <a href="#">06.16 Drive status word 1</a> (see page <a href="#">130</a> ).   | 5                |     |      |             |   |     |  |   |     |   |     |       |          |  |   |      |  |   |      |         |          |  |
| Magnetized   |                            | Bit 1 of <a href="#">06.17 Drive status word 2</a> (see page <a href="#">131</a> ).   | 6                |     |      |             |   |     |  |   |     |   |     |       |          |  |   |      |  |   |      |         |          |  |
| Running  |                            | Bit 6 of <a href="#">06.16 Drive status word 1</a> (see page <a href="#">130</a> ).   | 7                |     |      |             |   |     |  |   |     |   |     |       |          |  |   |      |  |   |      |         |          |  |





| No.  | Name/Value                   | Description  | Def/FbEq16 |
|--|------------------------------|--|------------|
|  | Ready ref                    | Bit 2 of <a href="#">06.11 Main status word</a> (see page 129).  | 8          |
|  | At setpoint                  | Bit 8 of <a href="#">06.11 Main status word</a> (see page 129).  | 9          |
|  | Reverse                      | Bit 2 of <a href="#">06.19 Speed control status word</a> (see page 133).   | 10         |
|  | Zero speed                   | Bit 0 of <a href="#">06.19 Speed control status word</a> (see page 133).   | 11         |
|  | Above limit                  | Bit 10 of <a href="#">06.17 Drive status word 2</a> (see page 131).  | 12         |
|  | Warning                      | Bit 7 of <a href="#">06.11 Main status word</a> (see page 129).  | 13         |
|  | Fault                        | Bit 3 of <a href="#">06.11 Main status word</a> (see page 129).  | 14         |
|  | Fault (-1)                   | Inverted bit 3 of <a href="#">06.11 Main status word</a> (see page 129).   | 15         |
|  | Open brake command           | Bit 0 of <a href="#">44.01 Brake control status</a> (see page 317).  | 22         |
|  | Ext2 active                  | Bit 11 of <a href="#">06.16 Drive status word 1</a> (see page 130).  | 23         |
|  | Remote control               | Bit 9 of <a href="#">06.11 Main status word</a> (see page 129).  | 24         |
|  | Supervision 1                | Bit 0 of <a href="#">32.01 Supervision status</a> (see page 273).  | 33         |
|  | Supervision 2                | Bit 1 of <a href="#">32.01 Supervision status</a> (see page 273).  | 34         |
|  | Supervision 3                | Bit 2 of <a href="#">32.01 Supervision status</a> (see page 273).  | 35         |
|  | RO/DIO control word bit0     | Bit 0 of <a href="#">10.99 RO/DIO control word</a> (see page 152).   | 40         |
|  | RO/DIO control word bit1     | Bit 1 of <a href="#">10.99 RO/DIO control word</a> (see page 152).   | 41         |
|  | RO/DIO control word bit2     | Bit 2 of <a href="#">10.99 RO/DIO control word</a> (see page 152).   | 42         |
|  | RO/DIO control word bit8     | Bit 8 of <a href="#">10.99 RO/DIO control word</a> (see page 152).   | 43         |
|  | RO/DIO control word bit9     | Bit 9 of <a href="#">10.99 RO/DIO control word</a> (see page 152).   | 44         |
|  | <i>Other [bit]</i>           | Source selection (see <a href="#">Terms and abbreviations</a> on page 112).  | -          |
| <b>11.07</b>   | <b><i>DIO1 ON delay</i></b>  | Defines the activation delay for digital input/output DIO1 (when used as a digital output or digital input).   | 0.0 s      |
| <p><i>t<sub>On</sub></i> = <a href="#">11.07 DIO1 ON delay</a><br/> <i>t<sub>Off</sub></i> = <a href="#">11.08 DIO1 OFF delay</a><br/> *Electrical status of DIO (in input mode) or status of selected source (in output mode). Indicated by <a href="#">11.01 DIO status</a>.<br/> **Indicated by <a href="#">11.02 DIO delayed status</a>.</p> |                              |  |            |
|  | 0.0 ... 3000.0 s             | Activation delay for DIO1.   | 10 = 1 s   |
| <b>11.08</b>   | <b><i>DIO1 OFF delay</i></b> | Defines the deactivation delay for digital input/output DIO1 (when used as a digital output or digital input). See parameter <a href="#">11.07 DIO1 ON delay</a> . | 0.0 s      |
|  | 0.0 ... 3000.0 s             | Deactivation delay for DIO1.   | 10 = 1 s   |

| No.   | Name/Value                    | Description  | Def/FbEq16     |
|-------|-------------------------------|--|----------------|
| 11.09 | <i>DIO2 function</i>          | Selects whether DIO2 is used as a digital output or input, or a frequency output.  | <i>Output</i>  |
|       | Output                        | DIO2 is used as a digital output.  | 0              |
|       | Input                         | DIO2 is used as a digital input.   | 1              |
|       | Frequency                     | DIO2 is used as a frequency output.  | 2              |
| 11.10 | <i>DIO2 output source</i>     | Selects a drive signal to be connected to digital input/output DIO2 when parameter 11.09 <i>DIO2 function</i> is set to <i>Output</i> . For the available selections, see parameter 11.06 <i>DIO1 output source</i> .  | <i>Running</i> |
| 11.11 | <i>DIO2 ON delay</i>          | Defines the activation delay for digital input/output DIO2 (when used as a digital output or digital input).   | 0.0 s          |
|       |                               | <p> <math>t_{On} = 11.11</math> <i>DIO2 ON delay</i><br/> <math>t_{Off} = 11.12</math> <i>DIO2 OFF delay</i><br/>                     *Electrical status of DIO (in input mode) or status of selected source (in output mode). Indicated by 11.01 <i>DIO status</i>.<br/>                     **Indicated by 11.02 <i>DIO delayed status</i>.                 </p> |                |
|       | 0.0 ... 3000.0 s              | Activation delay for DIO2.   | 10 = 1 s       |
| 11.12 | <i>DIO2 OFF delay</i>         | Defines the deactivation delay for digital input/output DIO2 (when used as a digital output or digital input). See parameter 11.11 <i>DIO2 ON delay</i> .  | 0.0 s          |
|       | 0.0 ... 3000.0 s              | Deactivation delay for DIO2.   | 10 = 1 s       |
| 11.38 | <i>Freq in 1 actual value</i> | Displays the value of frequency input 1 (via DIO1 when it is used as a frequency input) before scaling. See parameter 11.42 <i>Freq in 1 min</i> . This parameter is read-only.  | -              |
|       | 0 ... 16000 Hz                | Unscaled value of frequency input 1.   | 1 = 1 Hz       |
| 11.39 | <i>Freq in 1 scaled</i>       | Displays the value of frequency input 1 (via DIO1 when it is used as a frequency input) after scaling. See parameter 11.42 <i>Freq in 1 min</i> . This parameter is read-only.   | -              |
|       | -32768.000 ... 32767.000      | Scaled value of frequency input 1.   | 1 = 1          |

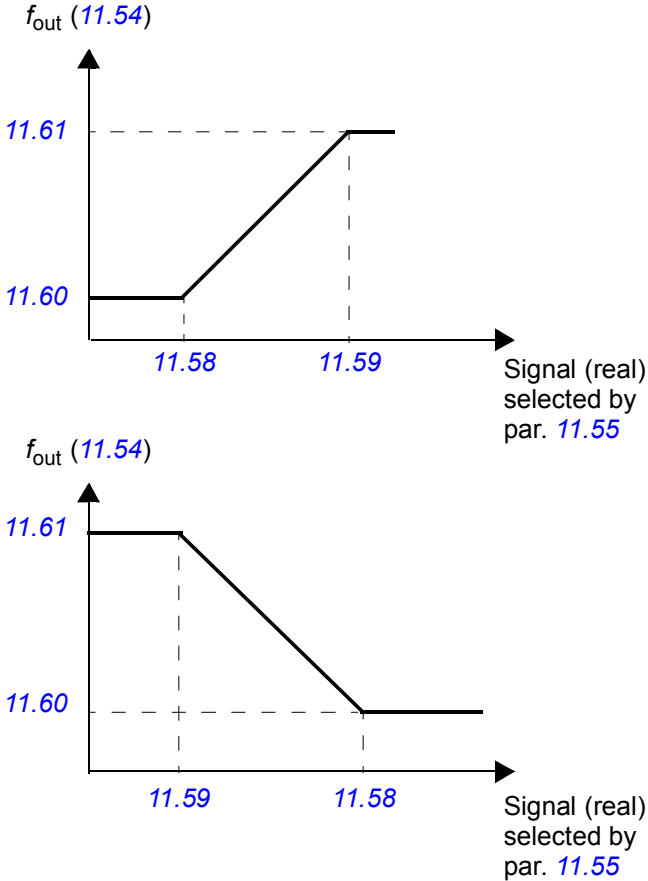
| No.   | Name/Value                     | Description   | Def/FbEq16                          |
|-------|--------------------------------|---|-------------------------------------|
| 11.42 | <i>Freq in 1 min</i>           | <p>Defines the minimum for the frequency actually arriving at frequency input 1 (DIO1 when it is used as a frequency input). The incoming frequency signal (<i>11.38 Freq in 1 actual value</i>) is scaled into an internal signal (<i>11.39 Freq in 1 scaled</i>) by parameters <i>11.42...11.45</i> as follows:</p> | 0 Hz                                |
|       | 0 ... 16000 Hz                 | Minimum frequency of frequency input 1 (DIO1).  | 1 = 1 Hz                            |
| 11.43 | <i>Freq in 1 max</i>           | Defines the maximum for the frequency actually arriving at frequency input 1 (DIO1 when it is used as a frequency input). See parameter <i>11.42 Freq in 1 min</i> .  | 16000 Hz                            |
|       | 0 ... 16000 Hz                 | Maximum frequency for frequency input 1 (DIO1).   | 1 = 1 Hz                            |
| 11.44 | <i>Freq in 1 at scaled min</i> | Defines the value that is required to correspond internally to the minimum input frequency defined by parameter <i>11.42 Freq in 1 min</i> . See diagram at parameter <i>11.42 Freq in 1 min</i> .  | 0.000                               |
|       | -32768.000 ... 32767.000       | Value corresponding to minimum of frequency input 1.  | 1 = 1                               |
| 11.45 | <i>Freq in 1 at scaled max</i> | Defines the value that is required to correspond internally to the maximum input frequency defined by parameter <i>11.43 Freq in 1 max</i> . See diagram at parameter <i>11.42 Freq in 1 min</i> .  | 1500.000;<br>1800.000<br>(95.20 b0) |
|       | -32768.000 ... 32767.000       | Value corresponding to maximum of frequency input 1.  | 1 = 1                               |
| 11.54 | <i>Freq out 1 actual value</i> | Displays the value of frequency output 1 after scaling. See parameter <i>11.58 Freq out 1 src min</i> . This parameter is read-only.  | -                                   |
|       | 0 ... 16000 Hz                 | Value of frequency output 1.  | 1 = 1                               |
| 11.55 | <i>Freq out 1 source</i>       | Selects a signal to be connected to frequency output 1.   | <i>Motor speed used</i>             |
|       | Zero                           | None.   | 0                                   |
|       | Motor speed used               | <i>01.01 Motor speed used</i> (page 115).   | 1                                   |
|       | Output frequency               | <i>01.06 Output frequency</i> (page 115).   | 3                                   |
|       | Motor current                  | <i>01.07 Motor current</i> (page 115).  | 4                                   |
|       | Motor torque                   | <i>01.10 Motor torque</i> (page 115).   | 6                                   |
|       | DC voltage                     | <i>01.11 DC voltage</i> (page 115).   | 7                                   |
|       | Power inu out                  | <i>01.14 Output power</i> (page 116).   | 8                                   |

| No.                   | Name/Value                         | Description   | Def/FbEq16   |
|-----------------------|------------------------------------|---|--|
|                       | Speed ref ramp in                  | <a href="#">23.01 Speed ref ramp input</a> (page 218).  | 10   |
|                       | Speed ref ramped                   | <a href="#">23.02 Speed ref ramp output</a> (page 218).   | 11   |
|                       | Speed ref used                     | <a href="#">24.01 Used speed reference</a> (page 224).  | 12   |
|                       | Torq ref used                      | <a href="#">26.02 Torque reference used</a> (page 240).   | 13   |
|                       | Freq ref used                      | <a href="#">28.02 Frequency ref ramp output</a> (page 246).   | 14   |
|                       | Process PID out                    | <a href="#">40.01 Process PID output actual</a> (page 301).   | 16   |
|                       | Process PID fbk                    | <a href="#">40.02 Process PID feedback actual</a> (page 301).   | 17   |
|                       | Process PID act                    | <a href="#">40.03 Process PID setpoint actual</a> (page 301).   | 18   |
|                       | Process PID dev                    | <a href="#">40.04 Process PID deviation actual</a> (page 301).  | 19   |
|                       | <i>Other</i>                       | Source selection (see <a href="#">Terms and abbreviations</a> on page 112).   | -  |
| <a href="#">11.58</a> | <a href="#">Freq out 1 src min</a> | <p>Defines the real value of the signal (selected by parameter <a href="#">11.55 Freq out 1 source</a> and shown by parameter <a href="#">11.54 Freq out 1 actual value</a>) that corresponds to the minimum value of frequency output 1 (defined by parameter <a href="#">11.60 Freq out 1 at src min</a>).</p>  <p>The figure contains two graphs. Both graphs have a vertical axis labeled <math>f_{out} (11.54)</math> and a horizontal axis labeled 'Signal (real) selected by par. 11.55'.<br/>         The top graph shows a signal increasing from 11.58 to 11.59. The frequency output <math>f_{out}</math> is constant at 11.60 for signals up to 11.58, then increases linearly to 11.61 at signal 11.59, and remains constant at 11.61 for higher signals.<br/>         The bottom graph shows a signal decreasing from 11.59 to 11.58. The frequency output <math>f_{out}</math> is constant at 11.61 for signals up to 11.59, then decreases linearly to 11.60 at signal 11.58, and remains constant at 11.60 for lower signals.</p> | 0.000  |
|                       | -32768.000 ...<br>32767.000        | Real signal value corresponding to minimum value of frequency output 1.   | 1 = 1  |
| <a href="#">11.59</a> | <a href="#">Freq out 1 src max</a> | <p>Defines the real value of the signal (selected by parameter <a href="#">11.55 Freq out 1 source</a> and shown by parameter <a href="#">11.54 Freq out 1 actual value</a>) that corresponds to the maximum value of frequency output 1 (defined by parameter <a href="#">11.61 Freq out 1 at src max</a>). See parameter <a href="#">11.58 Freq out 1 src min</a>.</p>  | 1500.000;<br>1800.000<br>( <a href="#">95.20</a> b0) |
|                       | -32768.000 ...<br>32767.000        | Real signal value corresponding to maximum value of frequency output 1.   | 1 = 1  |

| No.                   | Name/Value                     | Description  | Def/FbEq16       |
|-----------------------|--------------------------------|--|------------------|
| 11.60                 | <i>Freq out 1 at src min</i>   | Defines the minimum value of frequency output 1. See diagrams at parameter <i>11.58 Freq out 1 src min</i> .   | 0 Hz             |
|                       | 0...16000 Hz                   | Minimum value of frequency output 1.   | 1 = 1 Hz         |
| 11.61                 | <i>Freq out 1 at src max</i>   | Defines the maximum value of frequency output 1. See diagrams at parameter <i>11.58 Freq out 1 src min</i> .   | 16000 Hz         |
|                       | 0...16000 Hz                   | Maximum value of frequency output 1.   | 1 = 1 Hz         |
| 11.81                 | <i>DIO filter time</i>         | Defines a filtering time for parameter <i>11.01 DIO status</i> . The filtering time will only affect the DIOs that are in input mode.  | 10.0 ms          |
|                       | 0.3 ... 100.0 ms               | Filtering time for <i>11.01</i> .  | 10 = 1 ms        |
| <b>12 Standard AI</b> |                                | Configuration of standard analog inputs.   |                  |
| 12.01                 | <i>AI tune</i>                 | Triggers the analog input tuning function.<br>Connect the signal to the input and select the appropriate tuning function.  |                  |
|                       | No action                      | AI tune is not activated.  | 0                |
|                       | AI1 min tune                   | Current analog input AI1 signal value is set as minimum value of AI1 into parameter <i>12.17 AI1 min</i> . The value reverts back to <i>No action</i> automatically.   | 1                |
|                       | AI1 max tune                   | Current analog input AI1 signal value is set as maximum value of AI1 into parameter <i>12.18 AI1 max</i> . The value reverts back to <i>No action</i> automatically.   | 2                |
|                       | AI2 min tune                   | Current analog input AI2 signal value is set as minimum value of AI2 into parameter <i>12.27 AI2 min</i> . The value reverts back to <i>No action</i> automatically.   | 3                |
|                       | AI2 max tune                   | Current analog input AI2 signal value is set as maximum value of AI2 into parameter <i>12.28 AI2 max</i> . The value reverts back to <i>No action</i> automatically.   | 4                |
| 12.03                 | <i>AI supervision function</i> | Selects how the drive reacts when an analog input signal moves out of the minimum and/or maximum limits specified for the input.<br>The supervision applies a margin of 0.5 V or 1.0 mA to the limits. For example, if the maximum limit for the input is 7.000 V, the maximum limit supervision activates at 7.500 V. The inputs and the limits to be observed are selected by parameter <i>12.04 AI supervision selection</i> .<br><b>Note:</b> Analog input signal supervision is only active when <ul style="list-style-type: none"> <li>the analog input is set as the source (using the <i>AI1 scaled</i> or <i>AI2 scaled</i> selection) in parameter <i>22.11</i>, <i>22.12</i>, <i>22.15</i>, <i>22.17</i>, <i>23.42</i>, <i>26.11</i>, <i>26.12</i>, <i>26.16</i>, <i>26.25</i>, <i>28.11</i>, <i>28.12</i>, <i>30.21</i>, <i>30.22</i>, <i>40.16</i>, <i>40.17</i>, <i>40.50</i>, <i>41.16</i>, <i>41.17</i>, <i>41.50</i> or <i>44.09</i>, and is being used as the active source, or</li> <li>supervision is forced using parameter <i>12.05 AI supervision force</i>.</li> </ul> | <i>No action</i> |
|                       | No action                      | No action taken.   | 0                |
|                       | Fault                          | Drive trips on <i>80A0 AI supervision</i> .  | 1                |
|                       | Warning                        | Drive generates an <i>A8A0 AI supervision</i> warning.   | 2                |
|                       | Last speed                     | Drive generates a warning ( <i>A8A0 AI supervision</i> ) and freezes the speed (or frequency) to the level the drive was operating at. The speed/frequency is determined on the basis of actual speed using 850 ms low-pass filtering.<br> <b>WARNING!</b> Make sure that it is safe to continue operation in case of a communication break.  | 3                |

| No.          | Name/Value                      | Description   | Def/FbEq16          |      |             |   |           |   |   |           |   |   |           |  |   |           |  |        |          |   |   |          |   |   |           |  |        |          |  |  |
|--------------|---------------------------------|---|---------------------|------|-------------|---|-----------|---|---|-----------|---|---|-----------|--|---|-----------|--|--------|----------|---|---|----------|---|---|-----------|--|--------|----------|--|--|
|              | Speed ref safe                  | Drive generates a warning ( <i>A8A0 AI supervision</i> ) and sets the speed to the speed defined by parameter <i>22.41 Speed ref safe</i> (or <i>28.41 Frequency ref safe</i> when frequency reference is being used).<br> <b>WARNING!</b> Make sure that it is safe to continue operation in case of a communication break.   | 4                   |      |             |   |           |   |   |           |   |   |           |  |   |           |  |        |          |   |   |          |   |   |           |  |        |          |  |  |
| <b>12.04</b> | <i>AI supervision selection</i> | Specifies the analog input limits to be supervised. See parameter <i>12.03 AI supervision function</i> .  | 0000b               |      |             |   |           |   |   |           |   |   |           |  |   |           |  |        |          |   |   |          |   |   |           |  |        |          |  |  |
|              |                                 | <table border="1"> <thead> <tr> <th>Bit</th> <th>Name</th> <th>Description</th> </tr> </thead> <tbody> <tr> <td>0</td> <td>AI1 &lt; MIN</td> <td>1 = Minimum limit supervision of AI1 active.</td> </tr> <tr> <td>1</td> <td>AI1 &gt; MAX</td> <td>1 = Maximum limit supervision of AI1 active.</td> </tr> <tr> <td>2</td> <td>AI2 &lt; MIN</td> <td>1 = Minimum limit supervision of AI2 active.</td> </tr> <tr> <td>3</td> <td>AI2 &gt; MAX</td> <td>1 = Maximum limit supervision of AI2 active.</td> </tr> <tr> <td>4...15</td> <td>Reserved</td> <td></td> </tr> </tbody> </table>   | Bit                 | Name | Description | 0 | AI1 < MIN | 1 = Minimum limit supervision of AI1 active.        | 1 | AI1 > MAX | 1 = Maximum limit supervision of AI1 active.        | 2 | AI2 < MIN | 1 = Minimum limit supervision of AI2 active.                 | 3 | AI2 > MAX | 1 = Maximum limit supervision of AI2 active. | 4...15 | Reserved |   |   |          |   |   |           |  |        |          |  |  |
| Bit          | Name                            | Description   |                     |      |             |   |           |   |   |           |   |   |           |  |   |           |  |        |          |   |   |          |   |   |           |  |        |          |  |  |
| 0            | AI1 < MIN                       | 1 = Minimum limit supervision of AI1 active.  |                     |      |             |   |           |   |   |           |   |   |           |  |   |           |  |        |          |   |   |          |   |   |           |  |        |          |  |  |
| 1            | AI1 > MAX                       | 1 = Maximum limit supervision of AI1 active.  |                     |      |             |   |           |   |   |           |   |   |           |  |   |           |  |        |          |   |   |          |   |   |           |  |        |          |  |  |
| 2            | AI2 < MIN                       | 1 = Minimum limit supervision of AI2 active.  |                     |      |             |   |           |   |   |           |   |   |           |  |   |           |  |        |          |   |   |          |   |   |           |  |        |          |  |  |
| 3            | AI2 > MAX                       | 1 = Maximum limit supervision of AI2 active.  |                     |      |             |   |           |   |   |           |   |   |           |  |   |           |  |        |          |   |   |          |   |   |           |  |        |          |  |  |
| 4...15       | Reserved                        |   |                     |      |             |   |           |   |   |           |   |   |           |  |   |           |  |        |          |   |   |          |   |   |           |  |        |          |  |  |
|              | 0000b...1111b                   | Activation of analog input supervision.   | 1 = 1               |      |             |   |           |   |   |           |   |   |           |  |   |           |  |        |          |   |   |          |   |   |           |  |        |          |  |  |
| <b>12.05</b> | <i>AI supervision force</i>     | Activates analog input supervision separately for each control location (see section <i>Local control vs. external control</i> on page 20).<br>The parameter is primarily intended for analog input supervision when the input is connected to the application program and not selected as a control source by drive parameters.  | 0000 0000b          |      |             |   |           |   |   |           |   |   |           |  |   |           |  |        |          |   |   |          |   |   |           |  |        |          |  |  |
|              |                                 | <table border="1"> <thead> <tr> <th>Bit</th> <th>Name</th> <th>Description</th> </tr> </thead> <tbody> <tr> <td>0</td> <td>AI1 Ext1</td> <td>1 = AI1 supervision active when EXT1 is being used.</td> </tr> <tr> <td>1</td> <td>AI1 Ext2</td> <td>1 = AI1 supervision active when EXT2 is being used.</td> </tr> <tr> <td>2</td> <td>AI1 Local</td> <td>1 = AI1 supervision active when local control is being used.</td> </tr> <tr> <td>3</td> <td>Reserved</td> <td></td> </tr> <tr> <td>4</td> <td>AI2 Ext1</td> <td>1 = AI2 supervision active when EXT1 is being used.</td> </tr> <tr> <td>5</td> <td>AI2 Ext2</td> <td>1 = AI2 supervision active when EXT2 is being used.</td> </tr> <tr> <td>6</td> <td>AI2 Local</td> <td>1 = AI2 supervision active when local control is being used.</td> </tr> <tr> <td>7...15</td> <td>Reserved</td> <td></td> </tr> </tbody> </table> | Bit                 | Name | Description | 0 | AI1 Ext1  | 1 = AI1 supervision active when EXT1 is being used. | 1 | AI1 Ext2  | 1 = AI1 supervision active when EXT2 is being used. | 2 | AI1 Local | 1 = AI1 supervision active when local control is being used. | 3 | Reserved  |  | 4      | AI2 Ext1 | 1 = AI2 supervision active when EXT1 is being used. | 5 | AI2 Ext2 | 1 = AI2 supervision active when EXT2 is being used. | 6 | AI2 Local | 1 = AI2 supervision active when local control is being used. | 7...15 | Reserved |  |  |
| Bit          | Name                            | Description   |                     |      |             |   |           |   |   |           |   |   |           |  |   |           |  |        |          |   |   |          |   |   |           |  |        |          |  |  |
| 0            | AI1 Ext1                        | 1 = AI1 supervision active when EXT1 is being used.   |                     |      |             |   |           |   |   |           |   |   |           |  |   |           |  |        |          |   |   |          |   |   |           |  |        |          |  |  |
| 1            | AI1 Ext2                        | 1 = AI1 supervision active when EXT2 is being used.   |                     |      |             |   |           |   |   |           |   |   |           |  |   |           |  |        |          |   |   |          |   |   |           |  |        |          |  |  |
| 2            | AI1 Local                       | 1 = AI1 supervision active when local control is being used.  |                     |      |             |   |           |   |   |           |   |   |           |  |   |           |  |        |          |   |   |          |   |   |           |  |        |          |  |  |
| 3            | Reserved                        |   |                     |      |             |   |           |   |   |           |   |   |           |  |   |           |  |        |          |   |   |          |   |   |           |  |        |          |  |  |
| 4            | AI2 Ext1                        | 1 = AI2 supervision active when EXT1 is being used.   |                     |      |             |   |           |   |   |           |   |   |           |  |   |           |  |        |          |   |   |          |   |   |           |  |        |          |  |  |
| 5            | AI2 Ext2                        | 1 = AI2 supervision active when EXT2 is being used.   |                     |      |             |   |           |   |   |           |   |   |           |  |   |           |  |        |          |   |   |          |   |   |           |  |        |          |  |  |
| 6            | AI2 Local                       | 1 = AI2 supervision active when local control is being used.  |                     |      |             |   |           |   |   |           |   |   |           |  |   |           |  |        |          |   |   |          |   |   |           |  |        |          |  |  |
| 7...15       | Reserved                        |   |                     |      |             |   |           |   |   |           |   |   |           |  |   |           |  |        |          |   |   |          |   |   |           |  |        |          |  |  |
|              | 0000 0000b ...<br>0111 0111b    | Analog input supervision selection.   | 1 = 1               |      |             |   |           |   |   |           |   |   |           |  |   |           |  |        |          |   |   |          |   |   |           |  |        |          |  |  |
| <b>12.11</b> | <i>AI1 actual value</i>         | Displays the value of analog input AI1 in mA or V (depending on whether the input is set to current or voltage by a hardware setting).<br>This parameter is read-only.  | -                   |      |             |   |           |   |   |           |   |   |           |  |   |           |  |        |          |   |   |          |   |   |           |  |        |          |  |  |
|              | -22.000 ... 22.000<br>mA or V   | Value of analog input AI1.  | 1000 = 1 mA<br>or V |      |             |   |           |   |   |           |   |   |           |  |   |           |  |        |          |   |   |          |   |   |           |  |        |          |  |  |
| <b>12.12</b> | <i>AI1 scaled value</i>         | Displays the value of analog input AI1 after scaling. See parameters <i>12.19 AI1 scaled at AI1 min</i> and <i>12.20 AI1 scaled at AI1 max</i> .<br>This parameter is read-only.  | -                   |      |             |   |           |   |   |           |   |   |           |  |   |           |  |        |          |   |   |          |   |   |           |  |        |          |  |  |
|              | -32768.000 ...<br>32767.000     | Scaled value of analog input AI1.   | 1 = 1               |      |             |   |           |   |   |           |   |   |           |  |   |           |  |        |          |   |   |          |   |   |           |  |        |          |  |  |

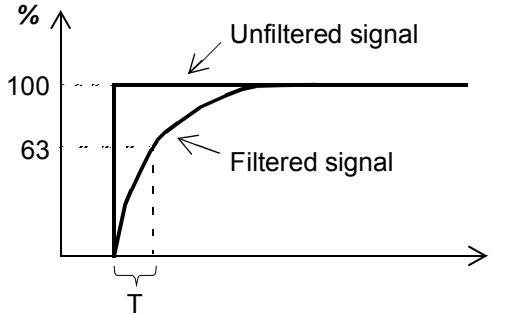
| No.   | Name/Value                         | Description  | Def/FbEq16            |
|-------|------------------------------------|--|-----------------------|
| 12.15 | <a href="#">AI1 unit selection</a> | Selects the unit for readings and settings related to analog input AI1.<br><b>Note:</b> This setting must match the corresponding hardware setting on the drive control unit (see the hardware manual of the drive). Control board reboot (either by cycling the power or through parameter <a href="#">96.08 Control board boot</a> ) is required to validate any changes in the hardware settings.   | V                     |
|       | V                                  | Volts.   | 2                     |
|       | mA                                 | Milliamperes.  | 10                    |
| 12.16 | <a href="#">AI1 filter time</a>    | Defines the filter time constant for analog input AI1.<br> $O = I \times (1 - e^{-t/T})$ <p>             I = filter input (step)<br/>             O = filter output<br/>             t = time<br/>             T = filter time constant           </p> <b>Note:</b> The signal is also filtered due to the signal interface hardware (approximately 0.25 ms time constant). This cannot be changed by any parameter. | 0.100 s               |
|       | 0.000 ... 30.000 s                 | Filter time constant.  | 1000 = 1 s            |
| 12.17 | <a href="#">AI1 min</a>            | Defines the minimum site value for analog input AI1.<br>Set the value actually sent to the drive when the analog signal from plant is wound to its minimum setting.<br>See also parameter <a href="#">12.01 AI tune</a> .  | 0.000 mA or V         |
|       | -22.000 ... 22.000 mA or V         | Minimum value of AI1.  | 1000 = 1 mA or V      |
| 12.18 | <a href="#">AI1 max</a>            | Defines the maximum site value for analog input AI1.<br>Set the value actually sent to the drive when the analog signal from plant is wound to its maximum setting.<br>See also parameter <a href="#">12.01 AI tune</a> .  | 20.000 mA or 10.000 V |
|       | -22.000 ... 22.000 mA or V         | Maximum value of AI1.  | 1000 = 1 mA or V      |

## 160 Parameters

| No.   | Name/Value                    | Description   | Def/FbEq16   |
|-------|-------------------------------|---|--|
| 12.19 | <i>AI1 scaled at AI1 min</i>  | <p>Defines the real internal value that corresponds to the minimum analog input AI1 value defined by parameter <a href="#">12.17 AI1 min</a>. (Changing the polarity settings of <a href="#">12.19</a> and <a href="#">12.20</a> can effectively invert the analog input.)</p>  | 0.000  |
|       | -32768.000 ...<br>32767.000   | Real value corresponding to minimum AI1 value.  | 1 = 1  |
| 12.20 | <i>AI1 scaled at AI1 max</i>  | <p>Defines the real internal value that corresponds to the maximum analog input AI1 value defined by parameter <a href="#">12.18 AI1 max</a>. See the drawing at parameter <a href="#">12.19 AI1 scaled at AI1 min</a>.</p>   | 1500.000;<br>1800.000<br>( <a href="#">95.20</a> b0) |
|       | -32768.000 ...<br>32767.000   | Real value corresponding to maximum AI1 value.  | 1 = 1  |
| 12.21 | <i>AI2 actual value</i>       | <p>Displays the value of analog input AI2 in mA or V (depending on whether the input is set to current or voltage by a hardware setting).<br/>This parameter is read-only.</p>  | -  |
|       | -22.000 ... 22.000<br>mA or V | Value of analog input AI2.  | 1000 = 1 mA<br>or V                                  |
| 12.22 | <i>AI2 scaled value</i>       | <p>Displays the value of analog input AI2 after scaling. See parameters <a href="#">12.29 AI2 scaled at AI2 min</a> and <a href="#">12.30 AI2 scaled at AI2 max</a>.<br/>This parameter is read-only.</p>   | -  |
|       | -32768.000 ...<br>32767.000   | Scaled value of analog input AI2.   | 1 = 1  |
| 12.25 | <i>AI2 unit selection</i>     | <p>Selects the unit for readings and settings related to analog input AI2.<br/><b>Note:</b> This setting must match the corresponding hardware setting on the drive control unit (see the hardware manual of the drive). Control board reboot (either by cycling the power or through parameter <a href="#">96.08 Control board boot</a>) is required to validate any changes in the hardware settings.</p> | <i>mA</i>  |
|       | V                             | Volts.  | 2  |
|       | mA                            | Milliamperes.   | 10   |
| 12.26 | <i>AI2 filter time</i>        | <p>Defines the filter time constant for analog input AI2. See parameter <a href="#">12.16 AI1 filter time</a>.</p>  | 0.100 s  |
|       | 0.000 ... 30.000 s            | Filter time constant.   | 1000 = 1 s   |

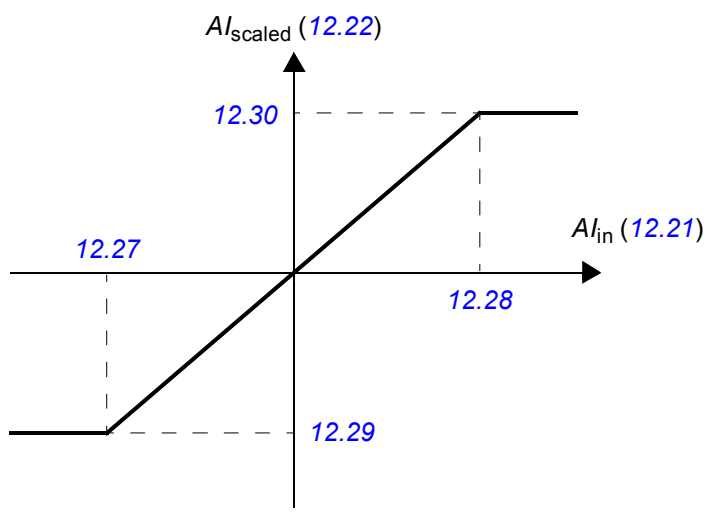

| No.                   | Name/Value                   | Description   | Def/FbEq16              |
|-----------------------|------------------------------|---|-------------------------|
| 12.27                 | <i>AI2 min</i>               | Defines the minimum site value for analog input AI2.<br>Set the value actually sent to the drive when the analog signal from plant is wound to its minimum setting.<br>See also parameter <a href="#">12.01 AI tune</a> .   | 0.000 mA or V           |
|                       | -22.000 ... 22.000 mA or V   | Minimum value of AI2.   | 1000 = 1 mA or V        |
| 12.28                 | <i>AI2 max</i>               | Defines the maximum site value for analog input AI2.<br>Set the value actually sent to the drive when the analog signal from plant is wound to its maximum setting.<br>See also parameter <a href="#">12.01 AI tune</a> .   | 20.000 mA or 10.000 V   |
|                       | -22.000 ... 22.000 mA or V   | Maximum value of AI2.   | 1000 = 1 mA or V        |
| 12.29                 | <i>AI2 scaled at AI2 min</i> | Defines the real value that corresponds to the minimum analog input AI2 value defined by parameter <a href="#">12.27 AI2 min</a> .<br>(Changing the polarity settings of <a href="#">12.29</a> and <a href="#">12.30</a> can effectively invert the analog input.)<br> | 0.000                   |
|                       | -32768.000 ... 32767.000     | Real value corresponding to minimum AI2 value.  | 1 = 1                   |
| 12.30                 | <i>AI2 scaled at AI2 max</i> | Defines the real value that corresponds to the maximum analog input AI2 value defined by parameter <a href="#">12.28 AI2 max</a> .<br>See the drawing at parameter <a href="#">12.29 AI2 scaled at AI2 min</a> .  | 100.000                 |
|                       | -32768.000 ... 32767.000     | Real value corresponding to maximum AI2 value.  | 1 = 1                   |
| <b>13 Standard AO</b> |                              | Configuration of standard analog outputs.   |                         |
| 13.11                 | <i>AO1 actual value</i>      | Displays the value of AO1 in mA.<br>This parameter is read-only.  | -                       |
|                       | 0.000 ... 22.000 mA          | Value of AO1.   | 1000 = 1 mA             |
| 13.12                 | <i>AO1 source</i>            | Selects a signal to be connected to analog output AO1.<br>Alternatively, sets the output to excitation mode to feed a constant current to a temperature sensor.   | <i>Motor speed used</i> |
|                       | Zero                         | None.   | 0                       |
|                       | Motor speed used             | <a href="#">01.01 Motor speed used</a> (page 115).  | 1                       |
|                       | Output frequency             | <a href="#">01.06 Output frequency</a> (page 115).  | 3                       |
|                       | Motor current                | <a href="#">01.07 Motor current</a> (page 115).   | 4                       |

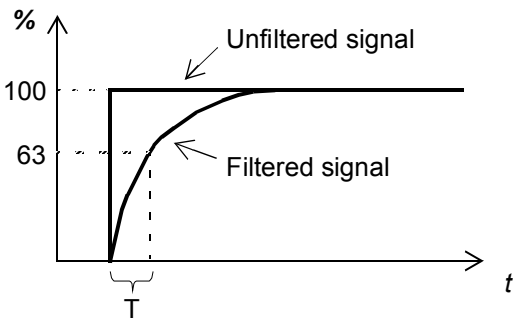
| No.   | Name/Value              | Description  | Def/FbEq16 |
|-------|-------------------------|--|------------|
|       | Motor torque            | <a href="#">01.10 Motor torque</a> (page 115).   | 6          |
|       | DC voltage              | <a href="#">01.11 DC voltage</a> (page 115).   | 7          |
|       | Power inu out           | <a href="#">01.14 Output power</a> (page 116).   | 8          |
|       | Speed ref ramp in       | <a href="#">23.01 Speed ref ramp input</a> (page 218).   | 10         |
|       | Speed ref ramp out      | <a href="#">23.02 Speed ref ramp output</a> (page 218).  | 11         |
|       | Speed ref used          | <a href="#">24.01 Used speed reference</a> (page 224).   | 12         |
|       | Torq ref used           | <a href="#">26.02 Torque reference used</a> (page 240).  | 13         |
|       | Freq ref used           | <a href="#">28.02 Frequency ref ramp output</a> (page 246).  | 14         |
|       | Process PID out         | <a href="#">40.01 Process PID output actual</a> (page 301).  | 16         |
|       | Process PID fbk         | <a href="#">40.02 Process PID feedback actual</a> (page 301).  | 17         |
|       | Process PID act         | <a href="#">40.03 Process PID setpoint actual</a> (page 301).  | 18         |
|       | Process PID dev         | <a href="#">40.04 Process PID deviation actual</a> (page 301).   | 19         |
|       | Force Pt100 excitation  | The output is used to feed an excitation current to 1...3 Pt100 sensors. See section <a href="#">Motor thermal protection</a> (page 80).   | 20         |
|       | Force KTY84 excitation  | The output is used to feed an excitation current to a KTY84 sensor. See section <a href="#">Motor thermal protection</a> (page 80).  | 21         |
|       | Force PTC excitation    | The output is used to feed an excitation current to 1...3 PTC sensors. See section <a href="#">Motor thermal protection</a> (page 80).   | 22         |
|       | Force Pt1000 excitation | The output is used to feed an excitation current to 1...3 Pt1000 sensors. See section <a href="#">Motor thermal protection</a> (page 80).  | 23         |
|       | AO1 data storage        | <a href="#">13.91 AO1 data storage</a> (page 165).   | 37         |
|       | AO2 data storage        | <a href="#">13.92 AO2 data storage</a> (page 165).   | 38         |
|       | <i>Other</i>            | Source selection (see <a href="#">Terms and abbreviations</a> on page 112).  | -          |
| 13.16 | <i>AO1 filter time</i>  | <p>Defines the filtering time constant for analog output AO1.</p>  <p><math>O = I \times (1 - e^{-t/T})</math></p> <p>I = filter input (step)<br/> O = filter output<br/> t = time<br/> T = filter time constant</p> | 0.100 s    |
|       | 0.000 ... 30.000 s      | Filter time constant.  | 1000 = 1 s |

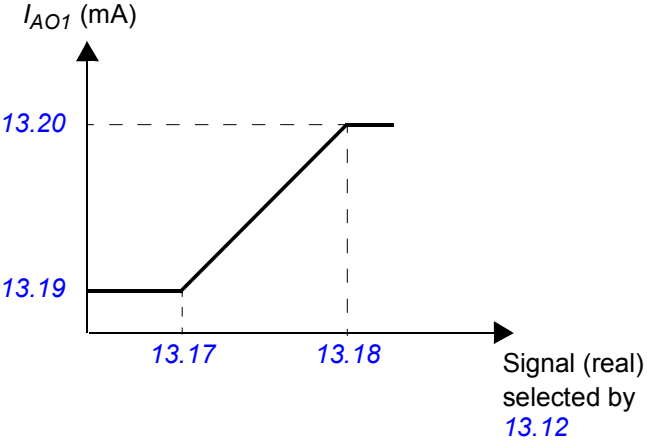
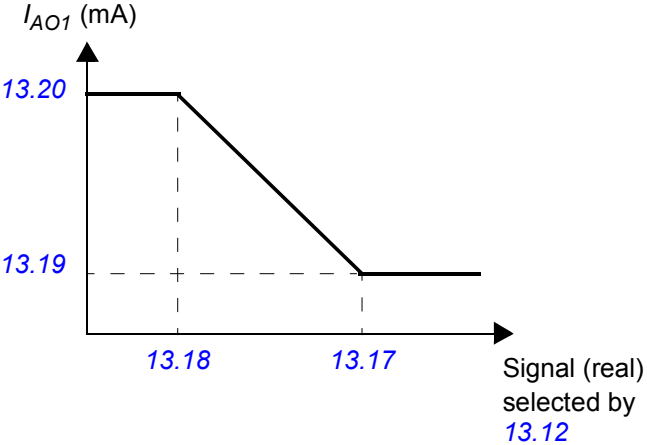
| No.   | Name/Value                    | Description   | Def/FbEq16                                       |
|-------|-------------------------------|---|--|
| 13.17 | <i>AO1 source min</i>         | Defines the real minimum value of the signal (selected by parameter <a href="#">13.12 AO1 source</a> ) that corresponds to the minimum required AO1 output value (defined by parameter <a href="#">13.19 AO1 out at AO1 src min</a> ).<br><br><br><br>Programming <a href="#">13.17</a> as the maximum value and <a href="#">13.18</a> as the minimum value inverts the output.<br><br> | 0.0  |
|       | -32768.0 ...<br>32767.0       | Real signal value corresponding to minimum AO1 output value.  | 1 = 1  |
| 13.18 | <i>AO1 source max</i>         | Defines the real maximum value of the signal (selected by parameter <a href="#">13.12 AO1 source</a> ) that corresponds to the maximum required AO1 output value (defined by parameter <a href="#">13.20 AO1 out at AO1 src max</a> ). See parameter <a href="#">13.17 AO1 source min</a> .   | 1500.0;<br>1800.0<br>( <a href="#">95.20</a> b0) |
|       | -32768.0 ...<br>32767.0       | Real signal value corresponding to maximum AO1 output value.  | 1 = 1  |
| 13.19 | <i>AO1 out at AO1 src min</i> | Defines the minimum output value for analog output AO1. See also drawing at parameter <a href="#">13.17 AO1 source min</a> .  | 0.000 mA   |
|       | 0.000 ... 22.000 mA           | Minimum AO1 output value.   | 1000 = 1 mA                                      |
| 13.20 | <i>AO1 out at AO1 src max</i> | Defines the maximum output value for analog output AO1. See also drawing at parameter <a href="#">13.17 AO1 source min</a> .  | 20.000 mA  |
|       | 0.000 ... 22.000 mA           | Maximum AO1 output value.   | 1000 = 1 mA                                      |

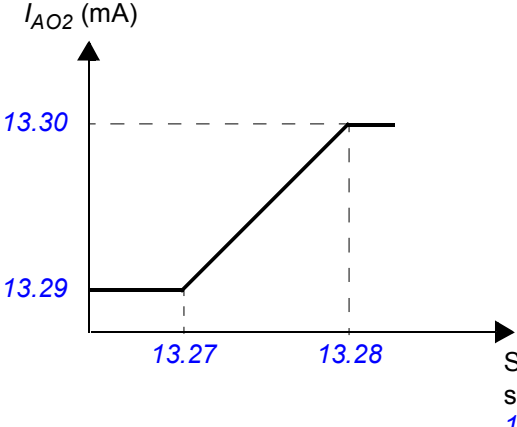
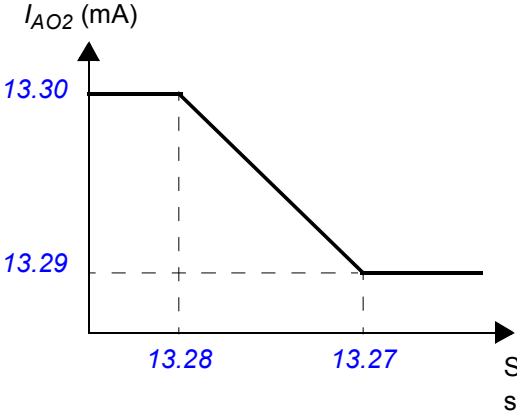
| No.   | Name/Value              | Description  | Def/FbEq16           |
|-------|-------------------------|--|----------------------|
| 13.21 | <i>AO2 actual value</i> | Displays the value of AO2 in mA.<br>This parameter is read-only.   | -                    |
|       | 0.000 ... 22.000 mA     | Value of AO2.  | 1000 = 1 mA          |
| 13.22 | <i>AO2 source</i>       | Selects a signal to be connected to analog output AO2.<br>Alternatively, sets the output to excitation mode to feed a constant current to a temperature sensor.<br>For the selections, see parameter <i>13.12 AO1 source</i> . | <i>Motor current</i> |
| 13.26 | <i>AO2 filter time</i>  | Defines the filtering time constant for analog output AO2. See parameter <i>13.16 AO1 filter time</i> .  | 0.100 s              |
|       | 0.000 ... 30.000 s      | Filter time constant.  | 1000 = 1 s           |
| 13.27 | <i>AO2 source min</i>   | Defines the real minimum value of the signal (selected by parameter <i>13.22 AO2 source</i> ) that corresponds to the minimum required AO2 output value (defined by parameter <i>13.29 AO2 out at AO2 src min</i> ).           | 0.0                  |
|       |                         |  <p style="text-align: right;">Signal (real)<br/>selected by<br/>13.22</p>  |                      |
|       |                         | Programming <i>13.27</i> as the maximum value and <i>13.28</i> as the minimum value inverts the output.  |                      |
|       |                         |  <p style="text-align: right;">Signal (real)<br/>selected by<br/>13.22</p>   |                      |
|       | -32768.0 ...<br>32767.0 | Real signal value corresponding to minimum AO2 output value.   | 1 = 1                |



| No.                              | Name/Value                    | Description   | Def/FbEq16    |
|----------------------------------|-------------------------------|---|---------------|
| 13.28                            | <i>AO2 source max</i>         | Defines the real maximum value of the signal (selected by parameter <i>13.22 AO2 source</i> ) that corresponds to the maximum required AO2 output value (defined by parameter <i>13.30 AO2 out at AO2 src max</i> ). See parameter <i>13.27 AO2 source min</i> .  | 100.0         |
|                                  | -32768.0 ...<br>32767.0       | Real signal value corresponding to maximum AO2 output value.  | 1 = 1         |
| 13.29                            | <i>AO2 out at AO2 src min</i> | Defines the minimum output value for analog output AO2. See also drawing at parameter <i>13.27 AO2 source min</i> .   | 0.000 mA      |
|                                  | 0.000 ... 22.000 mA           | Minimum AO2 output value.   | 1000 = 1 mA   |
| 13.30                            | <i>AO2 out at AO2 src max</i> | Defines the maximum output value for analog output AO2. See also drawing at parameter <i>13.27 AO2 source min</i> .   | 20.000 mA     |
|                                  | 0.000 ... 22.000 mA           | Maximum AO2 output value.   | 1000 = 1 mA   |
| 13.91                            | <i>AO1 data storage</i>       | Storage parameter for controlling analog output AO1 eg. through fieldbus.<br>In <i>13.12 AO1 source</i> , select <i>AO1 data storage</i> . Then set this parameter as the target of the incoming value data.<br>With the embedded fieldbus interface, simply set the target selection parameter of that particular data ( <i>58.101...58.124</i> ) to <i>AO1 data storage</i> . | 0.00          |
|                                  | -327.68 ... 327.67            | Storage parameter for AO1.  | 100 = 1       |
| 13.92                            | <i>AO2 data storage</i>       | Storage parameter for controlling analog output AO2 eg. through fieldbus.<br>In <i>13.22 AO2 source</i> , select <i>AO2 data storage</i> . Then set this parameter as the target of the incoming value data.<br>With the embedded fieldbus interface, simply set the target selection parameter of that particular data ( <i>58.101...58.124</i> ) to <i>AO2 data storage</i> . | 0.00          |
|                                  | -327.68 ... 327.67            | Storage parameter for AO2.  | 100 = 1       |
| <b>14 I/O extension module 1</b> |                               | Configuration of I/O extension module 1.<br>See also section <i>Programmable I/O extensions</i> (page 29).<br><b>Note:</b> The contents of the parameter group vary according to the selected I/O extension module type.  |               |
| 14.01                            | <i>Module 1 type</i>          | Activates (and specifies the type of) I/O extension module 1.   | <i>None</i>   |
|                                  | None                          | Inactive.   | 0             |
|                                  | FIO-01                        | FIO-01.   | 1             |
|                                  | FIO-11                        | FIO-11.   | 2             |
|                                  | FDIO-01                       | FDIO-01.  | 3             |
|                                  | FAIO-01                       | FAIO-01.  | 4             |
| 14.02                            | <i>Module 1 location</i>      | Specifies the slot (1...3) on the control unit of the drive into which the I/O extension module is installed. Alternatively, specifies the node ID of the slot on an FEA-03 extension adapter.  | <i>Slot 1</i> |
|                                  | Slot 1                        | Slot 1.   | 1             |
|                                  | Slot 2                        | Slot 2.   | 2             |
|                                  | Slot 3                        | Slot 3.   | 3             |
|                                  | 4...254                       | Node ID of the slot on the FEA-03 extension adapter.  | 1 = 1         |

| No.   | Name/Value                | Description  | Def/FbEq16       |
|-------|---------------------------|--|------------------|
| 14.03 | <i>Module 1 status</i>    | Displays the status of I/O extension module 1.   | <i>No option</i> |
|       | No option                 | No module detected in the specified slot.  | 0                |
|       | No communication          | A module has been detected but cannot be communicated with.  | 1                |
|       | Unknown                   | The module type is unknown.  | 2                |
|       | FIO-01                    | An FIO-01 module has been detected and is active.  | 15               |
|       | FIO-11                    | An FIO-11 module has been detected and is active.  | 20               |
|       | FAIO-01                   | An FAIO-01 module has been detected and is active.   | 24               |
| 14.05 | <i>DI status</i>          | <i>(Visible when 14.01 Module 1 type = FDIO-01)</i><br>Displays the status of the digital inputs on the extension module. The activation/deactivation delays (if any are specified) are ignored. A filtering time (for input mode) can be defined by parameter <i>14.08 DI filter time</i> .<br>Bit 0 indicates the status of DI1.<br><b>Note:</b> The number of active bits in this parameter depends on the number of digital input/outputs on the extension module.<br><b>Example:</b> 0101b = DI1 and DI3 are on, remainder are off.<br>This parameter is read-only.                     | -                |
|       | 0000b...1111b             | Status of digital inputs.  | 1 = 1            |
| 14.05 | <i>DIO status</i>         | <i>(Visible when 14.01 Module 1 type = FIO-01 or FIO-11)</i><br>Displays the status of the digital input/outputs on the extension module. The activation/deactivation delays (if any are specified) are ignored. A filtering time (for input mode) can be defined by parameter <i>14.08 DIO filter time</i> .<br>Bit 0 indicates the status of DIO1.<br><b>Note:</b> The number of active bits in this parameter depends on the number of digital input/outputs on the extension module.<br><b>Example:</b> 1001b = DIO1 and DIO4 are on, remainder are off.<br>This parameter is read-only. | -                |
|       | 0000b...1111b             | Status of digital input/outputs.   | 1 = 1            |
| 14.06 | <i>DI delayed status</i>  | <i>(Visible when 14.01 Module 1 type = FDIO-01)</i><br>Displays the delayed status of the digital inputs on the extension module. The word is updated only after activation/deactivation delays (if any are specified).<br>Bit 0 indicates the status of DI1.<br><b>Note:</b> The number of active bits in this parameter depends on the number of digital inputs on the extension module.<br><b>Example:</b> 0101b = DI1 and DI3 are on, remainder are off.<br>This parameter is read-only.   | -                |
|       | 0000b...1111b             | Delayed status of digital inputs.  | 1 = 1            |
| 14.06 | <i>DIO delayed status</i> | <i>(Visible when 14.01 Module 1 type = FIO-01 or FIO-11)</i><br>Displays the delayed status of the digital input/outputs on the extension module. This word is updated only after activation/deactivation delays (if any are specified).<br>Bit 0 indicates the status of DIO1.<br><b>Note:</b> The number of active bits in this parameter depends on the number of digital input/outputs on the extension module.<br><b>Example:</b> 1001b = DIO1 and DIO4 are on, remainder are off.<br>This parameter is read-only.  | -                |
|       | 0000b...1111b             | Delayed status of digital input/outputs.   | 1 = 1            |

| No.   | Name/Value                | Description   | Def/FbEq16           |
|-------|---------------------------|---|----------------------|
| 14.08 | <i>DI filter time</i>     | (Visible when 14.01 Module 1 type = <i>FDIO-01</i> )<br>Defines a filtering time for parameter <i>14.05 DI status</i> .   | 10.0 ms              |
|       | 0.8 ... 100.0 ms          | Filtering time for <i>14.05</i> .   | 10 = 1 ms            |
| 14.08 | <i>DIO filter time</i>    | (Visible when 14.01 Module 1 type = <i>FIO-01</i> or <i>FIO-11</i> )<br>Defines a filtering time for parameter <i>14.05 DIO status</i> . The filtering time will only affect the DIOs that are in input mode.                           | 10.0 ms              |
|       | 0.8 ... 100.0 ms          | Filtering time for <i>14.05</i> .   | 10 = 1 ms            |
| 14.09 | <i>DIO1 function</i>      | (Visible when 14.01 Module 1 type = <i>FIO-01</i> or <i>FIO-11</i> )<br>Selects whether DIO1 of the extension module is used as a digital input or output.  | <i>Input</i>         |
|       | Output                    | DIO1 is used as a digital output.   | 0                    |
|       | Input                     | DIO1 is used as a digital input.  | 1                    |
| 14.11 | <i>DIO1 output source</i> | (Visible when 14.01 Module 1 type = <i>FIO-01</i> or <i>FIO-11</i> )<br>Selects a drive signal to be connected to digital input/output DIO1 of the extension module when parameter <i>14.09 DIO1 function</i> is set to <i>Output</i> . | <i>Not energized</i> |
|       | Not energized             | Output is not energized.  | 0                    |
|       | Energized                 | Output is energized.  | 1                    |
|       | Ready run                 | Bit 1 of <i>06.11 Main status word</i> (see page 129).  | 2                    |
|       | Enabled                   | Bit 0 of <i>06.16 Drive status word 1</i> (see page 130).   | 4                    |
|       | Started                   | Bit 5 of <i>06.16 Drive status word 1</i> (see page 130).   | 5                    |
|       | Magnetized                | Bit 1 of <i>06.17 Drive status word 2</i> (see page 131).   | 6                    |
|       | Running                   | Bit 6 of <i>06.16 Drive status word 1</i> (see page 130).   | 7                    |
|       | Ready ref                 | Bit 2 of <i>06.11 Main status word</i> (see page 129).  | 8                    |
|       | At setpoint               | Bit 8 of <i>06.11 Main status word</i> (see page 129).  | 9                    |
|       | Reverse                   | Bit 2 of <i>06.19 Speed control status word</i> (see page 133).   | 10                   |
|       | Zero speed                | Bit 0 of <i>06.19 Speed control status word</i> (see page 133).   | 11                   |
|       | Above limit               | Bit 10 of <i>06.17 Drive status word 2</i> (see page 131).  | 12                   |
|       | Warning                   | Bit 7 of <i>06.11 Main status word</i> (see page 129).  | 13                   |
|       | Fault                     | Bit 3 of <i>06.11 Main status word</i> (see page 129).  | 14                   |
|       | Fault (-1)                | Inverted bit 3 of <i>06.11 Main status word</i> (see page 129).   | 15                   |
|       | Open brake command        | Bit 0 of <i>44.01 Brake control status</i> (see page 317).  | 22                   |
|       | Ext2 active               | Bit 11 of <i>06.16 Drive status word 1</i> (see page 130).  | 23                   |
|       | Remote control            | Bit 9 of <i>06.11 Main status word</i> (see page 129).  | 24                   |
|       | Supervision 1             | Bit 0 of <i>32.01 Supervision status</i> (see page 273).  | 33                   |
|       | Supervision 2             | Bit 1 of <i>32.01 Supervision status</i> (see page 273).  | 34                   |
|       | Supervision 3             | Bit 2 of <i>32.01 Supervision status</i> (see page 273).  | 35                   |
|       | RO/DIO control word bit0  | Bit 0 of <i>10.99 RO/DIO control word</i> (see page 152).   | 40                   |
|       | RO/DIO control word bit1  | Bit 1 of <i>10.99 RO/DIO control word</i> (see page 152).   | 41                   |
|       | RO/DIO control word bit2  | Bit 2 of <i>10.99 RO/DIO control word</i> (see page 152).   | 42                   |

| No.  | Name/Value                     | Description   | Def/FbEq16            |
|--|--------------------------------|---|-----------------------|
|  | RO/DIO control word bit8       | Bit 8 of <a href="#">10.99 RO/DIO control word</a> (see page 152).  | 43                    |
|  | RO/DIO control word bit9       | Bit 9 of <a href="#">10.99 RO/DIO control word</a> (see page 152).  | 44                    |
|  | <a href="#">Other [bit]</a>    | Source selection (see <a href="#">Terms and abbreviations</a> on page 112).   | -                     |
| <a href="#">14.12</a>  | <a href="#">DI1 ON delay</a>   | (Visible when <a href="#">14.01 Module 1 type</a> = <a href="#">FDIO-01</a> )<br>Defines the activation delay for digital input DI1.  | 0.00 s                |
| <p><math>t_{On}</math> = <a href="#">14.12 DI1 ON delay</a><br/> <math>t_{Off}</math> = <a href="#">14.13 DI1 OFF delay</a><br/> *Electrical status of DI or status of selected source (in output mode). Indicated by <a href="#">14.05 DI status</a>.<br/> **Indicated by <a href="#">14.06 DI delayed status</a>.</p>                      |                                |   |                       |
|  | 0.00 ... 3000.00 s             | Activation delay for DI1.   | 10 = 1 s              |
| <a href="#">14.12</a>  | <a href="#">DIO1 ON delay</a>  | (Visible when <a href="#">14.01 Module 1 type</a> = <a href="#">FIO-01</a> or <a href="#">FIO-11</a> )<br>Defines the activation delay for digital input/output DIO1.   | 0.00 s                |
| <p><math>t_{On}</math> = <a href="#">14.12 DIO1 ON delay</a><br/> <math>t_{Off}</math> = <a href="#">14.13 DIO1 OFF delay</a><br/> *Electrical status of DIO (in input mode) or status of selected source (in output mode). Indicated by <a href="#">14.05 DIO status</a>.<br/> **Indicated by <a href="#">14.06 DIO delayed status</a>.</p> |                                |   |                       |
|  | 0.00 ... 3000.00 s             | Activation delay for DIO1.  | 10 = 1 s              |
| <a href="#">14.13</a>  | <a href="#">DI1 OFF delay</a>  | (Visible when <a href="#">14.01 Module 1 type</a> = <a href="#">FDIO-01</a> )<br>Defines the deactivation delay for digital input DI1. See parameter <a href="#">14.12 DI1 ON delay</a> .                                   | 0.00 s                |
|  | 0.00 ... 3000.00 s             | Deactivation delay for DI1.   | 10 = 1 s              |
| <a href="#">14.13</a>  | <a href="#">DIO1 OFF delay</a> | (Visible when <a href="#">14.01 Module 1 type</a> = <a href="#">FIO-01</a> or <a href="#">FIO-11</a> )<br>Defines the deactivation delay for digital input/output DIO1. See parameter <a href="#">14.12 DIO1 ON delay</a> . | 0.00 s                |
|  | 0.00 ... 3000.00 s             | Deactivation delay for DIO1.  | 10 = 1 s              |
| <a href="#">14.14</a>  | <a href="#">DIO2 function</a>  | (Visible when <a href="#">14.01 Module 1 type</a> = <a href="#">FIO-01</a> or <a href="#">FIO-11</a> )<br>Selects whether DIO2 of the extension module is used as a digital input or output.                                | <a href="#">Input</a> |
|  | Output                         | DIO2 is used as a digital output.   | 0                     |



| No.   | Name/Value                     | Description   | Def/FbEq16    |
|-------|--------------------------------|---|---------------|
|       | Input                          | DIO2 is used as a digital input.  | 1             |
| 14.16 | <i>DIO2 output source</i>      | (Visible when 14.01 Module 1 type = FIO-01 or FIO-11)<br>Selects a drive signal to be connected to digital input/output DIO2 when parameter 14.14 <i>DIO2 function</i> is set to <i>Output</i> .<br>For the available selections, see parameter 14.11 <i>DIO1 output source</i> .   | Not energized |
| 14.17 | <i>DI2 ON delay</i>            | (Visible when 14.01 Module 1 type = FDIO-01)<br>Defines the activation delay for digital input DI2. See parameter 14.12 <i>DI1 ON delay</i> .   | 0.00 s        |
|       | 0.00 ... 3000.00 s             | Activation delay for DI2.   | 10 = 1 s      |
| 14.17 | <i>DIO2 ON delay</i>           | (Visible when 14.01 Module 1 type = FIO-01 or FIO-11)<br>Defines the activation delay for digital input/output DIO2. See parameter 14.12 <i>DIO1 ON delay</i> .   | 0.00 s        |
|       | 0.00 ... 3000.00 s             | Activation delay for DIO2.  | 10 = 1 s      |
| 14.18 | <i>DI2 OFF delay</i>           | (Visible when 14.01 Module 1 type = FDIO-01)<br>Defines the deactivation delay for digital input DI2. See parameter 14.12 <i>DI1 ON delay</i> .   | 0.00 s        |
|       | 0.00 ... 3000.00 s             | Deactivation delay for DI2.   | 10 = 1 s      |
| 14.18 | <i>DIO2 OFF delay</i>          | (Visible when 14.01 Module 1 type = FIO-01 or FIO-11)<br>Defines the deactivation delay for digital input/output DIO2. See parameter 14.12 <i>DIO1 ON delay</i> .   | 0.00 s        |
|       | 0.00 ... 3000.00 s             | Deactivation delay for DIO2.  | 10 = 1 s      |
| 14.19 | <i>DIO3 function</i>           | (Visible when 14.01 Module 1 type = FIO-01)<br>Selects whether DIO3 of the extension module is used as a digital input or output.   | Input         |
|       | Output                         | DIO3 is used as a digital output.   | 0             |
|       | Input                          | DIO3 is used as a digital input.  | 1             |
| 14.19 | <i>AI supervision function</i> | (Visible when 14.01 Module 1 type = FIO-11 or FAIO-01)<br>Selects how the drive reacts when an analog input signal moves out of the minimum and/or maximum limits specified for the input.<br>The inputs and the limits to be observed are selected by parameter 14.20 <i>AI supervision selection</i> .  | No action     |
|       | No action                      | No action taken.  | 0             |
|       | Fault                          | Drive trips on <i>80A0 AI supervision</i> .   | 1             |
|       | Warning                        | Drive generates an <i>A8A0 AI supervision</i> warning.  | 2             |
|       | Last speed                     | Drive generates a warning ( <i>A8A0 AI supervision</i> ) and freezes the speed (or frequency) to the level the drive was operating at. The speed/frequency is determined on the basis of actual speed using 850 ms low-pass filtering.<br> <b>WARNING!</b> Make sure that it is safe to continue operation in case of a communication break. | 3             |
|       | Speed ref safe                 | Drive generates a warning ( <i>A8A0 AI supervision</i> ) and sets the speed to the speed defined by parameter 22.41 <i>Speed ref safe</i> (or 28.41 <i>Frequency ref safe</i> when frequency reference is being used).<br> <b>WARNING!</b> Make sure that it is safe to continue operation in case of a communication break.                 | 4             |

## 170 Parameters

| No.   | Name/Value                      | Description   | Def/FbEq16           |     |      |             |   |           |  |   |           |  |   |           |  |   |           |  |   |           |  |   |           |  |        |          |  |
|---|---------------------------------|---|----------------------|-----|------|-------------|---|-----------|--|---|-----------|--|---|-----------|--|---|-----------|--|---|-----------|--|---|-----------|--|--------|----------|--|
| 14.20   | <i>AI supervision selection</i> | <p>(Visible when <i>14.01 Module 1 type = FIO-11 or FAIO-01</i>)</p> <p>Specifies the analog input limits to be supervised. See parameter <i>14.19 AI supervision function</i>.</p> <p><b>Note:</b> The number of active bits in this parameter depends on the number of inputs on the extension module.</p>  | 0000 0000b           |     |      |             |   |           |  |   |           |  |   |           |  |   |           |  |   |           |  |   |           |  |        |          |  |
| <table border="1"> <thead> <tr> <th>Bit</th> <th>Name</th> <th>Description</th> </tr> </thead> <tbody> <tr> <td>0</td> <td>AI1 &lt; MIN</td> <td>1 = Minimum limit supervision of AI1 active.</td> </tr> <tr> <td>1</td> <td>AI1 &gt; MAX</td> <td>1 = Maximum limit supervision of AI1 active.</td> </tr> <tr> <td>2</td> <td>AI2 &lt; MIN</td> <td>1 = Minimum limit supervision of AI2 active.</td> </tr> <tr> <td>3</td> <td>AI2 &gt; MAX</td> <td>1 = Maximum limit supervision of AI2 active.</td> </tr> <tr> <td>4</td> <td>AI3 &lt; MIN</td> <td>1 = Minimum limit supervision of AI3 active (FIO-11 only).</td> </tr> <tr> <td>5</td> <td>AI3 &gt; MAX</td> <td>1 = Maximum limit supervision of AI3 active (FIO-11 only).</td> </tr> <tr> <td>6...15</td> <td>Reserved</td> <td></td> </tr> </tbody> </table> |                                 |   |                      | Bit | Name | Description | 0 | AI1 < MIN | 1 = Minimum limit supervision of AI1 active. | 1 | AI1 > MAX | 1 = Maximum limit supervision of AI1 active. | 2 | AI2 < MIN | 1 = Minimum limit supervision of AI2 active. | 3 | AI2 > MAX | 1 = Maximum limit supervision of AI2 active. | 4 | AI3 < MIN | 1 = Minimum limit supervision of AI3 active (FIO-11 only). | 5 | AI3 > MAX | 1 = Maximum limit supervision of AI3 active (FIO-11 only). | 6...15 | Reserved |  |
| Bit   | Name                            | Description   |                      |     |      |             |   |           |  |   |           |  |   |           |  |   |           |  |   |           |  |   |           |  |        |          |  |
| 0   | AI1 < MIN                       | 1 = Minimum limit supervision of AI1 active.  |                      |     |      |             |   |           |  |   |           |  |   |           |  |   |           |  |   |           |  |   |           |  |        |          |  |
| 1   | AI1 > MAX                       | 1 = Maximum limit supervision of AI1 active.  |                      |     |      |             |   |           |  |   |           |  |   |           |  |   |           |  |   |           |  |   |           |  |        |          |  |
| 2   | AI2 < MIN                       | 1 = Minimum limit supervision of AI2 active.  |                      |     |      |             |   |           |  |   |           |  |   |           |  |   |           |  |   |           |  |   |           |  |        |          |  |
| 3   | AI2 > MAX                       | 1 = Maximum limit supervision of AI2 active.  |                      |     |      |             |   |           |  |   |           |  |   |           |  |   |           |  |   |           |  |   |           |  |        |          |  |
| 4   | AI3 < MIN                       | 1 = Minimum limit supervision of AI3 active (FIO-11 only).  |                      |     |      |             |   |           |  |   |           |  |   |           |  |   |           |  |   |           |  |   |           |  |        |          |  |
| 5   | AI3 > MAX                       | 1 = Maximum limit supervision of AI3 active (FIO-11 only).  |                      |     |      |             |   |           |  |   |           |  |   |           |  |   |           |  |   |           |  |   |           |  |        |          |  |
| 6...15  | Reserved                        |   |                      |     |      |             |   |           |  |   |           |  |   |           |  |   |           |  |   |           |  |   |           |  |        |          |  |
|   | 0000 0000b ...<br>0011 1111b    | Activation of analog input supervision.   | 1 = 1                |     |      |             |   |           |  |   |           |  |   |           |  |   |           |  |   |           |  |   |           |  |        |          |  |
| 14.21   | <i>DIO3 output source</i>       | <p>(Visible when <i>14.01 Module 1 type = FIO-01</i>)</p> <p>Selects a drive signal to be connected to digital input/output DIO3 when parameter <i>14.19 DIO3 function</i> is set to <i>Output</i>. For the available selections, see parameter <i>14.11 DIO1 output source</i>.</p>  | <i>Not energized</i> |     |      |             |   |           |  |   |           |  |   |           |  |   |           |  |   |           |  |   |           |  |        |          |  |
| 14.21   | <i>AI tune</i>                  | <p>(Visible when <i>14.01 Module 1 type = FIO-11 or FAIO-01</i>)</p> <p>Triggers the analog input tuning function, which enables the use of actual measurements as the minimum and maximum input values instead of potentially inaccurate estimates. Apply the minimum or maximum signal to the input and select the appropriate tuning function. See also the drawing at parameter <i>14.35 AI1 scaled at AI1 min</i>.</p> | <i>No action</i>     |     |      |             |   |           |  |   |           |  |   |           |  |   |           |  |   |           |  |   |           |  |        |          |  |
|   | No action                       | Tuning action completed or no action has been requested. The parameter automatically reverts to this value after any tuning action.   | 0                    |     |      |             |   |           |  |   |           |  |   |           |  |   |           |  |   |           |  |   |           |  |        |          |  |
|   | AI1 min tune                    | The measured value of AI1 is set as the minimum value of AI1 into parameter <i>14.33 AI1 min</i> .  | 1                    |     |      |             |   |           |  |   |           |  |   |           |  |   |           |  |   |           |  |   |           |  |        |          |  |
|   | AI1 max tune                    | The measured value of AI1 is set as the maximum value of AI1 into parameter <i>14.34 AI1 max</i> .  | 2                    |     |      |             |   |           |  |   |           |  |   |           |  |   |           |  |   |           |  |   |           |  |        |          |  |
|   | AI2 min tune                    | The measured value of AI2 is set as the minimum value of AI2 into parameter <i>14.48 AI2 min</i> .  | 3                    |     |      |             |   |           |  |   |           |  |   |           |  |   |           |  |   |           |  |   |           |  |        |          |  |
|   | AI2 max tune                    | The measured value of AI2 is set as the maximum value of AI2 into parameter <i>14.49 AI2 max</i> .  | 4                    |     |      |             |   |           |  |   |           |  |   |           |  |   |           |  |   |           |  |   |           |  |        |          |  |
|   | AI3 min tune                    | <p>(Visible when <i>14.01 Module 1 type = FIO-11</i>)</p> <p>The measured value of AI3 is set as the minimum value of AI3 into parameter <i>14.63 AI3 min</i>.</p>  | 5                    |     |      |             |   |           |  |   |           |  |   |           |  |   |           |  |   |           |  |   |           |  |        |          |  |
|   | AI3 max tune                    | <p>(Visible when <i>14.01 Module 1 type = FIO-11</i>)</p> <p>The measured value of AI3 is set as the maximum value of AI3 into parameter <i>14.64 AI3 max</i>.</p>  | 6                    |     |      |             |   |           |  |   |           |  |   |           |  |   |           |  |   |           |  |   |           |  |        |          |  |
| 14.22   | <i>DI3 ON delay</i>             | <p>(Visible when <i>14.01 Module 1 type = FDIO-01</i>)</p> <p>Defines the activation delay for digital input DI3. See parameter <i>14.12 DI1 ON delay</i>.</p>  | 0.00 s               |     |      |             |   |           |  |   |           |  |   |           |  |   |           |  |   |           |  |   |           |  |        |          |  |
|   | 0.00 ... 3000.00 s              | Activation delay for DI3.   | 10 = 1 s             |     |      |             |   |           |  |   |           |  |   |           |  |   |           |  |   |           |  |   |           |  |        |          |  |

| No.   | Name/Value                         | Description   | Def/FbEq16           |     |      |             |   |     |  |   |     |  |   |     |   |        |          |  |
|---|------------------------------------|---|----------------------|-----|------|-------------|---|-----|--|---|-----|--|---|-----|---|--------|----------|--|
| 14.22   | <a href="#">DIO3 ON delay</a>      | (Visible when <a href="#">14.01 Module 1 type = FIO-01 or FIO-11</a> )<br>Defines the activation delay for digital input/output DIO3. See parameter <a href="#">14.12 DIO1 ON delay</a> .   | 0.00 s               |     |      |             |   |     |  |   |     |  |   |     |   |        |          |  |
|   | 0.00 ... 3000.00 s                 | Activation delay for DIO3.  | 10 = 1 s             |     |      |             |   |     |  |   |     |  |   |     |   |        |          |  |
| 14.22   | <a href="#">AI force selection</a> | (Visible when <a href="#">14.01 Module 1 type = FIO-11 or FAIO-01</a> )<br>The true readings of the analog inputs can be overridden for eg. testing purposes. A forced value parameter is provided for each analog input, and its value is applied whenever the corresponding bit in this parameter is 1. | 0000b                |     |      |             |   |     |  |   |     |  |   |     |   |        |          |  |
| <table border="1"> <thead> <tr> <th>Bit</th> <th>Name</th> <th>Description</th> </tr> </thead> <tbody> <tr> <td>0</td> <td>AI1</td> <td>1 = Force mode: Force AI1 to value of parameter <a href="#">14.28 AI1 force data</a>.</td> </tr> <tr> <td>1</td> <td>AI2</td> <td>1 = Force mode: Force AI2 to value of parameter <a href="#">14.43 AI2 force data</a>.</td> </tr> <tr> <td>2</td> <td>AI3</td> <td>1 = Force mode: Force AI3 to value of parameter <a href="#">14.58 AI3 force data</a> (FIO-11 only).</td> </tr> <tr> <td>3...15</td> <td>Reserved</td> <td></td> </tr> </tbody> </table> |                                    |   |                      | Bit | Name | Description | 0 | AI1 | 1 = Force mode: Force AI1 to value of parameter <a href="#">14.28 AI1 force data</a> . | 1 | AI2 | 1 = Force mode: Force AI2 to value of parameter <a href="#">14.43 AI2 force data</a> . | 2 | AI3 | 1 = Force mode: Force AI3 to value of parameter <a href="#">14.58 AI3 force data</a> (FIO-11 only). | 3...15 | Reserved |  |
| Bit   | Name                               | Description   |                      |     |      |             |   |     |  |   |     |  |   |     |   |        |          |  |
| 0   | AI1                                | 1 = Force mode: Force AI1 to value of parameter <a href="#">14.28 AI1 force data</a> .  |                      |     |      |             |   |     |  |   |     |  |   |     |   |        |          |  |
| 1   | AI2                                | 1 = Force mode: Force AI2 to value of parameter <a href="#">14.43 AI2 force data</a> .  |                      |     |      |             |   |     |  |   |     |  |   |     |   |        |          |  |
| 2   | AI3                                | 1 = Force mode: Force AI3 to value of parameter <a href="#">14.58 AI3 force data</a> (FIO-11 only).   |                      |     |      |             |   |     |  |   |     |  |   |     |   |        |          |  |
| 3...15  | Reserved                           |   |                      |     |      |             |   |     |  |   |     |  |   |     |   |        |          |  |
|   | 0000b...0111b                      | Forced values selector for analog inputs.   | 1 = 1                |     |      |             |   |     |  |   |     |  |   |     |   |        |          |  |
| 14.23   | <a href="#">DI3 OFF delay</a>      | (Visible when <a href="#">14.01 Module 1 type = FDIO-01</a> )<br>Defines the deactivation delay for digital input DI3. See parameter <a href="#">14.12 DI1 ON delay</a> .   | 0.00 s               |     |      |             |   |     |  |   |     |  |   |     |   |        |          |  |
|   | 0.00 ... 3000.00 s                 | Deactivation delay for DI3.   | 10 = 1 s             |     |      |             |   |     |  |   |     |  |   |     |   |        |          |  |
| 14.23   | <a href="#">DIO3 OFF delay</a>     | (Visible when <a href="#">14.01 Module 1 type = FIO-01</a> )<br>Defines the deactivation delay for digital input/output DIO3. See parameter <a href="#">14.12 DIO1 ON delay</a> .   | 0.00 s               |     |      |             |   |     |  |   |     |  |   |     |   |        |          |  |
|   | 0.00 ... 3000.00 s                 | Deactivation delay for DIO3.  | 10 = 1 s             |     |      |             |   |     |  |   |     |  |   |     |   |        |          |  |
| 14.24   | <a href="#">DIO4 function</a>      | (Visible when <a href="#">14.01 Module 1 type = FIO-01</a> )<br>Selects whether DIO4 of the extension module is used as a digital input or output.  | <i>Input</i>         |     |      |             |   |     |  |   |     |  |   |     |   |        |          |  |
|   | Output                             | DIO4 is used as a digital output.   | 0                    |     |      |             |   |     |  |   |     |  |   |     |   |        |          |  |
|   | Input                              | DIO4 is used as a digital input.  | 1                    |     |      |             |   |     |  |   |     |  |   |     |   |        |          |  |
| 14.26   | <a href="#">DIO4 output source</a> | (Visible when <a href="#">14.01 Module 1 type = FIO-01</a> )<br>Selects a drive signal to be connected to digital input/output DIO4 when parameter <a href="#">14.24 DIO4 function</a> is set to <i>Output</i> . For the available selections, see parameter <a href="#">14.11 DIO1 output source</a> .   | <i>Not energized</i> |     |      |             |   |     |  |   |     |  |   |     |   |        |          |  |
| 14.26   | <a href="#">AI1 actual value</a>   | (Visible when <a href="#">14.01 Module 1 type = FIO-11 or FAIO-01</a> )<br>Displays the value of analog input AI1 in mA or V (depending on whether the input is set to current or voltage). This parameter is read-only.  | -                    |     |      |             |   |     |  |   |     |  |   |     |   |        |          |  |
|   | -22.000 ... 22.000 mA or V         | Value of analog input AI1.  | 1000 = 1 mA or V     |     |      |             |   |     |  |   |     |  |   |     |   |        |          |  |
| 14.27   | <a href="#">DIO4 ON delay</a>      | (Visible when <a href="#">14.01 Module 1 type = FIO-01 or FIO-11</a> )<br>Defines the activation delay for digital input/output DIO4. See parameter <a href="#">14.12 DIO1 ON delay</a> .   | 0.00 s               |     |      |             |   |     |  |   |     |  |   |     |   |        |          |  |
|   | 0.00 ... 3000.00 s                 | Activation delay for DIO4.  | 10 = 1 s             |     |      |             |   |     |  |   |     |  |   |     |   |        |          |  |

## 172 Parameters

| No.   | Name/Value                             | Description   | Def/FbEq16          |
|-------|--|---|---------------------|
| 14.27 | <a href="#">AI1 scaled value</a>       | (Visible when <a href="#">14.01 Module 1 type</a> = <a href="#">FIO-11</a> or <a href="#">FAIO-01</a> )<br>Displays the value of analog input AI1 after scaling. See parameter <a href="#">14.35 AI1 scaled at AI1 min</a> .<br>This parameter is read-only.  | -                   |
|       | -32768.000 ...<br>32767.000            | Scaled value of analog input AI1.   | 1 = 1               |
| 14.28 | <a href="#">DIO4 OFF delay</a>         | (Visible when <a href="#">14.01 Module 1 type</a> = <a href="#">FIO-01</a> )<br>Defines the deactivation delay for digital input/output DIO4.<br>See parameter <a href="#">14.12 DIO1 ON delay</a> .  | 0.00 s              |
|       | 0.00 ... 3000.00 s                     | Deactivation delay for DIO4.  | 10 = 1 s            |
| 14.28 | <a href="#">AI1 force data</a>         | (Visible when <a href="#">14.01 Module 1 type</a> = <a href="#">FIO-11</a> or <a href="#">FAIO-01</a> )<br>Forced value that can be used instead of the true reading of the input. See parameter <a href="#">14.22 AI force selection</a> .   | 0.000 mA            |
|       | -22.000 ... 22.000<br>mA or V          | Forced value of analog input AI1.   | 1000 = 1 mA<br>or V |
| 14.29 | <a href="#">AI1 HW switch position</a> | (Visible when <a href="#">14.01 Module 1 type</a> = <a href="#">FIO-11</a> or <a href="#">FAIO-01</a> )<br>Shows the position of the hardware current/voltage selector on the I/O extension module.<br><b>Note:</b> The setting of the current/voltage selector must match the unit selection made in parameter <a href="#">14.30 AI1 unit selection</a> . I/O module reboot either by cycling the power or through parameter <a href="#">96.08 Control board boot</a> is required to validate any changes in the hardware settings.  | -                   |
|       | V                                      | Volts.  | 2                   |
|       | mA                                     | Milliamperes.   | 10                  |
| 14.30 | <a href="#">AI1 unit selection</a>     | (Visible when <a href="#">14.01 Module 1 type</a> = <a href="#">FIO-11</a> or <a href="#">FAIO-01</a> )<br>Selects the unit for readings and settings related to analog input AI1.<br><b>Note:</b> This setting must match the corresponding hardware setting on the I/O extension module (see the manual of the I/O extension module). The hardware setting is shown by parameter <a href="#">14.29 AI1 HW switch position</a> . I/O module reboot either by cycling the power or through parameter <a href="#">96.08 Control board boot</a> is required to validate any changes in the hardware settings. | <i>mA</i>           |
|       | V                                      | Volts.  | 2                   |
|       | mA                                     | Milliamperes.   | 10                  |
| 14.31 | <a href="#">RO status</a>              | (Visible when <a href="#">14.01 Module 1 type</a> = <a href="#">FIO-01</a> or <a href="#">FDIO-01</a> )<br>Status of relay outputs on the I/O extension module.<br><b>Example:</b> 0001b = RO1 is energized, RO2 is de-energized.   | -                   |
|       | 0000b...1111b                          | Status of relay outputs.  | 1 = 1               |
| 14.31 | <a href="#">AI1 filter gain</a>        | (Visible when <a href="#">14.01 Module 1 type</a> = <a href="#">FIO-11</a> or <a href="#">FAIO-01</a> )<br>Selects a hardware filtering time for AI1.<br>See also parameter <a href="#">14.32 AI1 filter time</a> .   | <i>1 ms</i>         |
|       | No filtering                           | No filtering.   | 0                   |
|       | 125 us                                 | 125 microseconds.   | 1                   |
|       | 250 us                                 | 250 microseconds.   | 2                   |
|       | 500 us                                 | 500 microseconds.   | 3                   |
|       | 1 ms                                   | 1 millisecond.  | 4                   |
|       | 2 ms                                   | 2 milliseconds.   | 5                   |

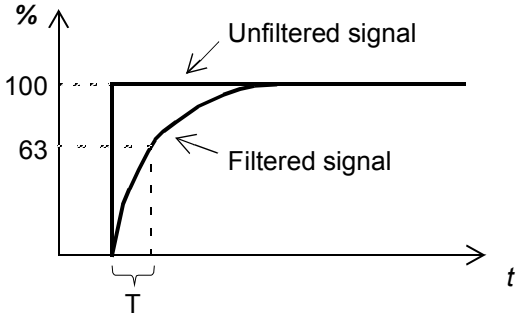
| No.   | Name/Value                 | Description   | Def/FbEq16           |
|-------|----------------------------|---|----------------------|
|       | 4 ms                       | 4 milliseconds.   | 6                    |
|       | 7.9375 ms                  | 7.9375 milliseconds.  | 7                    |
| 14.32 | <i>AI1 filter time</i>     | <p>(Visible when 14.01 Module 1 type = FIO-11 or FAIO-01)<br/>           Defines the filter time constant for analog input AI1.</p>  <p style="text-align: center;"><math>O = I \times (1 - e^{-t/T})</math></p> <p>I = filter input (step)<br/>           O = filter output<br/>           t = time<br/>           T = filter time constant</p> <p><b>Note:</b> The signal is also filtered due to the signal interface hardware. See parameter <a href="#">14.31 AI1 filter gain</a>.</p> | 0.100 s              |
|       | 0.000 ... 30.000 s         | Filter time constant.   | 1000 = 1 s           |
| 14.33 | <i>AI1 min</i>             | <p>(Visible when 14.01 Module 1 type = FIO-11 or FAIO-01)<br/>           Defines the minimum value for analog input AI1.<br/>           See also parameter <a href="#">14.21 AI tune</a>.</p>   | 0.000 mA or V        |
|       | -22.000 ... 22.000 mA or V | Minimum value of AI1.   | 1000 = 1 mA or V     |
| 14.34 | <i>RO1 source</i>          | <p>(Visible when 14.01 Module 1 type = FIO-01 or FDIO-01)<br/>           Selects a drive signal to be connected to relay output RO1.<br/>           For the available selections, see parameter <a href="#">14.11 DIO1 output source</a>.</p>   | <i>Not energized</i> |
| 14.34 | <i>AI1 max</i>             | <p>(Visible when 14.01 Module 1 type = FIO-11 or FAIO-01)<br/>           Defines the maximum value for analog input AI1.<br/>           See also parameter <a href="#">14.21 AI tune</a>.</p>   | 10.000 mA or V       |
|       | -22.000 ... 22.000 mA or V | Maximum value of AI1.   | 1000 = 1 mA or V     |

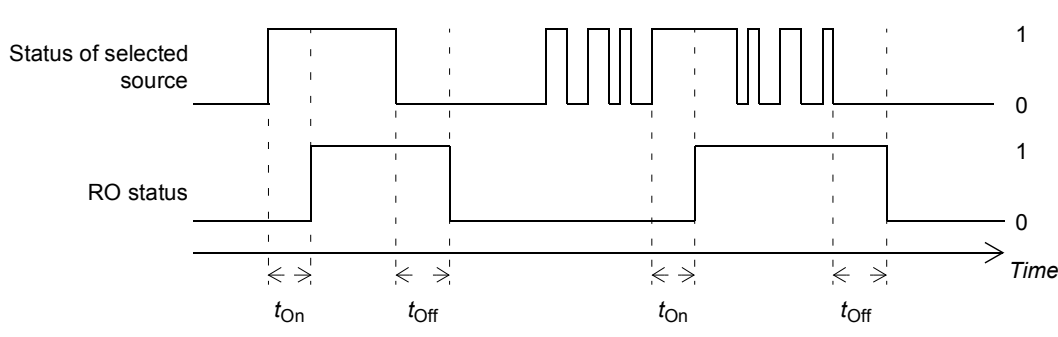
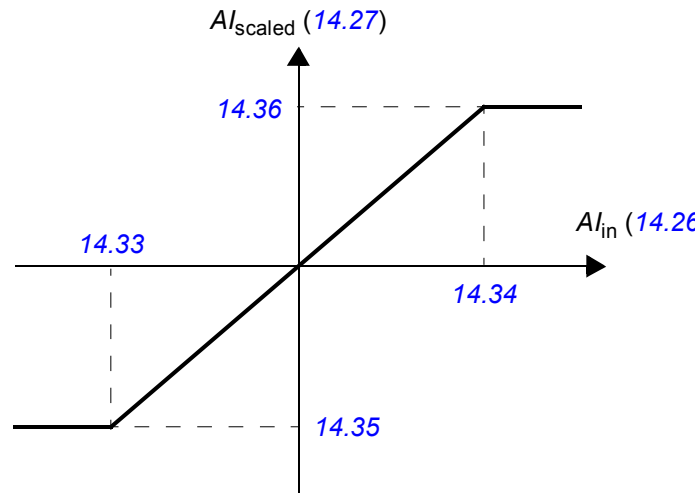
| No.                      | Name/Value                   | Description  | Def/FbEq16    |
|--------------------------|------------------------------|--|---------------|
| 14.35                    | <i>RO1 ON delay</i>          | <p>(Visible when 14.01 Module 1 type = FIO-01 or FDIO-01)</p> <p>Defines the activation delay for relay output RO1.</p>  <p><math>t_{On} = 14.35</math> RO1 ON delay<br/> <math>t_{Off} = 14.36</math> RO1 OFF delay</p> | 0.00 s        |
| 0.00 ... 3000.00 s       |                              | Activation delay for RO1.  | 10 = 1 s      |
| 14.35                    | <i>AI1 scaled at AI1 min</i> | <p>(Visible when 14.01 Module 1 type = FIO-11 or FAIO-01)</p> <p>Defines the real value that corresponds to the minimum analog input AI1 value defined by parameter 14.33 AI1 min.</p>                                  | 0.000         |
| -32768.000 ... 32767.000 |                              | Real value corresponding to minimum AI1 value.   | 1 = 1         |
| 14.36                    | <i>RO1 OFF delay</i>         | <p>(Visible when 14.01 Module 1 type = FIO-01 or FDIO-01)</p> <p>Defines the deactivation delay for relay output RO1. See parameter 14.35 RO1 ON delay.</p>  | 0.00 s        |
| 0.00 ... 3000.00 s       |                              | Deactivation delay for RO1.  | 10 = 1 s      |
| 14.36                    | <i>AI1 scaled at AI1 max</i> | <p>(Visible when 14.01 Module 1 type = FIO-11 or FAIO-01)</p> <p>Defines the real value that corresponds to the maximum analog input AI1 value defined by parameter 14.34 AI1 max. See the drawing at parameter 14.35 AI1 scaled at AI1 min.</p>   | 100.000       |
| -32768.000 ... 32767.000 |                              | Real value corresponding to maximum AI1 value.   | 1 = 1         |
| 14.37                    | <i>RO2 source</i>            | <p>(Visible when 14.01 Module 1 type = FIO-01 or FDIO-01)</p> <p>Selects a drive signal to be connected to relay output RO2. For the available selections, see parameter 14.11 DIO1 output source.</p>   | Not energized |

| No.   | Name/Value                    | Description   | Def/FbEq16       |
|-------|-------------------------------|---|------------------|
| 14.38 | <i>RO2 ON delay</i>           | (Visible when 14.01 Module 1 type = FIO-01 or FDIO-01)<br>Defines the activation delay for relay output RO2. See parameter 14.35 RO1 ON delay.  | 0.00 s           |
|       | 0.00 ... 3000.00 s            | Activation delay for RO2.   | 10 = 1 s         |
| 14.39 | <i>RO2 OFF delay</i>          | (Visible when 14.01 Module 1 type = FIO-01 or FDIO-01)<br>Defines the deactivation delay for relay output RO2. See parameter 14.35 RO1 ON delay.  | 0.00 s           |
|       | 0.00 ... 3000.00 s            | Deactivation delay for RO2.   | 10 = 1 s         |
| 14.41 | <i>AI2 actual value</i>       | (Visible when 14.01 Module 1 type = FIO-11 or FAIO-01)<br>Displays the value of analog input AI2 in mA or V (depending on whether the input is set to current or voltage).<br>This parameter is read-only.  | -                |
|       | -22.000 ... 22.000 mA or V    | Value of analog input AI2.  | 1000 = 1 mA or V |
| 14.42 | <i>AI2 scaled value</i>       | (Visible when 14.01 Module 1 type = FIO-11 or FAIO-01)<br>Displays the value of analog input AI2 after scaling. See parameter 14.50 AI2 scaled at AI2 min.<br>This parameter is read-only.  | -                |
|       | -32768.000 ... 32767.000      | Scaled value of analog input AI2.   | 1 = 1            |
| 14.43 | <i>AI2 force data</i>         | (Visible when 14.01 Module 1 type = FIO-11 or FAIO-01)<br>Forced value that can be used instead of the true reading of the input. See parameter 14.22 AI force selection.   | 0.000 mA         |
|       | -22.000 ... 22.000 mA or V    | Forced value of analog input AI2.   | 1000 = 1 mA or V |
| 14.44 | <i>AI2 HW switch position</i> | (Visible when 14.01 Module 1 type = FIO-11 or FAIO-01)<br>Shows the position of the hardware current/voltage selector on the I/O extension module.<br><b>Note:</b> The setting of the current/voltage selector must match the unit selection made in parameter 14.45 AI2 unit selection. I/O module reboot either by cycling the power or through parameter 96.08 Control board boot is required to validate any changes in the hardware settings.  | -                |
|       | V                             | Volts.  | 2                |
|       | mA                            | Milliamperes.   | 10               |
| 14.45 | <i>AI2 unit selection</i>     | (Visible when 14.01 Module 1 type = FIO-11 or FAIO-01)<br>Selects the unit for readings and settings related to analog input AI2.<br><b>Note:</b> This setting must match the corresponding hardware setting on the I/O extension module (see the manual of the I/O extension module). The hardware setting is shown by parameter 14.44 AI2 HW switch position. I/O module reboot either by cycling the power or through parameter 96.08 Control board boot is required to validate any changes in the hardware settings. | mA               |
|       | V                             | Volts.  | 2                |
|       | mA                            | Milliamperes.   | 10               |
| 14.46 | <i>AI2 filter gain</i>        | (Visible when 14.01 Module 1 type = FIO-11 or FAIO-01)<br>Selects a hardware filtering time for AI2.<br>See also parameter 14.47 AI2 filter time.   | 1 ms             |
|       | No filtering                  | No filtering.   | 0                |

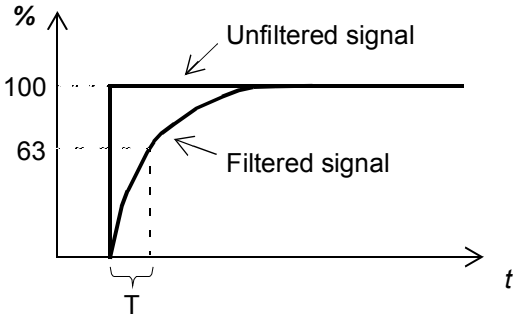
| No.   | Name/Value                 | Description   | Def/FbEq16       |
|-------|----------------------------|---|------------------|
|       | 125 us                     | 125 microseconds.   | 1                |
|       | 250 us                     | 250 microseconds.   | 2                |
|       | 500 us                     | 500 microseconds.   | 3                |
|       | 1 ms                       | 1 millisecond.  | 4                |
|       | 2 ms                       | 2 milliseconds.   | 5                |
|       | 4 ms                       | 4 milliseconds.   | 6                |
|       | 7.9375 ms                  | 7.9375 milliseconds.  | 7                |
| 14.47 | <i>AI2 filter time</i>     | <p>(Visible when 14.01 Module 1 type = FIO-11 or FAIO-01)<br/>                     Defines the filter time constant for analog input AI2.</p>  <p style="text-align: center;"><math>O = I \times (1 - e^{-t/T})</math></p> <p>                     I = filter input (step)<br/>                     O = filter output<br/>                     t = time<br/>                     T = filter time constant                 </p> <p><b>Note:</b> The signal is also filtered due to the signal interface hardware. See parameter 14.46 AI2 filter gain.</p> | 0.100 s          |
|       | 0.000 ... 30.000 s         | Filter time constant.   | 1000 = 1 s       |
| 14.48 | <i>AI2 min</i>             | <p>(Visible when 14.01 Module 1 type = FIO-11 or FAIO-01)<br/>                     Defines the minimum value for analog input AI2.<br/>                     See also parameter 14.21 AI tune.</p>   | 0.000 mA or V    |
|       | -22.000 ... 22.000 mA or V | Minimum value of AI2.   | 1000 = 1 mA or V |
| 14.49 | <i>AI2 max</i>             | <p>(Visible when 14.01 Module 1 type = FIO-11 or FAIO-01)<br/>                     Defines the maximum value for analog input AI2.<br/>                     See also parameter 14.21 AI tune.</p>   | 10.000 mA or V   |
|       | -22.000 ... 22.000 mA or V | Maximum value of AI2.   | 1000 = 1 mA or V |

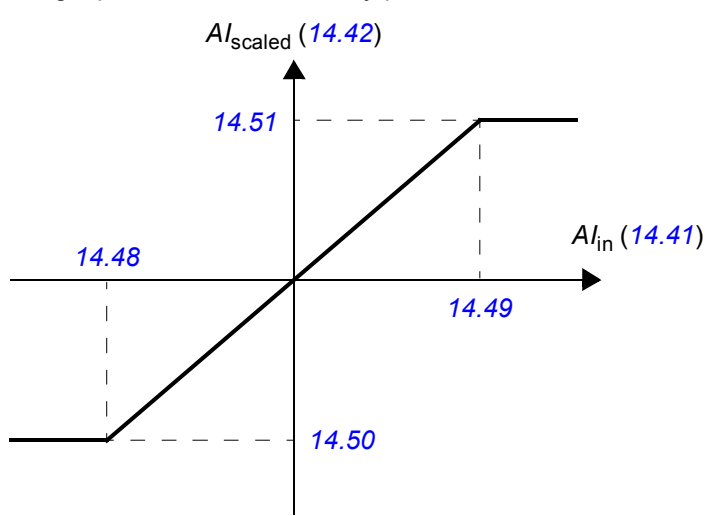

| No.   | Name/Value                    | Description  | Def/FbEq16          |
|-------|-------------------------------|--|---------------------|
| 14.50 | <i>AI2 scaled at AI2 min</i>  | <p>(Visible when 14.01 Module 1 type = FIO-11 or FAIO-01)</p> <p>Defines the real value that corresponds to the minimum analog input AI2 value defined by parameter 14.48 <i>AI2 min</i>.</p>    | 0.000               |
|       | -32768.000 ...<br>32767.000   | Real value corresponding to minimum AI2 value.   | 1 = 1               |
| 14.51 | <i>AI2 scaled at AI2 max</i>  | <p>(Visible when 14.01 Module 1 type = FIO-11 or FAIO-01)</p> <p>Defines the real value that corresponds to the maximum analog input AI2 value defined by parameter 14.49 <i>AI2 max</i>. See the drawing at parameter 14.50 <i>AI2 scaled at AI2 min</i>.</p>   | 100.000             |
|       | -32768.000 ...<br>32767.000   | Real value corresponding to maximum AI2 value.   | 1 = 1               |
| 14.56 | <i>AI3 actual value</i>       | <p>(Visible when 14.01 Module 1 type = FIO-11)</p> <p>Displays the value of analog input AI3 in mA or V (depending on whether the input is set to current or voltage). This parameter is read-only.</p>  | -                   |
|       | -22.000 ... 22.000<br>mA or V | Value of analog input AI3.   | 1000 = 1 mA<br>or V |
| 14.57 | <i>AI3 scaled value</i>       | <p>(Visible when 14.01 Module 1 type = FIO-11)</p> <p>Displays the value of analog input AI3 after scaling. See parameter 14.65 <i>AI3 scaled at AI3 min</i>. This parameter is read-only.</p>   | -                   |
|       | -32768.000 ...<br>32767.000   | Scaled value of analog input AI3.  | 1 = 1               |
| 14.58 | <i>AI3 force data</i>         | <p>(Visible when 14.01 Module 1 type = FIO-11)</p> <p>Forced value that can be used instead of the true reading of the input. See parameter 14.22 <i>AI force selection</i>.</p>   | 0.000 mA            |
|       | -22.000 ... 22.000<br>mA or V | Forced value of analog input AI3.  | 1000 = 1 mA<br>or V |
| 14.59 | <i>AI3 HW switch position</i> | <p>(Visible when 14.01 Module 1 type = FIO-11)</p> <p>Shows the position of the hardware current/voltage selector on the I/O extension module.</p> <p><b>Note:</b> The setting of the current/voltage selector must match the unit selection made in parameter 14.60 <i>AI3 unit selection</i>. I/O module reboot either by cycling the power or through parameter 96.08 <i>Control board boot</i> is required to validate any changes in the hardware settings.</p> | -                   |
|       | V                             | Volts.   | 2                   |

| No.   | Name/Value                | Description  | Def/FbEq16 |
|-------|---------------------------|--|------------|
|       | mA                        | Milliamperes.  | 10         |
| 14.60 | <i>AI3 unit selection</i> | <p>(Visible when 14.01 Module 1 type = FIO-11)</p> <p>Selects the unit for readings and settings related to analog input AI3.</p> <p><b>Note:</b> This setting must match the corresponding hardware setting on the I/O extension module (see the manual of the I/O extension module). The hardware setting is shown by parameter 14.59 AI3 HW switch position. I/O module reboot either by cycling the power or through parameter 96.08 Control board boot is required to validate any changes in the hardware settings.</p>                              | mA         |
|       | V                         | Volts.   | 2          |
|       | mA                        | Milliamperes.  | 10         |
| 14.61 | <i>AI3 filter gain</i>    | <p>(Visible when 14.01 Module 1 type = FIO-11)</p> <p>Selects a hardware filtering time for AI3.</p> <p>See also parameter 14.62 AI3 filter time.</p>  | 1 ms       |
|       | No filtering              | No filtering.  | 0          |
|       | 125 us                    | 125 microseconds.  | 1          |
|       | 250 us                    | 250 microseconds.  | 2          |
|       | 500 us                    | 500 microseconds.  | 3          |
|       | 1 ms                      | 1 millisecond.   | 4          |
|       | 2 ms                      | 2 milliseconds.  | 5          |
|       | 4 ms                      | 4 milliseconds.  | 6          |
|       | 7.9375 ms                 | 7.9375 milliseconds.   | 7          |
| 14.62 | <i>AI3 filter time</i>    | <p>(Visible when 14.01 Module 1 type = FIO-11)</p> <p>Defines the filter time constant for analog input AI3.</p> <div style="text-align: center;"> </div> <p> <math display="block">O = I \times (1 - e^{-t/T})</math> </p> <p>                     I = filter input (step)<br/>                     O = filter output<br/>                     t = time<br/>                     T = filter time constant                 </p> <p><b>Note:</b> The signal is also filtered due to the signal interface hardware. See parameter 14.61 AI3 filter gain.</p> | 0.100 s    |
|       | 0.000 ... 30.000 s        | Filter time constant.  | 1000 = 1 s |

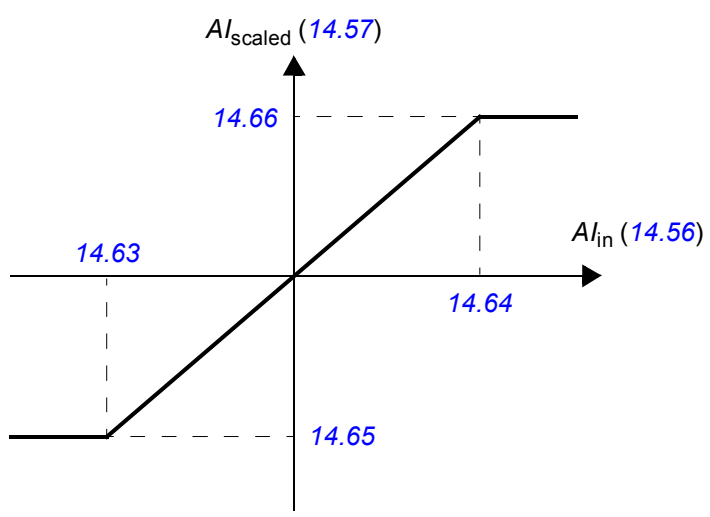
| No.    | Name/Value                   | Description   | Def/FbEq16       |      |             |   |     |   |   |     |  |        |          |  |  |
|--------|------------------------------|---|------------------|------|-------------|---|-----|---|---|-----|--|--------|----------|--|--|
| 14.63  | <i>AI3 min</i>               | (Visible when 14.01 Module 1 type = FIO-11)<br>Defines the minimum value for analog input AI3.<br>See also parameter 14.21 AI tune.   | 0.000 mA or V    |      |             |   |     |   |   |     |  |        |          |  |  |
|        | -22.000 ... 22.000 mA or V   | Minimum value of AI3.   | 1000 = 1 mA or V |      |             |   |     |   |   |     |  |        |          |  |  |
| 14.64  | <i>AI3 max</i>               | (Visible when 14.01 Module 1 type = FIO-11)<br>Defines the maximum value for analog input AI3.<br>See also parameter 14.21 AI tune.   | 10.000 mA or V   |      |             |   |     |   |   |     |  |        |          |  |  |
|        | -22.000 ... 22.000 mA or V   | Maximum value of AI3.   | 1000 = 1 mA or V |      |             |   |     |   |   |     |  |        |          |  |  |
| 14.65  | <i>AI3 scaled at AI3 min</i> | (Visible when 14.01 Module 1 type = FIO-11)<br>Defines the real value that corresponds to the minimum analog input AI3 value defined by parameter 14.63 AI3 min.<br><br>   | 0.000            |      |             |   |     |   |   |     |  |        |          |  |  |
|        | -32768.000 ... 32767.000     | Real value corresponding to minimum AI3 value.  | 1 = 1            |      |             |   |     |   |   |     |  |        |          |  |  |
| 14.66  | <i>AI3 scaled at AI3 max</i> | (Visible when 14.01 Module 1 type = FIO-11)<br>Defines the real value that corresponds to the maximum analog input AI3 value defined by parameter 14.64 AI3 max.<br>See the drawing at parameter 14.65 AI3 scaled at AI3 min.   | 100.000          |      |             |   |     |   |   |     |  |        |          |  |  |
|        | -32768.000 ... 32767.000     | Real value corresponding to maximum AI3 value.  | 1 = 1            |      |             |   |     |   |   |     |  |        |          |  |  |
| 14.71  | <i>AO force selection</i>    | (Visible when 14.01 Module 1 type = FIO-11 or FAIO-01)<br>The value of the analog output can be overridden for eg. testing purposes. A forced value parameter (14.78 AO1 force data) is provided for the analog output, and its value is applied whenever the corresponding bit in this parameter is 1.   | 00b              |      |             |   |     |   |   |     |  |        |          |  |  |
|        |                              | <table border="1" data-bbox="294 1776 1433 1957"> <thead> <tr> <th>Bit</th> <th>Name</th> <th>Description</th> </tr> </thead> <tbody> <tr> <td>0</td> <td>AO1</td> <td>1 = Force mode: Force AO1 to value of parameter 14.78 AO1 force data.</td> </tr> <tr> <td>1</td> <td>AO2</td> <td>1 = Force mode: Force AO2 to value of parameter 14.88 AO2 force data (FAIO-01 only).</td> </tr> <tr> <td>3...15</td> <td>Reserved</td> <td></td> </tr> </tbody> </table> | Bit              | Name | Description | 0 | AO1 | 1 = Force mode: Force AO1 to value of parameter 14.78 AO1 force data. | 1 | AO2 | 1 = Force mode: Force AO2 to value of parameter 14.88 AO2 force data (FAIO-01 only). | 3...15 | Reserved |  |  |
| Bit    | Name                         | Description   |                  |      |             |   |     |   |   |     |  |        |          |  |  |
| 0      | AO1                          | 1 = Force mode: Force AO1 to value of parameter 14.78 AO1 force data.   |                  |      |             |   |     |   |   |     |  |        |          |  |  |
| 1      | AO2                          | 1 = Force mode: Force AO2 to value of parameter 14.88 AO2 force data (FAIO-01 only).  |                  |      |             |   |     |   |   |     |  |        |          |  |  |
| 3...15 | Reserved                     |   |                  |      |             |   |     |   |   |     |  |        |          |  |  |
|        | 00b...11b                    | Forced values selector for analog outputs.  | 1 = 1            |      |             |   |     |   |   |     |  |        |          |  |  |

## 180 Parameters

| No.   | Name/Value              | Description   | Def/FbEq16  |
|-------|-------------------------|---|-------------|
| 14.76 | AO1 actual value        | (Visible when 14.01 Module 1 type = FIO-11 or FAIO-01)<br>Displays the value of AO1 in mA.<br>This parameter is read-only.  | -           |
|       | 0.000 ... 22.000 mA     | Value of AO1.   | 1000 = 1 mA |
| 14.77 | AO1 source              | (Visible when 14.01 Module 1 type = FIO-11 or FAIO-01)<br>Selects a signal to be connected to analog output AO1.<br>Alternatively, sets the output to excitation mode to feed a constant current to a temperature sensor. | Zero        |
|       | Zero                    | None.   | 0           |
|       | Motor speed used        | <a href="#">01.01 Motor speed used</a> (page 115).  | 1           |
|       | Output frequency        | <a href="#">01.06 Output frequency</a> (page 115).  | 3           |
|       | Motor current           | <a href="#">01.07 Motor current</a> (page 115).   | 4           |
|       | Motor torque            | <a href="#">01.10 Motor torque</a> (page 115).  | 6           |
|       | DC voltage              | <a href="#">01.11 DC voltage</a> (page 115).  | 7           |
|       | Power inu out           | <a href="#">01.14 Output power</a> (page 116).  | 8           |
|       | Speed ref ramp in       | <a href="#">23.01 Speed ref ramp input</a> (page 218).  | 10          |
|       | Speed ref ramp out      | <a href="#">23.02 Speed ref ramp output</a> (page 218).   | 11          |
|       | Speed ref used          | <a href="#">24.01 Used speed reference</a> (page 224).  | 12          |
|       | Torq ref used           | <a href="#">26.02 Torque reference used</a> (page 240).   | 13          |
|       | Freq ref used           | <a href="#">28.02 Frequency ref ramp output</a> (page 246).   | 14          |
|       | Process PID out         | <a href="#">40.01 Process PID output actual</a> (page 301).   | 16          |
|       | Process PID fbk         | <a href="#">40.02 Process PID feedback actual</a> (page 301).   | 17          |
|       | Process PID act         | <a href="#">40.03 Process PID setpoint actual</a> (page 301).   | 18          |
|       | Process PID dev         | <a href="#">40.04 Process PID deviation actual</a> (page 301).  | 19          |
|       | Force Pt100 excitation  | The output is used to feed an excitation current to 1...3 Pt100 sensors. See section <a href="#">Motor thermal protection</a> (page 80).  | 20          |
|       | Force KTY84 excitation  | The output is used to feed an excitation current to a KTY84 sensor. See section <a href="#">Motor thermal protection</a> (page 80).   | 21          |
|       | Force PTC excitation    | The output is used to feed an excitation current to 1...3 PTC sensors. See section <a href="#">Motor thermal protection</a> (page 80).  | 22          |
|       | Force Pt1000 excitation | The output is used to feed an excitation current to 1...3 Pt1000 sensors. See section <a href="#">Motor thermal protection</a> (page 80).   | 23          |
|       | AO1 data storage        | <a href="#">13.91 AO1 data storage</a> (page 165).  | 37          |
|       | AO2 data storage        | <a href="#">13.92 AO2 data storage</a> (page 165).  | 38          |
|       | Other                   | Source selection (see <a href="#">Terms and abbreviations</a> on page 112).   | -           |
| 14.78 | AO1 force data          | (Visible when 14.01 Module 1 type = FIO-11 or FAIO-01)<br>Forced value that can be used instead of the selected output signal. See parameter <a href="#">14.71 AO force selection</a> .                                   | 0.000 mA    |
|       | 0.000 ... 22.000 mA     | Forced value of analog output AO1.  | 1000 = 1 mA |

| No.                | Name/Value            | Description   | Def/FbEq16 |
|--------------------|-----------------------|---|------------|
| 14.79              | AO1 filter time       | <p>(Visible when 14.01 Module 1 type = FIO-11 or FAIO-01)</p> <p>Defines the filtering time constant for analog output AO1.</p> <div data-bbox="597 331 1110 645" data-label="Figure"> </div> $O = I \times (1 - e^{-t/T})$ <p>           I = filter input (step)<br/>           O = filter output<br/>           t = time<br/>           T = filter time constant         </p> | 0.100 s    |
| 0.000 ... 30.000 s | Filter time constant. | 1000 = 1 s  |            |

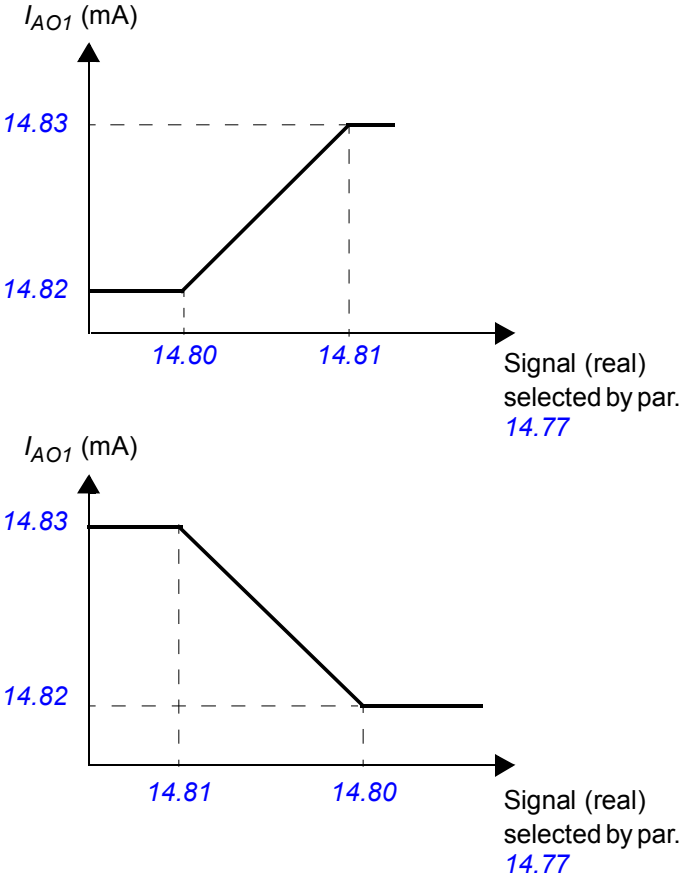
| No.   | Name/Value                    | Description  | Def/FbEq16  |
|-------|-------------------------------|--|-------------|
| 14.80 | <i>AO1 source min</i>         | <p>(Visible when 14.01 Module 1 type = FIO-11 or FAIO-01)</p> <p>Defines the real value of the signal (selected by parameter 14.77 AO1 source) that corresponds to the minimum AO1 output value (defined by parameter 14.82 AO1 out at AO1 src min).</p>  <p>The figure contains two graphs. The top graph plots <math>I_{AO1}</math> (mA) on the y-axis against 'Signal (real) selected by par. 14.77' on the x-axis. The y-axis has values 14.82 and 14.83. The x-axis has values 14.80 and 14.81. The curve is constant at 14.82 mA for signal values up to 14.80, then rises linearly to 14.83 mA at signal value 14.81, and remains constant thereafter. The bottom graph plots <math>I_{AO1}</math> (mA) on the y-axis against 'Signal (real) selected by par. 14.77' on the x-axis. The y-axis has values 14.82 and 14.83. The x-axis has values 14.81 and 14.80. The curve is constant at 14.83 mA for signal values up to 14.81, then falls linearly to 14.82 mA at signal value 14.80, and remains constant thereafter.</p> | 0.0         |
|       | -32768.0 ...<br>32767.0       | Real signal value corresponding to minimum AO1 output value.   | 1 = 1       |
| 14.81 | <i>AO1 source max</i>         | <p>(Visible when 14.01 Module 1 type = FIO-11 or FAIO-01)</p> <p>Defines the real value of the signal (selected by parameter 14.77 AO1 source) that corresponds to the maximum AO1 output value (defined by parameter 14.83 AO1 out at AO1 src max). See parameter 14.80 AO1 source min.</p>   | 100.0       |
|       | -32768.0 ...<br>32767.0       | Real signal value corresponding to maximum AO1 output value.   | 1 = 1       |
| 14.82 | <i>AO1 out at AO1 src min</i> | <p>(Visible when 14.01 Module 1 type = FIO-11 or FAIO-01)</p> <p>Defines the minimum output value for analog output AO1. See also drawing at parameter 14.80 AO1 source min.</p>   | 0.000 mA    |
|       | 0.000 ... 22.000 mA           | Minimum AO1 output value.  | 1000 = 1 mA |
| 14.83 | <i>AO1 out at AO1 src max</i> | <p>(Visible when 14.01 Module 1 type = FIO-11 or FAIO-01)</p> <p>Defines the maximum output value for analog output AO1. See also drawing at parameter 14.80 AO1 source min.</p>   | 10.000 mA   |
|       | 0.000 ... 22.000 mA           | Maximum AO1 output value.  | 1000 = 1 mA |

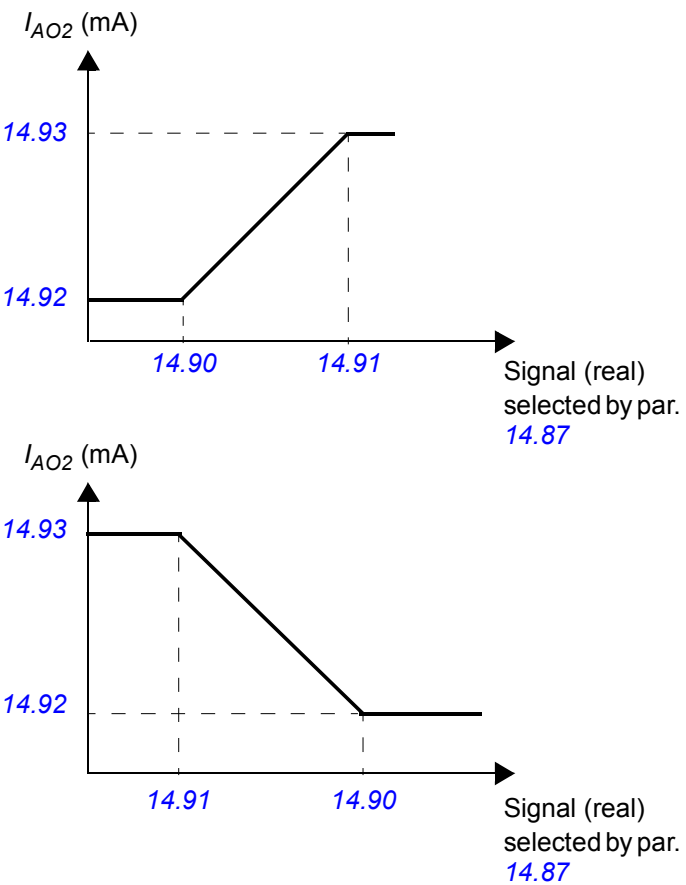
| No.   | Name/Value           | Description   | Def/FbEq16  |
|-------|----------------------|---|-------------|
| 14.86 | AO2 actual value     | (Visible when 14.01 Module 1 type = FAIO-01)<br>Displays the value of AO2 in mA.<br>This parameter is read-only.  | -           |
|       | 0.000 ... 22.000 mA  | Value of AO2.   | 1000 = 1 mA |
| 14.87 | AO2 source           | (Visible when 14.01 Module 1 type = FAIO-01)<br>Selects a signal to be connected to analog output AO2.<br>Alternatively, sets the output to excitation mode to feed a constant current to a temperature sensor.<br>For the selections, see parameter 14.77 AO1 source.  | Zero        |
| 14.88 | AO2 force data       | (Visible when 14.01 Module 1 type = FAIO-01)<br>Forced value that can be used instead of the selected output signal. See parameter 14.71 AO force selection.  | 0.000 mA    |
|       | 0.000 ... 22.000 mA  | Forced value of analog output AO2.  | 1000 = 1 mA |
| 14.89 | AO2 filter time      | (Visible when 14.01 Module 1 type = FAIO-01)<br>Defines the filtering time constant for analog output AO2. See parameter 14.79 AO1 filter time.   | 0.100 s     |
|       | 0.000 ... 30.000 s   | Filter time constant.   | 1000 = 1 s  |
| 14.90 | AO2 source min       | (Visible when 14.01 Module 1 type = FAIO-01)<br>Defines the real value of the signal (selected by parameter 14.87 AO2 source) that corresponds to the minimum AO2 output value (defined by parameter 14.92 AO2 out at AO2 src min).<br><br> | 0.0         |
|       | -32768.0 ... 32767.0 | Real signal value corresponding to minimum AO2 output value.  | 1 = 1       |

## 184 Parameters

| No.                              | Name/Value              | Description   | Def/FbEq16    |
|----------------------------------|-------------------------|---|---------------|
| 14.91                            | AO2 source max          | (Visible when 14.01 Module 1 type = FAIO-01)<br>Defines the real value of the signal (selected by parameter 14.87 AO2 source) that corresponds to the maximum AO2 output value (defined by parameter 14.93 AO2 out at AO2 src max). See parameter 14.90 AO2 source min. | 100.0         |
|                                  | -32768.0 ...<br>32767.0 | Real signal value corresponding to maximum AO2 output value.  | 1 = 1         |
| 14.92                            | AO2 out at AO2 src min  | (Visible when 14.01 Module 1 type = FAIO-01)<br>Defines the minimum output value for analog output AO2. See also drawing at parameter 14.90 AO2 source min.   | 0.000 mA      |
|                                  | 0.000 ... 22.000 mA     | Minimum AO2 output value.   | 1000 = 1 mA   |
| 14.93                            | AO2 out at AO2 src max  | (Visible when 14.01 Module 1 type = FAIO-01)<br>Defines the maximum output value for analog output AO2. See also drawing at parameter 14.90 AO2 source min.   | 10.000 mA     |
|                                  | 0.000 ... 22.000 mA     | Maximum AO2 output value.   | 1000 = 1 mA   |
| <b>15 I/O extension module 2</b> |                         | Configuration of I/O extension module 2.<br>See also section <i>Programmable I/O extensions</i> (page 29).<br><b>Note:</b> The contents of the parameter group vary according to the selected I/O extension module type.  |               |
| 15.01                            | Module 2 type           | See parameter 14.01 Module 1 type.  | None          |
| 15.02                            | Module 2 location       | See parameter 14.02 Module 1 location.  | Slot 1        |
| 15.03                            | Module 2 status         | See parameter 14.03 Module 1 status.  | No option     |
| 15.05                            | DI status               | (Visible when 15.01 Module 2 type = FDIO-01)<br>See parameter 14.05 DI status.  | -             |
| 15.05                            | DIO status              | (Visible when 15.01 Module 2 type = FIO-01 or FIO-11)<br>See parameter 14.05 DIO status.  | -             |
| 15.06                            | DI delayed status       | (Visible when 15.01 Module 2 type = FDIO-01)<br>See parameter 14.06 DI delayed status.  | -             |
| 15.06                            | DIO delayed status      | (Visible when 15.01 Module 2 type = FIO-01 or FIO-11)<br>See parameter 14.06 DIO delayed status.  | -             |
| 15.08                            | DI filter time          | (Visible when 15.01 Module 2 type = FDIO-01)<br>See parameter 14.08 DI filter time.   | 10.0 ms       |
| 15.08                            | DIO filter time         | (Visible when 15.01 Module 2 type = FIO-01 or FIO-11)<br>See parameter 14.08 DIO filter time.   | 10.0 ms       |
| 15.09                            | DIO1 function           | (Visible when 15.01 Module 2 type = FIO-01 or FIO-11)<br>See parameter 14.09 DIO1 function.   | Input         |
| 15.11                            | DIO1 output source      | (Visible when 15.01 Module 2 type = FIO-01 or FIO-11)<br>See parameter 14.11 DIO1 output source.  | Not energized |
| 15.12                            | DI1 ON delay            | (Visible when 15.01 Module 2 type = FDIO-01)<br>See parameter 14.12 DI1 ON delay.   | 0.00 s        |
| 15.12                            | DIO1 ON delay           | (Visible when 15.01 Module 2 type = FIO-01 or FIO-11)<br>See parameter 14.12 DIO1 ON delay.   | 0.00 s        |
| 15.13                            | DI1 OFF delay           | (Visible when 15.01 Module 2 type = FDIO-01)<br>See parameter 14.13 DI1 OFF delay.  | 0.00 s        |
| 15.13                            | DIO1 OFF delay          | (Visible when 15.01 Module 2 type = FIO-01 or FIO-11)<br>See parameter 14.13 DIO1 OFF delay.  | 0.00 s        |



| No.   | Name/Value               | Description   | Def/FbEq16    |
|-------|--------------------------|---|---------------|
| 15.14 | DIO2 function            | (Visible when 15.01 Module 2 type = FIO-01 or FIO-11)<br>See parameter 14.14 DIO2 function.             | Input         |
| 15.16 | DIO2 output source       | (Visible when 15.01 Module 2 type = FIO-01 or FIO-11)<br>See parameter 14.16 DIO2 output source.        | Not energized |
| 15.17 | DI2 ON delay             | (Visible when 15.01 Module 2 type = FDIO-01)<br>See parameter 14.17 DI2 ON delay.                       | 0.00 s        |
| 15.17 | DIO2 ON delay            | (Visible when 15.01 Module 2 type = FIO-01 or FIO-11)<br>See parameter 14.17 DIO2 ON delay.             | 0.00 s        |
| 15.18 | DI2 OFF delay            | (Visible when 15.01 Module 2 type = FDIO-01)<br>See parameter 14.18 DI2 OFF delay.                      | 0.00 s        |
| 15.18 | DIO2 OFF delay           | (Visible when 15.01 Module 2 type = FIO-01 or FIO-11)<br>See parameter 14.18 DIO2 OFF delay.            | 0.00 s        |
| 15.19 | DIO3 function            | (Visible when 15.01 Module 2 type = FIO-01)<br>See parameter 14.19 DIO3 function.                       | Input         |
| 15.19 | AI supervision function  | (Visible when 15.01 Module 2 type = FIO-11 or FAIO-01)<br>See parameter 14.19 AI supervision function.  | No action     |
| 15.20 | AI supervision selection | (Visible when 15.01 Module 2 type = FIO-11 or FAIO-01)<br>See parameter 14.20 AI supervision selection. | 0000 0000b    |
| 15.21 | DIO3 output source       | (Visible when 15.01 Module 2 type = FIO-01)<br>See parameter 14.21 DIO3 output source.                  | Not energized |
| 15.21 | AI tune                  | (Visible when 15.01 Module 2 type = FIO-11 or FAIO-01)<br>See parameter 14.21 AI tune.                  | No action     |
| 15.22 | DI3 ON delay             | (Visible when 15.01 Module 2 type = FDIO-01)<br>See parameter 14.22 DI3 ON delay.                       | 0.00 s        |
| 15.22 | DIO3 ON delay            | (Visible when 15.01 Module 2 type = FIO-01)<br>See parameter 14.22 DIO3 ON delay.                       | 0.00 s        |
| 15.22 | AI force selection       | (Visible when 15.01 Module 2 type = FIO-11 or FAIO-01)<br>See parameter 14.22 AI force selection.       | 0000b         |
| 15.23 | DI3 OFF delay            | (Visible when 15.01 Module 2 type = FDIO-01)<br>See parameter 14.23 DI3 OFF delay.                      | 0.00 s        |
| 15.23 | DIO3 OFF delay           | (Visible when 15.01 Module 2 type = FIO-01)<br>See parameter 14.23 DIO3 OFF delay.                      | 0.00 s        |
| 15.24 | DIO4 function            | (Visible when 15.01 Module 2 type = FIO-01)<br>See parameter 14.24 DIO4 function.                       | Input         |
| 15.26 | DIO4 output source       | (Visible when 15.01 Module 2 type = FIO-01)<br>See parameter 14.26 DIO4 output source.                  | Not energized |
| 15.26 | AI1 actual value         | (Visible when 15.01 Module 2 type = FIO-11 or FAIO-01)<br>See parameter 14.26 AI1 actual value.         | -             |
| 15.27 | DIO4 ON delay            | (Visible when 15.01 Module 2 type = FIO-01)<br>See parameter 14.27 DIO4 ON delay.                       | 0.00 s        |
| 15.27 | AI1 scaled value         | (Visible when 15.01 Module 2 type = FIO-11 or FAIO-01)<br>See parameter 14.27 AI1 scaled value.         | -             |
| 15.28 | DIO4 OFF delay           | (Visible when 15.01 Module 2 type = FIO-01)<br>See parameter 14.28 DIO4 OFF delay.                      | 0.00 s        |
| 15.28 | AI1 force data           | (Visible when 15.01 Module 2 type = FIO-11 or FAIO-01)<br>See parameter 14.28 AI1 force data.           | 0.000 mA      |

| No.   | Name/Value             | Description   | Def/FbEq16     |
|-------|------------------------|---|----------------|
| 15.29 | AI1 HW switch position | (Visible when 15.01 Module 2 type = FIO-11 or FAIO-01)<br>See parameter 14.29 AI1 HW switch position. | -              |
| 15.30 | AI1 unit selection     | (Visible when 15.01 Module 2 type = FIO-11 or FAIO-01)<br>See parameter 14.30 AI1 unit selection.     | mA             |
| 15.31 | RO status              | (Visible when 15.01 Module 2 type = FIO-01 or FDIO-01)<br>See parameter 14.31 RO status.              | -              |
| 15.31 | AI1 filter gain        | (Visible when 15.01 Module 2 type = FIO-11 or FAIO-01)<br>See parameter 14.31 AI1 filter gain.        | 1 ms           |
| 15.32 | AI1 filter time        | (Visible when 15.01 Module 2 type = FIO-11 or FAIO-01)<br>See parameter 14.32 AI1 filter time.        | 0.100 s        |
| 15.33 | AI1 min                | (Visible when 15.01 Module 2 type = FIO-11 or FAIO-01)<br>See parameter 14.33 AI1 min.                | 0.000 mA or V  |
| 15.34 | RO1 source             | (Visible when 15.01 Module 2 type = FIO-01 or FDIO-01)<br>See parameter 14.34 RO1 source.             | Not energized  |
| 15.34 | AI1 max                | (Visible when 15.01 Module 2 type = FIO-11 or FAIO-01)<br>See parameter 14.34 AI1 max.                | 10.000 mA or V |
| 15.35 | RO1 ON delay           | (Visible when 15.01 Module 2 type = FIO-01 or FDIO-01)<br>See parameter 14.35 RO1 ON delay.           | 0.00 s         |
| 15.35 | AI1 scaled at AI1 min  | (Visible when 15.01 Module 2 type = FIO-11 or FAIO-01)<br>See parameter 14.35 AI1 scaled at AI1 min.  | 0.000          |
| 15.36 | RO1 OFF delay          | (Visible when 15.01 Module 2 type = FIO-01 or FDIO-01)<br>See parameter 14.36 RO1 OFF delay.          | 0.00 s         |
| 15.36 | AI1 scaled at AI1 max  | (Visible when 15.01 Module 2 type = FIO-11 or FAIO-01)<br>See parameter 14.36 AI1 scaled at AI1 max.  | 100.000        |
| 15.37 | RO2 source             | (Visible when 15.01 Module 2 type = FIO-01 or FDIO-01)<br>See parameter 14.37 RO2 source.             | Not energized  |
| 15.38 | RO2 ON delay           | (Visible when 15.01 Module 2 type = FIO-01 or FDIO-01)<br>See parameter 14.38 RO2 ON delay.           | 0.00 s         |
| 15.39 | RO2 OFF delay          | (Visible when 15.01 Module 2 type = FIO-01 or FDIO-01)<br>See parameter 14.39 RO2 OFF delay.          | 0.00 s         |
| 15.41 | AI2 actual value       | (Visible when 15.01 Module 2 type = FIO-11 or FAIO-01)<br>See parameter 14.41 AI2 actual value.       | -              |
| 15.42 | AI2 scaled value       | (Visible when 15.01 Module 2 type = FIO-11 or FAIO-01)<br>See parameter 14.42 AI2 scaled value.       | -              |
| 15.43 | AI2 force data         | (Visible when 15.01 Module 2 type = FIO-11 or FAIO-01)<br>See parameter 14.43 AI2 force data.         | 0.000 mA       |
| 15.44 | AI2 HW switch position | (Visible when 15.01 Module 2 type = FIO-11 or FAIO-01)<br>See parameter 14.44 AI2 HW switch position. | -              |
| 15.45 | AI2 unit selection     | (Visible when 15.01 Module 2 type = FIO-11 or FAIO-01)<br>See parameter 14.45 AI2 unit selection.     | mA             |
| 15.46 | AI2 filter gain        | (Visible when 15.01 Module 2 type = FIO-11 or FAIO-01)<br>See parameter 14.46 AI2 filter gain.        | 1 ms           |
| 15.47 | AI2 filter time        | (Visible when 15.01 Module 2 type = FIO-11 or FAIO-01)<br>See parameter 14.47 AI2 filter time.        | 0.100 s        |
| 15.48 | AI2 min                | (Visible when 15.01 Module 2 type = FIO-11 or FAIO-01)<br>See parameter 14.48 AI2 min.                | 0.000 mA or V  |

| No.   | Name/Value                    | Description   | Def/FbEq16     |
|-------|-------------------------------|---|----------------|
| 15.49 | <i>AI2 max</i>                | (Visible when 15.01 Module 2 type = FIO-11 or FAIO-01)<br>See parameter 14.49 AI2 max.                | 10.000 mA or V |
| 15.50 | <i>AI2 scaled at AI2 min</i>  | (Visible when 15.01 Module 2 type = FIO-11 or FAIO-01)<br>See parameter 14.50 AI2 scaled at AI2 min.  | 0.000          |
| 15.51 | <i>AI2 scaled at AI2 max</i>  | (Visible when 15.01 Module 2 type = FIO-11 or FAIO-01)<br>See parameter 14.51 AI2 scaled at AI2 max.  | 100.000        |
| 15.56 | <i>AI3 actual value</i>       | (Visible when 15.01 Module 2 type = FIO-11)<br>See parameter 14.56 AI3 actual value.                  | -              |
| 15.57 | <i>AI3 scaled value</i>       | (Visible when 15.01 Module 2 type = FIO-11)<br>See parameter 14.57 AI3 scaled value.                  | -              |
| 15.58 | <i>AI3 force data</i>         | (Visible when 15.01 Module 2 type = FIO-11)<br>See parameter 14.58 AI3 force data.                    | 0.000 mA       |
| 15.59 | <i>AI3 HW switch position</i> | (Visible when 15.01 Module 2 type = FIO-11)<br>See parameter 14.59 AI3 HW switch position.            | -              |
| 15.60 | <i>AI3 unit selection</i>     | (Visible when 15.01 Module 2 type = FIO-11)<br>See parameter 14.60 AI3 unit selection.                | mA             |
| 15.61 | <i>AI3 filter gain</i>        | (Visible when 15.01 Module 2 type = FIO-11)<br>See parameter 14.61 AI3 filter gain.                   | 1 ms           |
| 15.62 | <i>AI3 filter time</i>        | (Visible when 15.01 Module 2 type = FIO-11)<br>See parameter 14.62 AI3 filter time.                   | 0.100 s        |
| 15.63 | <i>AI3 min</i>                | (Visible when 15.01 Module 2 type = FIO-11)<br>See parameter 14.63 AI3 min.                           | 0.000 mA or V  |
| 15.64 | <i>AI3 max</i>                | (Visible when 15.01 Module 2 type = FIO-11)<br>See parameter 14.64 AI3 max.                           | 10.000 mA or V |
| 15.65 | <i>AI3 scaled at AI3 min</i>  | (Visible when 15.01 Module 2 type = FIO-11)<br>See parameter 14.65 AI3 scaled at AI3 min.             | 0.000          |
| 15.66 | <i>AI3 scaled at AI3 max</i>  | (Visible when 15.01 Module 2 type = FIO-11)<br>See parameter 14.66 AI3 scaled at AI3 max.             | 100.000        |
| 15.71 | <i>AO force selection</i>     | (Visible when 15.01 Module 2 type = FIO-11 or FAIO-01)<br>See parameter 14.71 AO force selection.     | 00b            |
| 15.76 | <i>AO1 actual value</i>       | (Visible when 15.01 Module 2 type = FIO-11 or FAIO-01)<br>See parameter 14.76 AO1 actual value.       | -              |
| 15.77 | <i>AO1 source</i>             | (Visible when 15.01 Module 2 type = FIO-11 or FAIO-01)<br>See parameter 14.77 AO1 source.             | Zero           |
| 15.78 | <i>AO1 force data</i>         | (Visible when 15.01 Module 2 type = FIO-11 or FAIO-01)<br>See parameter 14.78 AO1 force data.         | 0.000 mA       |
| 15.79 | <i>AO1 filter time</i>        | (Visible when 15.01 Module 2 type = FIO-11 or FAIO-01)<br>See parameter 14.79 AO1 filter time.        | 0.100 s        |
| 15.80 | <i>AO1 source min</i>         | (Visible when 15.01 Module 2 type = FIO-11 or FAIO-01)<br>See parameter 14.80 AO1 source min.         | 0.0            |
| 15.81 | <i>AO1 source max</i>         | (Visible when 15.01 Module 2 type = FIO-11 or FAIO-01)<br>See parameter 14.81 AO1 source max.         | 100.0          |
| 15.82 | <i>AO1 out at AO1 src min</i> | (Visible when 15.01 Module 2 type = FIO-11 or FAIO-01)<br>See parameter 14.82 AO1 out at AO1 src min. | 0.000 mA       |
| 15.83 | <i>AO1 out at AO1 src max</i> | (Visible when 15.01 Module 2 type = FIO-11 or FAIO-01)<br>See parameter 14.83 AO1 out at AO1 src max. | 10.000 mA      |

| No.                              | Name/Value             | Description  | Def/FbEq16    |
|----------------------------------|------------------------|--|---------------|
| 15.86                            | AO2 actual value       | (Visible when 15.01 Module 2 type = FAIO-01)<br>See parameter 14.86 AO2 actual value.  | -             |
| 15.87                            | AO2 source             | (Visible when 15.01 Module 2 type = FAIO-01)<br>See parameter 14.87 AO2 source.  | Zero          |
| 15.88                            | AO2 force data         | (Visible when 15.01 Module 2 type = FAIO-01)<br>See parameter 14.88 AO2 force data.  | 0.000 mA      |
| 15.89                            | AO2 filter time        | (Visible when 15.01 Module 2 type = FAIO-01)<br>See parameter 14.89 AO2 filter time.   | 0.100 s       |
| 15.90                            | AO2 source min         | (Visible when 15.01 Module 2 type = FAIO-01)<br>See parameter 14.90 AO2 source min.  | 0.0           |
| 15.91                            | AO2 source max         | (Visible when 15.01 Module 2 type = FAIO-01)<br>See parameter 14.91 AO2 source max.  | 100.0         |
| 15.92                            | AO2 out at AO2 src min | (Visible when 15.01 Module 2 type = FAIO-01)<br>See parameter 14.92 AO2 out at AO2 src min.  | 0.000 mA      |
| 15.93                            | AO2 out at AO2 src max | (Visible when 15.01 Module 2 type = FAIO-01)<br>See parameter 14.93 AO2 out at AO2 src max.  | 10.000 mA     |
| <b>16 I/O extension module 3</b> |                        | Configuration of I/O extension module 3.<br>See also section <i>Programmable I/O extensions</i> (page 29).<br><b>Note:</b> The contents of the parameter group vary according to the selected I/O extension module type. |               |
| 16.01                            | Module 3 type          | See parameter 14.01 Module 1 type.   | None          |
| 16.02                            | Module 3 location      | See parameter 14.02 Module 1 location.   | Slot 1        |
| 16.03                            | Module 3 status        | See parameter 14.03 Module 1 status.   | No option     |
| 16.05                            | DI status              | (Visible when 16.01 Module 3 type = FDIO-01)<br>See parameter 14.05 DI status.   | -             |
| 16.05                            | DIO status             | (Visible when 16.01 Module 3 type = FIO-01 or FIO-11)<br>See parameter 14.05 DIO status.   | -             |
| 16.06                            | DI delayed status      | (Visible when 16.01 Module 3 type = FDIO-01)<br>See parameter 14.06 DI delayed status.   | -             |
| 16.06                            | DIO delayed status     | (Visible when 16.01 Module 3 type = FIO-01 or FIO-11)<br>See parameter 14.06 DIO delayed status.   | -             |
| 16.08                            | DI filter time         | (Visible when 16.01 Module 3 type = FDIO-01)<br>See parameter 14.08 DI filter time.  | 10.0 ms       |
| 16.08                            | DIO filter time        | (Visible when 16.01 Module 3 type = FIO-01 or FIO-11)<br>See parameter 14.08 DIO filter time.  | 10.0 ms       |
| 16.09                            | DIO1 function          | (Visible when 16.01 Module 3 type = FIO-01 or FIO-11)<br>See parameter 14.09 DIO1 function.  | Input         |
| 16.11                            | DIO1 output source     | (Visible when 16.01 Module 3 type = FIO-01 or FIO-11)<br>See parameter 14.11 DIO1 output source.   | Not energized |
| 16.12                            | DI1 ON delay           | (Visible when 16.01 Module 3 type = FDIO-01)<br>See parameter 14.12 DI1 ON delay.  | 0.00 s        |
| 16.12                            | DIO1 ON delay          | (Visible when 16.01 Module 3 type = FIO-01 or FIO-11)<br>See parameter 14.12 DIO1 ON delay.  | 0.00 s        |
| 16.13                            | DI1 OFF delay          | (Visible when 16.01 Module 3 type = FDIO-01)<br>See parameter 14.13 DI1 OFF delay.   | 0.00 s        |

| No.   | Name/Value                      | Description   | Def/FbEq16    |
|-------|---------------------------------|---|---------------|
| 16.13 | <i>DIO1 OFF delay</i>           | (Visible when 16.01 Module 3 type = FIO-01 or FIO-11)<br>See parameter 14.13 DIO1 OFF delay.            | 0.00 s        |
| 16.14 | <i>DIO2 function</i>            | (Visible when 16.01 Module 3 type = FIO-01 or FIO-11)<br>See parameter 14.14 DIO2 function.             | Input         |
| 16.16 | <i>DIO2 output source</i>       | (Visible when 16.01 Module 3 type = FIO-01 or FIO-11)<br>See parameter 14.16 DIO2 output source.        | Not energized |
| 16.17 | <i>DI2 ON delay</i>             | (Visible when 16.01 Module 3 type = FDIO-01)<br>See parameter 14.17 DI2 ON delay.                       | 0.00 s        |
| 16.17 | <i>DIO2 ON delay</i>            | (Visible when 16.01 Module 3 type = FIO-01 or FIO-11)<br>See parameter 14.17 DIO2 ON delay.             | 0.00 s        |
| 16.18 | <i>DI2 OFF delay</i>            | (Visible when 16.01 Module 3 type = FDIO-01)<br>See parameter 14.18 DI2 OFF delay.                      | 0.00 s        |
| 16.18 | <i>DIO2 OFF delay</i>           | (Visible when 16.01 Module 3 type = FIO-01 or FIO-11)<br>See parameter 14.18 DIO2 OFF delay.            | 0.00 s        |
| 16.19 | <i>DIO3 function</i>            | (Visible when 16.01 Module 3 type = FIO-01)<br>See parameter 14.19 DIO3 function.                       | Input         |
| 16.19 | <i>AI supervision function</i>  | (Visible when 16.01 Module 3 type = FIO-11 or FAIO-01)<br>See parameter 14.19 AI supervision function.  | No action     |
| 16.20 | <i>AI supervision selection</i> | (Visible when 16.01 Module 3 type = FIO-11 or FAIO-01)<br>See parameter 14.20 AI supervision selection. | 0000 0000b    |
| 16.21 | <i>DIO3 output source</i>       | (Visible when 16.01 Module 3 type = FIO-01)<br>See parameter 14.21 DIO3 output source.                  | Not energized |
| 16.21 | <i>AI tune</i>                  | (Visible when 16.01 Module 3 type = FIO-11 or FAIO-01)<br>See parameter 14.21 AI tune.                  | No action     |
| 16.22 | <i>DI3 ON delay</i>             | (Visible when 16.01 Module 3 type = FDIO-01)<br>See parameter 14.22 DI3 ON delay.                       | 0.00 s        |
| 16.22 | <i>DIO3 ON delay</i>            | (Visible when 16.01 Module 3 type = FIO-01)<br>See parameter 14.22 DIO3 ON delay.                       | 0.00 s        |
| 16.22 | <i>AI force selection</i>       | (Visible when 16.01 Module 3 type = FIO-11 or FAIO-01)<br>See parameter 14.22 AI force selection.       | 0000b         |
| 16.23 | <i>DI3 OFF delay</i>            | (Visible when 16.01 Module 3 type = FDIO-01)<br>See parameter 14.23 DI3 OFF delay.                      | 0.00 s        |
| 16.23 | <i>DIO3 OFF delay</i>           | (Visible when 16.01 Module 3 type = FIO-01)<br>See parameter 14.23 DIO3 OFF delay.                      | 0.00 s        |
| 16.24 | <i>DIO4 function</i>            | (Visible when 16.01 Module 3 type = FIO-01)<br>See parameter 14.24 DIO4 function.                       | Input         |
| 16.26 | <i>DIO4 output source</i>       | (Visible when 16.01 Module 3 type = FIO-01)<br>See parameter 14.26 DIO4 output source.                  | Not energized |
| 16.26 | <i>AI1 actual value</i>         | (Visible when 16.01 Module 3 type = FIO-11 or FAIO-01)<br>See parameter 14.26 AI1 actual value.         | -             |
| 16.27 | <i>DIO4 ON delay</i>            | (Visible when 16.01 Module 3 type = FIO-01)<br>See parameter 14.27 DIO4 ON delay.                       | 0.00 s        |
| 16.27 | <i>AI1 scaled value</i>         | (Visible when 16.01 Module 3 type = FIO-11 or FAIO-01)<br>See parameter 14.27 AI1 scaled value.         | -             |
| 16.28 | <i>DIO4 OFF delay</i>           | (Visible when 16.01 Module 3 type = FIO-01)<br>See parameter 14.28 DIO4 OFF delay.                      | 0.00 s        |



## 190 Parameters

| No.   | Name/Value             | Description   | Def/FbEq16     |
|-------|------------------------|---|----------------|
| 16.28 | AI1 force data         | (Visible when 16.01 Module 3 type = FIO-11 or FAIO-01)<br>See parameter 14.28 AI1 force data.         | 0.000 mA       |
| 16.29 | AI1 HW switch position | (Visible when 16.01 Module 3 type = FIO-11 or FAIO-01)<br>See parameter 14.29 AI1 HW switch position. | -              |
| 16.30 | AI1 unit selection     | (Visible when 16.01 Module 3 type = FIO-11 or FAIO-01)<br>See parameter 14.30 AI1 unit selection.     | mA             |
| 16.31 | RO status              | (Visible when 16.01 Module 3 type = FIO-11 or FDIO-01)<br>See parameter 14.31 RO status.              | -              |
| 16.31 | AI1 filter gain        | (Visible when 16.01 Module 3 type = FIO-11 or FAIO-01)<br>See parameter 14.31 AI1 filter gain.        | 1 ms           |
| 16.32 | AI1 filter time        | (Visible when 16.01 Module 3 type = FIO-11 or FAIO-01)<br>See parameter 14.32 AI1 filter time.        | 0.100 s        |
| 16.33 | AI1 min                | (Visible when 16.01 Module 3 type = FIO-11 or FAIO-01)<br>See parameter 14.33 AI1 min.                | 0.000 mA or V  |
| 16.34 | RO1 source             | (Visible when 16.01 Module 3 type = FIO-01 or FDIO-01)<br>See parameter 14.34 RO1 source.             | Not energized  |
| 16.34 | AI1 max                | (Visible when 16.01 Module 3 type = FIO-11 or FAIO-01)<br>See parameter 14.34 AI1 max.                | 10.000 mA or V |
| 16.35 | RO1 ON delay           | (Visible when 16.01 Module 3 type = FIO-01 or FDIO-01)<br>See parameter 14.35 RO1 ON delay.           | 0.00 s         |
| 16.35 | AI1 scaled at AI1 min  | (Visible when 16.01 Module 3 type = FIO-11 or FAIO-01)<br>See parameter 14.35 AI1 scaled at AI1 min.  | 0.000          |
| 16.36 | RO1 OFF delay          | (Visible when 16.01 Module 3 type = FIO-01 or FDIO-01)<br>See parameter 14.36 RO1 OFF delay.          | 0.00 s         |
| 16.36 | AI1 scaled at AI1 max  | (Visible when 16.01 Module 3 type = FIO-11 or FAIO-01)<br>See parameter 14.36 AI1 scaled at AI1 max.  | 100.000        |
| 16.37 | RO2 source             | (Visible when 16.01 Module 3 type = FIO-01 or FDIO-01)<br>See parameter 14.37 RO2 source.             | Not energized  |
| 16.38 | RO2 ON delay           | (Visible when 16.01 Module 3 type = FIO-01 or FDIO-01)<br>See parameter 14.38 RO2 ON delay.           | 0.00 s         |
| 16.39 | RO2 OFF delay          | (Visible when 16.01 Module 3 type = FIO-01 or FDIO-01)<br>See parameter 14.39 RO2 OFF delay.          | 0.00 s         |
| 16.41 | AI2 actual value       | (Visible when 16.01 Module 3 type = FIO-11 or FAIO-01)<br>See parameter 14.41 AI2 actual value.       | -              |
| 16.42 | AI2 scaled value       | (Visible when 16.01 Module 3 type = FIO-11 or FAIO-01)<br>See parameter 14.42 AI2 scaled value.       | -              |
| 16.43 | AI2 force data         | (Visible when 16.01 Module 3 type = FIO-11 or FAIO-01)<br>See parameter 14.43 AI2 force data.         | 0.000 mA       |
| 16.44 | AI2 HW switch position | (Visible when 16.01 Module 3 type = FIO-11 or FAIO-01)<br>See parameter 14.44 AI2 HW switch position. | -              |
| 16.45 | AI2 unit selection     | (Visible when 16.01 Module 3 type = FIO-11 or FAIO-01)<br>See parameter 14.45 AI2 unit selection.     | mA             |
| 16.46 | AI2 filter gain        | (Visible when 16.01 Module 3 type = FIO-11 or FAIO-01)<br>See parameter 14.46 AI2 filter gain.        | 1 ms           |
| 16.47 | AI2 filter time        | (Visible when 16.01 Module 3 type = FIO-11 or FAIO-01)<br>See parameter 14.47 AI2 filter time.        | 0.100 s        |

| No.   | Name/Value                    | Description   | Def/FbEq16     |
|-------|-------------------------------|---|----------------|
| 16.48 | <i>AI2 min</i>                | (Visible when 16.01 Module 3 type = FIO-11 or FAIO-01)<br>See parameter 14.48 AI2 min.                | 0.000 mA or V  |
| 16.49 | <i>AI2 max</i>                | (Visible when 16.01 Module 3 type = FIO-11 or FAIO-01)<br>See parameter 14.49 AI2 max.                | 10.000 mA or V |
| 16.50 | <i>AI2 scaled at AI2 min</i>  | (Visible when 16.01 Module 3 type = FIO-11 or FAIO-01)<br>See parameter 14.50 AI2 scaled at AI2 min.  | 0.000          |
| 16.51 | <i>AI2 scaled at AI2 max</i>  | (Visible when 16.01 Module 3 type = FIO-11 or FAIO-01)<br>See parameter 14.51 AI2 scaled at AI2 max.  | 100.000        |
| 16.56 | <i>AI3 actual value</i>       | (Visible when 16.01 Module 3 type = FIO-11)<br>See parameter 14.56 AI3 actual value.                  | -              |
| 16.57 | <i>AI3 scaled value</i>       | (Visible when 16.01 Module 3 type = FIO-11)<br>See parameter 14.57 AI3 scaled value.                  | -              |
| 16.58 | <i>AI3 force data</i>         | (Visible when 16.01 Module 3 type = FIO-11)<br>See parameter 14.58 AI3 force data.                    | 0.000 mA       |
| 16.59 | <i>AI3 HW switch position</i> | (Visible when 16.01 Module 3 type = FIO-11)<br>See parameter 14.59 AI3 HW switch position.            | -              |
| 16.60 | <i>AI3 unit selection</i>     | (Visible when 16.01 Module 3 type = FIO-11)<br>See parameter 14.60 AI3 unit selection.                | <i>mA</i>      |
| 16.61 | <i>AI3 filter gain</i>        | (Visible when 16.01 Module 3 type = FIO-11)<br>See parameter 14.61 AI3 filter gain.                   | <i>1 ms</i>    |
| 16.62 | <i>AI3 filter time</i>        | (Visible when 16.01 Module 3 type = FIO-11)<br>See parameter 14.62 AI3 filter time.                   | 0.100 s        |
| 16.63 | <i>AI3 min</i>                | (Visible when 16.01 Module 3 type = FIO-11)<br>See parameter 14.63 AI3 min.                           | 0.000 mA or V  |
| 16.64 | <i>AI3 max</i>                | (Visible when 16.01 Module 3 type = FIO-11)<br>See parameter 14.64 AI3 max.                           | 10.000 mA or V |
| 16.65 | <i>AI3 scaled at AI3 min</i>  | (Visible when 16.01 Module 3 type = FIO-11)<br>See parameter 14.65 AI3 scaled at AI3 min.             | 0.000          |
| 16.66 | <i>AI3 scaled at AI3 max</i>  | (Visible when 16.01 Module 3 type = FIO-11)<br>See parameter 14.66 AI3 scaled at AI3 max.             | 100.000        |
| 16.71 | <i>AO force selection</i>     | (Visible when 16.01 Module 3 type = FIO-11 or FAIO-01)<br>See parameter 14.71 AO force selection.     | 00b            |
| 16.76 | <i>AO1 actual value</i>       | (Visible when 16.01 Module 3 type = FIO-11 or FAIO-01)<br>See parameter 14.76 AO1 actual value.       | -              |
| 16.77 | <i>AO1 source</i>             | (Visible when 16.01 Module 3 type = FIO-11 or FAIO-01)<br>See parameter 14.77 AO1 source.             | <i>Zero</i>    |
| 16.78 | <i>AO1 force data</i>         | (Visible when 16.01 Module 3 type = FIO-11 or FAIO-01)<br>See parameter 14.78 AO1 force data.         | 0.000 mA       |
| 16.79 | <i>AO1 filter time</i>        | (Visible when 16.01 Module 3 type = FIO-11 or FAIO-01)<br>See parameter 14.79 AO1 filter time.        | 0.100 s        |
| 16.80 | <i>AO1 source min</i>         | (Visible when 16.01 Module 3 type = FIO-11 or FAIO-01)<br>See parameter 14.80 AO1 source min.         | 0.0            |
| 16.81 | <i>AO1 source max</i>         | (Visible when 16.01 Module 3 type = FIO-11 or FAIO-01)<br>See parameter 14.81 AO1 source max.         | 100.0          |
| 16.82 | <i>AO1 out at AO1 src min</i> | (Visible when 16.01 Module 3 type = FIO-11 or FAIO-01)<br>See parameter 14.82 AO1 out at AO1 src min. | 0.000 mA       |

## 192 Parameters

| No.   | Name/Value             | Description   | Def/FbEq16 |
|-------|------------------------|---|------------|
| 16.83 | AO1 out at AO1 src max | (Visible when 16.01 Module 3 type = FIO-11 or FAIO-01)<br>See parameter 14.83 AO1 out at AO1 src max. | 10.000 mA  |
| 16.86 | AO2 actual value       | (Visible when 16.01 Module 3 type = FAIO-01)<br>See parameter 14.86 AO2 actual value.                 | -          |
| 16.87 | AO2 source             | (Visible when 16.01 Module 3 type = FAIO-01)<br>See parameter 14.87 AO2 source.                       | Zero       |
| 16.88 | AO2 force data         | (Visible when 16.01 Module 3 type = FAIO-01)<br>See parameter 14.88 AO2 force data.                   | 0.000 mA   |
| 16.89 | AO2 filter time        | (Visible when 16.01 Module 3 type = FAIO-01)<br>See parameter 14.89 AO2 filter time.                  | 0.100 s    |
| 16.90 | AO2 source min         | (Visible when 16.01 Module 3 type = FAIO-01)<br>See parameter 14.90 AO2 source min.                   | 0.0        |
| 16.91 | AO2 source max         | (Visible when 16.01 Module 3 type = FAIO-01)<br>See parameter 14.91 AO2 source max.                   | 100.0      |
| 16.92 | AO2 out at AO2 src min | (Visible when 16.01 Module 3 type = FAIO-01)<br>See parameter 14.92 AO2 out at AO2 src min.           | 0.000 mA   |
| 16.93 | AO2 out at AO2 src max | (Visible when 16.01 Module 3 type = FAIO-01)<br>See parameter 14.93 AO2 out at AO2 src max.           | 10.000 mA  |

|                          |                       |   |      |
|--------------------------|-----------------------|---|------|
| <b>19 Operation mode</b> |                       | Selection of local and external control location sources and operating modes.<br>See also section <i>Operating modes of the drive</i> (page 22).  |      |
| 19.01                    | Actual operation mode | Displays the operating mode currently used.<br>See parameters 19.11...19.14.<br>This parameter is read-only.  | -    |
|                          | Zero                  | None.   | 1    |
|                          | Speed                 | Speed control (in DTC motor control mode).  | 2    |
|                          | Torque                | Torque control (in DTC motor control mode).   | 3    |
|                          | Min                   | The torque selector is comparing the output of the speed controller (25.01 <i>Torque reference speed control</i> ) and torque reference (26.74 <i>Torque ref ramp out</i> ) and the smaller of the two is used. | 4    |
|                          | Max                   | The torque selector is comparing the output of the speed controller (25.01 <i>Torque reference speed control</i> ) and torque reference (26.74 <i>Torque ref ramp out</i> ) and the greater of the two is used. | 5    |
|                          | Add                   | The speed controller output is added to the torque reference.   | 6    |
|                          | Scalar (Hz)           | Frequency control in scalar motor control mode.   | 10   |
|                          | Scalar (rpm)          | Speed control in scalar motor control mode.   | 11   |
|                          | Forced magn.          | Motor is in magnetizing mode.   | 20   |
| 19.11                    | Ext1/Ext2 selection   | Selects the source for external control location EXT1/EXT2 selection.<br>0 = EXT1<br>1 = EXT2   | EXT1 |
|                          | EXT1                  | EXT1 (permanently selected).  | 0    |
|                          | EXT2                  | EXT2 (permanently selected).  | 1    |
|                          | FBA A MCW bit 11      | Control word bit 11 received through fieldbus interface A.  | 2    |
|                          | DI1                   | Digital input DI1 (10.02 <i>DI delayed status</i> , bit 0).   | 3    |



| No.          | Name/Value                          | Description  | Def/FbEq16          |
|--------------|-------------------------------------|--|---------------------|
|              | DI2                                 | Digital input DI2 ( <a href="#">10.02 DI delayed status</a> , bit 1).  | 4                   |
|              | DI3                                 | Digital input DI3 ( <a href="#">10.02 DI delayed status</a> , bit 2).  | 5                   |
|              | DI4                                 | Digital input DI4 ( <a href="#">10.02 DI delayed status</a> , bit 3).  | 6                   |
|              | DI5                                 | Digital input DI5 ( <a href="#">10.02 DI delayed status</a> , bit 4).  | 7                   |
|              | DI6                                 | Digital input DI6 ( <a href="#">10.02 DI delayed status</a> , bit 5).  | 8                   |
|              | DIO1                                | Digital input/output DIO1 ( <a href="#">11.02 DIO delayed status</a> , bit 0).   | 11                  |
|              | DIO2                                | Digital input/output DIO2 ( <a href="#">11.02 DIO delayed status</a> , bit 1).   | 12                  |
|              | EFB MCW bit 11                      | Control word bit 11 received through the embedded fieldbus interface.  | 32                  |
|              | <i>Other [bit]</i>                  | Source selection (see <a href="#">Terms and abbreviations</a> on page 112).  | -                   |
| <b>19.12</b> | <b><i>Ext1 control mode</i></b>     | Selects the operating mode for external control location EXT1.   | <b><i>Speed</i></b> |
|              | Zero                                | None.  | 1                   |
|              | Speed                               | Speed control. The torque reference used is <a href="#">25.01 Torque reference speed control</a> (output of the speed reference chain).  | 2                   |
|              | Torque                              | Torque control. The torque reference used is <a href="#">26.74 Torque ref ramp out</a> (output of the torque reference chain).   | 3                   |
|              | Minimum                             | Combination of selections <a href="#">Speed</a> and <a href="#">Torque</a> : the torque selector compares the speed controller output ( <a href="#">25.01 Torque reference speed control</a> ) and the torque reference ( <a href="#">26.74 Torque ref ramp out</a> ) and selects the smaller of the two.<br>If speed error becomes negative, the drive follows the speed controller output until speed error becomes positive again.<br>This prevents the drive from accelerating uncontrollably if the load is lost in torque control. | 4                   |
|              | Maximum                             | Combination of selections <a href="#">Speed</a> and <a href="#">Torque</a> : the torque selector compares the speed controller output ( <a href="#">25.01 Torque reference speed control</a> ) and the torque reference ( <a href="#">26.74 Torque ref ramp out</a> ) and selects the greater of the two.<br>If speed error becomes positive, the drive follows the speed controller output until speed error becomes negative again.<br>This prevents the drive from accelerating uncontrollably if the load is lost in torque control. | 5                   |
|              | Add                                 | Combination of selections <a href="#">Speed</a> and <a href="#">Torque</a> : Torque selector adds the speed reference chain output to the torque reference chain output.   | 6                   |
| <b>19.14</b> | <b><i>Ext2 control mode</i></b>     | Selects the operating mode for external control location EXT2. For the selections, see parameter <a href="#">19.12 Ext1 control mode</a> .   | <b><i>Speed</i></b> |
| <b>19.16</b> | <b><i>Local control mode</i></b>    | Selects the operating mode for local control.  | <b><i>Speed</i></b> |
|              | Speed                               | Speed control. The torque reference used is <a href="#">25.01 Torque reference speed control</a> (output of the speed reference chain).  | 0                   |
|              | Torque                              | Torque control. The torque reference used is <a href="#">26.74 Torque ref ramp out</a> (output of the torque reference chain).   | 1                   |
| <b>19.17</b> | <b><i>Local control disable</i></b> | Enables/disables local control (start and stop buttons on the control panel, and the local controls on the PC tool).<br> <b>WARNING!</b> Before disabling local control, ensure that the control panel is not needed for stopping the drive.  | <b><i>No</i></b>    |
|              | No                                  | Local control enabled.   | 0                   |
|              | Yes                                 | Local control disabled.  | 1                   |

| No.   | Name/Value                           | Description   | Def/FbEq16 |
|-------|--------------------------------------|---|------------|
| 19.20 | <i>Scalar control reference unit</i> | Selects the reference type for scalar motor control mode. See also section <i>Operating modes of the drive</i> (page 22), and parameter <i>99.04 Motor control mode</i> . | <i>Rpm</i> |
|       | Hz                                   | Hz. The reference is taken from parameter <i>28.02 Frequency ref ramp output</i> (output of the frequency control chain).   | 0          |
|       | Rpm                                  | Rpm. The reference is taken from parameter <i>23.02 Speed ref ramp output</i> (speed reference after ramping and shaping).  | 1          |

|                                |  |  |
|--------------------------------|--|--|
| <b>20 Start/stop/direction</b> | Start/stop/direction and run/start/jog enable signal source selection; positive/negative reference enable signal source selection.<br>For information on control locations, see section <i>Local control vs. external control</i> (page 20). |  |
|--------------------------------|--|--|

|       |                      |   |                           |
|-------|----------------------|---|---------------------------|
| 20.01 | <i>Ext1 commands</i> | Selects the source of start, stop and direction commands for external control location 1 (EXT1). See also parameters <i>20.02...20.05</i> . | <i>In1 Start; In2 Dir</i> |
|-------|----------------------|---|---------------------------|

|  |              |  |   |
|--|--------------|--|---|
|  | Not selected | No start or stop command sources selected. | 0 |
|--|--------------|--|---|

|                               | In1 Start | The source of the start and stop commands is selected by parameter <i>20.03 Ext1 in1 source</i> . The state transitions of the source bits are interpreted as follows:  | 1                         |         |                               |       |                           |      |   |      |  |
|-------------------------------|-----------|---|---------------------------|---------|-------------------------------|-------|---------------------------|------|---|------|--|
|                               |           | <table border="1" style="margin-left: 20px;"> <thead> <tr> <th>State of source 1 (20.03)</th> <th>Command</th> </tr> </thead> <tbody> <tr> <td>0 -&gt; 1 (20.02 = <i>Edge</i>)</td> <td>Start</td> </tr> <tr> <td>1 (20.02 = <i>Level</i>)</td> <td>Stop</td> </tr> <tr> <td>0</td> <td>Stop</td> </tr> </tbody> </table> | State of source 1 (20.03) | Command | 0 -> 1 (20.02 = <i>Edge</i> ) | Start | 1 (20.02 = <i>Level</i> ) | Stop | 0 | Stop |  |
| State of source 1 (20.03)     | Command   |   |                           |         |                               |       |                           |      |   |      |  |
| 0 -> 1 (20.02 = <i>Edge</i> ) | Start     |   |                           |         |                               |       |                           |      |   |      |  |
| 1 (20.02 = <i>Level</i> )     | Stop      |   |                           |         |                               |       |                           |      |   |      |  |
| 0                             | Stop      |   |                           |         |                               |       |                           |      |   |      |  |

|                               | In1 Start; In2 Dir        | The source selected by <i>20.03 Ext1 in1 source</i> is the start signal; the source selected by <i>20.04 Ext1 in2 source</i> determines the direction. The state transitions of the source bits are interpreted as follows:  | 2                         |                           |         |   |     |      |                               |   |               |                           |   |               |  |
|-------------------------------|---------------------------|--|---------------------------|---------------------------|---------|---|-----|------|-------------------------------|---|---------------|---------------------------|---|---------------|--|
|                               |                           | <table border="1" style="margin-left: 20px;"> <thead> <tr> <th>State of source 1 (20.03)</th> <th>State of source 2 (20.04)</th> <th>Command</th> </tr> </thead> <tbody> <tr> <td>0</td> <td>Any</td> <td>Stop</td> </tr> <tr> <td>0 -&gt; 1 (20.02 = <i>Edge</i>)</td> <td>0</td> <td>Start forward</td> </tr> <tr> <td>1 (20.02 = <i>Level</i>)</td> <td>1</td> <td>Start reverse</td> </tr> </tbody> </table> | State of source 1 (20.03) | State of source 2 (20.04) | Command | 0 | Any | Stop | 0 -> 1 (20.02 = <i>Edge</i> ) | 0 | Start forward | 1 (20.02 = <i>Level</i> ) | 1 | Start reverse |  |
| State of source 1 (20.03)     | State of source 2 (20.04) | Command  |                           |                           |         |   |     |      |                               |   |               |                           |   |               |  |
| 0                             | Any                       | Stop   |                           |                           |         |   |     |      |                               |   |               |                           |   |               |  |
| 0 -> 1 (20.02 = <i>Edge</i> ) | 0                         | Start forward  |                           |                           |         |   |     |      |                               |   |               |                           |   |               |  |
| 1 (20.02 = <i>Level</i> )     | 1                         | Start reverse  |                           |                           |         |   |     |      |                               |   |               |                           |   |               |  |

|                               | In1 Start fwd; In2 Start rev  | The source selected by <i>20.03 Ext1 in1 source</i> is the forward start signal; the source selected by <i>20.04 Ext1 in2 source</i> is the reverse start signal. The state transitions of the source bits are interpreted as follows:   | 3                         |                           |         |   |   |      |                               |   |               |                           |   |               |   |                               |               |   |                           |               |   |   |      |  |
|-------------------------------|-------------------------------|--|---------------------------|---------------------------|---------|---|---|------|-------------------------------|---|---------------|---------------------------|---|---------------|---|-------------------------------|---------------|---|---------------------------|---------------|---|---|------|--|
|                               |                               | <table border="1" style="margin-left: 20px;"> <thead> <tr> <th>State of source 1 (20.03)</th> <th>State of source 2 (20.04)</th> <th>Command</th> </tr> </thead> <tbody> <tr> <td>0</td> <td>0</td> <td>Stop</td> </tr> <tr> <td>0 -&gt; 1 (20.02 = <i>Edge</i>)</td> <td>0</td> <td>Start forward</td> </tr> <tr> <td>1 (20.02 = <i>Level</i>)</td> <td>0</td> <td>Start forward</td> </tr> <tr> <td>0</td> <td>0 -&gt; 1 (20.02 = <i>Edge</i>)</td> <td>Start reverse</td> </tr> <tr> <td>1</td> <td>1 (20.02 = <i>Level</i>)</td> <td>Start reverse</td> </tr> <tr> <td>1</td> <td>1</td> <td>Stop</td> </tr> </tbody> </table> | State of source 1 (20.03) | State of source 2 (20.04) | Command | 0 | 0 | Stop | 0 -> 1 (20.02 = <i>Edge</i> ) | 0 | Start forward | 1 (20.02 = <i>Level</i> ) | 0 | Start forward | 0 | 0 -> 1 (20.02 = <i>Edge</i> ) | Start reverse | 1 | 1 (20.02 = <i>Level</i> ) | Start reverse | 1 | 1 | Stop |  |
| State of source 1 (20.03)     | State of source 2 (20.04)     | Command  |                           |                           |         |   |   |      |                               |   |               |                           |   |               |   |                               |               |   |                           |               |   |   |      |  |
| 0                             | 0                             | Stop   |                           |                           |         |   |   |      |                               |   |               |                           |   |               |   |                               |               |   |                           |               |   |   |      |  |
| 0 -> 1 (20.02 = <i>Edge</i> ) | 0                             | Start forward  |                           |                           |         |   |   |      |                               |   |               |                           |   |               |   |                               |               |   |                           |               |   |   |      |  |
| 1 (20.02 = <i>Level</i> )     | 0                             | Start forward  |                           |                           |         |   |   |      |                               |   |               |                           |   |               |   |                               |               |   |                           |               |   |   |      |  |
| 0                             | 0 -> 1 (20.02 = <i>Edge</i> ) | Start reverse  |                           |                           |         |   |   |      |                               |   |               |                           |   |               |   |                               |               |   |                           |               |   |   |      |  |
| 1                             | 1 (20.02 = <i>Level</i> )     | Start reverse  |                           |                           |         |   |   |      |                               |   |               |                           |   |               |   |                               |               |   |                           |               |   |   |      |  |
| 1                             | 1                             | Stop   |                           |                           |         |   |   |      |                               |   |               |                           |   |               |   |                               |               |   |                           |               |   |   |      |  |

| No.                          | Name/Value                                  | Description   | Def/FbEq16                   |                              |                              |         |        |       |     |               |        |        |   |               |     |     |     |      |   |
|------------------------------|---|---|------------------------------|------------------------------|------------------------------|---------|--------|-------|-----|---------------|--------|--------|---|---------------|-----|-----|-----|------|---|
|                              | In1P Start; In2 Stop                        | <p>The sources of the start and stop commands are selected by parameters <a href="#">20.03 Ext1 in1 source</a> and <a href="#">20.04 Ext1 in2 source</a>. The state transitions of the source bits are interpreted as follows:</p> <table border="1" data-bbox="550 389 1263 533"> <thead> <tr> <th data-bbox="550 389 816 456">State of source 1<br/>(20.03)</th> <th data-bbox="816 389 1083 456">State of source 2<br/>(20.04)</th> <th data-bbox="1083 389 1263 456">Command</th> </tr> </thead> <tbody> <tr> <td data-bbox="550 456 816 495">0 -&gt; 1</td> <td data-bbox="816 456 1083 495">1</td> <td data-bbox="1083 456 1263 495">Start</td> </tr> <tr> <td data-bbox="550 495 816 533">Any</td> <td data-bbox="816 495 1083 533">0</td> <td data-bbox="1083 495 1263 533">Stop</td> </tr> </tbody> </table> <p><b>Note:</b> The start signal is always edge-triggered with this setting regardless of parameter <a href="#">20.02 Ext1 start trigger type</a>.</p>  | State of source 1<br>(20.03) | State of source 2<br>(20.04) | Command                      | 0 -> 1  | 1      | Start | Any | 0             | Stop   | 4      |   |               |     |     |     |      |   |
| State of source 1<br>(20.03) | State of source 2<br>(20.04)                | Command   |                              |                              |                              |         |        |       |     |               |        |        |   |               |     |     |     |      |   |
| 0 -> 1                       | 1   | Start   |                              |                              |                              |         |        |       |     |               |        |        |   |               |     |     |     |      |   |
| Any                          | 0   | Stop  |                              |                              |                              |         |        |       |     |               |        |        |   |               |     |     |     |      |   |
|                              | In1P Start; In2 Stop;<br>In3 Dir            | <p>The sources of the start and stop commands are selected by parameters <a href="#">20.03 Ext1 in1 source</a> and <a href="#">20.04 Ext1 in2 source</a>. The source selected by <a href="#">20.05 Ext1 in3 source</a> determines the direction. The state transitions of the source bits are interpreted as follows:</p> <table border="1" data-bbox="550 808 1263 1016"> <thead> <tr> <th data-bbox="550 808 730 904">State of source 1<br/>(20.03)</th> <th data-bbox="730 808 911 904">State of source 2<br/>(20.04)</th> <th data-bbox="911 808 1091 904">State of source 3<br/>(20.05)</th> <th data-bbox="1091 808 1263 904">Command</th> </tr> </thead> <tbody> <tr> <td data-bbox="550 904 730 943">0 -&gt; 1</td> <td data-bbox="730 904 911 943">1</td> <td data-bbox="911 904 1091 943">0</td> <td data-bbox="1091 904 1263 943">Start forward</td> </tr> <tr> <td data-bbox="550 943 730 981">0 -&gt; 1</td> <td data-bbox="730 943 911 981">1</td> <td data-bbox="911 943 1091 981">1</td> <td data-bbox="1091 943 1263 981">Start reverse</td> </tr> <tr> <td data-bbox="550 981 730 1016">Any</td> <td data-bbox="730 981 911 1016">0</td> <td data-bbox="911 981 1091 1016">Any</td> <td data-bbox="1091 981 1263 1016">Stop</td> </tr> </tbody> </table> <p><b>Note:</b> The start signal is always edge-triggered with this setting regardless of parameter <a href="#">20.02 Ext1 start trigger type</a>.</p> | State of source 1<br>(20.03) | State of source 2<br>(20.04) | State of source 3<br>(20.05) | Command | 0 -> 1 | 1     | 0   | Start forward | 0 -> 1 | 1      | 1 | Start reverse | Any | 0   | Any | Stop | 5 |
| State of source 1<br>(20.03) | State of source 2<br>(20.04)                | State of source 3<br>(20.05)  | Command                      |                              |                              |         |        |       |     |               |        |        |   |               |     |     |     |      |   |
| 0 -> 1                       | 1   | 0   | Start forward                |                              |                              |         |        |       |     |               |        |        |   |               |     |     |     |      |   |
| 0 -> 1                       | 1   | 1   | Start reverse                |                              |                              |         |        |       |     |               |        |        |   |               |     |     |     |      |   |
| Any                          | 0   | Any   | Stop                         |                              |                              |         |        |       |     |               |        |        |   |               |     |     |     |      |   |
|                              | In1P Start fwd; In2P<br>Start rev; In3 Stop | <p>The sources of the start and stop commands are selected by parameters <a href="#">20.03 Ext1 in1 source</a>, <a href="#">20.04 Ext1 in2 source</a> and <a href="#">20.05 Ext1 in3 source</a>. The state transitions of the source bits are interpreted as follows:</p> <table border="1" data-bbox="550 1263 1263 1471"> <thead> <tr> <th data-bbox="550 1263 730 1359">State of source 1<br/>(20.03)</th> <th data-bbox="730 1263 911 1359">State of source 2<br/>(20.04)</th> <th data-bbox="911 1263 1091 1359">State of source 3<br/>(20.05)</th> <th data-bbox="1091 1263 1263 1359">Command</th> </tr> </thead> <tbody> <tr> <td data-bbox="550 1359 730 1397">0 -&gt; 1</td> <td data-bbox="730 1359 911 1397">Any</td> <td data-bbox="911 1359 1091 1397">1</td> <td data-bbox="1091 1359 1263 1397">Start forward</td> </tr> <tr> <td data-bbox="550 1397 730 1435">Any</td> <td data-bbox="730 1397 911 1435">0 -&gt; 1</td> <td data-bbox="911 1397 1091 1435">1</td> <td data-bbox="1091 1397 1263 1435">Start reverse</td> </tr> <tr> <td data-bbox="550 1435 730 1471">Any</td> <td data-bbox="730 1435 911 1471">Any</td> <td data-bbox="911 1435 1091 1471">0</td> <td data-bbox="1091 1435 1263 1471">Stop</td> </tr> </tbody> </table> <p><b>Note:</b> The start signal is always edge-triggered with this setting regardless of parameter <a href="#">20.02 Ext1 start trigger type</a>.</p>                | State of source 1<br>(20.03) | State of source 2<br>(20.04) | State of source 3<br>(20.05) | Command | 0 -> 1 | Any   | 1   | Start forward | Any    | 0 -> 1 | 1 | Start reverse | Any | Any | 0   | Stop | 6 |
| State of source 1<br>(20.03) | State of source 2<br>(20.04)                | State of source 3<br>(20.05)  | Command                      |                              |                              |         |        |       |     |               |        |        |   |               |     |     |     |      |   |
| 0 -> 1                       | Any   | 1   | Start forward                |                              |                              |         |        |       |     |               |        |        |   |               |     |     |     |      |   |
| Any                          | 0 -> 1                                      | 1   | Start reverse                |                              |                              |         |        |       |     |               |        |        |   |               |     |     |     |      |   |
| Any                          | Any   | 0   | Stop                         |                              |                              |         |        |       |     |               |        |        |   |               |     |     |     |      |   |
|                              | Control panel                               | The start and stop commands are taken from the control panel.   | 11                           |                              |                              |         |        |       |     |               |        |        |   |               |     |     |     |      |   |
|                              | Fieldbus A                                  | The start and stop commands are taken from fieldbus adapter A.<br><b>Note:</b> The start signal is always level-triggered with this setting regardless of parameter <a href="#">20.02 Ext1 start trigger type</a> .   | 12                           |                              |                              |         |        |       |     |               |        |        |   |               |     |     |     |      |   |
|                              | Embedded fieldbus                           | The start and stop commands are taken from the embedded fieldbus interface.<br><b>Note:</b> The start signal is always level-triggered with this setting regardless of parameter <a href="#">20.02 Ext1 start trigger type</a> .  | 14                           |                              |                              |         |        |       |     |               |        |        |   |               |     |     |     |      |   |
|                              | M/F link                                    | The start and stop commands are taken from another drive through the master/follower link.<br><b>Note:</b> The start signal is always level-triggered with this setting regardless of parameter <a href="#">20.02 Ext1 start trigger type</a> .   | 15                           |                              |                              |         |        |       |     |               |        |        |   |               |     |     |     |      |   |

| No.   | Name/Value                              | Description   | Def/FbEq16                                  |         |   |       |   |      |   |      |   |
|---|---|---|---|---------|---|-------|---|------|---|------|---|
|   | Application Program                     | The start and stop commands are taken from the application program control word (parameter <a href="#">06.02 Application control word</a> ).<br><b>Note:</b> The start signal is always level-triggered with this setting regardless of parameter <a href="#">20.02 Ext1 start trigger type</a> .   | 21  |         |   |       |   |      |   |      |   |
|   | ATF                                     | Reserved.   | 22  |         |   |       |   |      |   |      |   |
|   | DDCS controller                         | The start and stop commands are taken from an external (DDCS) controller.<br><b>Note:</b> The start signal is always level-triggered with this setting regardless of parameter <a href="#">20.02 Ext1 start trigger type</a> .  | 16  |         |   |       |   |      |   |      |   |
| <a href="#">20.02</a>                                   | <a href="#">Ext1 start trigger type</a> | Defines whether the start signal for external control location EXT1 is edge-triggered or level-triggered.<br><b>Note:</b> This parameter is only effective when parameter <a href="#">20.01 Ext1 commands</a> is set to <a href="#">In1 Start</a> , <a href="#">In1 Start; In2 Dir</a> , <a href="#">In1 Start fwd</a> ; <a href="#">In2 Start rev</a> , or <a href="#">Control panel</a> .   | <a href="#">Edge</a>                        |         |   |       |   |      |   |      |   |
|   | Edge                                    | The start signal is edge-triggered.   | 0   |         |   |       |   |      |   |      |   |
|   | Level                                   | The start signal is level-triggered.  | 1   |         |   |       |   |      |   |      |   |
| <a href="#">20.03</a>                                   | <a href="#">Ext1 in1 source</a>         | Selects source 1 for parameter <a href="#">20.01 Ext1 commands</a> .  | <a href="#">DI1</a>                         |         |   |       |   |      |   |      |   |
|   | Not selected                            | 0 (always off).   | 0   |         |   |       |   |      |   |      |   |
|   | Selected                                | 1 (always on).  | 1   |         |   |       |   |      |   |      |   |
|   | DI1                                     | Digital input DI1 ( <a href="#">10.02 DI delayed status</a> , bit 0).   | 2   |         |   |       |   |      |   |      |   |
|   | DI2                                     | Digital input DI2 ( <a href="#">10.02 DI delayed status</a> , bit 1).   | 3   |         |   |       |   |      |   |      |   |
|   | DI3                                     | Digital input DI3 ( <a href="#">10.02 DI delayed status</a> , bit 2).   | 4   |         |   |       |   |      |   |      |   |
|   | DI4                                     | Digital input DI4 ( <a href="#">10.02 DI delayed status</a> , bit 3).   | 5   |         |   |       |   |      |   |      |   |
|   | DI5                                     | Digital input DI5 ( <a href="#">10.02 DI delayed status</a> , bit 4).   | 6   |         |   |       |   |      |   |      |   |
|   | DI6                                     | Digital input DI6 ( <a href="#">10.02 DI delayed status</a> , bit 5).   | 7   |         |   |       |   |      |   |      |   |
|   | DIO1                                    | Digital input/output DIO1 ( <a href="#">11.02 DIO delayed status</a> , bit 0).  | 10  |         |   |       |   |      |   |      |   |
|   | DIO2                                    | Digital input/output DIO2 ( <a href="#">11.02 DIO delayed status</a> , bit 1).  | 11  |         |   |       |   |      |   |      |   |
|   | <a href="#">Other [bit]</a>             | Source selection (see <a href="#">Terms and abbreviations</a> on page 112).   | -   |         |   |       |   |      |   |      |   |
| <a href="#">20.04</a>                                   | <a href="#">Ext1 in2 source</a>         | Selects source 2 for parameter <a href="#">20.01 Ext1 commands</a> .<br>For the available selections, see parameter <a href="#">20.03 Ext1 in1 source</a> .   | <a href="#">DI2</a>                         |         |   |       |   |      |   |      |   |
| <a href="#">20.05</a>                                   | <a href="#">Ext1 in3 source</a>         | Selects source 3 for parameter <a href="#">20.01 Ext1 commands</a> .<br>For the available selections, see parameter <a href="#">20.03 Ext1 in1 source</a> .   | <a href="#">Not selected</a>                |         |   |       |   |      |   |      |   |
| <a href="#">20.06</a>                                   | <a href="#">Ext2 commands</a>           | Selects the source of start, stop and direction commands for external control location 2 (EXT2).<br>See also parameters <a href="#">20.07</a> ... <a href="#">20.10</a> .   | <a href="#">Not selected</a>                |         |   |       |   |      |   |      |   |
|   | Not selected                            | No start or stop command sources selected.  | 0   |         |   |       |   |      |   |      |   |
|   | In1 Start                               | The source of the start and stop commands is selected by parameter <a href="#">20.08 Ext2 in1 source</a> . The state transitions of the source bits are interpreted as follows:<br><table border="1" data-bbox="478 1883 965 2033"> <thead> <tr> <th>State of source 1 (<a href="#">20.08</a>)</th> <th>Command</th> </tr> </thead> <tbody> <tr> <td>0 -&gt; 1 (<a href="#">20.07</a> = <a href="#">Edge</a>)</td> <td>Start</td> </tr> <tr> <td>1 (<a href="#">20.07</a> = <a href="#">Level</a>)</td> <td>Stop</td> </tr> <tr> <td>0</td> <td>Stop</td> </tr> </tbody> </table> | State of source 1 ( <a href="#">20.08</a> ) | Command | 0 -> 1 ( <a href="#">20.07</a> = <a href="#">Edge</a> ) | Start | 1 ( <a href="#">20.07</a> = <a href="#">Level</a> ) | Stop | 0 | Stop | 1 |
| State of source 1 ( <a href="#">20.08</a> )             | Command                                 |   |   |         |   |       |   |      |   |      |   |
| 0 -> 1 ( <a href="#">20.07</a> = <a href="#">Edge</a> ) | Start                                   |   |   |         |   |       |   |      |   |      |   |
| 1 ( <a href="#">20.07</a> = <a href="#">Level</a> )     | Stop                                    |   |   |         |   |       |   |      |   |      |   |
| 0   | Stop                                    |   |   |         |   |       |   |      |   |      |   |

| No.  | Name/Value   | Description   | Def/FbEq16                                     |  |  |         |        |       |  |               |               |                                     |  |               |     |   |      |      |   |
|--|--|---|--|--|--|---------|--------|-------|--|---------------|---------------|-------------------------------------|--|---------------|-----|---|------|------|---|
|  | In1 Start; In2 Dir   | <p>The source selected by <a href="#">20.08 Ext2 in1 source</a> is the start signal; the source selected by <a href="#">20.09 Ext2 in2 source</a> determines the direction. The state transitions of the source bits are interpreted as follows:</p> <table border="1"> <thead> <tr> <th>State of source 1<br/>(<a href="#">20.08</a>)</th> <th>State of source 2<br/>(<a href="#">20.09</a>)</th> <th>Command</th> </tr> </thead> <tbody> <tr> <td>0</td> <td>Any</td> <td>Stop</td> </tr> <tr> <td>0 -&gt; 1 (<a href="#">20.07 = Edge</a>)</td> <td>0</td> <td>Start forward</td> </tr> <tr> <td>1 (<a href="#">20.07 = Level</a>)</td> <td>1</td> <td>Start reverse</td> </tr> </tbody> </table>  | State of source 1<br>( <a href="#">20.08</a> ) | State of source 2<br>( <a href="#">20.09</a> ) | Command  | 0       | Any    | Stop  | 0 -> 1 ( <a href="#">20.07 = Edge</a> )  | 0             | Start forward | 1 ( <a href="#">20.07 = Level</a> ) | 1  | Start reverse | 2   |   |      |      |   |
| State of source 1<br>( <a href="#">20.08</a> )                                 | State of source 2<br>( <a href="#">20.09</a> )                                 | Command   |  |  |  |         |        |       |  |               |               |                                     |  |               |     |   |      |      |   |
| 0  | Any  | Stop  |  |  |  |         |        |       |  |               |               |                                     |  |               |     |   |      |      |   |
| 0 -> 1 ( <a href="#">20.07 = Edge</a> )  | 0  | Start forward   |  |  |  |         |        |       |  |               |               |                                     |  |               |     |   |      |      |   |
| 1 ( <a href="#">20.07 = Level</a> )  | 1  | Start reverse   |  |  |  |         |        |       |  |               |               |                                     |  |               |     |   |      |      |   |
|  | In1 Start fwd; In2 Start rev   | <p>The source selected by <a href="#">20.08 Ext2 in1 source</a> is the forward start signal; the source selected by <a href="#">20.09 Ext2 in2 source</a> is the reverse start signal. The state transitions of the source bits are interpreted as follows:</p> <table border="1"> <thead> <tr> <th>State of source 1<br/>(<a href="#">20.08</a>)</th> <th>State of source 2<br/>(<a href="#">20.09</a>)</th> <th>Command</th> </tr> </thead> <tbody> <tr> <td>0</td> <td>0</td> <td>Stop</td> </tr> <tr> <td>0 -&gt; 1 (<a href="#">20.07 = Edge</a>)<br/>1 (<a href="#">20.07 = Level</a>)</td> <td>0</td> <td>Start forward</td> </tr> <tr> <td>0</td> <td>0 -&gt; 1 (<a href="#">20.07 = Edge</a>)<br/>1 (<a href="#">20.07 = Level</a>)</td> <td>Start reverse</td> </tr> <tr> <td>1</td> <td>1</td> <td>Stop</td> </tr> </tbody> </table>   | State of source 1<br>( <a href="#">20.08</a> ) | State of source 2<br>( <a href="#">20.09</a> ) | Command  | 0       | 0      | Stop  | 0 -> 1 ( <a href="#">20.07 = Edge</a> )<br>1 ( <a href="#">20.07 = Level</a> ) | 0             | Start forward | 0                                   | 0 -> 1 ( <a href="#">20.07 = Edge</a> )<br>1 ( <a href="#">20.07 = Level</a> ) | Start reverse | 1   | 1 | Stop | 3    |   |
| State of source 1<br>( <a href="#">20.08</a> )                                 | State of source 2<br>( <a href="#">20.09</a> )                                 | Command   |  |  |  |         |        |       |  |               |               |                                     |  |               |     |   |      |      |   |
| 0  | 0  | Stop  |  |  |  |         |        |       |  |               |               |                                     |  |               |     |   |      |      |   |
| 0 -> 1 ( <a href="#">20.07 = Edge</a> )<br>1 ( <a href="#">20.07 = Level</a> ) | 0  | Start forward   |  |  |  |         |        |       |  |               |               |                                     |  |               |     |   |      |      |   |
| 0  | 0 -> 1 ( <a href="#">20.07 = Edge</a> )<br>1 ( <a href="#">20.07 = Level</a> ) | Start reverse   |  |  |  |         |        |       |  |               |               |                                     |  |               |     |   |      |      |   |
| 1  | 1  | Stop  |  |  |  |         |        |       |  |               |               |                                     |  |               |     |   |      |      |   |
|  | In1P Start; In2 Stop   | <p>The sources of the start and stop commands are selected by parameters <a href="#">20.08 Ext2 in1 source</a> and <a href="#">20.09 Ext2 in2 source</a>. The state transitions of the source bits are interpreted as follows:</p> <table border="1"> <thead> <tr> <th>State of source 1<br/>(<a href="#">20.08</a>)</th> <th>State of source 2<br/>(<a href="#">20.09</a>)</th> <th>Command</th> </tr> </thead> <tbody> <tr> <td>0 -&gt; 1</td> <td>1</td> <td>Start</td> </tr> <tr> <td>Any</td> <td>0</td> <td>Stop</td> </tr> </tbody> </table> <p><b>Note:</b> The start signal is always edge-triggered with this setting regardless of parameter <a href="#">20.07 Ext2 start trigger type</a>.</p>  | State of source 1<br>( <a href="#">20.08</a> ) | State of source 2<br>( <a href="#">20.09</a> ) | Command  | 0 -> 1  | 1      | Start | Any  | 0             | Stop          | 4                                   |  |               |     |   |      |      |   |
| State of source 1<br>( <a href="#">20.08</a> )                                 | State of source 2<br>( <a href="#">20.09</a> )                                 | Command   |  |  |  |         |        |       |  |               |               |                                     |  |               |     |   |      |      |   |
| 0 -> 1   | 1  | Start   |  |  |  |         |        |       |  |               |               |                                     |  |               |     |   |      |      |   |
| Any  | 0  | Stop  |  |  |  |         |        |       |  |               |               |                                     |  |               |     |   |      |      |   |
|  | In1P Start; In2 Stop;<br>In3 Dir   | <p>The sources of the start and stop commands are selected by parameters <a href="#">20.08 Ext2 in1 source</a> and <a href="#">20.09 Ext2 in2 source</a>. The source selected by <a href="#">20.10 Ext2 in3 source</a> determines the direction. The state transitions of the source bits are interpreted as follows:</p> <table border="1"> <thead> <tr> <th>State of source 1<br/>(<a href="#">20.08</a>)</th> <th>State of source 2<br/>(<a href="#">20.09</a>)</th> <th>State of source 3<br/>(<a href="#">20.10</a>)</th> <th>Command</th> </tr> </thead> <tbody> <tr> <td>0 -&gt; 1</td> <td>1</td> <td>0</td> <td>Start forward</td> </tr> <tr> <td>0 -&gt; 1</td> <td>1</td> <td>1</td> <td>Start reverse</td> </tr> <tr> <td>Any</td> <td>0</td> <td>Any</td> <td>Stop</td> </tr> </tbody> </table> <p><b>Note:</b> The start signal is always edge-triggered with this setting regardless of parameter <a href="#">20.07 Ext2 start trigger type</a>.</p> | State of source 1<br>( <a href="#">20.08</a> ) | State of source 2<br>( <a href="#">20.09</a> ) | State of source 3<br>( <a href="#">20.10</a> ) | Command | 0 -> 1 | 1     | 0  | Start forward | 0 -> 1        | 1                                   | 1  | Start reverse | Any | 0 | Any  | Stop | 5 |
| State of source 1<br>( <a href="#">20.08</a> )                                 | State of source 2<br>( <a href="#">20.09</a> )                                 | State of source 3<br>( <a href="#">20.10</a> )  | Command  |  |  |         |        |       |  |               |               |                                     |  |               |     |   |      |      |   |
| 0 -> 1   | 1  | 0   | Start forward                                  |  |  |         |        |       |  |               |               |                                     |  |               |     |   |      |      |   |
| 0 -> 1   | 1  | 1   | Start reverse                                  |  |  |         |        |       |  |               |               |                                     |  |               |     |   |      |      |   |
| Any  | 0  | Any   | Stop   |  |  |         |        |       |  |               |               |                                     |  |               |     |   |      |      |   |

| No.  | Name/Value                                     | Description   | Def/FbEq16                                     |  |  |         |        |     |   |               |     |        |   |               |     |     |   |      |   |
|--|--|---|--|--|--|---------|--------|-----|---|---------------|-----|--------|---|---------------|-----|-----|---|------|---|
|  | In1P Start fwd; In2P Start rev; In3 Stop       | <p>The sources of the start and stop commands are selected by parameters <a href="#">20.08 Ext2 in1 source</a>, <a href="#">20.09 Ext2 in2 source</a> and <a href="#">20.10 Ext2 in3 source</a>. The state transitions of the source bits are interpreted as follows:</p> <table border="1"> <thead> <tr> <th>State of source 1<br/>(<a href="#">20.08</a>)</th> <th>State of source 2<br/>(<a href="#">20.09</a>)</th> <th>State of source 3<br/>(<a href="#">20.10</a>)</th> <th>Command</th> </tr> </thead> <tbody> <tr> <td>0 -&gt; 1</td> <td>Any</td> <td>1</td> <td>Start forward</td> </tr> <tr> <td>Any</td> <td>0 -&gt; 1</td> <td>1</td> <td>Start reverse</td> </tr> <tr> <td>Any</td> <td>Any</td> <td>0</td> <td>Stop</td> </tr> </tbody> </table> <p><b>Note:</b> The start signal is always edge-triggered with this setting regardless of parameter <a href="#">20.07 Ext2 start trigger type</a>.</p> | State of source 1<br>( <a href="#">20.08</a> ) | State of source 2<br>( <a href="#">20.09</a> ) | State of source 3<br>( <a href="#">20.10</a> ) | Command | 0 -> 1 | Any | 1 | Start forward | Any | 0 -> 1 | 1 | Start reverse | Any | Any | 0 | Stop | 6 |
| State of source 1<br>( <a href="#">20.08</a> ) | State of source 2<br>( <a href="#">20.09</a> ) | State of source 3<br>( <a href="#">20.10</a> )  | Command  |  |  |         |        |     |   |               |     |        |   |               |     |     |   |      |   |
| 0 -> 1   | Any  | 1   | Start forward                                  |  |  |         |        |     |   |               |     |        |   |               |     |     |   |      |   |
| Any  | 0 -> 1   | 1   | Start reverse                                  |  |  |         |        |     |   |               |     |        |   |               |     |     |   |      |   |
| Any  | Any  | 0   | Stop   |  |  |         |        |     |   |               |     |        |   |               |     |     |   |      |   |
|  | Control panel                                  | The start and stop commands are taken from the control panel.   | 11   |  |  |         |        |     |   |               |     |        |   |               |     |     |   |      |   |
|  | Fieldbus A                                     | The start and stop commands are taken from fieldbus adapter A.<br><b>Note:</b> The start signal is always level-triggered with this setting regardless of parameter <a href="#">20.07 Ext2 start trigger type</a> .   | 12   |  |  |         |        |     |   |               |     |        |   |               |     |     |   |      |   |
|  | Embedded fieldbus                              | The start and stop commands are taken from the embedded fieldbus interface.<br><b>Note:</b> The start signal is always level-triggered with this setting regardless of parameter <a href="#">20.07 Ext2 start trigger type</a> .  | 14   |  |  |         |        |     |   |               |     |        |   |               |     |     |   |      |   |
|  | M/F link                                       | The start and stop commands are taken from another drive through the master/follower link.<br><b>Note:</b> The start signal is always level-triggered with this setting regardless of parameter <a href="#">20.07 Ext2 start trigger type</a> .   | 15   |  |  |         |        |     |   |               |     |        |   |               |     |     |   |      |   |
|  | Application Program                            | The start and stop commands are taken from the application program control word (parameter <a href="#">06.02 Application control word</a> ).<br><b>Note:</b> The start signal is always level-triggered with this setting regardless of parameter <a href="#">20.07 Ext2 start trigger type</a> .   | 21   |  |  |         |        |     |   |               |     |        |   |               |     |     |   |      |   |
|  | ATF  | Reserved.   | 22   |  |  |         |        |     |   |               |     |        |   |               |     |     |   |      |   |
|  | DDCS controller                                | The start and stop commands are taken from an external (DDCS) controller.<br><b>Note:</b> The start signal is always level-triggered with this setting regardless of parameter <a href="#">20.07 Ext2 start trigger type</a> .  | 16   |  |  |         |        |     |   |               |     |        |   |               |     |     |   |      |   |
| <a href="#">20.07</a>                          | <a href="#">Ext2 start trigger type</a>        | Defines whether the start signal for external control location EXT2 is edge-triggered or level-triggered.<br><b>Note:</b> This parameter is only effective when parameter <a href="#">20.06 Ext2 commands</a> is set to <a href="#">In1 Start</a> , <a href="#">In1 Start; In2 Dir</a> , <a href="#">In1 Start fwd</a> ; <a href="#">In2 Start rev</a> , or <a href="#">Control panel</a> .   | <a href="#">Edge</a>                           |  |  |         |        |     |   |               |     |        |   |               |     |     |   |      |   |
|  | Edge   | The start signal is edge-triggered.   | 0  |  |  |         |        |     |   |               |     |        |   |               |     |     |   |      |   |
|  | Level  | The start signal is level-triggered.  | 1  |  |  |         |        |     |   |               |     |        |   |               |     |     |   |      |   |
| <a href="#">20.08</a>                          | <a href="#">Ext2 in1 source</a>                | Selects source 1 for parameter <a href="#">20.06 Ext2 commands</a> . For the available selections, see parameter <a href="#">20.03 Ext1 in1 source</a> .  | <a href="#">Not selected</a>                   |  |  |         |        |     |   |               |     |        |   |               |     |     |   |      |   |
| <a href="#">20.09</a>                          | <a href="#">Ext2 in2 source</a>                | Selects source 2 for parameter <a href="#">20.06 Ext2 commands</a> . For the available selections, see parameter <a href="#">20.03 Ext1 in1 source</a> .  | <a href="#">Not selected</a>                   |  |  |         |        |     |   |               |     |        |   |               |     |     |   |      |   |

| No.   | Name/Value                      | Description   | Def/FbEq16  |
|-------|---------------------------------|---|---|
| 20.10 | <i>Ext2 in3 source</i>          | Selects source 3 for parameter <a href="#">20.06 Ext2 commands</a> .<br>For the available selections, see parameter <a href="#">20.03 Ext1 in1 source</a> .   | <i>Not selected</i>   |
| 20.11 | <i>Run enable stop mode</i>     | Selects the way the motor is stopped when the run enable signal switches off.<br>The source of the run enable signal is selected by parameter <a href="#">20.12 Run enable 1 source</a> .   | <i>Coast</i><br>(95.20 b10)   |
|       | Coast                           | Stop by switching off the output semiconductors of the drive. The motor coasts to a stop.<br> <b>WARNING!</b> If a mechanical brake is used, ensure it is safe to stop the drive by coasting.  | 0   |
|       | Ramp                            | Stop along the active deceleration ramp. See parameter group <a href="#">23 Speed reference ramp</a> on page 218.   | 1   |
|       | Torque limit                    | Stop according to torque limits (parameters <a href="#">30.19</a> and <a href="#">30.20</a> ).  | 2   |
| 20.12 | <i>Run enable 1 source</i>      | Selects the source of the external run enable signal. If the run enable signal is switched off, the drive will not start. If already running, the drive will stop according to the setting of parameter <a href="#">20.11 Run enable stop mode</a> .<br>1 = Run enable signal on.<br><b>Note:</b> The warning that indicates a missing signal can be suppressed using parameter <a href="#">20.30 Enable signals warning function</a> .<br>See also parameter <a href="#">20.19 Enable start command</a> .  | <i>DIIL</i><br>(95.20 b10);<br><i>Selected</i><br>(95.20 b5);<br><i>DI5</i><br>(95.20 b9) |
|       | Not selected                    | 0.  | 0   |
|       | Selected                        | 1.  | 1   |
|       | DI1                             | Digital input DI1 ( <a href="#">10.02 DI delayed status</a> , bit 0).   | 2   |
|       | DI2                             | Digital input DI2 ( <a href="#">10.02 DI delayed status</a> , bit 1).   | 3   |
|       | DI3                             | Digital input DI3 ( <a href="#">10.02 DI delayed status</a> , bit 2).   | 4   |
|       | DI4                             | Digital input DI4 ( <a href="#">10.02 DI delayed status</a> , bit 3).   | 5   |
|       | DI5                             | Digital input DI5 ( <a href="#">10.02 DI delayed status</a> , bit 4).   | 6   |
|       | DI6                             | Digital input DI6 ( <a href="#">10.02 DI delayed status</a> , bit 5).   | 7   |
|       | DIO1                            | Digital input/output DIO1 ( <a href="#">11.02 DIO delayed status</a> , bit 0).  | 10  |
|       | DIO2                            | Digital input/output DIO2 ( <a href="#">11.02 DIO delayed status</a> , bit 1).  | 11  |
|       | FBA A MCW bit 3                 | Control word bit 3 received through fieldbus interface A.   | 30  |
|       | EFB MCW bit 3                   | Control word bit 3 received through the embedded fieldbus interface.  | 32  |
|       | DIIL                            | DIIL input ( <a href="#">10.02 DI delayed status</a> , bit 15).   | 33  |
|       | Active control source MCW bit 3 | Control word bit 3 received from the active control source.<br><b>Notes:</b> <ul style="list-style-type: none"> <li>If the drive is running in fieldbus control, switching bit 3 off effectively removes both the start and run enable signals. In this case, the stop mode is determined by either <a href="#">20.11 Run enable stop mode</a> or <a href="#">21.03 Stop mode</a>, whichever mode has higher priority. The order of stop modes from highest to lowest priority is <i>Coast</i> – <i>Torque limit</i> – <i>Ramp</i>.</li> <li>In case the active source is the control panel, PC tool or drive I/O, the run enable signal is always on.</li> </ul> | 34  |
|       | <i>Other [bit]</i>              | Source selection (see <a href="#">Terms and abbreviations</a> on page 112).   | -   |





| No.   | Name/Value                  | Description   | Def/FbEq16      |
|-------|-----------------------------|---|-----------------|
| 20.19 | <i>Enable start command</i> | <p>Selects the source for the start enable signal.<br/>1 = Start enable.</p> <p>With the signal switched off, any drive start command is inhibited. (Switching the signal off while the drive is running will not stop the drive.)</p> <p><b>Notes:</b></p> <ul style="list-style-type: none"> <li>If a level-triggered start command is on when the start enable signal switches on, the drive will start. (An edge-triggered start signal must be cycled for the drive to start.) See parameters <a href="#">20.02 Ext1 start trigger type</a>, <a href="#">20.07 Ext2 start trigger type</a> and <a href="#">20.29 Local start trigger type</a>.</li> <li>The warning that indicates a missing signal can be suppressed using parameter <a href="#">20.30 Enable signals warning function</a>.</li> </ul> <p>See also parameter <a href="#">20.12 Run enable 1 source</a>.</p> | <i>Selected</i> |
|       | Not selected                | 0.  | 0               |
|       | Selected                    | 1.  | 1               |
|       | DI1                         | Digital input DI1 ( <a href="#">10.02 DI delayed status</a> , bit 0).   | 2               |
|       | DI2                         | Digital input DI2 ( <a href="#">10.02 DI delayed status</a> , bit 1).   | 3               |
|       | DI3                         | Digital input DI3 ( <a href="#">10.02 DI delayed status</a> , bit 2).   | 4               |
|       | DI4                         | Digital input DI4 ( <a href="#">10.02 DI delayed status</a> , bit 3).   | 5               |
|       | DI5                         | Digital input DI5 ( <a href="#">10.02 DI delayed status</a> , bit 4).   | 6               |
|       | DI6                         | Digital input DI6 ( <a href="#">10.02 DI delayed status</a> , bit 5).   | 7               |
|       | DIO1                        | Digital input/output DIO1 ( <a href="#">11.02 DIO delayed status</a> , bit 0).  | 10              |
|       | DIO2                        | Digital input/output DIO2 ( <a href="#">11.02 DIO delayed status</a> , bit 1).  | 11              |
|       | DIIL                        | DIIL input ( <a href="#">10.02 DI delayed status</a> , bit 15).   | 30              |
|       | <i>Other [bit]</i>          | Source selection (see <a href="#">Terms and abbreviations</a> on page 112).   | -               |



| No.   | Name/Value                   | Description  | Def/FbEq16      |
|---|------------------------------|--|-----------------|
| 20.23   | <i>Positive speed enable</i> | <p>Selects the source of the positive speed enable command.</p> <p>1 = Positive speed enabled.</p> <p>0 = Positive speed interpreted as zero speed reference. In the figure below, <i>23.01 Speed ref ramp input</i> is set to zero after the positive speed enable signal has cleared.</p> <p>Actions in different control modes:</p> <p>Speed control: Speed reference is set to zero and the motor ramps down along the currently active deceleration ramp. The drive keeps modulating. The rush controller prevents additional torque terms from running the motor in the positive direction.</p> <p>Torque control: The rush controller monitors the rotation direction of the motor.</p> | <i>Selected</i> |
| <p>The diagram illustrates the timing of four signals: 20.23 Positive speed enable, 20.24 Negative speed enable, 23.01 Speed ref ramp input, and 01.01 Motor speed used. The signals are shown as waveforms over time. 20.23 starts high and goes low. 20.24 starts high and goes low. 23.01 starts high and goes low. 01.01 starts at a positive value and ramps down to zero when 20.23 goes low. Later, 20.23 goes high, 20.24 goes high, 23.01 goes high, and 01.01 ramps up from zero.</p> |                              |  |                 |
|   | Not selected                 | 0.   | 0               |
|   | Selected                     | 1.   | 1               |
|   | DI1                          | Digital input DI1 ( <i>10.02 DI delayed status</i> , bit 0).   | 2               |
|   | DI2                          | Digital input DI2 ( <i>10.02 DI delayed status</i> , bit 1).   | 3               |
|   | DI3                          | Digital input DI3 ( <i>10.02 DI delayed status</i> , bit 2).   | 4               |
|   | DI4                          | Digital input DI4 ( <i>10.02 DI delayed status</i> , bit 3).   | 5               |
|   | DI5                          | Digital input DI5 ( <i>10.02 DI delayed status</i> , bit 4).   | 6               |
|   | DI6                          | Digital input DI6 ( <i>10.02 DI delayed status</i> , bit 5).   | 7               |
|   | DIO1                         | Digital input/output DIO1 ( <i>11.02 DIO delayed status</i> , bit 0).  | 10              |
|   | DIO2                         | Digital input/output DIO2 ( <i>11.02 DIO delayed status</i> , bit 1).  | 11              |
|   | <i>Other [bit]</i>           | Source selection (see <i>Terms and abbreviations</i> on page 112).   | -               |
| 20.24   | <i>Negative speed enable</i> | Selects the source of the negative speed reference enable command. See parameter <i>20.23 Positive speed enable</i> .  | <i>Selected</i> |

| No.   | Name/Value                    | Description  | Def/FbEq16          |
|-------|-------------------------------|--|---------------------|
| 20.25 | <i>Jogging enable</i>         | <p>Selects the source for a jog enable signal.<br/>(The sources for jogging activation signals are selected by parameters <a href="#">20.26 Jogging 1 start source</a> and <a href="#">20.27 Jogging 2 start source</a>.)</p> <p>1 = Jogging is enabled.<br/>0 = Jogging is disabled.</p> <p><b>Note:</b> Jogging can be enabled only when no start command from an external control location is active. On the other hand, if jogging is already enabled, the drive cannot be started from an external control location (apart from inching commands through fieldbus).</p> <p>See section <a href="#">Jogging</a> (page 55).</p> | <i>Not selected</i> |
|       | Not selected                  | 0.   | 0                   |
|       | Selected                      | 1.   | 1                   |
|       | DI1                           | Digital input DI1 ( <a href="#">10.02 DI delayed status</a> , bit 0).  | 2                   |
|       | DI2                           | Digital input DI2 ( <a href="#">10.02 DI delayed status</a> , bit 1).  | 3                   |
|       | DI3                           | Digital input DI3 ( <a href="#">10.02 DI delayed status</a> , bit 2).  | 4                   |
|       | DI4                           | Digital input DI4 ( <a href="#">10.02 DI delayed status</a> , bit 3).  | 5                   |
|       | DI5                           | Digital input DI5 ( <a href="#">10.02 DI delayed status</a> , bit 4).  | 6                   |
|       | DI6                           | Digital input DI6 ( <a href="#">10.02 DI delayed status</a> , bit 5).  | 7                   |
|       | DIO1                          | Digital input/output DIO1 ( <a href="#">11.02 DIO delayed status</a> , bit 0).   | 10                  |
|       | DIO2                          | Digital input/output DIO2 ( <a href="#">11.02 DIO delayed status</a> , bit 1).   | 11                  |
|       | <i>Other [bit]</i>            | Source selection (see <a href="#">Terms and abbreviations</a> on page 112).  | -                   |
| 20.26 | <i>Jogging 1 start source</i> | <p>If enabled by parameter <a href="#">20.25 Jogging enable</a>, selects the source for the activation of jogging function 1. (Jogging function 1 can also be activated through fieldbus regardless of parameter <a href="#">20.25</a>.)</p> <p>1 = Jogging 1 active.</p> <p><b>Note:</b> If both jogging 1 and 2 are activated, the one that was activated first has priority.</p>  | <i>Not selected</i> |
|       | Not selected                  | 0.   | 0                   |
|       | Selected                      | 1.   | 1                   |
|       | DI1                           | Digital input DI1 ( <a href="#">10.02 DI delayed status</a> , bit 0).  | 2                   |
|       | DI2                           | Digital input DI2 ( <a href="#">10.02 DI delayed status</a> , bit 1).  | 3                   |
|       | DI3                           | Digital input DI3 ( <a href="#">10.02 DI delayed status</a> , bit 2).  | 4                   |
|       | DI4                           | Digital input DI4 ( <a href="#">10.02 DI delayed status</a> , bit 3).  | 5                   |
|       | DI5                           | Digital input DI5 ( <a href="#">10.02 DI delayed status</a> , bit 4).  | 6                   |
|       | DI6                           | Digital input DI6 ( <a href="#">10.02 DI delayed status</a> , bit 5).  | 7                   |
|       | DIO1                          | Digital input/output DIO1 ( <a href="#">11.02 DIO delayed status</a> , bit 0).   | 10                  |
|       | DIO2                          | Digital input/output DIO2 ( <a href="#">11.02 DIO delayed status</a> , bit 1).   | 11                  |
|       | <i>Other [bit]</i>            | Source selection (see <a href="#">Terms and abbreviations</a> on page 112).  | -                   |

| No.  | Name/Value                             | Description   | Def/FbEq16          |     |      |         |   |              |   |   |              |                                |        |          |  |
|--|--|---|---------------------|-----|------|---------|---|--------------|---|---|--------------|--------------------------------|--------|----------|--|
| 20.27  | <i>Jogging 2 start source</i>          | If enabled by parameter <i>20.25 Jogging enable</i> , selects the source for the activation of jogging function 2. (Jogging function 2 can also be activated through fieldbus regardless of parameter <i>20.25</i> .)<br>1 = Jogging 2 active.<br>For the selections, see parameter <i>20.26 Jogging 1 start source</i> .<br><b>Note:</b> If both jogging 1 and 2 are activated, the one that was activated first has priority.   | <i>Not selected</i> |     |      |         |   |              |   |   |              |                                |        |          |  |
| 20.29  | <i>Local start trigger type</i>        | Defines whether the start signal for local control (for example, control panel or PC tool) is edge-triggered or level-triggered.  | <i>Edge</i>         |     |      |         |   |              |   |   |              |                                |        |          |  |
|  | Edge                                   | The start signal is edge-triggered.   | 0                   |     |      |         |   |              |   |   |              |                                |        |          |  |
|  | Level                                  | The start signal is level-triggered.  | 1                   |     |      |         |   |              |   |   |              |                                |        |          |  |
| 20.30  | <i>Enable signals warning function</i> | Selects enable signal (eg. run enable, start enable) warnings to be suppressed. This parameter can be used to prevent these warnings from flooding the event log.<br>Whenever a bit of this parameter is set to 1, the corresponding warning is suppressed, ie. no warning is generated even if the signal is switched off.<br>The bits of this binary number correspond to the following warnings:   | 00b                 |     |      |         |   |              |   |   |              |                                |        |          |  |
| <table border="1"> <thead> <tr> <th>Bit</th> <th>Name</th> <th>Warning</th> </tr> </thead> <tbody> <tr> <td>0</td> <td>Enable Start</td> <td><i>AFEA Enable start signal missing</i></td> </tr> <tr> <td>1</td> <td>Run enable 1</td> <td><i>AFEF Run enable missing</i></td> </tr> <tr> <td>2...15</td> <td>Reserved</td> <td></td> </tr> </tbody> </table> |  |   |                     | Bit | Name | Warning | 0 | Enable Start | <i>AFEA Enable start signal missing</i> | 1 | Run enable 1 | <i>AFEF Run enable missing</i> | 2...15 | Reserved |  |
| Bit  | Name                                   | Warning   |                     |     |      |         |   |              |   |   |              |                                |        |          |  |
| 0  | Enable Start                           | <i>AFEA Enable start signal missing</i>   |                     |     |      |         |   |              |   |   |              |                                |        |          |  |
| 1  | Run enable 1                           | <i>AFEF Run enable missing</i>  |                     |     |      |         |   |              |   |   |              |                                |        |          |  |
| 2...15   | Reserved                               |   |                     |     |      |         |   |              |   |   |              |                                |        |          |  |
|  | 00b...11b                              | Suppression of "enable signal missing" warnings.  | 1 = 1               |     |      |         |   |              |   |   |              |                                |        |          |  |
| <b>21 Start/stop mode</b>  |  | Start and stop modes; emergency stop mode and signal source selection; DC magnetization settings; autophasing mode selection.   |                     |     |      |         |   |              |   |   |              |                                |        |          |  |
| 21.01  | <i>Start mode</i>                      | Selects the motor start function for the DTC motor control mode, ie. when <i>99.04 Motor control mode</i> is set to <i>DTC</i> .<br><b>Notes:</b> <ul style="list-style-type: none"> <li>The start function for the scalar motor control mode is selected by parameter <i>21.19 Scalar start mode</i>.</li> <li>Starting into a rotating motor is not possible when DC magnetizing is selected (<i>Fast</i> or <i>Constant time</i>).</li> <li>With permanent magnet motors and synchronous reluctance motors, <i>Automatic</i> start mode must be used.</li> <li>This parameter cannot be changed while the drive is running.</li> </ul> See also section <i>DC magnetization</i> (page 63). | <i>Automatic</i>    |     |      |         |   |              |   |   |              |                                |        |          |  |
|  | Fast                                   | The drive pre-magnetizes the motor before start. The pre-magnetizing time is determined automatically, being typically 200 ms to 2 s depending on motor size. This mode should be selected if a high break-away torque is required.   | 0                   |     |      |         |   |              |   |   |              |                                |        |          |  |

| No.                   | Name/Value                         | Description   | Def/FbEq16            |                           |        |                |            |                 |              |                  |                |                   |        |
|-----------------------|------------------------------------|---|-----------------------|---------------------------|--------|----------------|------------|-----------------|--------------|------------------|----------------|-------------------|--------|
|                       | Constant time                      | <p>The drive pre-magnetizes the motor before start. The pre-magnetizing time is defined by parameter <a href="#">21.02 Magnetization time</a>. This mode should be selected if constant pre-magnetizing time is required (e.g. if the motor start must be synchronized with the release of a mechanical brake). This setting also guarantees the highest possible break-away torque when the pre-magnetizing time is set long enough.</p> <p> <b>WARNING!</b> The drive will start after the set magnetizing time has passed even if motor magnetization is not completed. In applications where a full break-away torque is essential, ensure that the constant magnetizing time is long enough to allow generation of full magnetization and torque.</p>   | 1                     |                           |        |                |            |                 |              |                  |                |                   |        |
|                       | Automatic                          | Automatic start guarantees optimal motor start in most cases. It includes the flying start function (starting into a rotating motor) and the automatic restart function (a stopped motor can be restarted immediately without waiting the motor flux to die away). The drive motor control program identifies the flux as well as the mechanical state of the motor and starts the motor instantly under all conditions.  | 2                     |                           |        |                |            |                 |              |                  |                |                   |        |
|                       | Flying start                       | This method is intended for asynchronous motors only, and is optimized for applications where the drive must be started into a rotating motor at high frequencies (above 150 Hz).   | 3                     |                           |        |                |            |                 |              |                  |                |                   |        |
| <a href="#">21.02</a> | <a href="#">Magnetization time</a> | <p>Defines the pre-magnetization time when</p> <ul style="list-style-type: none"> <li>parameter <a href="#">21.01 Start mode</a> is set to <a href="#">Constant time</a> (in DTC motor control mode), or</li> <li>parameter <a href="#">21.19 Scalar start mode</a> is set to <a href="#">Const time</a> (in scalar motor control mode).</li> </ul> <p>After the start command, the drive automatically premagnetizes the motor for the set time. To ensure full magnetizing, set this parameter to the same value as, or higher than, the rotor time constant. If not known, use the rule-of-thumb value given in the table below:</p> <table border="1" data-bbox="478 1323 1188 1568"> <thead> <tr> <th>Motor rated power</th> <th>Constant magnetizing time</th> </tr> </thead> <tbody> <tr> <td>&lt; 1 kW</td> <td>≥ 50 to 100 ms</td> </tr> <tr> <td>1 to 10 kW</td> <td>≥ 100 to 200 ms</td> </tr> <tr> <td>10 to 200 kW</td> <td>≥ 200 to 1000 ms</td> </tr> <tr> <td>200 to 1000 kW</td> <td>≥ 1000 to 2000 ms</td> </tr> </tbody> </table> <p><b>Note:</b> This parameter cannot be changed while the drive is running.</p> | Motor rated power     | Constant magnetizing time | < 1 kW | ≥ 50 to 100 ms | 1 to 10 kW | ≥ 100 to 200 ms | 10 to 200 kW | ≥ 200 to 1000 ms | 200 to 1000 kW | ≥ 1000 to 2000 ms | 500 ms |
| Motor rated power     | Constant magnetizing time          |   |                       |                           |        |                |            |                 |              |                  |                |                   |        |
| < 1 kW                | ≥ 50 to 100 ms                     |   |                       |                           |        |                |            |                 |              |                  |                |                   |        |
| 1 to 10 kW            | ≥ 100 to 200 ms                    |   |                       |                           |        |                |            |                 |              |                  |                |                   |        |
| 10 to 200 kW          | ≥ 200 to 1000 ms                   |   |                       |                           |        |                |            |                 |              |                  |                |                   |        |
| 200 to 1000 kW        | ≥ 1000 to 2000 ms                  |   |                       |                           |        |                |            |                 |              |                  |                |                   |        |
|                       | 0 ... 10000 ms                     | Constant DC magnetizing time.   | 1 = 1 ms              |                           |        |                |            |                 |              |                  |                |                   |        |
| <a href="#">21.03</a> | <a href="#">Stop mode</a>          | <p>Selects the way the motor is stopped when a stop command is received.</p> <p>Additional braking is possible by selecting flux braking (see parameter <a href="#">97.05 Flux braking</a>).</p> <p><b>Note:</b> This parameter has no effect in a follower drive in a master/follower configuration.</p>   | <a href="#">Coast</a> |                           |        |                |            |                 |              |                  |                |                   |        |
|                       | Coast                              | <p>Stop by switching off the output semiconductors of the drive. The motor coasts to a stop.</p> <p> <b>WARNING!</b> If a mechanical brake is used, ensure it is safe to stop the drive by coasting.</p>   | 0                     |                           |        |                |            |                 |              |                  |                |                   |        |

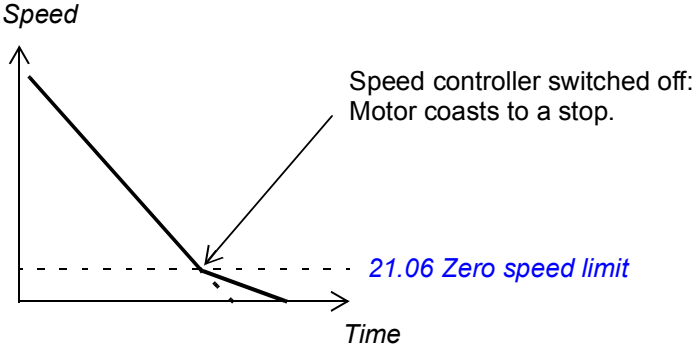
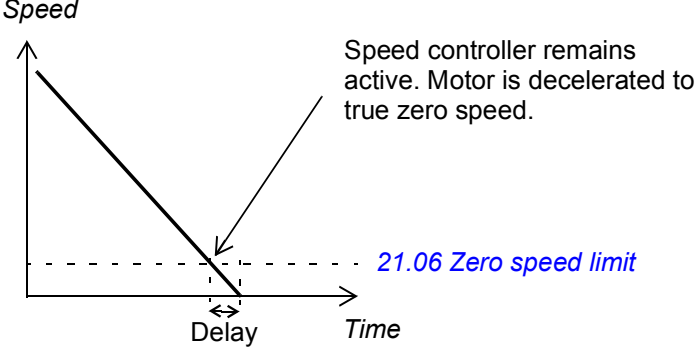

| No.                   | Name/Value                            | Description  | Def/FbEq16   |
|-----------------------|---------------------------------------|--|--|
|                       | Ramp                                  | Stop along the active deceleration ramp. See parameter group <a href="#">23 Speed reference ramp</a> on page <a href="#">218</a> .   | 1  |
|                       | Torque limit                          | Stop according to torque limits (parameters <a href="#">30.19</a> and <a href="#">30.20</a> ).   | 2  |
| <a href="#">21.04</a> | <a href="#">Emergency stop mode</a>   | Selects the way the motor is stopped when an emergency stop command is received.<br>The source of the emergency stop signal is selected by parameter <a href="#">21.05 Emergency stop source</a> .   | <a href="#">Ramp stop (Off1)</a> ; <a href="#">Coast stop (Off2)</a> ( <a href="#">95.20</a> b1); <a href="#">Eme ramp stop (Off3)</a> ( <a href="#">95.20</a> b2) |
|                       | Ramp stop (Off1)                      | With the drive running: <ul style="list-style-type: none"> <li>• 1 = Normal operation.</li> <li>• 0 = Normal stop along the standard deceleration ramp defined for the particular reference type (see section <a href="#">Reference ramping</a> [page <a href="#">42</a>]). After the drive has stopped, it can be restarted by removing the emergency stop signal and switching the start signal from 0 to 1.</li> </ul> With the drive stopped: <ul style="list-style-type: none"> <li>• 1 = Starting allowed.</li> <li>• 0 = Starting not allowed.</li> </ul> | 0  |
|                       | Coast stop (Off2)                     | With the drive running: <ul style="list-style-type: none"> <li>• 1 = Normal operation.</li> <li>• 0 = Stop by coasting. The drive can be restarted by restoring the start interlock signal and switching the start signal from 0 to 1.</li> </ul> With the drive stopped: <ul style="list-style-type: none"> <li>• 1 = Starting allowed.</li> <li>• 0 = Starting not allowed.</li> </ul>   | 1  |
|                       | Eme ramp stop (Off3)                  | With the drive running: <ul style="list-style-type: none"> <li>• 1 = Normal operation.</li> <li>• 0 = Stop by ramping along emergency stop ramp defined by parameter <a href="#">23.23 Emergency stop time</a>. After the drive has stopped, it can be restarted by removing the emergency stop signal and switching the start signal from 0 to 1.</li> </ul> With the drive stopped: <ul style="list-style-type: none"> <li>• 1 = Starting allowed.</li> <li>• 0 = Starting not allowed.</li> </ul>   | 2  |
| <a href="#">21.05</a> | <a href="#">Emergency stop source</a> | Selects the source of the emergency stop signal. The stop mode is selected by parameter <a href="#">21.04 Emergency stop mode</a> .<br>0 = Emergency stop active<br>1 = Normal operation<br><b>Note:</b> This parameter cannot be changed while the drive is running.  | <a href="#">Inactive (true)</a> ; <a href="#">D14</a> ( <a href="#">95.20</a> b1, <a href="#">95.20</a> b2)  |
|                       | Active (false)                        | 0.   | 0  |
|                       | Inactive (true)                       | 1.   | 1  |
|                       | DIIL                                  | DIIL input ( <a href="#">10.02 DI delayed status</a> , bit 15).  | 2  |
|                       | DI1                                   | Digital input DI1 ( <a href="#">10.02 DI delayed status</a> , bit 0).  | 3  |
|                       | DI2                                   | Digital input DI2 ( <a href="#">10.02 DI delayed status</a> , bit 1).  | 4  |
|                       | DI3                                   | Digital input DI3 ( <a href="#">10.02 DI delayed status</a> , bit 2).  | 5  |
|                       | DI4                                   | Digital input DI4 ( <a href="#">10.02 DI delayed status</a> , bit 3).  | 6  |
|                       | DI5                                   | Digital input DI5 ( <a href="#">10.02 DI delayed status</a> , bit 4).  | 7  |

| No.   | Name/Value              | Description   | Def/FbEq16                     |
|-------|-------------------------|---|--------------------------------|
|       | DI6                     | Digital input DI6 ( <a href="#">10.02 DI delayed status</a> , bit 5).   | 8                              |
|       | DIO1                    | Digital input/output DIO1 ( <a href="#">11.02 DIO delayed status</a> , bit 0).  | 11                             |
|       | DIO2                    | Digital input/output DIO2 ( <a href="#">11.02 DIO delayed status</a> , bit 1).  | 12                             |
|       | <i>Other [bit]</i>      | Source selection (see <a href="#">Terms and abbreviations</a> on page 112).   | -                              |
| 21.06 | <i>Zero speed limit</i> | Defines the zero speed limit. The motor is stopped along a speed ramp (when ramped stop is selected) until the defined zero speed limit is reached. After the zero speed delay, the motor coasts to a stop.   | 30.00 rpm                      |
|       | 0.00 ... 30000.00 rpm   | Zero speed limit.   | See par. <a href="#">46.01</a> |
| 21.07 | <i>Zero speed delay</i> | <p>Defines the delay for the zero speed delay function. The function is useful in applications where a smooth and quick restarting is essential. During the delay, the drive knows the rotor position accurately.</p> <p><u>Without zero speed delay:</u><br/>The drive receives a stop command and decelerates along a ramp. When actual motor speed falls below the value of parameter <a href="#">21.06 Zero speed limit</a>, inverter modulation is stopped and the motor coasts to a standstill.</p>  <p><u>With zero speed delay:</u><br/>The drive receives a stop command and decelerates along a ramp. When actual motor speed falls below the value of parameter <a href="#">21.06 Zero speed limit</a>, the zero speed delay function activates. During the delay the function keeps the speed controller live: the inverter modulates, motor is magnetized and the drive is ready for a quick restart. Zero speed delay can be used e.g. with the jogging function.</p>  | 0 ms                           |
|       | 0 ... 30000 ms          | Zero speed delay.   | 1 = 1 ms                       |

| No.   | Name/Value   | Description  | Def/FbEq16            |     |       |   |   |   |  |        |          |
|---|--|--|-----------------------|-----|-------|---|---|---|--|--------|----------|
| 21.08   | <i>DC current control</i>  | <p>Activates/deactivates the DC hold and post-magnetization functions. See section <i>DC magnetization</i> (page 63).</p> <p><b>Notes:</b></p> <ul style="list-style-type: none"> <li>• These functions are only available in speed control in DTC motor control mode (see page 22).</li> <li>• DC magnetization causes the motor to heat up. In applications where long DC magnetization times are required, externally ventilated motors should be used. If the DC magnetization period is long, DC magnetization cannot prevent the motor shaft from rotating if a constant load is applied to the motor.</li> </ul>  | 0000b                 |     |       |   |   |   |  |        |          |
| <table border="1"> <thead> <tr> <th>Bit</th> <th>Value</th> </tr> </thead> <tbody> <tr> <td>0</td> <td>1 = Enable DC hold. See section <i>DC hold</i> (page 63).<br/><b>Note:</b> The DC hold function has no effect if the start signal is switched off.</td> </tr> <tr> <td>1</td> <td>1 = Enable post-magnetization. See section <i>Post-magnetization</i> (page 64).<br/><b>Note:</b> Post-magnetization is only available when ramping is the selected stop mode (see parameter <i>21.03 Stop mode</i>).</td> </tr> <tr> <td>2...15</td> <td>Reserved</td> </tr> </tbody> </table> |  |  |                       | Bit | Value | 0 | 1 = Enable DC hold. See section <i>DC hold</i> (page 63).<br><b>Note:</b> The DC hold function has no effect if the start signal is switched off. | 1 | 1 = Enable post-magnetization. See section <i>Post-magnetization</i> (page 64).<br><b>Note:</b> Post-magnetization is only available when ramping is the selected stop mode (see parameter <i>21.03 Stop mode</i> ). | 2...15 | Reserved |
| Bit   | Value  |  |                       |     |       |   |   |   |  |        |          |
| 0   | 1 = Enable DC hold. See section <i>DC hold</i> (page 63).<br><b>Note:</b> The DC hold function has no effect if the start signal is switched off.  |  |                       |     |       |   |   |   |  |        |          |
| 1   | 1 = Enable post-magnetization. See section <i>Post-magnetization</i> (page 64).<br><b>Note:</b> Post-magnetization is only available when ramping is the selected stop mode (see parameter <i>21.03 Stop mode</i> ). |  |                       |     |       |   |   |   |  |        |          |
| 2...15  | Reserved   |  |                       |     |       |   |   |   |  |        |          |
|   | 0000b...0011b  | DC magnetization selection.  | 1 = 1                 |     |       |   |   |   |  |        |          |
| 21.09   | <i>DC hold speed</i>   | Defines the DC hold speed. See parameter <i>21.08 DC current control</i> , and section <i>DC hold</i> (page 63).   | 5.00 rpm              |     |       |   |   |   |  |        |          |
|   | 0.00 ... 1000.00 rpm   | DC hold speed.   | See par. <i>46.01</i> |     |       |   |   |   |  |        |          |
| 21.10   | <i>DC current reference</i>  | Defines the DC hold current in percent of the motor nominal current. See parameter <i>21.08 DC current control</i> , and section <i>DC magnetization</i> (page 63).  | 30.0%                 |     |       |   |   |   |  |        |          |
|   | 0.0 ... 100.0%   | DC hold current.   | 1 = 1%                |     |       |   |   |   |  |        |          |
| 21.11   | <i>Post magnetization time</i>   | Defines the length of time for which post-magnetization is active after stopping the motor. The magnetization current is defined by parameter <i>21.10 DC current reference</i> . See parameter <i>21.08 DC current control</i> .  | 0 s                   |     |       |   |   |   |  |        |          |
|   | 0...3000 s   | Post-magnetization time.   | 1 = 1 s               |     |       |   |   |   |  |        |          |
| 21.12   | <i>Continuous magnetization command</i>  | <p>Activates/deactivates (or selects a source that activates/deactivates) continuous magnetization. See section <i>Continuous magnetization</i> (page 64).</p> <p>The magnetization current is calculated on the basis of flux reference (see parameter group <i>97 Motor control</i>).</p> <p><b>Notes:</b></p> <ul style="list-style-type: none"> <li>• This function is only available when ramping is the selected stop mode (see parameter <i>21.03 Stop mode</i>), and only in speed control in DTC motor control mode (see page 22).</li> <li>• Continuous magnetization causes the motor to heat up. In applications where long magnetization times are required, externally ventilated motors should be used.</li> <li>• Continuous magnetization may not be able to prevent the motor shaft from rotating during a long period if a constant load is applied to the motor.</li> </ul> <p>0 = Normal operation<br/>1 = Magnetization active</p> | <i>Off</i>            |     |       |   |   |   |  |        |          |
|   | Off  | 0.   | 0                     |     |       |   |   |   |  |        |          |
|   | On   | 1.   | 1                     |     |       |   |   |   |  |        |          |

| No.   | Name/Value                      | Description   | Def/FbEq16     |
|-------|---------------------------------|---|----------------|
|       | <i>Other [bit]</i>              | Source selection (see <i>Terms and abbreviations</i> on page 112).  | -              |
| 21.13 | <i>Autophasing mode</i>         | Selects the way autophasing is performed. See section <i>Autophasing</i> on page 59.  | <i>Turning</i> |
|       | Turning                         | This mode gives the most accurate autophasing result. This mode can be used, and is recommended, if the motor is allowed to rotate and the start-up is not time-critical.<br><b>Note:</b> This mode will cause the motor to rotate. The load torque must be less than 5%.   | 0              |
|       | Standstill 1                    | Faster than the <i>Turning</i> mode, but not as accurate. The motor will not rotate.  | 1              |
|       | Standstill 2                    | An alternative standstill autophasing mode that can be used if the <i>Turning</i> mode cannot be used, and the <i>Standstill 1</i> mode gives erratic results. However, this mode is considerably slower than <i>Standstill 1</i> .   | 2              |
|       | Turning with Z-pulse            | This mode should be used if the zero pulse signal of the pulse encoder is to be observed, and other modes do not give a result. The motor will turn until a zero pulse is detected.   | 3              |
| 21.14 | <i>Pre-heating input source</i> | Selects the source of the motor pre-heat on/off command. See section <i>Pre-heating</i> (page 63).<br><b>Note:</b> The pre-heating function will not activate if <ul style="list-style-type: none"> <li>the Safe torque off function is active,</li> <li>a fault is active,</li> <li>less than one minute has elapsed after stopping, or</li> <li>PID sleep function is active.</li> </ul> Pre-heating is deactivated when the drive is started, and overridden by pre-magnetization, post-magnetization or continuous magnetization.<br>0 = Pre-heating inactive<br>1 = Pre-heating active | <i>Off</i>     |
|       | Off                             | 0. Pre-heating is always deactivated.   | 0              |
|       | On                              | 1. Pre-heating is always activated when the drive is stopped (apart from conditions stated above).  | 1              |
|       | DI1                             | Digital input DI1 ( <i>10.02 DI delayed status</i> , bit 0).  | 2              |
|       | DI2                             | Digital input DI2 ( <i>10.02 DI delayed status</i> , bit 1).  | 3              |
|       | DI3                             | Digital input DI3 ( <i>10.02 DI delayed status</i> , bit 2).  | 4              |
|       | DI4                             | Digital input DI4 ( <i>10.02 DI delayed status</i> , bit 3).  | 5              |
|       | DI5                             | Digital input DI5 ( <i>10.02 DI delayed status</i> , bit 4).  | 6              |
|       | DI6                             | Digital input DI6 ( <i>10.02 DI delayed status</i> , bit 5).  | 7              |
|       | Supervision 1                   | Supervision 1 active ( <i>32.01 Supervision status</i> , bit 0).  | 8              |
|       | Supervision 2                   | Supervision 2 active ( <i>32.01 Supervision status</i> , bit 1).  | 9              |
|       | Supervision 3                   | Supervision 3 active ( <i>32.01 Supervision status</i> , bit 2).  | 10             |
|       | <i>Other [bit]</i>              | Source selection (see <i>Terms and abbreviations</i> on page 112).  | -              |
| 21.16 | <i>Pre-heating current</i>      | Defines the motor pre-heating current that is fed into the motor when the source selected by <i>21.14 Pre-heating input source</i> is on. The value is in percent of the nominal motor current.   | 0.0%           |
|       | 0.0 ... 30.0%                   | Pre-heating current.  | 1 = 1%         |



| No.   | Name/Value                      | Description  | Def/FbEq16          |
|-------|---------------------------------|--|---------------------|
| 21.18 | <i>Auto restart time</i>        | <p>The motor can be automatically started after a short supply power failure using the automatic restart function. See section <a href="#">Automatic restart</a> (page 76).</p> <p>When this parameter is set to 0.0 seconds, automatic restarting is disabled. Otherwise, the parameter defines the maximum duration of the power failure after which restarting is attempted. Note that this time also includes the DC pre-charging delay.</p> <p> <b>WARNING!</b> The function restarts the drive automatically and continues operation after a supply break. Make sure that no dangerous situations can occur.</p>  | 5.0 s               |
|       | 0.0 s                           | Automatic restarting disabled.   | 0                   |
|       | 0.1 ... 5.0 s                   | Maximum power failure duration.  | 1 = 1 s             |
| 21.19 | <i>Scalar start mode</i>        | <p>Selects the motor start function for the scalar motor control mode, ie. when <a href="#">99.04 Motor control mode</a> is set to <i>Scalar</i>.</p> <p><b>Notes:</b></p> <ul style="list-style-type: none"> <li>• The start function for the DTC motor control mode is selected by parameter <a href="#">21.01 Start mode</a>.</li> <li>• With permanent magnet motors, <i>Automatic</i> start mode must be used.</li> <li>• This parameter cannot be changed while the drive is running.</li> </ul> <p>See also section <a href="#">DC magnetization</a> (page 63).</p>   | <i>Normal</i>       |
|       | Normal                          | Immediate start from zero speed.   | 0                   |
|       | Const time                      | <p>The drive pre-magnetizes the motor before start. The pre-magnetizing time is defined by parameter <a href="#">21.02 Magnetization time</a>. This mode should be selected if constant pre-magnetizing time is required (e.g. if the motor start must be synchronized with the release of a mechanical brake). This setting also guarantees the highest possible break-away torque when the pre-magnetizing time is set long enough.</p> <p><b>Note:</b> This mode cannot be used to start into a rotating motor.</p> <p> <b>WARNING!</b> The drive will start after the set magnetizing time has passed even if motor magnetization is not completed. In applications where a full break-away torque is essential, ensure that the constant magnetizing time is long enough to allow generation of full magnetization and torque.</p> | 1                   |
|       | Automatic                       | This setting should be used in applications where flying starts (ie. starting into a rotating motor) are required.   | 2                   |
| 21.20 | <i>Follower force ramp stop</i> | <p>In a torque-controlled follower drive, forces (or selects a source that forces) the drive to switch to speed control upon a ramp stop (Off1 or Off3) command. This is required for an independent ramp stop of the follower.</p> <p>See also section <a href="#">Master/follower functionality</a> (page 31).</p> <p>1 = Ramp stop forces speed control</p>   | <i>Not selected</i> |
|       | Not selected                    | 0.   | 0                   |
|       | Selected                        | 1.   | 1                   |
|       | DIIL                            | DIIL input ( <a href="#">10.02 DI delayed status</a> , bit 15).  | 2                   |
|       | DI1                             | Digital input DI1 ( <a href="#">10.02 DI delayed status</a> , bit 0).  | 3                   |
|       | DI2                             | Digital input DI2 ( <a href="#">10.02 DI delayed status</a> , bit 1).  | 4                   |
|       | DI3                             | Digital input DI3 ( <a href="#">10.02 DI delayed status</a> , bit 2).  | 5                   |

| No. | Name/Value         | Description  | Def/FbEq16 |
|-----|--------------------|--|------------|
|     | DI4                | Digital input DI4 ( <a href="#">10.02 DI delayed status</a> , bit 3).          | 6          |
|     | DI5                | Digital input DI5 ( <a href="#">10.02 DI delayed status</a> , bit 4).          | 7          |
|     | DI6                | Digital input DI6 ( <a href="#">10.02 DI delayed status</a> , bit 5).          | 8          |
|     | DIO1               | Digital input/output DIO1 ( <a href="#">11.02 DIO delayed status</a> , bit 0). | 11         |
|     | DIO2               | Digital input/output DIO2 ( <a href="#">11.02 DIO delayed status</a> , bit 1). | 12         |
|     | <i>Other [bit]</i> | Source selection (see <a href="#">Terms and abbreviations</a> on page 112).    | -          |

|                                     |   |  |
|-------------------------------------|---|--|
| <b>22 Speed reference selection</b> | Speed reference selection; motor potentiometer settings. See the control chain diagrams on pages 564...566. |  |
|-------------------------------------|---|--|

|   |   |   |
|---|---|---|
| <a href="#">22.01 Speed ref unlimited</a> | Displays the output of the speed reference selection block. See the control chain diagram on page 565. This parameter is read-only. | - |
|---|---|---|

|                               |  |                                |
|-------------------------------|--|--------------------------------|
| -30000.00 ...<br>30000.00 rpm | Value of the selected speed reference. | See par. <a href="#">46.01</a> |
|-------------------------------|--|--------------------------------|

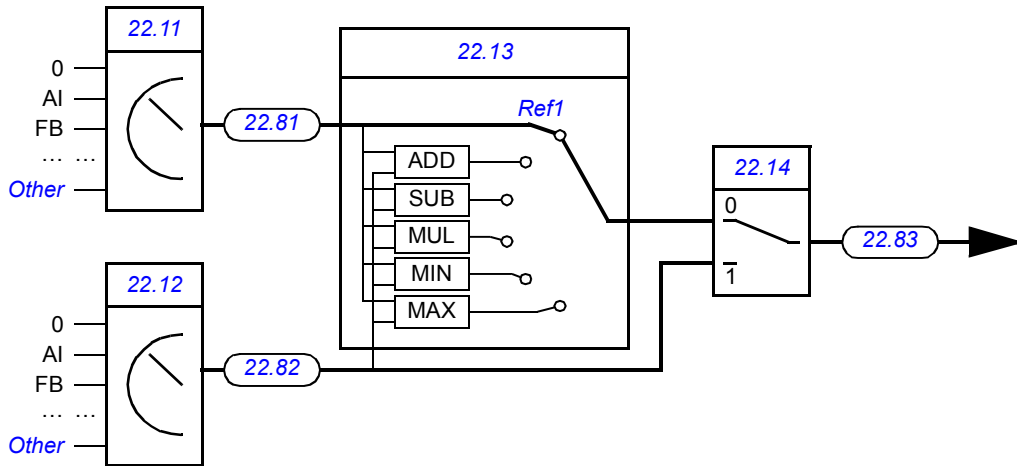

|   |  |                            |
|---|--|----------------------------|
| <a href="#">22.11 Speed ref1 source</a> | <p>Selects speed reference source 1.</p> <p>Two signal sources can be defined by this parameter and <a href="#">22.12 Speed ref2 source</a>. A digital source selected by <a href="#">22.14 Speed ref1/2 selection</a> can be used to switch between the two sources, or a mathematical function (<a href="#">22.13 Speed ref1 function</a>) applied to the two signals to create the reference.</p> | <a href="#">AI1 scaled</a> |
|---|--|----------------------------|



|                     |  |    |
|---------------------|--|----|
| Zero                | None.  | 0  |
| AI1 scaled          | <a href="#">12.12 AI1 scaled value</a> (see page 158).                                 | 1  |
| AI2 scaled          | <a href="#">12.22 AI2 scaled value</a> (see page 160).                                 | 2  |
| FB A ref1           | <a href="#">03.05 FB A reference 1</a> (see page 119).                                 | 4  |
| FB A ref2           | <a href="#">03.06 FB A reference 2</a> (see page 120).                                 | 5  |
| EFB ref1            | <a href="#">03.09 EFB reference 1</a> (see page 120).                                  | 8  |
| EFB ref2            | <a href="#">03.10 EFB reference 2</a> (see page 120).                                  | 9  |
| DDCS ctrl ref1      | <a href="#">03.11 DDCS controller ref 1</a> (see page 120).                            | 10 |
| DDCS ctrl ref2      | <a href="#">03.12 DDCS controller ref 2</a> (see page 120).                            | 11 |
| M/F reference 1     | <a href="#">03.13 M/F or D2D ref1</a> (see page 120).                                  | 12 |
| M/F reference 2     | <a href="#">03.14 M/F or D2D ref2</a> (see page 120).                                  | 13 |
| Motor potentiometer | <a href="#">22.80 Motor potentiometer ref act</a> (output of the motor potentiometer). | 15 |

| No.                   | Name/Value                             | Description   | Def/FbEq16                        |
|-----------------------|--|---|-----------------------------------|
|                       | PID                                    | <a href="#">40.01 Process PID output actual</a> (output of the process PID controller).   | 16                                |
|                       | Control panel (ref saved)              | Control panel reference, with initial value from last-used panel reference. See section <a href="#">Using the control panel as an external control source</a> (page 21).  | 18                                |
|                       | Control panel (ref copied)             | Control panel reference, with initial value from previous source or actual value. See section <a href="#">Using the control panel as an external control source</a> (page 21).  | 19                                |
|                       | <i>Other</i>                           | Source selection (see <a href="#">Terms and abbreviations</a> on page 112).   | -                                 |
| <a href="#">22.12</a> | <a href="#">Speed ref2 source</a>      | Selects speed reference source 2.<br>For the selections, and a diagram of reference source selection, see parameter <a href="#">22.11 Speed ref1 source</a> .   | <i>Zero</i>                       |
| <a href="#">22.13</a> | <a href="#">Speed ref1 function</a>    | Selects a mathematical function between the reference sources selected by parameters <a href="#">22.11 Speed ref1 source</a> and <a href="#">22.12 Speed ref2 source</a> . See diagram at <a href="#">22.11 Speed ref1 source</a> . | <i>Ref1</i>                       |
|                       | Ref1                                   | Signal selected by <a href="#">22.11 Speed ref1 source</a> is used as speed reference 1 as such (no function applied).  | 0                                 |
|                       | Add (ref1 + ref2)                      | The sum of the reference sources is used as speed reference 1.  | 1                                 |
|                       | Sub (ref1 - ref2)                      | The subtraction ( <a href="#">[22.11 Speed ref1 source]</a> - <a href="#">[22.12 Speed ref2 source]</a> ) of the reference sources is used as speed reference 1.  | 2                                 |
|                       | Mul (ref1 × ref2)                      | The multiplication of the reference sources is used as speed reference 1.   | 3                                 |
|                       | Min (ref1, ref2)                       | The smaller of the reference sources is used as speed reference 1.  | 4                                 |
|                       | Max (ref1, ref2)                       | The greater of the reference sources is used as speed reference 1.  | 5                                 |
| <a href="#">22.14</a> | <a href="#">Speed ref1/2 selection</a> | Configures the selection between speed references 1 and 2. See diagram at <a href="#">22.11 Speed ref1 source</a> .<br>0 = Speed reference 1<br>1 = Speed reference 2   | <i>Follow Ext1/Ext2 selection</i> |
|                       | Speed reference 1                      | 0.  | 0                                 |
|                       | Speed reference 2                      | 1.  | 1                                 |
|                       | Follow Ext1/Ext2 selection             | Speed reference 1 is used when external control location EXT1 is active. Speed reference 2 is used when external control location EXT2 is active.<br>See also parameter <a href="#">19.11 Ext1/Ext2 selection</a> .                 | 2                                 |
|                       | DI1                                    | Digital input DI1 ( <a href="#">10.02 DI delayed status</a> , bit 0).   | 3                                 |
|                       | DI2                                    | Digital input DI2 ( <a href="#">10.02 DI delayed status</a> , bit 1).   | 4                                 |
|                       | DI3                                    | Digital input DI3 ( <a href="#">10.02 DI delayed status</a> , bit 2).   | 5                                 |
|                       | DI4                                    | Digital input DI4 ( <a href="#">10.02 DI delayed status</a> , bit 3).   | 6                                 |
|                       | DI5                                    | Digital input DI5 ( <a href="#">10.02 DI delayed status</a> , bit 4).   | 7                                 |
|                       | DI6                                    | Digital input DI6 ( <a href="#">10.02 DI delayed status</a> , bit 5).   | 8                                 |
|                       | DIO1                                   | Digital input/output DIO1 ( <a href="#">11.02 DIO delayed status</a> , bit 0).  | 11                                |
|                       | DIO2                                   | Digital input/output DIO2 ( <a href="#">11.02 DIO delayed status</a> , bit 1).  | 12                                |
|                       | <i>Other [bit]</i>                     | Source selection (see <a href="#">Terms and abbreviations</a> on page 112).   | -                                 |

## 212 Parameters

| No.  | Name/Value                     | Description   | Def/FbEq16 |     |      |             |   |                     |  |  |   |                  |   |   |        |          |  |
|--|--------------------------------|---|------------|-----|------|-------------|---|---------------------|--|--|---|------------------|---|---|--------|----------|--|
| 22.15  | <i>Speed additive 1 source</i> | Defines a reference to be added to the speed reference after reference selection (see page 564).<br>For the selections, see parameter <a href="#">22.11 Speed ref1 source</a> .<br><b>Note:</b> For safety reasons, the additive is not applied when any of the stop functions are active.  | Zero       |     |      |             |   |                     |  |  |   |                  |   |   |        |          |  |
| 22.16  | <i>Speed share</i>             | Defines a scaling factor for the selected speed reference (speed reference 1 or 2, multiplied by the defined value).<br>Speed reference 1 or 2 is selected by parameter <a href="#">22.14 Speed ref1/2 selection</a> .  | 1.000      |     |      |             |   |                     |  |  |   |                  |   |   |        |          |  |
|  | -8.000 ...8.000                | Speed reference scaling factor.   | 1000 = 1   |     |      |             |   |                     |  |  |   |                  |   |   |        |          |  |
| 22.17  | <i>Speed additive 2 source</i> | Defines a reference to be added to the speed reference after the speed share function (see page 564).<br>For the selections, see parameter <a href="#">22.11 Speed ref1 source</a> .<br><b>Note:</b> For safety reasons, the additive is not applied when any of the stop functions are active.   | Zero       |     |      |             |   |                     |  |  |   |                  |   |   |        |          |  |
| 22.21  | <i>Constant speed function</i> | Determines how constant speeds are selected, and whether the rotation direction signal is considered or not when applying a constant speed.   | 0000b      |     |      |             |   |                     |  |  |   |                  |   |   |        |          |  |
| <table border="1"> <thead> <tr> <th>Bit</th> <th>Name</th> <th>Information</th> </tr> </thead> <tbody> <tr> <td rowspan="2">0</td> <td rowspan="2">Constant speed mode</td> <td>1 = Packed: 7 constant speeds are selectable using the three sources defined by parameters <a href="#">22.22</a>, <a href="#">22.23</a> and <a href="#">22.24</a>.</td> </tr> <tr> <td>0 = Separate: Constant speeds 1, 2 and 3 are separately activated by the sources defined by parameters <a href="#">22.22</a>, <a href="#">22.23</a> and <a href="#">22.24</a> respectively. In case of conflict, the constant speed with the smaller number takes priority.</td> </tr> <tr> <td rowspan="2">1</td> <td rowspan="2">Direction enable</td> <td>1 = Start dir: To determine running direction for a constant speed, the sign of the constant speed setting (parameters <a href="#">22.26...22.32</a>) is multiplied by the direction signal (forward: +1, reverse: -1). This effectively allows the drive to have 14 (7 forward, 7 reverse) constant speeds if all values in <a href="#">22.26...22.32</a> are positive.<br/> <b>WARNING:</b> If the direction signal is reverse and the active constant speed is negative, the drive will run in the forward direction.</td> </tr> <tr> <td>0 = Accord Par: The running direction for the constant speed is determined by the sign of the constant speed setting (parameters <a href="#">22.26...22.32</a>).</td> </tr> <tr> <td>2...15</td> <td>Reserved</td> <td></td> </tr> </tbody> </table> |                                |   |            | Bit | Name | Information | 0 | Constant speed mode | 1 = Packed: 7 constant speeds are selectable using the three sources defined by parameters <a href="#">22.22</a> , <a href="#">22.23</a> and <a href="#">22.24</a> . | 0 = Separate: Constant speeds 1, 2 and 3 are separately activated by the sources defined by parameters <a href="#">22.22</a> , <a href="#">22.23</a> and <a href="#">22.24</a> respectively. In case of conflict, the constant speed with the smaller number takes priority. | 1 | Direction enable | 1 = Start dir: To determine running direction for a constant speed, the sign of the constant speed setting (parameters <a href="#">22.26...22.32</a> ) is multiplied by the direction signal (forward: +1, reverse: -1). This effectively allows the drive to have 14 (7 forward, 7 reverse) constant speeds if all values in <a href="#">22.26...22.32</a> are positive.<br> <b>WARNING:</b> If the direction signal is reverse and the active constant speed is negative, the drive will run in the forward direction. | 0 = Accord Par: The running direction for the constant speed is determined by the sign of the constant speed setting (parameters <a href="#">22.26...22.32</a> ). | 2...15 | Reserved |  |
| Bit  | Name                           | Information   |            |     |      |             |   |                     |  |  |   |                  |   |   |        |          |  |
| 0  | Constant speed mode            | 1 = Packed: 7 constant speeds are selectable using the three sources defined by parameters <a href="#">22.22</a> , <a href="#">22.23</a> and <a href="#">22.24</a> .  |            |     |      |             |   |                     |  |  |   |                  |   |   |        |          |  |
|  |                                | 0 = Separate: Constant speeds 1, 2 and 3 are separately activated by the sources defined by parameters <a href="#">22.22</a> , <a href="#">22.23</a> and <a href="#">22.24</a> respectively. In case of conflict, the constant speed with the smaller number takes priority.  |            |     |      |             |   |                     |  |  |   |                  |   |   |        |          |  |
| 1  | Direction enable               | 1 = Start dir: To determine running direction for a constant speed, the sign of the constant speed setting (parameters <a href="#">22.26...22.32</a> ) is multiplied by the direction signal (forward: +1, reverse: -1). This effectively allows the drive to have 14 (7 forward, 7 reverse) constant speeds if all values in <a href="#">22.26...22.32</a> are positive.<br> <b>WARNING:</b> If the direction signal is reverse and the active constant speed is negative, the drive will run in the forward direction. |            |     |      |             |   |                     |  |  |   |                  |   |   |        |          |  |
|  |                                | 0 = Accord Par: The running direction for the constant speed is determined by the sign of the constant speed setting (parameters <a href="#">22.26...22.32</a> ).   |            |     |      |             |   |                     |  |  |   |                  |   |   |        |          |  |
| 2...15   | Reserved                       |   |            |     |      |             |   |                     |  |  |   |                  |   |   |        |          |  |
| 0000b...0011b  |                                | Constant speed configuration word.  | 1 = 1      |     |      |             |   |                     |  |  |   |                  |   |   |        |          |  |

| No.   | Name/Value                                   | Description  | Def/FbEq16                     |  |  |  |                       |   |   |   |      |   |   |   |                  |   |   |   |                  |   |   |   |                  |   |   |   |                  |   |   |   |                  |   |   |   |                  |   |   |   |                  |
|---|--|--|--------------------------------|--|--|--|-----------------------|---|---|---|------|---|---|---|------------------|---|---|---|------------------|---|---|---|------------------|---|---|---|------------------|---|---|---|------------------|---|---|---|------------------|---|---|---|------------------|
| 22.22   | <a href="#">Constant speed sel1</a>          | When bit 0 of parameter <a href="#">22.21 Constant speed function</a> is 0 (Separate), selects a source that activates constant speed 1. When bit 0 of parameter <a href="#">22.21 Constant speed function</a> is 1 (Packed), this parameter and parameters <a href="#">22.23 Constant speed sel2</a> and <a href="#">22.24 Constant speed sel3</a> select three sources whose states activate constant speeds as follows:   | <a href="#">DI5</a>            |  |  |  |                       |   |   |   |      |   |   |   |                  |   |   |   |                  |   |   |   |                  |   |   |   |                  |   |   |   |                  |   |   |   |                  |   |   |   |                  |
| <table border="1"> <thead> <tr> <th>Source defined by par. <a href="#">22.22</a></th> <th>Source defined by par. <a href="#">22.23</a></th> <th>Source defined by par. <a href="#">22.24</a></th> <th>Constant speed active</th> </tr> </thead> <tbody> <tr> <td>0</td> <td>0</td> <td>0</td> <td>None</td> </tr> <tr> <td>1</td> <td>0</td> <td>0</td> <td>Constant speed 1</td> </tr> <tr> <td>0</td> <td>1</td> <td>0</td> <td>Constant speed 2</td> </tr> <tr> <td>1</td> <td>1</td> <td>0</td> <td>Constant speed 3</td> </tr> <tr> <td>0</td> <td>0</td> <td>1</td> <td>Constant speed 4</td> </tr> <tr> <td>1</td> <td>0</td> <td>1</td> <td>Constant speed 5</td> </tr> <tr> <td>0</td> <td>1</td> <td>1</td> <td>Constant speed 6</td> </tr> <tr> <td>1</td> <td>1</td> <td>1</td> <td>Constant speed 7</td> </tr> </tbody> </table> |  |  |                                | Source defined by par. <a href="#">22.22</a> | Source defined by par. <a href="#">22.23</a> | Source defined by par. <a href="#">22.24</a> | Constant speed active | 0 | 0 | 0 | None | 1 | 0 | 0 | Constant speed 1 | 0 | 1 | 0 | Constant speed 2 | 1 | 1 | 0 | Constant speed 3 | 0 | 0 | 1 | Constant speed 4 | 1 | 0 | 1 | Constant speed 5 | 0 | 1 | 1 | Constant speed 6 | 1 | 1 | 1 | Constant speed 7 |
| Source defined by par. <a href="#">22.22</a>  | Source defined by par. <a href="#">22.23</a> | Source defined by par. <a href="#">22.24</a>   | Constant speed active          |  |  |  |                       |   |   |   |      |   |   |   |                  |   |   |   |                  |   |   |   |                  |   |   |   |                  |   |   |   |                  |   |   |   |                  |   |   |   |                  |
| 0   | 0  | 0  | None                           |  |  |  |                       |   |   |   |      |   |   |   |                  |   |   |   |                  |   |   |   |                  |   |   |   |                  |   |   |   |                  |   |   |   |                  |   |   |   |                  |
| 1   | 0  | 0  | Constant speed 1               |  |  |  |                       |   |   |   |      |   |   |   |                  |   |   |   |                  |   |   |   |                  |   |   |   |                  |   |   |   |                  |   |   |   |                  |   |   |   |                  |
| 0   | 1  | 0  | Constant speed 2               |  |  |  |                       |   |   |   |      |   |   |   |                  |   |   |   |                  |   |   |   |                  |   |   |   |                  |   |   |   |                  |   |   |   |                  |   |   |   |                  |
| 1   | 1  | 0  | Constant speed 3               |  |  |  |                       |   |   |   |      |   |   |   |                  |   |   |   |                  |   |   |   |                  |   |   |   |                  |   |   |   |                  |   |   |   |                  |   |   |   |                  |
| 0   | 0  | 1  | Constant speed 4               |  |  |  |                       |   |   |   |      |   |   |   |                  |   |   |   |                  |   |   |   |                  |   |   |   |                  |   |   |   |                  |   |   |   |                  |   |   |   |                  |
| 1   | 0  | 1  | Constant speed 5               |  |  |  |                       |   |   |   |      |   |   |   |                  |   |   |   |                  |   |   |   |                  |   |   |   |                  |   |   |   |                  |   |   |   |                  |   |   |   |                  |
| 0   | 1  | 1  | Constant speed 6               |  |  |  |                       |   |   |   |      |   |   |   |                  |   |   |   |                  |   |   |   |                  |   |   |   |                  |   |   |   |                  |   |   |   |                  |   |   |   |                  |
| 1   | 1  | 1  | Constant speed 7               |  |  |  |                       |   |   |   |      |   |   |   |                  |   |   |   |                  |   |   |   |                  |   |   |   |                  |   |   |   |                  |   |   |   |                  |   |   |   |                  |
|   | Not selected                                 | 0 (always off).  | 0                              |  |  |  |                       |   |   |   |      |   |   |   |                  |   |   |   |                  |   |   |   |                  |   |   |   |                  |   |   |   |                  |   |   |   |                  |   |   |   |                  |
|   | Selected                                     | 1 (always on).   | 1                              |  |  |  |                       |   |   |   |      |   |   |   |                  |   |   |   |                  |   |   |   |                  |   |   |   |                  |   |   |   |                  |   |   |   |                  |   |   |   |                  |
|   | DI1  | Digital input DI1 ( <a href="#">10.02 DI delayed status</a> , bit 0).  | 2                              |  |  |  |                       |   |   |   |      |   |   |   |                  |   |   |   |                  |   |   |   |                  |   |   |   |                  |   |   |   |                  |   |   |   |                  |   |   |   |                  |
|   | DI2  | Digital input DI2 ( <a href="#">10.02 DI delayed status</a> , bit 1).  | 3                              |  |  |  |                       |   |   |   |      |   |   |   |                  |   |   |   |                  |   |   |   |                  |   |   |   |                  |   |   |   |                  |   |   |   |                  |   |   |   |                  |
|   | DI3  | Digital input DI3 ( <a href="#">10.02 DI delayed status</a> , bit 2).  | 4                              |  |  |  |                       |   |   |   |      |   |   |   |                  |   |   |   |                  |   |   |   |                  |   |   |   |                  |   |   |   |                  |   |   |   |                  |   |   |   |                  |
|   | DI4  | Digital input DI4 ( <a href="#">10.02 DI delayed status</a> , bit 3).  | 5                              |  |  |  |                       |   |   |   |      |   |   |   |                  |   |   |   |                  |   |   |   |                  |   |   |   |                  |   |   |   |                  |   |   |   |                  |   |   |   |                  |
|   | DI5  | Digital input DI5 ( <a href="#">10.02 DI delayed status</a> , bit 4).  | 6                              |  |  |  |                       |   |   |   |      |   |   |   |                  |   |   |   |                  |   |   |   |                  |   |   |   |                  |   |   |   |                  |   |   |   |                  |   |   |   |                  |
|   | DI6  | Digital input DI6 ( <a href="#">10.02 DI delayed status</a> , bit 5).  | 7                              |  |  |  |                       |   |   |   |      |   |   |   |                  |   |   |   |                  |   |   |   |                  |   |   |   |                  |   |   |   |                  |   |   |   |                  |   |   |   |                  |
|   | DIO1   | Digital input/output DIO1 ( <a href="#">11.02 DIO delayed status</a> , bit 0).   | 10                             |  |  |  |                       |   |   |   |      |   |   |   |                  |   |   |   |                  |   |   |   |                  |   |   |   |                  |   |   |   |                  |   |   |   |                  |   |   |   |                  |
|   | DIO2   | Digital input/output DIO2 ( <a href="#">11.02 DIO delayed status</a> , bit 1).   | 11                             |  |  |  |                       |   |   |   |      |   |   |   |                  |   |   |   |                  |   |   |   |                  |   |   |   |                  |   |   |   |                  |   |   |   |                  |   |   |   |                  |
|   | <a href="#">Other [bit]</a>                  | Source selection (see <a href="#">Terms and abbreviations</a> on page 112).  | -                              |  |  |  |                       |   |   |   |      |   |   |   |                  |   |   |   |                  |   |   |   |                  |   |   |   |                  |   |   |   |                  |   |   |   |                  |   |   |   |                  |
| 22.23   | <a href="#">Constant speed sel2</a>          | When bit 0 of parameter <a href="#">22.21 Constant speed function</a> is 0 (Separate), selects a source that activates constant speed 2. When bit 0 of parameter <a href="#">22.21 Constant speed function</a> is 1 (Packed), this parameter and parameters <a href="#">22.22 Constant speed sel1</a> and <a href="#">22.24 Constant speed sel3</a> select three sources that are used to activate constant speeds. See table at parameter <a href="#">22.22 Constant speed sel1</a> . For the selections, see parameter <a href="#">22.22 Constant speed sel1</a> . | <a href="#">Not selected</a>   |  |  |  |                       |   |   |   |      |   |   |   |                  |   |   |   |                  |   |   |   |                  |   |   |   |                  |   |   |   |                  |   |   |   |                  |   |   |   |                  |
| 22.24   | <a href="#">Constant speed sel3</a>          | When bit 0 of parameter <a href="#">22.21 Constant speed function</a> is 0 (Separate), selects a source that activates constant speed 3. When bit 0 of parameter <a href="#">22.21 Constant speed function</a> is 1 (Packed), this parameter and parameters <a href="#">22.22 Constant speed sel1</a> and <a href="#">22.23 Constant speed sel2</a> select three sources that are used to activate constant speeds. See table at parameter <a href="#">22.22 Constant speed sel1</a> . For the selections, see parameter <a href="#">22.22 Constant speed sel1</a> . | <a href="#">Not selected</a>   |  |  |  |                       |   |   |   |      |   |   |   |                  |   |   |   |                  |   |   |   |                  |   |   |   |                  |   |   |   |                  |   |   |   |                  |   |   |   |                  |
| 22.26   | <a href="#">Constant speed 1</a>             | Defines constant speed 1 (the speed the motor will turn when constant speed 1 is selected).  | 300.00 rpm                     |  |  |  |                       |   |   |   |      |   |   |   |                  |   |   |   |                  |   |   |   |                  |   |   |   |                  |   |   |   |                  |   |   |   |                  |   |   |   |                  |
|   | -30000.00 ...<br>30000.00 rpm                | Constant speed 1.  | See par. <a href="#">46.01</a> |  |  |  |                       |   |   |   |      |   |   |   |                  |   |   |   |                  |   |   |   |                  |   |   |   |                  |   |   |   |                  |   |   |   |                  |   |   |   |                  |

## 214 Parameters

| No.   | Name/Value                    | Description   | Def/FbEq16                        |
|-------|-------------------------------|---|-----------------------------------|
| 22.27 | <i>Constant speed 2</i>       | Defines constant speed 2.   | 0.00 rpm                          |
|       | -30000.00 ...<br>30000.00 rpm | Constant speed 2.   | See par.<br><a href="#">46.01</a> |
| 22.28 | <i>Constant speed 3</i>       | Defines constant speed 3.   | 0.00 rpm                          |
|       | -30000.00 ...<br>30000.00 rpm | Constant speed 3.   | See par.<br><a href="#">46.01</a> |
| 22.29 | <i>Constant speed 4</i>       | Defines constant speed 4.   | 0.00 rpm                          |
|       | -30000.00 ...<br>30000.00 rpm | Constant speed 4.   | See par.<br><a href="#">46.01</a> |
| 22.30 | <i>Constant speed 5</i>       | Defines constant speed 5.   | 0.00 rpm                          |
|       | -30000.00 ...<br>30000.00 rpm | Constant speed 5.   | See par.<br><a href="#">46.01</a> |
| 22.31 | <i>Constant speed 6</i>       | Defines constant speed 6.   | 0.00 rpm                          |
|       | -30000.00 ...<br>30000.00 rpm | Constant speed 6.   | See par.<br><a href="#">46.01</a> |
| 22.32 | <i>Constant speed 7</i>       | Defines constant speed 7.   | 0.00 rpm                          |
|       | -30000.00 ...<br>30000.00 rpm | Constant speed 7.   | See par.<br><a href="#">46.01</a> |
| 22.41 | <i>Speed ref safe</i>         | Defines a safe speed reference value that is used with supervision functions such as <ul style="list-style-type: none"> <li>• <a href="#">12.03 AI supervision function</a></li> <li>• <a href="#">49.05 Communication loss action</a></li> <li>• <a href="#">50.02 FBA A comm loss func</a></li> <li>• <a href="#">50.32 FBA B comm loss func</a></li> <li>• <a href="#">58.14 Communication loss action.</a></li> </ul> | 0.00 rpm                          |
|       | -30000.00 ...<br>30000.00 rpm | Safe speed reference.   | See par.<br><a href="#">46.01</a> |
| 22.42 | <i>Jogging 1 ref</i>          | Defines the speed reference for jogging function 1. For more information on jogging, see page <a href="#">55</a> .  | 0.00 rpm                          |
|       | -30000.00 ...<br>30000.00 rpm | Speed reference for jogging function 1.   | See par.<br><a href="#">46.01</a> |
| 22.43 | <i>Jogging 2 ref</i>          | Defines the speed reference for jogging function 2. For more information on jogging, see page <a href="#">55</a> .  | 0.00 rpm                          |
|       | -30000.00 ...<br>30000.00 rpm | Speed reference for jogging function 2.   | See par.<br><a href="#">46.01</a> |

| No.   | Name/Value                          | Description   | Def/FbEq16            |     |      |             |   |        |                                      |  |   |           |   |  |        |          |  |
|---|-------------------------------------|---|-----------------------|-----|------|-------------|---|--------|--------------------------------------|--|---|-----------|---|--|--------|----------|--|
| 22.51   | <i>Critical speed function</i>      | Enables/disables the critical speeds function. Also determines whether the specified ranges are effective in both rotating directions or not.<br>See also section <i>Critical speeds/frequencies</i> (page 43). | 0000b                 |     |      |             |   |        |                                      |  |   |           |   |  |        |          |  |
| <table border="1"> <thead> <tr> <th>Bit</th> <th>Name</th> <th>Information</th> </tr> </thead> <tbody> <tr> <td rowspan="2">0</td> <td rowspan="2">Enable</td> <td>1 = Enable: Critical speeds enabled.</td> </tr> <tr> <td>0 = Disable: Critical speeds disabled.</td> </tr> <tr> <td rowspan="2">1</td> <td rowspan="2">Sign mode</td> <td>1 = Signed: The signs of parameters 22.52...22.57 are taken into account.</td> </tr> <tr> <td>0 = Absolute: Parameters 22.52...22.57 are handled as absolute values. Each range is effective in both directions of rotation.</td> </tr> <tr> <td>2...15</td> <td>Reserved</td> <td></td> </tr> </tbody> </table> |                                     |   |                       | Bit | Name | Information | 0 | Enable | 1 = Enable: Critical speeds enabled. | 0 = Disable: Critical speeds disabled. | 1 | Sign mode | 1 = Signed: The signs of parameters 22.52...22.57 are taken into account. | 0 = Absolute: Parameters 22.52...22.57 are handled as absolute values. Each range is effective in both directions of rotation. | 2...15 | Reserved |  |
| Bit   | Name                                | Information   |                       |     |      |             |   |        |                                      |  |   |           |   |  |        |          |  |
| 0   | Enable                              | 1 = Enable: Critical speeds enabled.  |                       |     |      |             |   |        |                                      |  |   |           |   |  |        |          |  |
|   |                                     | 0 = Disable: Critical speeds disabled.  |                       |     |      |             |   |        |                                      |  |   |           |   |  |        |          |  |
| 1   | Sign mode                           | 1 = Signed: The signs of parameters 22.52...22.57 are taken into account.   |                       |     |      |             |   |        |                                      |  |   |           |   |  |        |          |  |
|   |                                     | 0 = Absolute: Parameters 22.52...22.57 are handled as absolute values. Each range is effective in both directions of rotation.  |                       |     |      |             |   |        |                                      |  |   |           |   |  |        |          |  |
| 2...15  | Reserved                            |   |                       |     |      |             |   |        |                                      |  |   |           |   |  |        |          |  |
|   | 0000b...0011b                       | Critical speeds configuration word.   | 1 = 1                 |     |      |             |   |        |                                      |  |   |           |   |  |        |          |  |
| 22.52   | <i>Critical speed 1 low</i>         | Defines the low limit for critical speed range 1.<br><b>Note:</b> This value must be less than or equal to the value of <i>22.53 Critical speed 1 high</i> .  | 0.00 rpm              |     |      |             |   |        |                                      |  |   |           |   |  |        |          |  |
|   | -30000.00 ...<br>30000.00 rpm       | Low limit for critical speed 1.   | See par. <i>46.01</i> |     |      |             |   |        |                                      |  |   |           |   |  |        |          |  |
| 22.53   | <i>Critical speed 1 high</i>        | Defines the high limit for critical speed range 1.<br><b>Note:</b> This value must be greater than or equal to the value of <i>22.52 Critical speed 1 low</i> .   | 0.00 rpm              |     |      |             |   |        |                                      |  |   |           |   |  |        |          |  |
|   | -30000.00 ...<br>30000.00 rpm       | High limit for critical speed 1.  | See par. <i>46.01</i> |     |      |             |   |        |                                      |  |   |           |   |  |        |          |  |
| 22.54   | <i>Critical speed 2 low</i>         | Defines the low limit for critical speed range 2.<br><b>Note:</b> This value must be less than or equal to the value of <i>22.55 Critical speed 2 high</i> .  | 0.00 rpm              |     |      |             |   |        |                                      |  |   |           |   |  |        |          |  |
|   | -30000.00 ...<br>30000.00 rpm       | Low limit for critical speed 2.   | See par. <i>46.01</i> |     |      |             |   |        |                                      |  |   |           |   |  |        |          |  |
| 22.55   | <i>Critical speed 2 high</i>        | Defines the high limit for critical speed range 2.<br><b>Note:</b> This value must be greater than or equal to the value of <i>22.54 Critical speed 2 low</i> .   | 0.00 rpm              |     |      |             |   |        |                                      |  |   |           |   |  |        |          |  |
|   | -30000.00 ...<br>30000.00 rpm       | High limit for critical speed 2.  | See par. <i>46.01</i> |     |      |             |   |        |                                      |  |   |           |   |  |        |          |  |
| 22.56   | <i>Critical speed 3 low</i>         | Defines the low limit for critical speed range 3.<br><b>Note:</b> This value must be less than or equal to the value of <i>22.57 Critical speed 3 high</i> .  | 0.00 rpm              |     |      |             |   |        |                                      |  |   |           |   |  |        |          |  |
|   | -30000.00 ...<br>30000.00 rpm       | Low limit for critical speed 3.   | See par. <i>46.01</i> |     |      |             |   |        |                                      |  |   |           |   |  |        |          |  |
| 22.57   | <i>Critical speed 3 high</i>        | Defines the high limit for critical speed range 3.<br><b>Note:</b> This value must be greater than or equal to the value of <i>22.56 Critical speed 3 low</i> .   | 0.00 rpm              |     |      |             |   |        |                                      |  |   |           |   |  |        |          |  |
|   | -30000.00 ...<br>30000.00 rpm       | High limit for critical speed 3.  | See par. <i>46.01</i> |     |      |             |   |        |                                      |  |   |           |   |  |        |          |  |
| 22.71   | <i>Motor potentiometer function</i> | Activates and selects the mode of the motor potentiometer.<br>See section <i>Motor potentiometer</i> (page 69).   | <i>Disabled</i>       |     |      |             |   |        |                                      |  |   |           |   |  |        |          |  |
|   | Disabled                            | Motor potentiometer is disabled and its value set to 0.   | 0                     |     |      |             |   |        |                                      |  |   |           |   |  |        |          |  |



| No.                   | Name/Value  | Description   | Def/FbEq16          |
|-----------------------|---|---|---------------------|
|                       | Enabled (init at stop/power-up)                   | When enabled, the motor potentiometer first adopts the value defined by parameter <a href="#">22.72 Motor potentiometer initial value</a> . When the drive is running, the value can be adjusted from the up and down sources defined by parameters <a href="#">22.73 Motor potentiometer up source</a> and <a href="#">22.74 Motor potentiometer down source</a> .<br>A stop or a power cycle will reset the motor potentiometer to the initial value ( <a href="#">22.72</a> ). | 1                   |
|                       | Enabled (resume always)                           | As <a href="#">Enabled (init at stop/power-up)</a> , but the motor potentiometer value is retained over a stop or a power cycle.  | 2                   |
| <a href="#">22.72</a> | <a href="#">Motor potentiometer initial value</a> | Defines an initial value (starting point) for the motor potentiometer. See the selections of parameter <a href="#">22.71 Motor potentiometer function</a> .   | 0.00                |
|                       | -32768.00 ...<br>32767.00                         | Initial value for motor potentiometer.  | 1 = 1               |
| <a href="#">22.73</a> | <a href="#">Motor potentiometer up source</a>     | Selects the source of motor potentiometer up signal.<br>0 = No change<br>1 = Increase motor potentiometer value. (If both the up and down sources are on, the potentiometer value will not change.)   | <i>Not selected</i> |
|                       | Not selected                                      | 0.  | 0                   |
|                       | Selected  | 1.  | 1                   |
|                       | DI1   | Digital input DI1 ( <a href="#">10.02 DI delayed status</a> , bit 0).   | 2                   |
|                       | DI2   | Digital input DI2 ( <a href="#">10.02 DI delayed status</a> , bit 1).   | 3                   |
|                       | DI3   | Digital input DI3 ( <a href="#">10.02 DI delayed status</a> , bit 2).   | 4                   |
|                       | DI4   | Digital input DI4 ( <a href="#">10.02 DI delayed status</a> , bit 3).   | 5                   |
|                       | DI5   | Digital input DI5 ( <a href="#">10.02 DI delayed status</a> , bit 4).   | 6                   |
|                       | DI6   | Digital input DI6 ( <a href="#">10.02 DI delayed status</a> , bit 5).   | 7                   |
|                       | DIO1  | Digital input/output DIO1 ( <a href="#">11.02 DIO delayed status</a> , bit 0).  | 10                  |
|                       | DIO2  | Digital input/output DIO2 ( <a href="#">11.02 DIO delayed status</a> , bit 1).  | 11                  |
|                       | <i>Other [bit]</i>                                | Source selection (see <a href="#">Terms and abbreviations</a> on page <a href="#">112</a> ).  | -                   |
| <a href="#">22.74</a> | <a href="#">Motor potentiometer down source</a>   | Selects the source of motor potentiometer down signal.<br>0 = No change<br>1 = Decrease motor potentiometer value. (If both the up and down sources are on, the potentiometer value will not change.)<br>For the selections, see parameter <a href="#">22.73 Motor potentiometer up source</a> .  | <i>Not selected</i> |
| <a href="#">22.75</a> | <a href="#">Motor potentiometer ramp time</a>     | Defines the change rate of the motor potentiometer. This parameter specifies the time required for the motor potentiometer to change from minimum ( <a href="#">22.76</a> ) to maximum ( <a href="#">22.77</a> ). The same change rate applies in both directions.  | 60.0 s              |
|                       | 0.0 ... 3600.0 s                                  | Motor potentiometer change time.  | 10 = 1 s            |
| <a href="#">22.76</a> | <a href="#">Motor potentiometer min value</a>     | Defines the minimum value of the motor potentiometer.   | -1500.00            |
|                       | -32768.00 ...<br>32767.00                         | Motor potentiometer minimum.  | 1 = 1               |



| No.   | Name/Value                           | Description  | Def/FbEq16                     |
|-------|--------------------------------------|--|--------------------------------|
| 22.77 | <i>Motor potentiometer max value</i> | Defines the maximum value of the motor potentiometer.  | 1500.00                        |
|       | -32768.00 ...<br>32767.00            | Motor potentiometer maximum.   | 1 = 1                          |
| 22.80 | <i>Motor potentiometer ref act</i>   | Displays the output of the motor potentiometer function. (The motor potentiometer is configured using parameters <a href="#">22.71...22.74.</a> )<br>This parameter is read-only.  | -                              |
|       | -32768.00 ...<br>32767.00            | Value of motor potentiometer.  | 1 = 1                          |
| 22.81 | <i>Speed reference act 1</i>         | Displays the value of speed reference source 1 (selected by parameter <a href="#">22.11 Speed ref1 source</a> ). See the control chain diagram on page <a href="#">564</a> .<br>This parameter is read-only.   | -                              |
|       | -30000.00 ...<br>30000.00 rpm        | Value of reference source 1.   | See par. <a href="#">46.01</a> |
| 22.82 | <i>Speed reference act 2</i>         | Displays the value of speed reference source 2 (selected by parameter <a href="#">22.12 Speed ref2 source</a> ). See the control chain diagram on page <a href="#">564</a> .<br>This parameter is read-only.   | -                              |
|       | -30000.00 ...<br>30000.00 rpm        | Value of reference source 2.   | See par. <a href="#">46.01</a> |
| 22.83 | <i>Speed reference act 3</i>         | Displays the value of speed reference after the mathematical function applied by parameter <a href="#">22.13 Speed ref1 function</a> and reference 1/2 selection ( <a href="#">22.14 Speed ref1/2 selection</a> ). See the control chain diagram on page <a href="#">564</a> .<br>This parameter is read-only. | -                              |
|       | -30000.00 ...<br>30000.00 rpm        | Speed reference after source selection.  | See par. <a href="#">46.01</a> |
| 22.84 | <i>Speed reference act 4</i>         | Displays the value of speed reference after application of 1st speed additive ( <a href="#">22.15 Speed additive 1 source</a> ). See the control chain diagram on page <a href="#">564</a> .<br>This parameter is read-only.   | -                              |
|       | -30000.00 ...<br>30000.00 rpm        | Speed reference after additive 1.  | See par. <a href="#">46.01</a> |
| 22.85 | <i>Speed reference act 5</i>         | Displays the value of speed reference after the application of the speed share scaling factor ( <a href="#">22.16 Speed share</a> ). See the control chain diagram on page <a href="#">564</a> .<br>This parameter is read-only.   | -                              |
|       | -30000.00 ...<br>30000.00 rpm        | Speed reference after speed share scaling.   | See par. <a href="#">46.01</a> |
| 22.86 | <i>Speed reference act 6</i>         | Displays the value of speed reference after application of 2nd speed additive ( <a href="#">22.17 Speed additive 2 source</a> ). See the control chain diagram on page <a href="#">564</a> .<br>This parameter is read-only.   | -                              |
|       | -30000.00 ...<br>30000.00 rpm        | Speed reference after additive 2.  | See par. <a href="#">46.01</a> |

| No.                            | Name/Value                            | Description  | Def/FbEq16                                     |
|--------------------------------|---------------------------------------|--|--|
| 22.87                          | <a href="#">Speed reference act 7</a> | Displays the value of speed reference before application of critical speeds. See the control chain diagram on page 565.<br>The value is received from <a href="#">22.86 Speed reference act 6</a> unless overridden by <ul style="list-style-type: none"> <li>any constant speed</li> <li>a jogging reference</li> <li><a href="#">network control</a> reference</li> <li>control panel reference</li> <li>safe speed reference.</li> </ul> This parameter is read-only. | -  |
|                                | -30000.00 ...<br>30000.00 rpm         | Speed reference before application of critical speeds.   | See par. <a href="#">46.01</a>                 |
| <b>23 Speed reference ramp</b> |                                       | Speed reference ramp settings (programming of the acceleration and deceleration rates for the drive).<br>See the control chain diagram on page 566.  |  |
| 23.01                          | <a href="#">Speed ref ramp input</a>  | Displays the used speed reference (in rpm) before it enters the ramping and shaping functions. See the control chain diagram on page 566.<br>This parameter is read-only.  | -  |
|                                | -30000.00 ...<br>30000.00 rpm         | Speed reference before ramping and shaping.  | See par. <a href="#">46.01</a>                 |
| 23.02                          | <a href="#">Speed ref ramp output</a> | Displays the ramped and shaped speed reference in rpm. See the control chain diagram on page 566.<br>This parameter is read-only.  | -  |
|                                | -30000.00 ...<br>30000.00 rpm         | Speed reference after ramping and shaping.   | See par. <a href="#">46.01</a>                 |
| 23.11                          | <a href="#">Ramp set selection</a>    | Selects the source that switches between the two sets of acceleration/deceleration ramp times defined by parameters <a href="#">23.12...23.15</a> .<br>0 = Acceleration time 1 and deceleration time 1 are active<br>1 = Acceleration time 2 and deceleration time 2 are active  | <a href="#">DI4; Acc/Dec time 2 (95.20 b1)</a> |
|                                | Acc/Dec time 1                        | 0.   | 0  |
|                                | Acc/Dec time 2                        | 1.   | 1  |
|                                | DI1                                   | Digital input DI1 ( <a href="#">10.02 DI delayed status</a> , bit 0).  | 2  |
|                                | DI2                                   | Digital input DI2 ( <a href="#">10.02 DI delayed status</a> , bit 1).  | 3  |
|                                | DI3                                   | Digital input DI3 ( <a href="#">10.02 DI delayed status</a> , bit 2).  | 4  |
|                                | DI4                                   | Digital input DI4 ( <a href="#">10.02 DI delayed status</a> , bit 3).  | 5  |
|                                | DI5                                   | Digital input DI5 ( <a href="#">10.02 DI delayed status</a> , bit 4).  | 6  |
|                                | DI6                                   | Digital input DI6 ( <a href="#">10.02 DI delayed status</a> , bit 5).  | 7  |
|                                | DIO1                                  | Digital input/output DIO1 ( <a href="#">11.02 DIO delayed status</a> , bit 0).   | 10   |
|                                | DIO2                                  | Digital input/output DIO2 ( <a href="#">11.02 DIO delayed status</a> , bit 1).   | 11   |
|                                | <a href="#">Other [bit]</a>           | Source selection (see <a href="#">Terms and abbreviations</a> on page 112).  | -  |

| No.   | Name/Value                 | Description   | Def/FbEq16 |
|-------|----------------------------|---|------------|
| 23.12 | <i>Acceleration time 1</i> | <p>Defines acceleration time 1 as the time required for the speed to change from zero to the speed defined by parameter <a href="#">46.01 Speed scaling</a> (not to parameter <a href="#">30.12 Maximum speed</a>).</p> <p>If the speed reference increases faster than the set acceleration rate, the motor speed will follow the acceleration rate.</p> <p>If the speed reference increases slower than the set acceleration rate, the motor speed will follow the reference.</p> <p>If the acceleration time is set too short, the drive will automatically prolong the acceleration in order not to exceed the drive torque limits.</p>   | 20.000 s   |
|       | 0.000 ... 1800.000 s       | Acceleration time 1.  | 10 = 1 s   |
| 23.13 | <i>Deceleration time 1</i> | <p>Defines deceleration time 1 as the time required for the speed to change from the speed defined by parameter <a href="#">46.01 Speed scaling</a> (not from parameter <a href="#">30.12 Maximum speed</a>) to zero.</p> <p>If the speed reference decreases slower than the set deceleration rate, the motor speed will follow the reference.</p> <p>If the reference changes faster than the set deceleration rate, the motor speed will follow the deceleration rate.</p> <p>If the deceleration rate is set too short, the drive will automatically prolong the deceleration in order not to exceed drive torque limits (or not to exceed a safe DC link voltage). If there is any doubt about the deceleration time being too short, ensure that DC overvoltage control is on (parameter <a href="#">30.30 Overvoltage control</a>).</p> <p><b>Note:</b> If a short deceleration time is needed for a high inertia application, the drive should be equipped with braking equipment such as a brake chopper and brake resistor.</p> | 20.000 s   |
|       | 0.000 ... 1800.000 s       | Deceleration time 1.  | 10 = 1 s   |
| 23.14 | <i>Acceleration time 2</i> | Defines acceleration time 2. See parameter <a href="#">23.12 Acceleration time 1</a> .  | 60.000 s   |
|       | 0.000 ... 1800.000 s       | Acceleration time 2.  | 10 = 1 s   |
| 23.15 | <i>Deceleration time 2</i> | Defines deceleration time 2. See parameter <a href="#">23.13 Deceleration time 1</a> .  | 60.000 s   |
|       | 0.000 ... 1800.000 s       | Deceleration time 2.  | 10 = 1 s   |

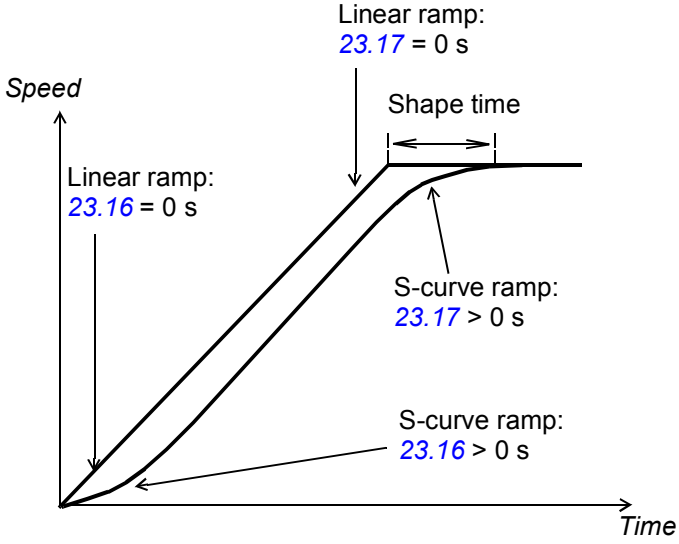
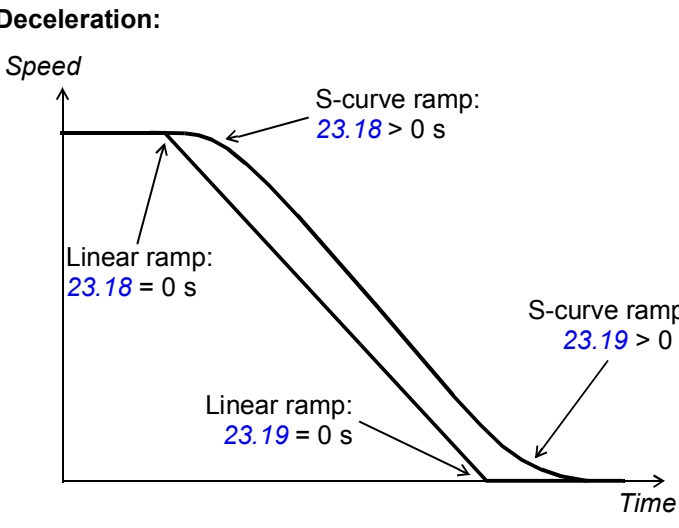
| No.   | Name/Value              | Description  | Def/FbEq16 |
|-------|-------------------------|--|------------|
| 23.16 | <i>Shape time acc 1</i> | <p>Defines the shape of the acceleration ramp at the beginning of the acceleration.</p> <p>0.000 s: Linear ramp. Suitable for steady acceleration or deceleration and for slow ramps.</p> <p>0.001...1000.000 s: S-curve ramp. S-curve ramps are ideal for lifting applications. The S-curve consists of symmetrical curves at both ends of the ramp and a linear part in between.</p> <p><b>Note:</b> For safety reasons, shape times are not applied to emergency stop ramps.</p> <p><b>Acceleration:</b></p>  <p><b>Deceleration:</b></p>  | 0.000 s    |
|       | 0.000 ...1800.000 s     | Ramp shape at start of acceleration.   | 10 = 1 s   |
| 23.17 | <i>Shape time acc 2</i> | Defines the shape of the acceleration ramp at the end of the acceleration. See parameter <a href="#">23.16 Shape time acc 1</a> .  | 0.000 s    |
|       | 0.000 ...1800.000 s     | Ramp shape at end of acceleration.   | 10 = 1 s   |
| 23.18 | <i>Shape time dec 1</i> | Defines the shape of the deceleration ramp at the beginning of the deceleration. See parameter <a href="#">23.16 Shape time acc 1</a> .  | 0.000 s    |
|       | 0.000 ...1800.000 s     | Ramp shape at start of deceleration.   | 10 = 1 s   |

| No.   | Name/Value                       | Description   | Def/FbEq16      |
|-------|----------------------------------|---|-----------------|
| 23.19 | <i>Shape time dec 2</i>          | Defines the shape of the deceleration ramp at the end of the deceleration. See parameter <i>23.16 Shape time acc 1</i> .  | 0.000 s         |
|       | 0.000 ... 1800.000 s             | Ramp shape at end of deceleration.  | 10 = 1 s        |
| 23.20 | <i>Acc time jogging</i>          | Defines the acceleration time for the jogging function i.e. the time required for the speed to change from zero to the speed value defined by parameter <i>46.01 Speed scaling</i> . See section <i>Jogging</i> (page 55).  | 60.000 s        |
|       | 0.000 ... 1800.000 s             | Acceleration time for jogging.  | 10 = 1 s        |
| 23.21 | <i>Dec time jogging</i>          | Defines the deceleration time for the jogging function i.e. the time required for the speed to change from the speed value defined by parameter <i>46.01 Speed scaling</i> to zero. See section <i>Jogging</i> (page 55).   | 60.000 s        |
|       | 0.000 ... 1800.000 s             | Deceleration time for jogging.  | 10 = 1 s        |
| 23.23 | <i>Emergency stop time</i>       | In speed control mode, this parameter defines the deceleration rate for emergency stop Off3 as the time it would take for the speed to decrease from the value of parameter <i>46.01 Speed scaling</i> to zero. This also applies to torque control because the drive switches to speed control on receiving an emergency stop Off3 command.<br>In frequency control mode, this parameter specifies the time it would take for the frequency to decrease from the value of <i>46.02 Frequency scaling</i> to zero.<br>The emergency stop mode and activation source are selected by parameters <i>21.04 Emergency stop mode</i> and <i>21.05 Emergency stop source</i> respectively. Emergency stop can also be activated through fieldbus.<br><b>Note:</b> Emergency stop Off1 uses the standard deceleration ramp as defined by parameters <i>23.11...23.19</i> (speed and torque control) or <i>28.71...28.75</i> (frequency control). | 3.000 s         |
|       | 0.000 ... 1800.000 s             | Emergency stop Off3 deceleration time.  | 10 = 1 s        |
| 23.24 | <i>Speed ramp in zero source</i> | Selects a source that forces the speed reference to zero just before it enters the ramp function.<br>0 = Force speed reference to zero before the ramp function<br>1 = Speed reference continues towards the ramp function as normal  | <i>Inactive</i> |
|       | Active                           | 0.  | 0               |
|       | Inactive                         | 1.  | 1               |
|       | DI1                              | Digital input DI1 ( <i>10.02 DI delayed status</i> , bit 0).  | 2               |
|       | DI2                              | Digital input DI2 ( <i>10.02 DI delayed status</i> , bit 1).  | 3               |
|       | DI3                              | Digital input DI3 ( <i>10.02 DI delayed status</i> , bit 2).  | 4               |
|       | DI4                              | Digital input DI4 ( <i>10.02 DI delayed status</i> , bit 3).  | 5               |
|       | DI5                              | Digital input DI5 ( <i>10.02 DI delayed status</i> , bit 4).  | 6               |
|       | DI6                              | Digital input DI6 ( <i>10.02 DI delayed status</i> , bit 5).  | 7               |
|       | DIO1                             | Digital input/output DIO1 ( <i>11.02 DIO delayed status</i> , bit 0).   | 10              |
|       | DIO2                             | Digital input/output DIO2 ( <i>11.02 DIO delayed status</i> , bit 1).   | 11              |
|       | <i>Other [bit]</i>               | Source selection (see <i>Terms and abbreviations</i> on page 112).  | -               |

## 222 Parameters

| No.   | Name/Value                                | Description   | Def/FbEq16                     |
|-------|---|---|--------------------------------|
| 23.26 | <a href="#">Ramp out balancing enable</a> | Selects the source for enabling/disabling speed reference ramp balancing.<br>This function is used to generate a smooth transfer from a torque- or tension-controlled motor back to being speed-controlled. The balancing output would be tracking the present "line" speed of the application and when transfer is required, the speed reference can then be quickly "seeded" to the correct line speed. Balancing is also possible in the speed controller, see parameter <a href="#">25.09 Speed ctrl balancing enable</a> .<br>See also parameter <a href="#">23.27 Ramp out balancing ref</a> .<br>0 = Disabled<br>1 = Enabled | <a href="#">Not selected</a>   |
|       | Not selected                              | 0.  | 0                              |
|       | Selected                                  | 1.  | 1                              |
|       | DI1                                       | Digital input DI1 ( <a href="#">10.02 DI delayed status</a> , bit 0).   | 2                              |
|       | DI2                                       | Digital input DI2 ( <a href="#">10.02 DI delayed status</a> , bit 1).   | 3                              |
|       | DI3                                       | Digital input DI3 ( <a href="#">10.02 DI delayed status</a> , bit 2).   | 4                              |
|       | DI4                                       | Digital input DI4 ( <a href="#">10.02 DI delayed status</a> , bit 3).   | 5                              |
|       | DI5                                       | Digital input DI5 ( <a href="#">10.02 DI delayed status</a> , bit 4).   | 6                              |
|       | DI6                                       | Digital input DI6 ( <a href="#">10.02 DI delayed status</a> , bit 5).   | 7                              |
|       | DIO1                                      | Digital input/output DIO1 ( <a href="#">11.02 DIO delayed status</a> , bit 0).  | 10                             |
|       | DIO2                                      | Digital input/output DIO2 ( <a href="#">11.02 DIO delayed status</a> , bit 1).  | 11                             |
|       | <a href="#">Other [bit]</a>               | Source selection (see <a href="#">Terms and abbreviations</a> on page <a href="#">112</a> ).  | -                              |
| 23.27 | <a href="#">Ramp out balancing ref</a>    | Defines the reference for speed ramp balancing. The output of the ramp generator is forced to this value when balancing is enabled by parameter <a href="#">23.26 Ramp out balancing enable</a> .   | 0.00 rpm                       |
|       | -30000.00 ...<br>30000.00 rpm             | Speed ramp balancing reference.   | See par. <a href="#">46.01</a> |

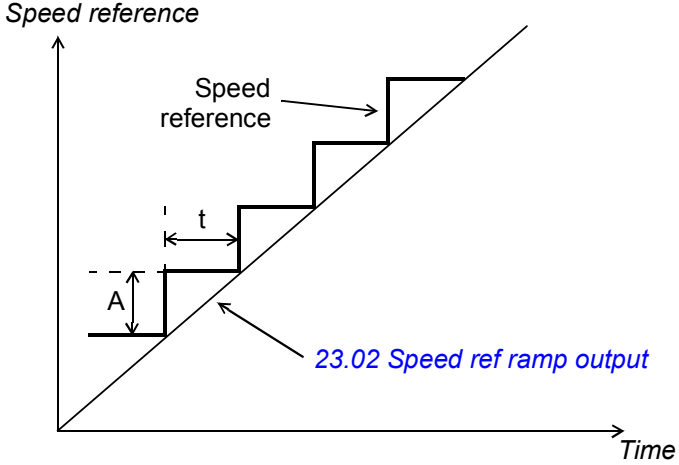
| No.   | Name/Value                              | Description   | Def/FbEq16          |
|-------|---|---|---------------------|
| 23.28 | <i>Variable slope enable</i>            | <p>Activates the variable slope function, which controls the slope of the speed ramp during a speed reference change. This allows for a constantly variable ramp rate to be generated, instead of just the standard two ramps normally available. If the update interval of the signal from an external control system and the variable slope rate (23.29 <i>Variable slope rate</i>) are equal, the resulting speed reference (23.02 <i>Speed ref ramp output</i>) is a straight line.</p>  <p><math>t</math> = update interval of signal from external control system<br/> <math>A</math> = speed reference change during <math>t</math></p> <p>This function is only active in remote control.</p> | <i>Off</i>          |
|       | Off                                     | Variable slope disabled.  | 0                   |
|       | On                                      | Variable slope enabled (not available in local control).  | 1                   |
|       | <i>Other [bit]</i>                      | Source selection (see <i>Terms and abbreviations</i> on page 112).  | -                   |
| 23.29 | <i>Variable slope rate</i>              | <p>Defines the rate of the speed reference change when variable slope is enabled by parameter 23.28 <i>Variable slope enable</i>. For the best result, enter the reference update interval into this parameter.</p>   | 50 ms               |
|       | 2...30000 ms                            | Variable slope rate.  | 1 = 1 ms            |
| 23.39 | <i>Follower speed correction out</i>    | <p>Displays the speed correction term for the load share function with a speed-controlled follower drive. See section <i>Load share function with a speed-controlled follower</i> (page 32). This parameter is read-only.</p>   | -                   |
|       | -30000.00 ... 30000.00 rpm              | Speed correction term.  | See par. 46.01      |
| 23.40 | <i>Follower speed correction enable</i> | <p>With a speed-controlled follower, selects the source for enabling/disabling the load share function. See section <i>Load share function with a speed-controlled follower</i> (page 32).<br/> 0 = Disabled<br/> 1 = Enabled</p>   | <i>Not selected</i> |
|       | Not selected                            | 0.  | 0                   |
|       | Selected                                | 1.  | 1                   |
|       | DI1                                     | Digital input DI1 ( <i>10.02 DI delayed status</i> , bit 0).  | 2                   |
|       | DI2                                     | Digital input DI2 ( <i>10.02 DI delayed status</i> , bit 1).  | 3                   |

## 224 Parameters

| No.  | Name/Value                                      | Description  | Def/FbEq16                     |
|--|---|--|--------------------------------|
|  | DI3   | Digital input DI3 ( <a href="#">10.02 DI delayed status</a> , bit 2).  | 4                              |
|  | DI4   | Digital input DI4 ( <a href="#">10.02 DI delayed status</a> , bit 3).  | 5                              |
|  | DI5   | Digital input DI5 ( <a href="#">10.02 DI delayed status</a> , bit 4).  | 6                              |
|  | DI6   | Digital input DI6 ( <a href="#">10.02 DI delayed status</a> , bit 5).  | 7                              |
|  | DIO1  | Digital input/output DIO1 ( <a href="#">11.02 DIO delayed status</a> , bit 0).   | 10                             |
|  | DIO2  | Digital input/output DIO2 ( <a href="#">11.02 DIO delayed status</a> , bit 1).   | 11                             |
|  | <i>Other [bit]</i>                              | Source selection (see <a href="#">Terms and abbreviations</a> on page 112).  | -                              |
| <a href="#">23.41</a>                                  | <a href="#">Follower speed correction gain</a>  | Adjusts the gain of the speed correction term in a speed-controlled follower. In effect, defines how accurately the follower follows the master torque. A greater value results in a more accurate performance.<br>See section <a href="#">Load share function with a speed-controlled follower</a> (page 32). | 1.00%                          |
|  | 0.00 ... 100.00%                                | Speed correction term adjustment.  | 1 = 1%                         |
| <a href="#">23.42</a>                                  | <a href="#">Follower speed corr torq source</a> | Selects the source of the torque reference for the load share function. See section <a href="#">Load share function with a speed-controlled follower</a> (page 32).  | <a href="#">MF ref 2</a>       |
|  | NULL  | None.  | 0                              |
|  | MF ref 2  | <a href="#">03.14 M/F or D2D ref2</a> (page 120).  | 1                              |
|  | <i>Other</i>                                    | Source selection (see <a href="#">Terms and abbreviations</a> on page 112).  | -                              |
| <b><a href="#">24 Speed reference conditioning</a></b> |   | Speed error calculation; speed error window control configuration; speed error step.<br>See the control chain diagrams on pages <a href="#">569</a> and <a href="#">570</a> .  |                                |
| <a href="#">24.01</a>                                  | <a href="#">Used speed reference</a>            | Displays the ramped and corrected speed reference (before speed error calculation). See the control chain diagram on page <a href="#">569</a> .<br>This parameter is read-only.  | -                              |
|  | -30000.00 ... 30000.00 rpm                      | Speed reference used for speed error calculation.  | See par. <a href="#">46.01</a> |
| <a href="#">24.02</a>                                  | <a href="#">Used speed feedback</a>             | Displays the speed feedback used for speed error calculation. See the control chain diagram on page <a href="#">569</a> .<br>This parameter is read-only.  | -                              |
|  | -30000.00 ... 30000.00 rpm                      | Speed feedback used for speed error calculation.   | See par. <a href="#">46.01</a> |
| <a href="#">24.03</a>                                  | <a href="#">Speed error filtered</a>            | Displays the filtered speed error. See the control chain diagram on page <a href="#">569</a> .<br>This parameter is read-only.   | -                              |
|  | -30000.0 ... 30000.0 rpm                        | Filtered speed error.  | See par. <a href="#">46.01</a> |
| <a href="#">24.04</a>                                  | <a href="#">Speed error inverted</a>            | Displays the inverted (unfiltered) speed error. See the control chain diagram on page <a href="#">569</a> .<br>This parameter is read-only.  | -                              |
|  | -30000.0 ... 30000.0 rpm                        | Inverted speed error.  | See par. <a href="#">46.01</a> |

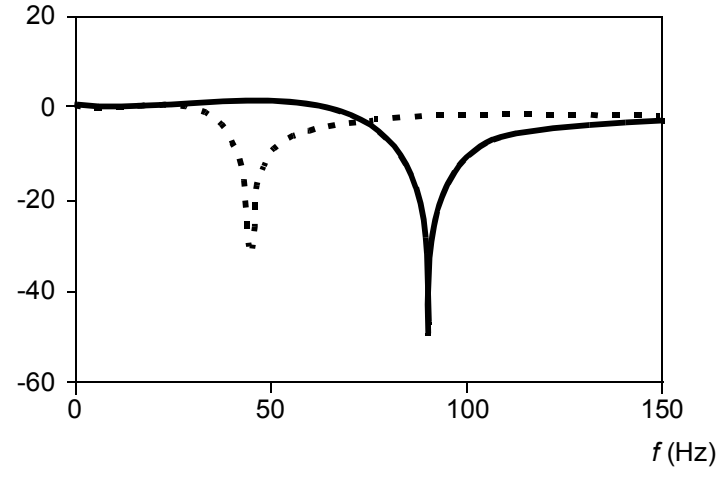
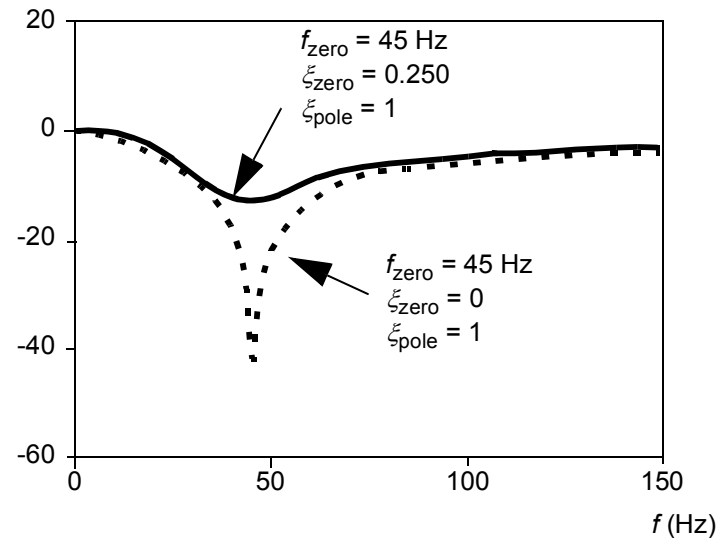

| No.   | Name/Value                     | Description  | Def/FbEq16            |
|-------|--------------------------------|--|-----------------------|
| 24.11 | <i>Speed correction</i>        | <p>Defines a speed reference correction, ie. a value added to the existing reference between ramping and limitation. This is useful to trim the speed if necessary, for example to adjust draw between sections of a paper machine.</p> <p><b>Note:</b> For safety reasons, the correction is not applied when an emergency stop is active.</p> <p> <b>WARNING!</b> If the speed reference correction exceeds <i>21.06 Zero speed limit</i>, a ramp stop may be impossible. Make sure the correction is reduced or removed when a ramp stop is required. See the control chain diagram on page 569.</p>   | 0.00 rpm              |
|       | -10000.00 ...<br>10000.00 rpm  | Speed reference correction.  | See par. <i>46.01</i> |
| 24.12 | <i>Speed error filter time</i> | <p>Defines the time constant of the speed error low-pass filter. If the used speed reference changes rapidly, the possible interferences in the speed measurement can be filtered with the speed error filter. Reducing the ripple with this filter may cause speed controller tuning problems. A long filter time constant and fast acceleration time contradict one another. A very long filter time results in unstable control.</p>  | 0 ms                  |
|       | 0...10000 ms                   | Speed error filtering time constant. 0 = filtering disabled.   | 1 = 1 ms              |
| 24.13 | <i>RFE speed filter</i>        | <p>Enables/disables resonance frequency filtering. The filtering is configured by parameters <i>24.13...24.17</i>.</p> <p>The speed error value coming to the speed controller is filtered by a common 2nd order band-elimination filter to eliminate the amplification of mechanical resonance frequencies.</p> <p><b>Note:</b> Tuning the resonance frequency filter requires a basic understanding of frequency filters. Incorrect tuning can amplify mechanical oscillations and damage the drive hardware. To ensure the stability of the speed controller, stop the drive or disable the filtering before changing the parameter settings.</p> <p>0 = Resonance frequency filtering disabled.<br/>1 = Resonance frequency filtering enabled.</p> | <i>Off</i>            |
|       | Off                            | 0.   | 0                     |
|       | On                             | 1.   | 1                     |

| No.   | Name/Value         | Description   | Def/FbEq16 |
|-------|--------------------|---|------------|
| 24.14 | Frequency of zero  | <p>Defines the zero frequency of the resonance frequency filter. The value must be set near the resonance frequency, which is filtered out before the speed controller. The drawing shows the frequency response.</p> <p><math>20\log_{10} H(\omega) </math></p>    | 45.00 Hz   |
|       | 0.50 ... 500.00 Hz | Zero frequency.   | 1 = 1 Hz   |
| 24.15 | Damping of zero    | <p>Defines the damping coefficient for parameter 24.14. The value of 0 corresponds to the maximum elimination of the resonance frequency.</p> <p><math>20\log_{10} H(\omega) </math></p>  <p><b>Note:</b> To ensure that the resonance frequency band is filtered (rather than amplified), the value of 24.15 must be smaller than 24.17.</p> | 0.000      |
|       | -1.000 ... 1.000   | Damping coefficient.  | 100 = 1    |

| No.   | Name/Value               | Description  | Def/FbEq16 |
|-------|--------------------------|--|------------|
| 24.16 | <i>Frequency of pole</i> | <p>Defines the frequency of pole of the resonance frequency filter.</p> <p><math>20\log_{10} H(\omega) </math></p> <p><b>Note:</b> If this value is very different from the value of 24.14, the frequencies near the frequency of pole are amplified, which can damage the driven machine.</p>   | 40.00 Hz   |
|       | 0.50 ... 500.00 Hz       | Frequency of pole.   | 1 = 1 Hz   |
| 24.17 | <i>Damping of pole</i>   | <p>Defines the damping coefficient for parameter 24.16. The coefficient shapes the frequency response of the resonance frequency filter. A narrower bandwidth results in better dynamic properties. By setting this parameter to 1, the effect of the pole is eliminated.</p> <p><math>20\log_{10} H(\omega) </math></p> <p><b>Note:</b> To ensure that the resonance frequency band is filtered (rather than amplified), the value of 24.15 must be smaller than 24.17.</p> | 0.250      |
|       | -1.000 ... 1.000         | Damping coefficient.   | 100 = 1    |

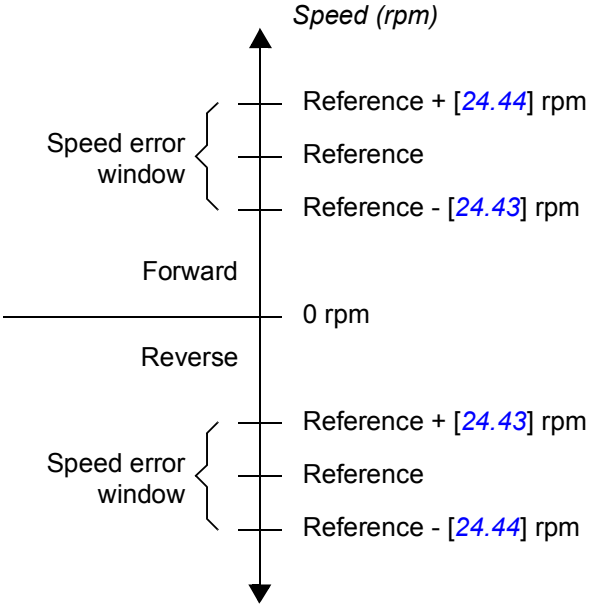
| No.   | Name/Value  | Description  | Def/FbEq16              |
|-------|---|--|-------------------------|
| 24.41 | <a href="#">Speed error window control enable</a> | <p>Enables/disables (or selects a source that enables/disables) speed error window control, sometimes also referred to as deadband control or strip break protection. It forms a speed supervision function for a torque-controlled drive, preventing the motor from running away if the material that is being held under tension breaks.</p> <p><b>Note:</b> Speed error window control is only effective when the <a href="#">Add</a> operating mode is active (see parameters <a href="#">19.12</a> and <a href="#">19.14</a>), or when the drive is a speed-controlled follower (see page <a href="#">32</a>).</p> <p>In normal operation, window control keeps the speed controller input at zero so the drive stays in torque control. If the motor load is lost, then the motor speed will rise as the torque controller tries to maintain torque. The speed error (speed reference - actual speed) will increase until it exits the speed error window. When this is detected, the exceeding part of the error value is connected to the speed controller. The speed controller produces a reference term relative to the input and gain (<a href="#">25.02 Speed proportional gain</a>) which the torque selector adds to the torque reference. The result is used as the internal torque reference for the drive.</p> <p>The activation of speed error window control is indicated by bit 3 of <a href="#">06.19 Speed control status word</a>.</p> <p>The window boundaries are defined by <a href="#">24.43 Speed error window high</a> and <a href="#">24.44 Speed error window low</a> as follows:</p> <div style="text-align: center;">  <p>The diagram shows a vertical axis labeled 'Speed (rpm)'. A horizontal line at 0 rpm is labeled 'Forward' above and 'Reverse' below. Two 'Speed error window' brackets are shown. The upper bracket (Forward) spans from 'Reference - [24.43] rpm' to 'Reference + [24.44] rpm'. The lower bracket (Reverse) spans from 'Reference - [24.44] rpm' to 'Reference + [24.43] rpm'.</p> </div> <p>Note that it is parameter <a href="#">24.44</a> (rather than <a href="#">24.43</a>) that defines the overspeed limit in both directions of rotation. This is because the function monitors speed error (which is negative in case of overspeed, positive in case of underspeed).</p> <p>0 = Speed error window control disabled<br/> 1 = Speed error window control enabled</p> | <a href="#">Disable</a> |
|       | Disable   | 0.   | 0                       |
|       | Enable  | 1.   | 1                       |
|       | <a href="#">Other [bit]</a>                       | Source selection (see <a href="#">Terms and abbreviations</a> on page <a href="#">112</a> ).   | -                       |

| No.                     | Name/Value                            | Description  | Def/FbEq16                  |
|-------------------------|---------------------------------------|--|-----------------------------|
| 24.42                   | <i>Speed window control mode</i>      | When speed error window control (see parameter 24.41 <i>Speed error window control enable</i> ) is enabled, this parameter determines whether the speed controller only observes the proportional term instead of all three (P, I and D) terms.  | <i>Normal speed control</i> |
|                         | Normal speed control                  | All three terms (parameters 25.02, 25.03 and 25.04) are observed by the speed controller.  | 0                           |
|                         | P-control                             | Only the proportional term (25.02) is observed by the speed controller. The integral and derivative terms are internally forced to zero.   | 1                           |
| 24.43                   | <i>Speed error window high</i>        | Defines the upper boundary of the speed error window. See parameter 24.41 <i>Speed error window control enable</i> .   | 0.00 rpm                    |
|                         | 0.00 ... 3000.00 rpm                  | Upper boundary of speed error window.  | See par. 46.01              |
| 24.44                   | <i>Speed error window low</i>         | Defines the lower boundary of the speed error window. See parameter 24.41 <i>Speed error window control enable</i> .   | 0.00 rpm                    |
|                         | 0.00 ... 3000.00 rpm                  | Lower boundary of speed error window.  | See par. 46.01              |
| 24.46                   | <i>Speed error step</i>               | Defines an additional speed error step given to the input of the speed controller (and added to the speed error value). This can be used in large drive systems for dynamic speed normalizing.<br> <b>WARNING!</b> Make sure the error step value is removed when a stop command is given. | 0.00 rpm                    |
|                         | -3000.00 ... 3000.00 rpm              | Speed error step.  | See par. 46.01              |
| <b>25 Speed control</b> |                                       | Speed controller settings.<br>See the control chain diagrams on pages 569 and 570.   |                             |
| 25.01                   | <i>Torque reference speed control</i> | Displays the speed controller output that is transferred to the torque controller. See the control chain diagram on page 570. This parameter is read-only.   | -                           |
|                         | -1600.0 ... 1600.0%                   | Limited speed controller output torque.  | See par. 46.03              |

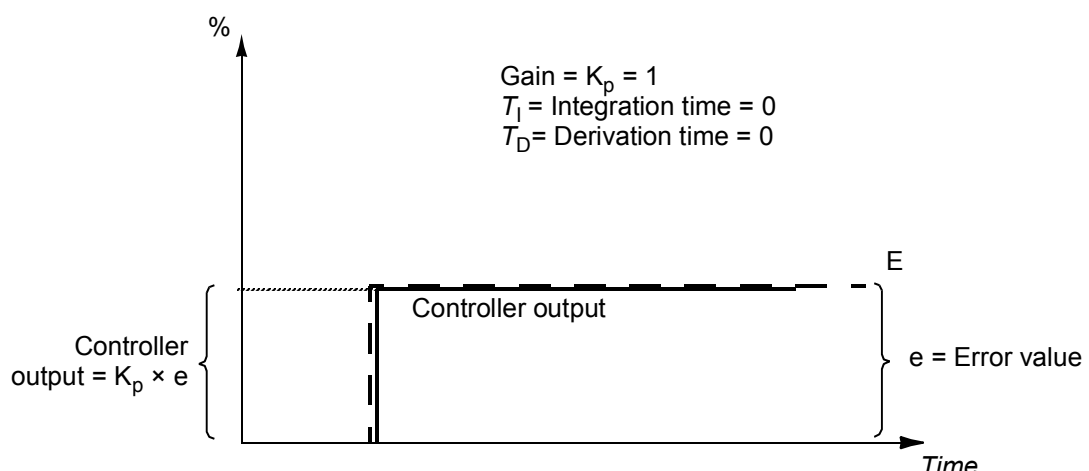
| No.   | Name/Value                     | Description   | Def/FbEq16                      |
|-------|--------------------------------|---|---------------------------------|
| 25.02 | <i>Speed proportional gain</i> | <p>Defines the proportional gain (<math>K_p</math>) of the speed controller. Too high a gain may cause speed oscillation. The figure below shows the speed controller output after an error step when the error remains constant.</p>  <p>If gain is set to 1.00, a 10% error (reference - actual value) in the motor synchronous speed produces a proportional term of 10%.</p> <p><b>Note:</b> This parameter is automatically set by the speed controller autotune function. See section <i>Speed controller autotune</i> (page 44).</p> | 10.00;<br>5.00<br>(95.21 b1/b2) |
|       | 0.00 ...250.00                 | Proportional gain for speed controller.   | 100 = 1                         |

| No.   | Name/Value                             | Description  | Def/FbEq16                       |
|---|--|--|----------------------------------|
| 25.03   | <i>Speed integration time</i>          | <p>Defines the integration time of the speed controller. The integration time defines the rate at which the controller output changes when the error value is constant and the proportional gain of the speed controller is 1. The shorter the integration time, the faster the continuous error value is corrected.</p> <p>Setting the integration time to zero disables the I-part of the controller. This is useful to do when tuning the proportional gain; adjust the proportional gain first, then return the integration time.</p> <p>The integrator has anti-windup control for operation at a torque or current limit.</p> <p>The figure below shows the speed controller output after an error step when the error remains constant.</p> | 2.50 s;<br>5.00<br>(95.21 b1/b2) |
| <p style="text-align: right;">Gain = <math>K_p = 1</math><br/> <math>T_I =</math> Integration time <math>&gt; 0</math><br/> <math>T_D =</math> Derivation time <math>= 0</math></p> <p style="text-align: right;">e = Error value</p> |  |  |                                  |
| 0.00 ... 1000.00 s  | Integration time for speed controller. | <p><b>Note:</b> This parameter is automatically set by the speed controller autotune function. See section <a href="#">Speed controller autotune</a> (page 44).</p>  | 10 = 1 s                         |

| No.   | Name/Value                             | Description   | Def/FbEq16 |
|-------|--|---|------------|
| 25.04 | <a href="#">Speed derivation time</a>  | <p>Defines the derivation time of the speed controller. Derivative action boosts the controller output if the error value changes. The longer the derivation time, the more the speed controller output is boosted during the change. If the derivation time is set to zero, the controller works as a PI controller, otherwise as a PID controller. The derivation makes the control more responsive for disturbances. For simple applications (especially those without an encoder), derivative time is not normally required and should be left at zero.</p> <p>The figure below shows the speed controller output after an error step when the error remains constant. The speed error derivative must be filtered with a low pass filter to eliminate external disturbances.</p> <div data-bbox="227 728 1246 1220" data-label="Figure"> </div> <p>Gain = <math>K_p = 1</math><br/> <math>T_I</math> = Integration time &gt; 0<br/> <math>T_D</math> = Derivation time &gt; 0<br/> <math>T_s</math> = Sample time period = 500 <math>\mu</math>s<br/> <math>\Delta e</math> = Error value change between two samples</p> | 0.000 s    |
|       | 0.000 ... 10.000 s                     | Derivation time for speed controller.   | 1000 = 1 s |
| 25.05 | <a href="#">Derivation filter time</a> | Defines the derivation filter time constant. See parameter <a href="#">25.04 Speed derivation time</a> .  | 8 ms       |
|       | 0...10000 ms                           | Derivation filter time constant.  | 1 = 1 ms   |

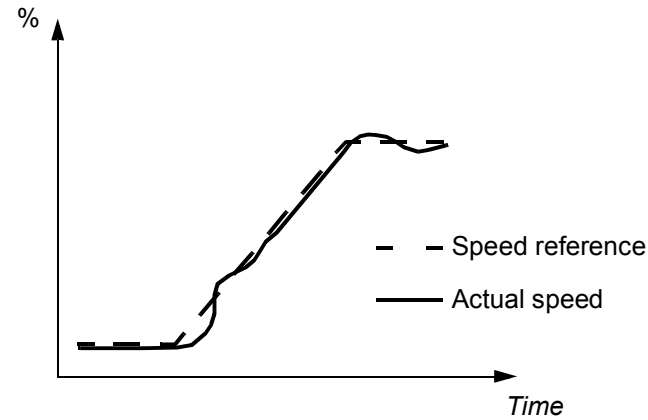
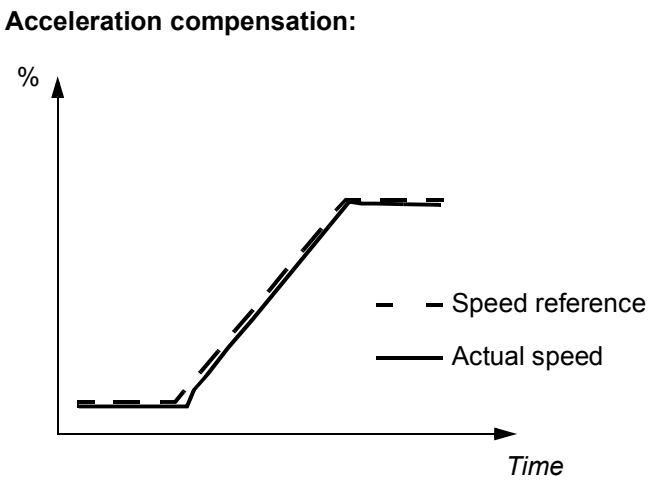

| No.                | Name/Value                      | Description   | Def/FbEq16 |
|--------------------|---------------------------------|---|------------|
| 25.06              | <i>Acc comp derivation time</i> | <p>Defines the derivation time for acceleration(/deceleration) compensation. In order to compensate for a high inertia load during acceleration, a derivative of the reference is added to the output of the speed controller. The principle of a derivative action is described under parameter <a href="#">25.04 Speed derivation time</a>.</p> <p><b>Note:</b> As a general rule, set this parameter to the value between 50 and 100% of the sum of the mechanical time constants of the motor and the driven machine.</p> <p>The figure below shows the speed responses when a high inertia load is accelerated along a ramp.</p> <p><b>No acceleration compensation:</b></p>  <p><b>Acceleration compensation:</b></p>  | 0.00 s     |
| 0.00 ... 1000.00 s |                                 | Acceleration compensation derivation time.  | 10 = 1 s   |
| 25.07              | <i>Acc comp filter time</i>     | <p>Defines the acceleration (or deceleration) compensation filter time constant. See parameters <a href="#">25.04 Speed derivation time</a> and <a href="#">25.06 Acc comp derivation time</a>.</p>   | 8.0 ms     |
| 0.0 ... 1000.0 ms  |                                 | Acceleration/deceleration compensation filter time.   | 1 = 1 ms   |

| No.   | Name/Value           | Description   | Def/FbEq16 |
|-------|----------------------|---|------------|
| 25.08 | <i>Drooping rate</i> | <p>Defines the droop rate in percent of the nominal motor speed. Drooping decreases the drive speed slightly as the drive load increases. The actual speed decrease at a certain operating point depends on the droop rate setting and the drive load (= torque reference / speed controller output). At 100% speed controller output, drooping is at its nominal level, i.e. equal to the value of this parameter. The drooping effect decreases linearly to zero along with the decreasing load.</p> <p>The droop rate can be used e.g. to adjust the load sharing in a Master/Follower application run by several drives. In a Master/Follower application the motor shafts are coupled to each other.</p> <p>The correct droop rate for a process must be found out case by case in practice.</p> | 0.00%      |

**Speed decrease** = Speed controller output × Drooping × Nominal speed

**Example:** Speed controller output is 50%, droop rate is 1%, nominal speed of the drive is 1500 rpm.

Speed decrease = 0.50 × 0.01 × 1500 rpm = 7.5 rpm.

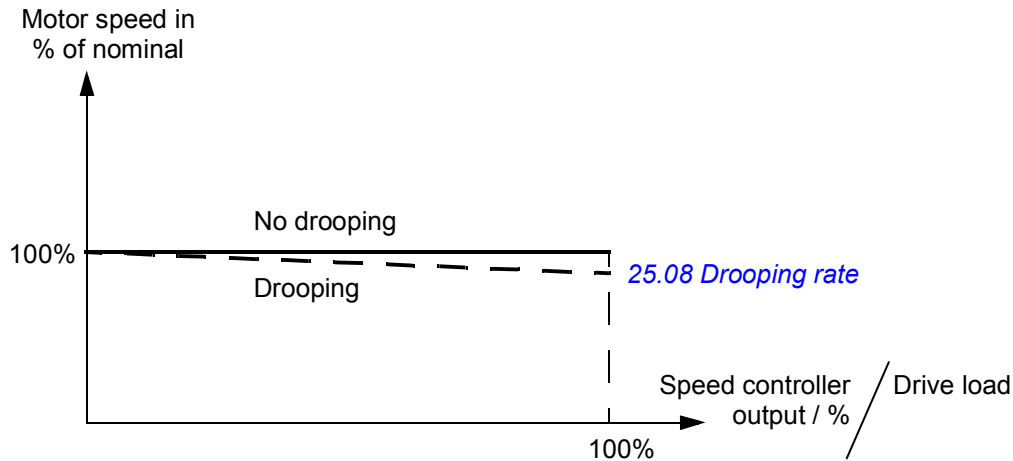

|                  |   |  |                     |
|------------------|---|--|---------------------|
| 0.00 ... 100.00% | Droop rate.   | 100 = 1%   |                     |
| 25.09            | <i>Speed ctrl balancing enable</i>                                    | <p>Selects the source for enabling/disabling speed controller output balancing.</p> <p>This function is used to generate a smooth, “bumpless” transfer from a torque- or tension-controlled motor back to being speed-controlled. When balancing is enabled, the output of the speed controller is forced to the value of <a href="#">25.10 Speed ctrl balancing ref.</a></p> <p>Balancing is also possible in the ramp generator (see parameter <a href="#">23.26 Ramp out balancing enable</a>).</p> <p>0 = Disabled<br/>1 = Enabled</p> | <i>Not selected</i> |
| Not selected     | 0.  | 1  |                     |
| Selected         | 1.  | 2  |                     |
| DI1              | Digital input DI1 ( <a href="#">10.02 DI delayed status</a> , bit 0). | 2  |                     |
| DI2              | Digital input DI2 ( <a href="#">10.02 DI delayed status</a> , bit 1). | 3  |                     |
| DI3              | Digital input DI3 ( <a href="#">10.02 DI delayed status</a> , bit 2). | 4  |                     |
| DI4              | Digital input DI4 ( <a href="#">10.02 DI delayed status</a> , bit 3). | 5  |                     |
| DI5              | Digital input DI5 ( <a href="#">10.02 DI delayed status</a> , bit 4). | 6  |                     |

| No.          | Name/Value                           | Description  | Def/FbEq16                                       |
|--------------|--------------------------------------|--|--|
|              | DI6                                  | Digital input DI6 ( <a href="#">10.02 DI delayed status</a> , bit 5).  | 7  |
|              | DIO1                                 | Digital input/output DIO1 ( <a href="#">11.02 DIO delayed status</a> , bit 0).   | 10   |
|              | DIO2                                 | Digital input/output DIO2 ( <a href="#">11.02 DIO delayed status</a> , bit 1).   | 11   |
|              | <i>Other [bit]</i>                   | Source selection (see <a href="#">Terms and abbreviations</a> on page 112).  | -  |
| <b>25.10</b> | <i>Speed ctrl<br/>balancing ref</i>  | Defines the reference used in speed controller output balancing. The output of the speed controller is forced to this value when balancing is enabled by parameter <a href="#">25.09 Speed ctrl balancing enable</a> . | 0.0%   |
|              | -300.0 ... 300.0%                    | Speed control output balancing reference.  | See par. <a href="#">46.03</a>                   |
| <b>25.11</b> | <i>Speed control min<br/>torque</i>  | Defines the minimum speed controller output torque.  | -300.0%  |
|              | -1600.0 ... 0.0%                     | Minimum speed controller output torque.  | See par. <a href="#">46.03</a>                   |
| <b>25.12</b> | <i>Speed control max<br/>torque</i>  | Defines the maximum speed controller output torque.  | 300.0%   |
|              | 0.0 ... 1600.0%                      | Maximum speed controller output torque.  | See par. <a href="#">46.03</a>                   |
| <b>25.13</b> | <i>Min torq sp ctrl em<br/>stop</i>  | Defines the minimum speed controller output torque during a ramped emergency stop (Off1 or Off3).  | -400.0%  |
|              | -1600.0 ... 0.0%                     | Minimum speed controller output torque for ramped emergency stop.  | See par. <a href="#">46.03</a>                   |
| <b>25.14</b> | <i>Max torq sp ctrl em<br/>stop</i>  | Defines the maximum speed controller output torque during a ramped emergency stop (Off1 or Off3).  | 400.0%   |
|              | 0.0 ... 1600.0%                      | Maximum speed controller output torque for ramped emergency stop.  | See par. <a href="#">46.03</a>                   |
| <b>25.15</b> | <i>Proportional gain<br/>em stop</i> | Defines the proportional gain for the speed controller when an emergency stop is active. See parameter <a href="#">25.02 Speed proportional gain</a> .   | 10.00;<br>5.00<br>( <a href="#">95.21</a> b1/b2) |
|              | 1.00 ... 250.00                      | Proportional gain upon an emergency stop.  | 100 = 1  |

| No.   | Name/Value                   | Description   | Def/FbEq16 |
|-------|------------------------------|---|------------|
| 25.18 | <i>Speed adapt min limit</i> | <p>Minimum actual speed for speed controller adaptation. Speed controller gain and integration time can be adapted according to actual speed (<i>90.01 Motor speed for control</i>). This is done by multiplying the gain (<i>25.02 Speed proportional gain</i>) and integration time (<i>25.03 Speed integration time</i>) by coefficients at certain speeds. The coefficients are defined individually for both gain and integration time.</p> <p>When actual speed is below or equal to <i>25.18 Speed adapt min limit</i>, the gain and integration time are multiplied by <i>25.21 Kp adapt coef at min speed</i> and <i>25.22 Ti adapt coef at min speed</i> respectively.</p> <p>When actual speed is equal to or above <i>25.19 Speed adapt max limit</i>, no adaptation takes place (the coefficient is 1).</p> <p>When actual speed is between <i>25.18 Speed adapt min limit</i> and <i>25.19 Speed adapt max limit</i>, the coefficients for the gain and integration time are calculated linearly on the basis of the breakpoints.</p> <p>See also the block diagram on page <i>570</i>.</p> | 0 rpm      |

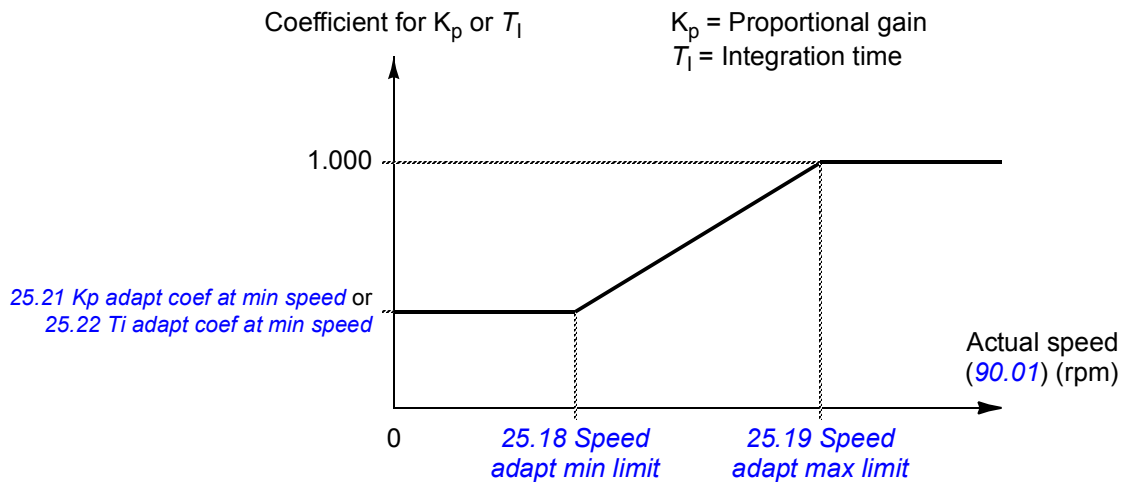

|                  |  |   |       |
|------------------|--|---|-------|
| 0...30000 rpm    | Minimum actual speed for speed controller adaptation.  | 1 = 1 rpm   |       |
| 25.19            | <i>Speed adapt max limit</i>                           | Maximum actual speed for speed controller adaptation. See parameter <i>25.18 Speed adapt min limit</i> .  | 0 rpm |
| 0...30000 rpm    | Maximum actual speed for speed controller adaptation.  | 1 = 1 rpm   |       |
| 25.21            | <i>Kp adapt coef at min speed</i>                      | Proportional gain coefficient at minimum actual speed. See parameter <i>25.18 Speed adapt min limit</i> . | 1.000 |
| 0.000 ... 10.000 | Proportional gain coefficient at minimum actual speed. | 1000 = 1  |       |
| 25.22            | <i>Ti adapt coef at min speed</i>                      | Integration time coefficient at minimum actual speed. See parameter <i>25.18 Speed adapt min limit</i> .  | 1.000 |
| 0.000 ... 10.000 | Integration time coefficient at minimum actual speed.  | 1000 = 1  |       |

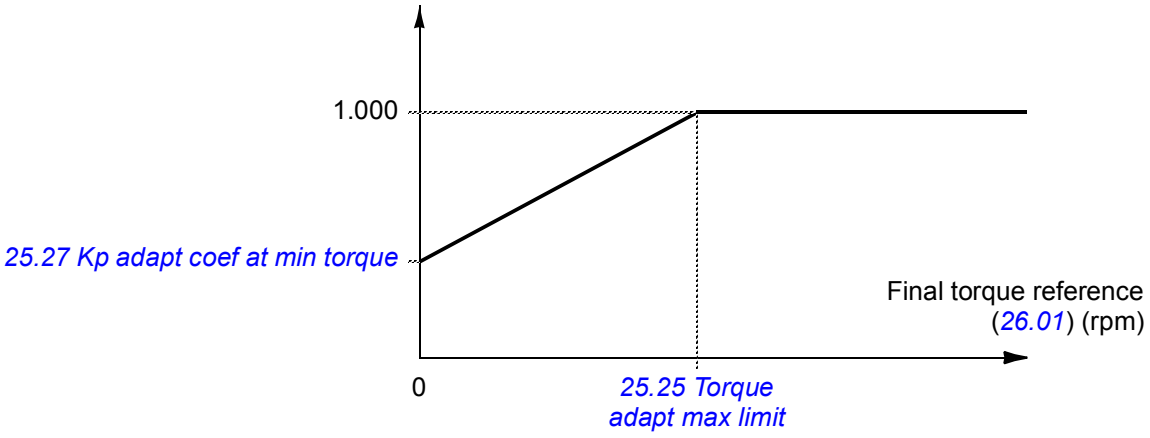
| No.   | Name/Value                         | Description   | Def/FbEq16     |
|---|------------------------------------|---|----------------|
| 25.25   | <i>Torque adapt max limit</i>      | <p>Maximum torque reference for speed controller adaptation. Speed controller gain can be adapted according to the final unlimited torque reference (26.01 <i>Torque reference to TC</i>). This can be used to smooth out disturbances caused by a small load and backlashes.</p> <p>The functionality involves multiplying the gain (25.02 <i>Speed proportional gain</i>) by a coefficient within a certain torque range.</p> <p>When the torque reference is 0%, the gain is multiplied by the value of parameter 25.27 <i>Kp adapt coef at min torque</i>.</p> <p>When the torque reference is equal to or above 25.25 <i>Torque adapt max limit</i>, no adaptation takes place (the coefficient is 1).</p> <p>Between 0% and 25.25 <i>Torque adapt max limit</i>, the coefficient for the gain is calculated linearly on the basis of the breakpoints.</p> <p>Filtering can be applied on the torque reference using parameter 25.26 <i>Torque adapt filt time</i>.</p> <p>See also the block diagram on page 570.</p> | 0.0%           |
| <p>Coefficient for <math>K_p</math> (proportional gain)</p>  |                                    |   |                |
| 0.0 ... 1600.0%   |                                    | Maximum torque reference for speed controller adaptation.   | See par. 46.03 |
| 25.26   | <i>Torque adapt filt time</i>      | <p>Defines a filter time constant for the adaptation, in effect adjusting the rate of change of the gain.</p> <p>See parameter 25.25 <i>Torque adapt max limit</i>.</p>   | 0.000 s        |
| 0.000 ... 100.000 s   |                                    | Filter time for adaptation.   | 100 = 1 s      |
| 25.27   | <i>Kp adapt coef at min torque</i> | <p>Proportional gain coefficient at 0% torque reference.</p> <p>See parameter 25.25 <i>Torque adapt max limit</i>.</p>  | 1.000          |
| 0.000 ... 10.000  |                                    | Proportional gain coefficient at 0% torque reference.   | 1000 = 1       |

| No.   | Name/Value                            | Description   | Def/FbEq16    |
|-------|---------------------------------------|---|---------------|
| 25.30 | <i>Flux adaption enable</i>           | <p>Enables/disables speed controller adaptation based on motor flux reference (<i>01.24 Flux actual %</i>).</p> <p>The proportional gain of the speed controller is multiplied by a coefficient of 0...1 between 0...100% flux reference respectively.</p> <p>See also the block diagram on page <i>570</i>.</p> <div data-bbox="373 483 1307 927" data-label="Figure"> <p>The graph plots the coefficient for <math>K_p</math> (proportional gain) on the y-axis against Flux reference (01.24) (%) on the x-axis. The y-axis ranges from 0.000 to 1.000. The x-axis ranges from 0 to 100. A solid line starts at the origin (0, 0.000) and rises linearly to the point (100, 1.000). From x=100, the line continues horizontally at y=1.000. Dashed lines indicate the coordinates of the point (100, 1.000).</p> </div>  | <i>Enable</i> |
|       | Disable                               | Speed controller adaptation based on flux reference disabled.   | 0             |
|       | Enable                                | Speed controller adaptation based on flux reference enabled.  | 1             |
| 25.33 | <i>Speed controller autotune</i>      | <p>Activates (or selects a source that activates) the speed controller autotune function. See section <i>Speed controller autotune</i> (page <i>44</i>).</p> <p>The autotune will automatically set parameters <i>25.02 Speed proportional gain</i>, <i>25.03 Speed integration time</i> and <i>25.37 Mechanical time constant</i>.</p> <p>The prerequisites for performing the autotune routine are:</p> <ul style="list-style-type: none"> <li>the motor identification run (ID run) has been successfully completed</li> <li>the speed and torque limits (parameter group <i>30 Limits</i>) have been set</li> <li>speed feedback filtering (parameter group <i>90 Feedback selection</i>), speed error filtering (<i>24 Speed reference conditioning</i>) and zero speed (<i>21 Start/stop mode</i>) have been set, and</li> <li>the drive has been started and is running in speed control mode.</li> </ul> <p><b>⚠ WARNING!</b> The motor and machinery will run against the torque and speed limits during the autotune routine. MAKE SURE IT IS SAFE TO ACTIVATE THE AUTOTUNE FUNCTION!</p> <p>The autotune routine can be aborted by stopping the drive.</p> <p>0 -&gt; 1 = Activate speed controller autotune</p> <p><b>Note:</b> The value does not revert to 0 automatically.</p> | <i>Off</i>    |
|       | Off                                   | 0.  | 0             |
|       | On                                    | 1.  | 1             |
|       | <i>Other [bit]</i>                    | Source selection (see <i>Terms and abbreviations</i> on page <i>112</i> ).  | -             |
| 25.34 | <i>Speed controller autotune mode</i> | Defines a control preset for the speed controller autotune function. The setting affects the way the torque reference will respond to a speed reference step.   | <i>Normal</i> |
|       | Smooth                                | Slow but robust response.   | 0             |

| No.   | Name/Value                       | Description   | Def/FbEq16                     |
|-------|----------------------------------|---|--------------------------------|
|       | Normal                           | Medium setting.   | 1                              |
|       | Tight                            | Fast response. May produce too high a gain value for some applications.   | 2                              |
| 25.37 | <i>Mechanical time constant</i>  | Mechanical time constant of the drive and the machinery as determined by the speed controller autotune function. The value can be adjusted manually.  | -                              |
|       | 0.00 ... 1000.00 s               | Mechanical time constant.   | 10 = 1 s                       |
| 25.38 | <i>Autotune torque step</i>      | Defines an added torque value used by the autotune function. This value is scaled to motor nominal torque. Note that the torque used by the autotune function can also be limited by the torque limits (in parameter group <a href="#">30 Limits</a> ) and nominal motor torque.  | 10.00%                         |
|       | 0.00 ... 100.00%                 | Autotune torque step.   | 100 = 1%                       |
| 25.39 | <i>Autotune speed step</i>       | Defines a speed value added to the initial speed for the autotune routine. The initial speed (speed used when autotune is activated) plus the value of this parameter is the calculated maximum speed used by the autotune routine. The maximum speed can also be limited by the speed limits (in parameter group <a href="#">30 Limits</a> ) and nominal motor speed. The value is scaled to motor nominal speed.<br><b>Note:</b> The motor will exceed the calculated maximum speed slightly at the end of each acceleration stage. | 10.00%                         |
|       | 0.00 ... 100.00%                 | Autotune speed step.  | 100 = 1%                       |
| 25.40 | <i>Autotune repeat times</i>     | Determines how many acceleration/deceleration cycles are performed during the autotune routine. Increasing the value will improve the accuracy of the autotune function, and allow the use of smaller torque or speed step values.  | 10                             |
|       | 1...10                           | Number of cycles during autotune routine.   | 1 = 1                          |
| 25.53 | <i>Torque prop reference</i>     | Displays the output of the proportional (P) part of the speed controller. See the control chain diagram on page <a href="#">570</a> . This parameter is read-only.  | -                              |
|       | -30000.0 ... 30000.0%            | P-part output of speed controller.  | See par. <a href="#">46.03</a> |
| 25.54 | <i>Torque integral reference</i> | Displays the output of the integral (I) part of the speed controller. See the control chain diagram on page <a href="#">570</a> . This parameter is read-only.  | -                              |
|       | -30000.0 ... 30000.0%            | I-part output of speed controller.  | See par. <a href="#">46.03</a> |
| 25.55 | <i>Torque deriv reference</i>    | Displays the output of the derivative (D) part of the speed controller. See the control chain diagram on page <a href="#">570</a> . This parameter is read-only.  | -                              |
|       | -30000.0 ... 30000.0%            | D-part output of speed controller.  | See par. <a href="#">46.03</a> |
| 25.56 | <i>Torque acc compensation</i>   | Displays the output of the acceleration compensation function. See the control chain diagram on page <a href="#">570</a> . This parameter is read-only.   | -                              |
|       | -30000.0 ... 30000.0%            | Output of acceleration compensation function.   | See par. <a href="#">46.03</a> |

## 240 Parameters



| No.                              | Name/Value                         | Description   | Def/FbEq16        |
|----------------------------------|------------------------------------|---|-------------------|
| 25.57                            | <i>Torque reference unbalanced</i> | Displays the acceleration-compensated output of the speed controller. See the control chain diagram on page 570.<br>This parameter is read-only.  | -                 |
|                                  | -30000.0 ...<br>30000.0%           | Acceleration-compensated output of speed controller.  | See par.<br>46.03 |
| <b>26 Torque reference chain</b> |                                    | Settings for the torque reference chain.<br>See the control chain diagrams on pages 571 and 573.  |                   |
| 26.01                            | <i>Torque reference to TC</i>      | Displays the final torque reference given to the torque controller in percent. This reference is then acted upon by various final limiters, like power, torque, load etc.<br>See the control chain diagrams on pages 573 and 574.<br>This parameter is read-only. | -                 |
|                                  | -1600.0 ... 1600.0%                | Torque reference for torque control.  | See par.<br>46.03 |
| 26.02                            | <i>Torque reference used</i>       | Displays the final torque reference (in percent of motor nominal torque) given to the DTC core, and comes after frequency, voltage and torque limitation.<br>See the control chain diagram on page 574.<br>This parameter is read-only.                           | -                 |
|                                  | -1600.0 ... 1600.0%                | Torque reference for torque control.  | See par.<br>46.03 |
| 26.08                            | <i>Minimum torque ref</i>          | Defines the minimum torque reference. Allows for local limiting of the torque reference before it is passed on to the torque ramp controller. For absolute torque limiting, refer to parameter 30.19 <i>Minimum torque 1</i> .                                    | -300.0%           |
|                                  | -1000.0 ... 0.0%                   | Minimum torque reference.   | See par.<br>46.03 |
| 26.09                            | <i>Maximum torque ref</i>          | Defines the maximum torque reference. Allows for local limiting of the torque reference before it is passed on to the torque ramp controller. For absolute torque limiting, refer to parameter 30.20 <i>Maximum torque 1</i> .                                    | 300.0%            |
|                                  | 0.0 ... 1000.0%                    | Maximum torque reference.   | See par.<br>46.03 |



| No.                        | Name/Value   | Description  | Def/FbEq16 |
|----------------------------|--|--|------------|
| 26.11                      | <i>Torque ref1 source</i>  | <p>Selects torque reference source 1.</p> <p>Two signal sources can be defined by this parameter and <a href="#">26.12 Torque ref2 source</a>. A digital source selected by <a href="#">26.14 Torque ref1/2 selection</a> can be used to switch between the two sources, or a mathematical function (<a href="#">26.13 Torque ref1 function</a>) applied to the two signals to create the reference.</p> | Zero       |
|                            |  |  |            |
| Zero                       | None.  | 0  |            |
| AI1 scaled                 | <a href="#">12.12 AI1 scaled value</a> (see page 158).   | 1  |            |
| AI2 scaled                 | <a href="#">12.22 AI2 scaled value</a> (see page 160).   | 2  |            |
| FB A ref1                  | <a href="#">03.05 FB A reference 1</a> (see page 119).   | 4  |            |
| FB A ref2                  | <a href="#">03.06 FB A reference 2</a> (see page 120).   | 5  |            |
| EFB ref1                   | <a href="#">03.09 EFB reference 1</a> (see page 120).  | 8  |            |
| EFB ref2                   | <a href="#">03.10 EFB reference 2</a> (see page 120).  | 9  |            |
| DDCS ctrl ref1             | <a href="#">03.11 DDCS controller ref 1</a> (see page 120).  | 10   |            |
| DDCS ctrl ref2             | <a href="#">03.12 DDCS controller ref 2</a> (see page 120).  | 11   |            |
| M/F reference 1            | <a href="#">03.13 M/F or D2D ref1</a> (see page 120).  | 12   |            |
| M/F reference 2            | <a href="#">03.14 M/F or D2D ref2</a> (see page 120).  | 13   |            |
| Motor potentiometer        | <a href="#">22.80 Motor potentiometer ref act</a> (output of the motor potentiometer).   | 15   |            |
| PID                        | <a href="#">40.01 Process PID output actual</a> (output of the process PID controller).  | 16   |            |
| Control panel (ref saved)  | Control panel reference, with initial value from last-used panel reference. See section <a href="#">Using the control panel as an external control source</a> (page 21).       | 18   |            |
| Control panel (ref copied) | Control panel reference, with initial value from previous source or actual value. See section <a href="#">Using the control panel as an external control source</a> (page 21). | 19   |            |
| <i>Other</i>               | Source selection (see <a href="#">Terms and abbreviations</a> on page 112).  | -  |            |
| 26.12                      | <i>Torque ref2 source</i>  | <p>Selects torque reference source 2.</p> <p>For the selections, and a diagram of reference source selection, see parameter <a href="#">26.11 Torque ref1 source</a>.</p>  | Zero       |

## 242 Parameters

| No.   | Name/Value                      | Description  | Def/FbEq16                |
|-------|---------------------------------|--|---------------------------|
| 26.13 | <i>Torque ref1 function</i>     | Selects a mathematical function between the reference sources selected by parameters <a href="#">26.11 Torque ref1 source</a> and <a href="#">26.12 Torque ref2 source</a> . See diagram at <a href="#">26.11 Torque ref1 source</a> .   | <i>Ref1</i>               |
|       | Ref1                            | Signal selected by <a href="#">26.11 Torque ref1 source</a> is used as torque reference 1 as such (no function applied).   | 0                         |
|       | Add (ref1 + ref2)               | The sum of the reference sources is used as torque reference 1.  | 1                         |
|       | Sub (ref1 - ref2)               | The subtraction ([ <a href="#">26.11 Torque ref1 source</a> ] - [ <a href="#">26.12 Torque ref2 source</a> ]) of the reference sources is used as torque reference 1.  | 2                         |
|       | Mul (ref1 × ref2)               | The multiplication of the reference sources is used as torque reference 1.   | 3                         |
|       | Min (ref1, ref2)                | The smaller of the reference sources is used as torque reference 1.  | 4                         |
|       | Max (ref1, ref2)                | The greater of the reference sources is used as torque reference 1.  | 5                         |
| 26.14 | <i>Torque ref1/2 selection</i>  | Configures the selection between torque references 1 and 2. See diagram at <a href="#">26.11 Torque ref1 source</a> .<br>0 = Torque reference 1<br>1 = Torque reference 2  | <i>Torque reference 1</i> |
|       | Torque reference 1              | 0.   | 0                         |
|       | Torque reference 2              | 1.   | 1                         |
|       | Follow Ext1/Ext2 selection      | Torque reference 1 is used when external control location EXT1 is active. Torque reference 2 is used when external control location EXT2 is active. See also parameter <a href="#">19.11 Ext1/Ext2 selection</a> .   | 2                         |
|       | DI1                             | Digital input DI1 ( <a href="#">10.02 DI delayed status</a> , bit 0).  | 3                         |
|       | DI2                             | Digital input DI2 ( <a href="#">10.02 DI delayed status</a> , bit 1).  | 4                         |
|       | DI3                             | Digital input DI3 ( <a href="#">10.02 DI delayed status</a> , bit 2).  | 5                         |
|       | DI4                             | Digital input DI4 ( <a href="#">10.02 DI delayed status</a> , bit 3).  | 6                         |
|       | DI5                             | Digital input DI5 ( <a href="#">10.02 DI delayed status</a> , bit 4).  | 7                         |
|       | DI6                             | Digital input DI6 ( <a href="#">10.02 DI delayed status</a> , bit 5).  | 8                         |
|       | <i>Other [bit]</i>              | Source selection (see <a href="#">Terms and abbreviations</a> on page 112).  | -                         |
| 26.15 | <i>Load share</i>               | Defines the scaling factor for the torque reference (the torque reference is multiplied by the value).<br>This allows drives sharing the load between two motors on the same mechanical plant to be tailored to share the correct amount each, yet use the same master torque reference. | 1.000                     |
|       | -8.000 ... 8.000                | Torque reference scaling factor.   | 1000 = 1                  |
| 26.16 | <i>Torque additive 1 source</i> | Selects the source of torque reference additive 1.<br><b>Note:</b> For safety reasons, the additive is not applied when an emergency stop is active.<br>See the control chain diagram on page 571.<br>For the selections, see parameter <a href="#">26.11 Torque ref1 source</a> .       | <i>Zero</i>               |
| 26.17 | <i>Torque ref filter time</i>   | Defines a low-pass filter time constant for the torque reference.  | 0.000 s                   |
|       | 0.000 ... 30.000 s              | Filter time constant for torque reference.   | 1000 = 1 s                |

| No.   | Name/Value                         | Description   | Def/FbEq16                     |
|-------|------------------------------------|---|--------------------------------|
| 26.18 | <i>Torque ramp up time</i>         | Defines the torque reference ramp-up time, ie. the time for the reference to increase from zero to nominal motor torque.  | 0.000 s                        |
|       | 0.000 ... 60.000 s                 | Torque reference ramp-up time.  | 100 = 1 s                      |
| 26.19 | <i>Torque ramp down time</i>       | Defines the torque reference ramp-down time, ie. the time for the reference to decrease from nominal motor torque to zero.  | 0.000 s                        |
|       | 0.000 ... 60.000 s                 | Torque reference ramp-down time.  | 100 = 1 s                      |
| 26.25 | <i>Torque additive 2 source</i>    | <p>Selects the source of torque reference additive 2. The value received from the selected source is added to the torque reference after operating mode selection. Because of this, the additive can be used in speed and torque modes.</p> <p><b>Note:</b> For safety reasons, the additive is not applied when an emergency stop is active.</p> <p> <b>WARNING!</b> If the additive exceeds the limits set by parameters <a href="#">25.11 Speed control min torque</a> and <a href="#">25.12 Speed control max torque</a>, a ramp stop may be impossible. Make sure the additive is reduced or removed when a ramp stop is required eg. by using parameter <a href="#">26.26 Force torque ref add 2 zero</a>.</p> <p>See the control chain diagram on page <a href="#">573</a>.<br/>For the selections, see parameter <a href="#">26.11 Torque ref1 source</a>.</p> | Zero                           |
| 26.26 | <i>Force torque ref add 2 zero</i> | <p>Selects a source that forces torque reference additive 2 (see parameter <a href="#">26.25 Torque additive 2 source</a>) to zero.</p> <p>0 = Normal operation<br/>1 = Force torque reference additive 2 to zero.</p>  | Not selected                   |
|       | Not selected                       | 0.  | 0                              |
|       | Selected                           | 1.  | 1                              |
|       | DI1                                | Digital input DI1 ( <a href="#">10.02 DI delayed status</a> , bit 0).   | 2                              |
|       | DI2                                | Digital input DI2 ( <a href="#">10.02 DI delayed status</a> , bit 1).   | 3                              |
|       | DI3                                | Digital input DI3 ( <a href="#">10.02 DI delayed status</a> , bit 2).   | 4                              |
|       | DI4                                | Digital input DI4 ( <a href="#">10.02 DI delayed status</a> , bit 3).   | 5                              |
|       | DI5                                | Digital input DI5 ( <a href="#">10.02 DI delayed status</a> , bit 4).   | 6                              |
|       | DI6                                | Digital input DI6 ( <a href="#">10.02 DI delayed status</a> , bit 5).   | 7                              |
|       | DIO1                               | Digital input/output DIO1 ( <a href="#">11.02 DIO delayed status</a> , bit 0).  | 10                             |
|       | DIO2                               | Digital input/output DIO2 ( <a href="#">11.02 DIO delayed status</a> , bit 1).  | 11                             |
|       | <i>Other [bit]</i>                 | Source selection (see <a href="#">Terms and abbreviations</a> on page <a href="#">112</a> ).  | -                              |
| 26.41 | <i>Torque step</i>                 | <p>When enabled by parameter <a href="#">26.42 Torque step enable</a>, adds an additional step to the torque reference.</p> <p><b>Note:</b> For safety reasons, the torque step is not applied when an emergency stop is active.</p> <p> <b>WARNING!</b> If the torque step exceeds the limits set by parameters <a href="#">25.11 Speed control min torque</a> and <a href="#">25.12 Speed control max torque</a>, a ramp stop may be impossible. Make sure the torque step is reduced or removed when a ramp stop is required eg. by using parameter <a href="#">26.42 Torque step enable</a>.</p>   | 0.0%                           |
|       | -300.0 ... 300.0%                  | Torque step.  | See par. <a href="#">46.03</a> |
| 26.42 | <i>Torque step enable</i>          | Enables/disables a torque step (defined by parameter <a href="#">26.41 Torque step</a> ).   | Disable                        |
|       | Disable                            | Torque step disabled.   | 0                              |

| No.   | Name/Value                            | Description   | Def/FbEq16          |
|-------|---------------------------------------|---|---------------------|
|       | Enable                                | Torque step enabled.  | 1                   |
| 26.51 | <i>Oscillation damping</i>            | Parameters 26.51...26.58 configure the oscillation damping function. See section <i>Oscillation damping</i> (page 47), and the block diagram on page 573.<br>This parameter enables (or selects a source that enables) the oscillation damping algorithm.<br>1 = Oscillation damping algorithm enabled  | <i>Not selected</i> |
|       | Not selected                          | 0.  | 0                   |
|       | Selected                              | 1.  | 1                   |
|       | DI1                                   | Digital input DI1 ( <i>10.02 DI delayed status</i> , bit 0).  | 2                   |
|       | DI2                                   | Digital input DI2 ( <i>10.02 DI delayed status</i> , bit 1).  | 3                   |
|       | DI3                                   | Digital input DI3 ( <i>10.02 DI delayed status</i> , bit 2).  | 4                   |
|       | DI4                                   | Digital input DI4 ( <i>10.02 DI delayed status</i> , bit 3).  | 5                   |
|       | DI5                                   | Digital input DI5 ( <i>10.02 DI delayed status</i> , bit 4).  | 6                   |
|       | DI6                                   | Digital input DI6 ( <i>10.02 DI delayed status</i> , bit 5).  | 7                   |
|       | DIO1                                  | Digital input/output DIO1 ( <i>11.02 DIO delayed status</i> , bit 0).   | 10                  |
|       | DIO2                                  | Digital input/output DIO2 ( <i>11.02 DIO delayed status</i> , bit 1).   | 11                  |
|       | <i>Other [bit]</i>                    | Source selection (see <i>Terms and abbreviations</i> on page 112).  | -                   |
| 26.52 | <i>Oscillation damping out enable</i> | Determines (or selects a source that determines) whether the output of the oscillation damping function is applied to the torque reference or not.<br><b>Note:</b> Before enabling the oscillation damping output, adjust parameters 26.53...26.57. Then monitor the input signal (selected by 26.53) and the output (26.58) to make sure that the correction is safe to apply.<br>1 = Apply oscillation damping output to torque reference | <i>Not selected</i> |
|       | Not selected                          | 0.  | 0                   |
|       | Selected                              | 1.  | 1                   |
|       | DI1                                   | Digital input DI1 ( <i>10.02 DI delayed status</i> , bit 0).  | 2                   |
|       | DI2                                   | Digital input DI2 ( <i>10.02 DI delayed status</i> , bit 1).  | 3                   |
|       | DI3                                   | Digital input DI3 ( <i>10.02 DI delayed status</i> , bit 2).  | 4                   |
|       | DI4                                   | Digital input DI4 ( <i>10.02 DI delayed status</i> , bit 3).  | 5                   |
|       | DI5                                   | Digital input DI5 ( <i>10.02 DI delayed status</i> , bit 4).  | 6                   |
|       | DI6                                   | Digital input DI6 ( <i>10.02 DI delayed status</i> , bit 5).  | 7                   |
|       | DIO1                                  | Digital input/output DIO1 ( <i>11.02 DIO delayed status</i> , bit 0).   | 10                  |
|       | DIO2                                  | Digital input/output DIO2 ( <i>11.02 DIO delayed status</i> , bit 1).   | 11                  |
|       | <i>Other [bit]</i>                    | Source selection (see <i>Terms and abbreviations</i> on page 112).  | -                   |
| 26.53 | <i>Oscillation compensation input</i> | Selects the input signal for the oscillation damping function.<br><b>Note:</b> Before changing this parameter run-time, disable the oscillation damping output using parameter 26.52. Monitor the behavior of 26.58 before re-enabling the output.  | <i>Speed error</i>  |
|       | Speed error                           | 24.01 <i>Used speed reference</i> - unfiltered motor speed. <b>Note:</b> This setting is not supported in scalar motor control mode.  | 0                   |
|       | DC voltage                            | 01.11 <i>DC voltage</i> . (The value is internally filtered.)   | 1                   |

| No.   | Name/Value                                    | Description  | Def/FbEq16                     |
|-------|---|--|--------------------------------|
| 26.55 | <a href="#">Oscillation damping frequency</a> | Defines the center frequency of the oscillation damping filter. Set the value according to the number of oscillation peaks in the monitored signal (selected by <a href="#">26.53</a> ) per second.<br><b>Note:</b> Before changing this parameter run-time, disable the oscillation damping output using parameter <a href="#">26.52</a> . Monitor the behavior of <a href="#">26.58</a> before re-enabling the output.   | 31.0 Hz                        |
|       | 0.1 ... 60.0 Hz                               | Center frequency for oscillation damping.  | 10 = 1 Hz                      |
| 26.56 | <a href="#">Oscillation damping phase</a>     | Defines a phase shift for the output of the filter.<br><b>Note:</b> Before changing this parameter run-time, disable the oscillation damping output using parameter <a href="#">26.52</a> . Monitor the behavior of <a href="#">26.58</a> before re-enabling the output.   | 180 deg                        |
|       | 0...360 deg                                   | Phase shift for oscillation damping function output.   | 10 = 1 deg                     |
| 26.57 | <a href="#">Oscillation damping gain</a>      | Defines a gain for the output of the oscillation damping function, ie. how much the output of the filter is amplified before it is added to the torque reference. Oscillation gain is scaled according to the speed controller gain so that changing the gain will not disturb oscillation damping.<br><b>Note:</b> Before changing this parameter run-time, disable the oscillation damping output using parameter <a href="#">26.52</a> . Monitor the behavior of <a href="#">26.58</a> before re-enabling the output. | 1.0%                           |
|       | 0.0 ... 100.0%                                | Gain setting for oscillation damping output.   | 10 = 1%                        |
| 26.58 | <a href="#">Oscillation damping output</a>    | Displays the output of the oscillation damping function. This value is added to the torque reference (as allowed by parameter <a href="#">26.52 Oscillation damping out enable</a> ). This parameter is read-only.   | -                              |
|       | -1600.000 ... 1600.000%                       | Output of the oscillation damping function.  | 10 = 1%                        |
| 26.70 | <a href="#">Torque reference act 1</a>        | Displays the value of torque reference source 1 (selected by parameter <a href="#">26.11 Torque ref1 source</a> ). See the control chain diagram on page <a href="#">571</a> . This parameter is read-only.  | -                              |
|       | -1600.0 ... 1600.0%                           | Value of torque reference source 1.  | See par. <a href="#">46.03</a> |
| 26.71 | <a href="#">Torque reference act 2</a>        | Displays the value of torque reference source 2 (selected by parameter <a href="#">26.12 Torque ref2 source</a> ). See the control chain diagram on page <a href="#">571</a> . This parameter is read-only.  | -                              |
|       | -1600.0 ... 1600.0%                           | Value of torque reference source 2.  | See par. <a href="#">46.03</a> |
| 26.72 | <a href="#">Torque reference act 3</a>        | Displays the torque reference after the function applied by parameter <a href="#">26.13 Torque ref1 function</a> (if any), and after selection ( <a href="#">26.14 Torque ref1/2 selection</a> ). See the control chain diagram on page <a href="#">571</a> . This parameter is read-only.   | -                              |
|       | -1600.0 ... 1600.0%                           | Torque reference after selection.  | See par. <a href="#">46.03</a> |
| 26.73 | <a href="#">Torque reference act 4</a>        | Displays the torque reference after application of reference additive 1. See the control chain diagram on page <a href="#">571</a> . This parameter is read-only.  | -                              |
|       | -1600.0 ... 1600.0%                           | Torque reference after application of reference additive 1.  | See par. <a href="#">46.03</a> |



| No.                                 | Name/Value                           | Description  | Def/FbEq16     |
|-------------------------------------|--------------------------------------|--|----------------|
| 26.74                               | <i>Torque ref ramp out</i>           | Displays the torque reference after limiting and ramping. See the control chain diagram on page 571.<br>This parameter is read-only.                                 | -              |
|                                     | -1600.0 ... 1600.0%                  | Torque reference after limiting and ramping.   | See par. 46.03 |
| 26.75                               | <i>Torque reference act 5</i>        | Displays the torque reference after control mode selection. See the control chain diagram on page 573.<br>This parameter is read-only.                               | -              |
|                                     | -1600.0 ... 1600.0%                  | Torque reference after control mode selection.   | See par. 46.03 |
| 26.76                               | <i>Torque reference act 6</i>        | Displays the torque reference after application of reference additive 2. See the control chain diagram on page 573.<br>This parameter is read-only.                  | -              |
|                                     | -1600.0 ... 1600.0%                  | Torque reference after application of reference additive 2.  | See par. 46.03 |
| 26.77                               | <i>Torque ref add A actual</i>       | Displays the value of the source of torque reference additive 2. See the control chain diagram on page 573.<br>This parameter is read-only.                          | -              |
|                                     | -1600.0 ... 1600.0%                  | Torque reference additive 2.   | See par. 46.03 |
| 26.78                               | <i>Torque ref add B actual</i>       | Displays the value of torque reference additive 2 before it is added to torque reference. See the control chain diagram on page 573.<br>This parameter is read-only. | -              |
|                                     | -1600.0 ... 1600.0%                  | Torque reference additive 2.   | See par. 46.03 |
| 26.81                               | <i>Rush control gain</i>             | Rush controller gain term. See section <i>Rush control</i> (page 48).  | 10.0           |
|                                     | 0.0 ... 10000.0                      | Rush controller gain (0.0 = disabled).   | 1 = 1          |
| 26.82                               | <i>Rush control integration time</i> | Rush controller integration time term.   | 2.0 s          |
|                                     | 0.0 ... 10.0 s                       | Rush controller integration time (0.0 = disabled).   | 1 = 1 s        |
| <b>28 Frequency reference chain</b> |                                      | Settings for the frequency reference chain. See the control chain diagrams on pages 576 and 577.   |                |
| 28.01                               | <i>Frequency ref ramp input</i>      | Displays the used frequency reference before ramping. See the control chain diagram on page 577.<br>This parameter is read-only.                                     | -              |
|                                     | -500.00 ... 500.00 Hz                | Frequency reference before ramping.  | See par. 46.02 |
| 28.02                               | <i>Frequency ref ramp output</i>     | Displays the final frequency reference (after selection, limitation and ramping). See the control chain diagram on page 577.<br>This parameter is read-only.         | -              |
|                                     | -500.00 ... 500.00 Hz                | Final frequency reference.   | See par. 46.02 |

| No.                        | Name/Value   | Description  | Def/FbEq16 |
|----------------------------|--|--|------------|
| 28.11                      | Frequency ref1 source  | <p>Selects frequency reference source 1.</p> <p>Two signal sources can be defined by this parameter and <a href="#">28.12 Frequency ref2 source</a>. A digital source selected by <a href="#">28.14 Frequency ref1/2 selection</a> can be used to switch between the two sources, or a mathematical function (<a href="#">28.13 Frequency ref1 function</a>) applied to the two signals to create the reference.</p> | Zero       |
|                            |  |  |            |
| Zero                       | None.  | 0  |            |
| AI1 scaled                 | <a href="#">12.12 AI1 scaled value</a> (see page 158).   | 1  |            |
| AI2 scaled                 | <a href="#">12.22 AI2 scaled value</a> (see page 160).   | 2  |            |
| FB A ref1                  | <a href="#">03.05 FB A reference 1</a> (see page 119).   | 4  |            |
| FB A ref2                  | <a href="#">03.06 FB A reference 2</a> (see page 120).   | 5  |            |
| EFB ref1                   | <a href="#">03.09 EFB reference 1</a> (see page 120).  | 8  |            |
| EFB ref2                   | <a href="#">03.10 EFB reference 2</a> (see page 120).  | 9  |            |
| DDCS ctrl ref1             | <a href="#">03.11 DDCS controller ref 1</a> (see page 120).  | 10   |            |
| DDCS ctrl ref2             | <a href="#">03.12 DDCS controller ref 2</a> (see page 120).  | 11   |            |
| M/F reference 1            | <a href="#">03.13 M/F or D2D ref1</a> (see page 120).  | 12   |            |
| M/F reference 2            | <a href="#">03.14 M/F or D2D ref2</a> (see page 120).  | 13   |            |
| Motor potentiometer        | <a href="#">22.80 Motor potentiometer ref act</a> (output of the motor potentiometer).   | 15   |            |
| PID                        | <a href="#">40.01 Process PID output actual</a> (output of the process PID controller).  | 16   |            |
| Control panel (ref saved)  | Control panel reference, with initial value from last-used panel reference. See section <a href="#">Using the control panel as an external control source</a> (page 21).       | 18   |            |
| Control panel (ref copied) | Control panel reference, with initial value from previous source or actual value. See section <a href="#">Using the control panel as an external control source</a> (page 21). | 19   |            |
| Other                      | Source selection (see <a href="#">Terms and abbreviations</a> on page 112).  | -  |            |
| 28.12                      | Frequency ref2 source  | <p>Selects frequency reference source 2.</p> <p>For the selections, and a diagram of reference source selection, see parameter <a href="#">28.11 Frequency ref1 source</a>.</p>  | Zero       |



| No.   | Name/Value                        | Description   | Def/FbEq16                        |
|-------|-----------------------------------|---|-----------------------------------|
| 28.13 | <i>Frequency ref1 function</i>    | Selects a mathematical function between the reference sources selected by parameters <a href="#">28.11 Frequency ref1 source</a> and <a href="#">28.12 Frequency ref2 source</a> . See diagram at <a href="#">28.11 Frequency ref1 source</a> . | <i>Ref1</i>                       |
|       | Ref1                              | Signal selected by <a href="#">28.11 Frequency ref1 source</a> is used as frequency reference 1 as such (no function applied).  | 0                                 |
|       | Add (ref1 + ref2)                 | The sum of the reference sources is used as frequency reference 1.  | 1                                 |
|       | Sub (ref1 - ref2)                 | The subtraction ( <a href="#">[28.11 Frequency ref1 source]</a> - <a href="#">[28.12 Frequency ref2 source]</a> ) of the reference sources is used as frequency reference 1.  | 2                                 |
|       | Mul (ref1 × ref2)                 | The multiplication of the reference sources is used as frequency reference 1.   | 3                                 |
|       | Min (ref1, ref2)                  | The smaller of the reference sources is used as frequency reference 1.  | 4                                 |
|       | Max (ref1, ref2)                  | The greater of the reference sources is used as frequency reference 1.  | 5                                 |
| 28.14 | <i>Frequency ref1/2 selection</i> | Configures the selection between frequency references 1 and 2. See diagram at <a href="#">28.11 Frequency ref1 source</a> .<br>0 = Frequency reference 1<br>1 = Frequency reference 2   | <i>Follow Ext1/Ext2 selection</i> |
|       | Frequency reference 1             | 0.  | 0                                 |
|       | Frequency reference 2             | 1.  | 1                                 |
|       | Follow Ext1/Ext2 selection        | Frequency reference 1 is used when external control location EXT1 is active. Frequency reference 2 is used when external control location EXT2 is active.<br>See also parameter <a href="#">19.11 Ext1/Ext2 selection</a> .                     | 2                                 |
|       | DI1                               | Digital input DI1 ( <a href="#">10.02 DI delayed status</a> , bit 0).   | 3                                 |
|       | DI2                               | Digital input DI2 ( <a href="#">10.02 DI delayed status</a> , bit 1).   | 4                                 |
|       | DI3                               | Digital input DI3 ( <a href="#">10.02 DI delayed status</a> , bit 2).   | 5                                 |
|       | DI4                               | Digital input DI4 ( <a href="#">10.02 DI delayed status</a> , bit 3).   | 6                                 |
|       | DI5                               | Digital input DI5 ( <a href="#">10.02 DI delayed status</a> , bit 4).   | 7                                 |
|       | DI6                               | Digital input DI6 ( <a href="#">10.02 DI delayed status</a> , bit 5).   | 8                                 |
|       | <i>Other [bit]</i>                | Source selection (see <a href="#">Terms and abbreviations</a> on page <a href="#">112</a> ).  | -                                 |



| No.  | Name/Value                                   | Description  | Def/FbEq16                                   |  |  |                           |                    |  |   |                  |  |   |   |                      |   |   |   |                      |   |   |   |                      |   |   |   |                      |   |   |   |                      |   |   |   |                      |   |   |   |                      |  |
|--|--|--|--|--|--|---------------------------|--------------------|--|---|------------------|--|---|---|----------------------|---|---|---|----------------------|---|---|---|----------------------|---|---|---|----------------------|---|---|---|----------------------|---|---|---|----------------------|---|---|---|----------------------|--|
| 28.21  | <i>Constant frequency function</i>           | Determines how constant frequencies are selected, and whether the rotation direction signal is considered or not when applying a constant frequency.   | 0000b  |  |  |                           |                    |  |   |                  |  |   |   |                      |   |   |   |                      |   |   |   |                      |   |   |   |                      |   |   |   |                      |   |   |   |                      |   |   |   |                      |  |
|  |  | <table border="1"> <thead> <tr> <th>Bit</th> <th>Name</th> <th>Information</th> </tr> </thead> <tbody> <tr> <td>0</td> <td>Constant freq mode</td> <td> <p>1 = Packed: 7 constant frequencies are selectable using the three sources defined by parameters <a href="#">28.22</a>, <a href="#">28.23</a> and <a href="#">28.24</a>.</p> <p>0 = Separate: Constant frequencies 1, 2 and 3 are separately activated by the sources defined by parameters <a href="#">28.22</a>, <a href="#">28.23</a> and <a href="#">28.24</a> respectively. In case of conflict, the constant frequency with the smaller number takes priority.</p> </td> </tr> <tr> <td>1</td> <td>Direction enable</td> <td> <p>1 = Start dir: To determine running direction for a constant frequency, the sign of the constant frequency setting (parameters <a href="#">28.26...28.32</a>) is multiplied by the direction signal (forward: +1, reverse: -1). This effectively allows the drive to have 14 (7 forward, 7 reverse) constant frequencies if all values in <a href="#">28.26...28.32</a> are positive.</p> <p> <b>WARNING:</b> If the direction signal is reverse and the active constant frequency is negative, the drive will run in the forward direction.</p> <p>0 = According to Par: The running direction for the constant frequency is determined by the sign of the constant speed setting (parameters <a href="#">28.26...28.32</a>).</p> </td> </tr> </tbody> </table> | Bit  | Name   | Information                                  | 0                         | Constant freq mode | <p>1 = Packed: 7 constant frequencies are selectable using the three sources defined by parameters <a href="#">28.22</a>, <a href="#">28.23</a> and <a href="#">28.24</a>.</p> <p>0 = Separate: Constant frequencies 1, 2 and 3 are separately activated by the sources defined by parameters <a href="#">28.22</a>, <a href="#">28.23</a> and <a href="#">28.24</a> respectively. In case of conflict, the constant frequency with the smaller number takes priority.</p> | 1 | Direction enable | <p>1 = Start dir: To determine running direction for a constant frequency, the sign of the constant frequency setting (parameters <a href="#">28.26...28.32</a>) is multiplied by the direction signal (forward: +1, reverse: -1). This effectively allows the drive to have 14 (7 forward, 7 reverse) constant frequencies if all values in <a href="#">28.26...28.32</a> are positive.</p> <p> <b>WARNING:</b> If the direction signal is reverse and the active constant frequency is negative, the drive will run in the forward direction.</p> <p>0 = According to Par: The running direction for the constant frequency is determined by the sign of the constant speed setting (parameters <a href="#">28.26...28.32</a>).</p> |   |   |                      |   |   |   |                      |   |   |   |                      |   |   |   |                      |   |   |   |                      |   |   |   |                      |   |   |   |                      |  |
| Bit  | Name   | Information  |  |  |  |                           |                    |  |   |                  |  |   |   |                      |   |   |   |                      |   |   |   |                      |   |   |   |                      |   |   |   |                      |   |   |   |                      |   |   |   |                      |  |
| 0  | Constant freq mode                           | <p>1 = Packed: 7 constant frequencies are selectable using the three sources defined by parameters <a href="#">28.22</a>, <a href="#">28.23</a> and <a href="#">28.24</a>.</p> <p>0 = Separate: Constant frequencies 1, 2 and 3 are separately activated by the sources defined by parameters <a href="#">28.22</a>, <a href="#">28.23</a> and <a href="#">28.24</a> respectively. In case of conflict, the constant frequency with the smaller number takes priority.</p>   |  |  |  |                           |                    |  |   |                  |  |   |   |                      |   |   |   |                      |   |   |   |                      |   |   |   |                      |   |   |   |                      |   |   |   |                      |   |   |   |                      |  |
| 1  | Direction enable                             | <p>1 = Start dir: To determine running direction for a constant frequency, the sign of the constant frequency setting (parameters <a href="#">28.26...28.32</a>) is multiplied by the direction signal (forward: +1, reverse: -1). This effectively allows the drive to have 14 (7 forward, 7 reverse) constant frequencies if all values in <a href="#">28.26...28.32</a> are positive.</p> <p> <b>WARNING:</b> If the direction signal is reverse and the active constant frequency is negative, the drive will run in the forward direction.</p> <p>0 = According to Par: The running direction for the constant frequency is determined by the sign of the constant speed setting (parameters <a href="#">28.26...28.32</a>).</p>   |  |  |  |                           |                    |  |   |                  |  |   |   |                      |   |   |   |                      |   |   |   |                      |   |   |   |                      |   |   |   |                      |   |   |   |                      |   |   |   |                      |  |
|  | 0000b...0011b                                | Constant frequency configuration word.   | 1 = 1  |  |  |                           |                    |  |   |                  |  |   |   |                      |   |   |   |                      |   |   |   |                      |   |   |   |                      |   |   |   |                      |   |   |   |                      |   |   |   |                      |  |
| 28.22  | <i>Constant frequency sel1</i>               | <p>When bit 0 of parameter <a href="#">28.21 Constant frequency function</a> is 0 (Separate), selects a source that activates constant frequency 1.</p> <p>When bit 0 of parameter <a href="#">28.21 Constant frequency function</a> is 1 (Packed), this parameter and parameters <a href="#">28.23 Constant frequency sel2</a> and <a href="#">28.24 Constant frequency sel3</a> select three sources whose states activate constant frequencies as follows:</p>  | <i>Not selected</i>                          |  |  |                           |                    |  |   |                  |  |   |   |                      |   |   |   |                      |   |   |   |                      |   |   |   |                      |   |   |   |                      |   |   |   |                      |   |   |   |                      |  |
|  |  | <table border="1"> <thead> <tr> <th>Source defined by par. <a href="#">28.22</a></th> <th>Source defined by par. <a href="#">28.23</a></th> <th>Source defined by par. <a href="#">28.24</a></th> <th>Constant frequency active</th> </tr> </thead> <tbody> <tr> <td>0</td> <td>0</td> <td>0</td> <td>None</td> </tr> <tr> <td>1</td> <td>0</td> <td>0</td> <td>Constant frequency 1</td> </tr> <tr> <td>0</td> <td>1</td> <td>0</td> <td>Constant frequency 2</td> </tr> <tr> <td>1</td> <td>1</td> <td>0</td> <td>Constant frequency 3</td> </tr> <tr> <td>0</td> <td>0</td> <td>1</td> <td>Constant frequency 4</td> </tr> <tr> <td>1</td> <td>0</td> <td>1</td> <td>Constant frequency 5</td> </tr> <tr> <td>0</td> <td>1</td> <td>1</td> <td>Constant frequency 6</td> </tr> <tr> <td>1</td> <td>1</td> <td>1</td> <td>Constant frequency 7</td> </tr> </tbody> </table>  | Source defined by par. <a href="#">28.22</a> | Source defined by par. <a href="#">28.23</a> | Source defined by par. <a href="#">28.24</a> | Constant frequency active | 0                  | 0  | 0 | None             | 1  | 0 | 0 | Constant frequency 1 | 0 | 1 | 0 | Constant frequency 2 | 1 | 1 | 0 | Constant frequency 3 | 0 | 0 | 1 | Constant frequency 4 | 1 | 0 | 1 | Constant frequency 5 | 0 | 1 | 1 | Constant frequency 6 | 1 | 1 | 1 | Constant frequency 7 |  |
| Source defined by par. <a href="#">28.22</a> | Source defined by par. <a href="#">28.23</a> | Source defined by par. <a href="#">28.24</a>   | Constant frequency active                    |  |  |                           |                    |  |   |                  |  |   |   |                      |   |   |   |                      |   |   |   |                      |   |   |   |                      |   |   |   |                      |   |   |   |                      |   |   |   |                      |  |
| 0  | 0  | 0  | None   |  |  |                           |                    |  |   |                  |  |   |   |                      |   |   |   |                      |   |   |   |                      |   |   |   |                      |   |   |   |                      |   |   |   |                      |   |   |   |                      |  |
| 1  | 0  | 0  | Constant frequency 1                         |  |  |                           |                    |  |   |                  |  |   |   |                      |   |   |   |                      |   |   |   |                      |   |   |   |                      |   |   |   |                      |   |   |   |                      |   |   |   |                      |  |
| 0  | 1  | 0  | Constant frequency 2                         |  |  |                           |                    |  |   |                  |  |   |   |                      |   |   |   |                      |   |   |   |                      |   |   |   |                      |   |   |   |                      |   |   |   |                      |   |   |   |                      |  |
| 1  | 1  | 0  | Constant frequency 3                         |  |  |                           |                    |  |   |                  |  |   |   |                      |   |   |   |                      |   |   |   |                      |   |   |   |                      |   |   |   |                      |   |   |   |                      |   |   |   |                      |  |
| 0  | 0  | 1  | Constant frequency 4                         |  |  |                           |                    |  |   |                  |  |   |   |                      |   |   |   |                      |   |   |   |                      |   |   |   |                      |   |   |   |                      |   |   |   |                      |   |   |   |                      |  |
| 1  | 0  | 1  | Constant frequency 5                         |  |  |                           |                    |  |   |                  |  |   |   |                      |   |   |   |                      |   |   |   |                      |   |   |   |                      |   |   |   |                      |   |   |   |                      |   |   |   |                      |  |
| 0  | 1  | 1  | Constant frequency 6                         |  |  |                           |                    |  |   |                  |  |   |   |                      |   |   |   |                      |   |   |   |                      |   |   |   |                      |   |   |   |                      |   |   |   |                      |   |   |   |                      |  |
| 1  | 1  | 1  | Constant frequency 7                         |  |  |                           |                    |  |   |                  |  |   |   |                      |   |   |   |                      |   |   |   |                      |   |   |   |                      |   |   |   |                      |   |   |   |                      |   |   |   |                      |  |
|  | Not selected                                 | 0.   | 0  |  |  |                           |                    |  |   |                  |  |   |   |                      |   |   |   |                      |   |   |   |                      |   |   |   |                      |   |   |   |                      |   |   |   |                      |   |   |   |                      |  |
|  | Selected                                     | 1.   | 1  |  |  |                           |                    |  |   |                  |  |   |   |                      |   |   |   |                      |   |   |   |                      |   |   |   |                      |   |   |   |                      |   |   |   |                      |   |   |   |                      |  |
|  | DI1  | Digital input DI1 ( <a href="#">10.02 DI delayed status</a> , bit 0).  | 2  |  |  |                           |                    |  |   |                  |  |   |   |                      |   |   |   |                      |   |   |   |                      |   |   |   |                      |   |   |   |                      |   |   |   |                      |   |   |   |                      |  |
|  | DI2  | Digital input DI2 ( <a href="#">10.02 DI delayed status</a> , bit 1).  | 3  |  |  |                           |                    |  |   |                  |  |   |   |                      |   |   |   |                      |   |   |   |                      |   |   |   |                      |   |   |   |                      |   |   |   |                      |   |   |   |                      |  |
|  | DI3  | Digital input DI3 ( <a href="#">10.02 DI delayed status</a> , bit 2).  | 4  |  |  |                           |                    |  |   |                  |  |   |   |                      |   |   |   |                      |   |   |   |                      |   |   |   |                      |   |   |   |                      |   |   |   |                      |   |   |   |                      |  |
|  | DI4  | Digital input DI4 ( <a href="#">10.02 DI delayed status</a> , bit 3).  | 5  |  |  |                           |                    |  |   |                  |  |   |   |                      |   |   |   |                      |   |   |   |                      |   |   |   |                      |   |   |   |                      |   |   |   |                      |   |   |   |                      |  |
|  | DI5  | Digital input DI5 ( <a href="#">10.02 DI delayed status</a> , bit 4).  | 6  |  |  |                           |                    |  |   |                  |  |   |   |                      |   |   |   |                      |   |   |   |                      |   |   |   |                      |   |   |   |                      |   |   |   |                      |   |   |   |                      |  |

## 250 Parameters

| No.                   | Name/Value                              | Description   | Def/FbEq16                     |
|-----------------------|---|---|--------------------------------|
|                       | DI6                                     | Digital input DI6 ( <a href="#">10.02 DI delayed status</a> , bit 5).   | 7                              |
|                       | DIO1                                    | Digital input/output DIO1 ( <a href="#">11.02 DIO delayed status</a> , bit 0).  | 10                             |
|                       | DIO2                                    | Digital input/output DIO2 ( <a href="#">11.02 DIO delayed status</a> , bit 1).  | 11                             |
|                       | <i>Other [bit]</i>                      | Source selection (see <a href="#">Terms and abbreviations</a> on page 112).   | -                              |
| <a href="#">28.23</a> | <a href="#">Constant frequency sel2</a> | When bit 0 of parameter <a href="#">28.21 Constant frequency function</a> is 0 (Separate), selects a source that activates constant frequency 2.<br>When bit 0 of parameter <a href="#">28.21 Constant frequency function</a> is 1 (Packed), this parameter and parameters <a href="#">28.22 Constant frequency sel1</a> and <a href="#">28.24 Constant frequency sel3</a> select three sources that are used to activate constant frequencies. See table at parameter <a href="#">28.22 Constant frequency sel1</a> .<br>For the selections, see parameter <a href="#">28.22 Constant frequency sel1</a> . | <i>Not selected</i>            |
| <a href="#">28.24</a> | <a href="#">Constant frequency sel3</a> | When bit 0 of parameter <a href="#">28.21 Constant frequency function</a> is 0 (Separate), selects a source that activates constant frequency 3.<br>When bit 0 of parameter <a href="#">28.21 Constant frequency function</a> is 1 (Packed), this parameter and parameters <a href="#">28.22 Constant frequency sel1</a> and <a href="#">28.23 Constant frequency sel2</a> select three sources that are used to activate constant frequencies. See table at parameter <a href="#">28.22 Constant frequency sel1</a> .<br>For the selections, see parameter <a href="#">28.22 Constant frequency sel1</a> . | <i>Not selected</i>            |
| <a href="#">28.26</a> | <a href="#">Constant frequency 1</a>    | Defines constant frequency 1 (the frequency the motor will turn when constant frequency 1 is selected).   | 0.00 Hz                        |
|                       | -500.00 ... 500.00 Hz                   | Constant frequency 1.   | See par. <a href="#">46.02</a> |
| <a href="#">28.27</a> | <a href="#">Constant frequency 2</a>    | Defines constant frequency 2.   | 0.00 Hz                        |
|                       | -500.00 ... 500.00 Hz                   | Constant frequency 2.   | See par. <a href="#">46.02</a> |
| <a href="#">28.28</a> | <a href="#">Constant frequency 3</a>    | Defines constant frequency 3.   | 0.00 Hz                        |
|                       | -500.00 ... 500.00 Hz                   | Constant frequency 3.   | See par. <a href="#">46.02</a> |
| <a href="#">28.29</a> | <a href="#">Constant frequency 4</a>    | Defines constant frequency 4.   | 0.00 Hz                        |
|                       | -500.00 ... 500.00 Hz                   | Constant frequency 4.   | See par. <a href="#">46.02</a> |
| <a href="#">28.30</a> | <a href="#">Constant frequency 5</a>    | Defines constant frequency 5.   | 0.00 Hz                        |
|                       | -500.00 ... 500.00 Hz                   | Constant frequency 5.   | See par. <a href="#">46.02</a> |
| <a href="#">28.31</a> | <a href="#">Constant frequency 6</a>    | Defines constant frequency 6.   | 0.00 Hz                        |
|                       | -500.00 ... 500.00 Hz                   | Constant frequency 6.   | See par. <a href="#">46.02</a> |

| No.  | Name/Value                         | Description   | Def/FbEq16                     |     |      |             |   |        |   |   |   |           |   |  |
|--|------------------------------------|---|--------------------------------|-----|------|-------------|---|--------|---|---|---|-----------|---|--|
| 28.32  | <i>Constant frequency 7</i>        | Defines constant frequency 7.   | 0.00 Hz                        |     |      |             |   |        |   |   |   |           |   |  |
|  | -500.00 ... 500.00 Hz              | Constant frequency 7.   | See par. <a href="#">46.02</a> |     |      |             |   |        |   |   |   |           |   |  |
| 28.41  | <i>Frequency ref safe</i>          | Defines a safe frequency reference value that is used with supervision functions such as <ul style="list-style-type: none"> <li>• <a href="#">12.03 AI supervision function</a></li> <li>• <a href="#">49.05 Communication loss action</a></li> <li>• <a href="#">50.02 FBA A comm loss func</a></li> <li>• <a href="#">50.32 FBA B comm loss func</a></li> <li>• <a href="#">58.14 Communication loss action</a>.</li> </ul> | 0.00 Hz                        |     |      |             |   |        |   |   |   |           |   |  |
|  | -500.00 ... 500.00 Hz              | Safe frequency reference.   | See par. <a href="#">46.02</a> |     |      |             |   |        |   |   |   |           |   |  |
| 28.51  | <i>Critical frequency function</i> | Enables/disables the critical frequencies function. Also determines whether the specified ranges are effective in both rotating directions or not.<br>See also section <a href="#">Critical speeds/frequencies</a> (page 43).   | 0000b                          |     |      |             |   |        |   |   |   |           |   |  |
| <table border="1"> <thead> <tr> <th>Bit</th> <th>Name</th> <th>Information</th> </tr> </thead> <tbody> <tr> <td rowspan="2">0</td> <td rowspan="2">Enable</td> <td>1 = Enable: Critical frequencies enabled.</td> </tr> <tr> <td>0 = Disable: Critical frequencies disabled.</td> </tr> <tr> <td rowspan="2">1</td> <td rowspan="2">Sign mode</td> <td>1 = According to par: The signs of parameters <a href="#">28.52...28.57</a> are taken into account.</td> </tr> <tr> <td>0 = Absolute: Parameters <a href="#">28.52...28.57</a> are handled as absolute values. Each range is effective in both directions of rotation.</td> </tr> </tbody> </table> |                                    |   |                                | Bit | Name | Information | 0 | Enable | 1 = Enable: Critical frequencies enabled. | 0 = Disable: Critical frequencies disabled. | 1 | Sign mode | 1 = According to par: The signs of parameters <a href="#">28.52...28.57</a> are taken into account. | 0 = Absolute: Parameters <a href="#">28.52...28.57</a> are handled as absolute values. Each range is effective in both directions of rotation. |
| Bit  | Name                               | Information   |                                |     |      |             |   |        |   |   |   |           |   |  |
| 0  | Enable                             | 1 = Enable: Critical frequencies enabled.   |                                |     |      |             |   |        |   |   |   |           |   |  |
|  |                                    | 0 = Disable: Critical frequencies disabled.   |                                |     |      |             |   |        |   |   |   |           |   |  |
| 1  | Sign mode                          | 1 = According to par: The signs of parameters <a href="#">28.52...28.57</a> are taken into account.   |                                |     |      |             |   |        |   |   |   |           |   |  |
|  |                                    | 0 = Absolute: Parameters <a href="#">28.52...28.57</a> are handled as absolute values. Each range is effective in both directions of rotation.  |                                |     |      |             |   |        |   |   |   |           |   |  |
|  | 0000b...0011b                      | Critical frequencies configuration word.  | 1 = 1                          |     |      |             |   |        |   |   |   |           |   |  |
| 28.52  | <i>Critical frequency 1 low</i>    | Defines the low limit for critical frequency 1.<br><b>Note:</b> This value must be less than or equal to the value of <a href="#">28.53 Critical frequency 1 high</a> .   | 0.00 Hz                        |     |      |             |   |        |   |   |   |           |   |  |
|  | -500.00 ... 500.00 Hz              | Low limit for critical frequency 1.   | See par. <a href="#">46.02</a> |     |      |             |   |        |   |   |   |           |   |  |
| 28.53  | <i>Critical frequency 1 high</i>   | Defines the high limit for critical frequency 1.<br><b>Note:</b> This value must be greater than or equal to the value of <a href="#">28.52 Critical frequency 1 low</a> .  | 0.00 Hz                        |     |      |             |   |        |   |   |   |           |   |  |
|  | -500.00 ... 500.00 Hz              | High limit for critical frequency 1.  | See par. <a href="#">46.02</a> |     |      |             |   |        |   |   |   |           |   |  |
| 28.54  | <i>Critical frequency 2 low</i>    | Defines the low limit for critical frequency 2.<br><b>Note:</b> This value must be less than or equal to the value of <a href="#">28.55 Critical frequency 2 high</a> .   | 0.00 Hz                        |     |      |             |   |        |   |   |   |           |   |  |
|  | -500.00 ... 500.00 Hz              | Low limit for critical frequency 2.   | See par. <a href="#">46.02</a> |     |      |             |   |        |   |   |   |           |   |  |
| 28.55  | <i>Critical frequency 2 high</i>   | Defines the high limit for critical frequency 2.<br><b>Note:</b> This value must be greater than or equal to the value of <a href="#">28.54 Critical frequency 2 low</a> .  | 0.00 Hz                        |     |      |             |   |        |   |   |   |           |   |  |
|  | -500.00 ... 500.00 Hz              | High limit for critical frequency 2.  | See par. <a href="#">46.02</a> |     |      |             |   |        |   |   |   |           |   |  |

## 252 Parameters

| No.   | Name/Value                       | Description   | Def/FbEq16                     |
|-------|----------------------------------|---|--------------------------------|
| 28.56 | <i>Critical frequency 3 low</i>  | Defines the low limit for critical frequency 3.<br><b>Note:</b> This value must be less than or equal to the value of <a href="#">28.57 Critical frequency 3 high</a> .   | 0.00 Hz                        |
|       | -500.00 ... 500.00 Hz            | Low limit for critical frequency 3.   | See par. <a href="#">46.02</a> |
| 28.57 | <i>Critical frequency 3 high</i> | Defines the high limit for critical frequency 3.<br><b>Note:</b> This value must be greater than or equal to the value of <a href="#">28.56 Critical frequency 3 low</a> .  | 0.00 Hz                        |
|       | -500.00 ... 500.00 Hz            | High limit for critical frequency 3.  | See par. <a href="#">46.02</a> |
| 28.71 | <i>Freq ramp set selection</i>   | Selects a source that switches between the two sets of acceleration/deceleration times defined by parameters <a href="#">28.72...28.75</a> .<br>0 = Acceleration time 1 and deceleration time 1 are in force<br>1 = Acceleration time 2 and deceleration time 2 are in force  | <i>Acc/Dec time 1</i>          |
|       | Acc/Dec time 1                   | 0.  | 0                              |
|       | Acc/Dec time 2                   | 1.  | 1                              |
|       | DI1                              | Digital input DI1 ( <a href="#">10.02 DI delayed status</a> , bit 0).   | 2                              |
|       | DI2                              | Digital input DI2 ( <a href="#">10.02 DI delayed status</a> , bit 1).   | 3                              |
|       | DI3                              | Digital input DI3 ( <a href="#">10.02 DI delayed status</a> , bit 2).   | 4                              |
|       | DI4                              | Digital input DI4 ( <a href="#">10.02 DI delayed status</a> , bit 3).   | 5                              |
|       | DI5                              | Digital input DI5 ( <a href="#">10.02 DI delayed status</a> , bit 4).   | 6                              |
|       | DI6                              | Digital input DI6 ( <a href="#">10.02 DI delayed status</a> , bit 5).   | 7                              |
|       | DIO1                             | Digital input/output DIO1 ( <a href="#">11.02 DIO delayed status</a> , bit 0).  | 10                             |
|       | DIO2                             | Digital input/output DIO2 ( <a href="#">11.02 DIO delayed status</a> , bit 1).  | 11                             |
|       | <i>Other [bit]</i>               | Source selection (see <a href="#">Terms and abbreviations</a> on page 112).   | -                              |
| 28.72 | <i>Freq acceleration time 1</i>  | Defines acceleration time 1 as the time required for the frequency to change from zero to the frequency defined by parameter <a href="#">46.02 Frequency scaling</a> (not to parameter <a href="#">30.14 Maximum frequency</a> ).<br>If the reference increases faster than the set acceleration rate, the motor will follow the acceleration rate.<br>If the reference increases slower than the set acceleration rate, the motor frequency will follow the reference.<br>If the acceleration time is set too short, the drive will automatically prolong the acceleration in order not to exceed the drive torque limits. | 20.000 s                       |
|       | 0.000 ... 1800.000 s             | Acceleration time 1.  | 10 = 1 s                       |
| 28.73 | <i>Freq deceleration time 1</i>  | Defines deceleration time 1 as the time required for the frequency to change from the frequency defined by parameter <a href="#">46.02 Frequency scaling</a> (not from parameter <a href="#">30.14 Maximum frequency</a> ) to zero.<br>If there is any doubt about the deceleration time being too short, ensure that DC overvoltage control ( <a href="#">30.30 Overvoltage control</a> ) is on.<br><b>Note:</b> If a short deceleration time is needed for a high inertia application, the drive should be equipped with braking equipment such as a brake chopper and brake resistor.                                    | 20.000 s                       |
|       | 0.000 ... 1800.000 s             | Deceleration time 1.  | 10 = 1 s                       |



| No.   | Name/Value                        | Description  | Def/FbEq16                     |
|-------|-----------------------------------|--|--------------------------------|
| 28.74 | <i>Freq acceleration time 2</i>   | Defines acceleration time 2. See parameter <a href="#">28.72 Freq acceleration time 1</a> .  | 60.000 s                       |
|       | 0.000 ... 1800.000 s              | Acceleration time 2.   | 10 = 1 s                       |
| 28.75 | <i>Freq deceleration time 2</i>   | Defines deceleration time 2. See parameter <a href="#">28.73 Freq deceleration time 1</a> .  | 60.000 s                       |
|       | 0.000 ... 1800.000 s              | Deceleration time 2.   | 10 = 1 s                       |
| 28.76 | <i>Freq ramp in zero source</i>   | Selects a source that forces the frequency reference to zero.<br>0 = Force frequency reference to zero<br>1 = Normal operation   | <i>Inactive</i>                |
|       | Active                            | 0.   | 0                              |
|       | Inactive                          | 1.   | 1                              |
|       | DI1                               | Digital input DI1 ( <a href="#">10.02 DI delayed status</a> , bit 0).  | 2                              |
|       | DI2                               | Digital input DI2 ( <a href="#">10.02 DI delayed status</a> , bit 1).  | 3                              |
|       | DI3                               | Digital input DI3 ( <a href="#">10.02 DI delayed status</a> , bit 2).  | 4                              |
|       | DI4                               | Digital input DI4 ( <a href="#">10.02 DI delayed status</a> , bit 3).  | 5                              |
|       | DI5                               | Digital input DI5 ( <a href="#">10.02 DI delayed status</a> , bit 4).  | 6                              |
|       | DI6                               | Digital input DI6 ( <a href="#">10.02 DI delayed status</a> , bit 5).  | 7                              |
|       | DIO1                              | Digital input/output DIO1 ( <a href="#">11.02 DIO delayed status</a> , bit 0).   | 10                             |
|       | DIO2                              | Digital input/output DIO2 ( <a href="#">11.02 DIO delayed status</a> , bit 1).   | 11                             |
|       | <i>Other [bit]</i>                | Source selection (see <a href="#">Terms and abbreviations</a> on page 112).  | -                              |
| 28.77 | <i>Freq ramp hold</i>             | Selects a source that forces the output of the frequency ramp generator to actual frequency value.<br>0 = Force ramp output to actual frequency<br>1 = Normal operation                                  | <i>Inactive</i>                |
|       | Active                            | 0.   | 0                              |
|       | Inactive                          | 1.   | 1                              |
|       | DI1                               | Digital input DI1 ( <a href="#">10.02 DI delayed status</a> , bit 0).  | 2                              |
|       | DI2                               | Digital input DI2 ( <a href="#">10.02 DI delayed status</a> , bit 1).  | 3                              |
|       | DI3                               | Digital input DI3 ( <a href="#">10.02 DI delayed status</a> , bit 2).  | 4                              |
|       | DI4                               | Digital input DI4 ( <a href="#">10.02 DI delayed status</a> , bit 3).  | 5                              |
|       | DI5                               | Digital input DI5 ( <a href="#">10.02 DI delayed status</a> , bit 4).  | 6                              |
|       | DI6                               | Digital input DI6 ( <a href="#">10.02 DI delayed status</a> , bit 5).  | 7                              |
|       | DIO1                              | Digital input/output DIO1 ( <a href="#">11.02 DIO delayed status</a> , bit 0).   | 10                             |
|       | DIO2                              | Digital input/output DIO2 ( <a href="#">11.02 DIO delayed status</a> , bit 1).   | 11                             |
|       | <i>Other [bit]</i>                | Source selection (see <a href="#">Terms and abbreviations</a> on page 112).  | -                              |
| 28.78 | <i>Freq ramp output balancing</i> | Defines a reference for frequency ramp balancing. The output of the ramp generator is forced to this value when balancing is enabled by parameter <a href="#">28.79 Freq ramp out balancing enable</a> . | 0.00 Hz                        |
|       | -500.00 ... 500.00 Hz             | Frequency ramp balancing reference.  | See par. <a href="#">46.02</a> |

## 254 Parameters







| No.   | Name/Value                            | Description   | Def/FbEq16                     |
|-------|---------------------------------------|---|--------------------------------|
| 28.79 | <i>Freq ramp out balancing enable</i> | Selects the source for enabling/disabling speed ramp balancing. See parameter <a href="#">28.78 Freq ramp output balancing</a> .<br>0 = Disabled<br>1 = Enabled   | <i>Not selected</i>            |
|       | Not selected                          | 0.  |                                |
|       | Selected                              | 1.  |                                |
|       | DI1                                   | Digital input DI1 ( <a href="#">10.02 DI delayed status</a> , bit 0).   | 2                              |
|       | DI2                                   | Digital input DI2 ( <a href="#">10.02 DI delayed status</a> , bit 1).   | 3                              |
|       | DI3                                   | Digital input DI3 ( <a href="#">10.02 DI delayed status</a> , bit 2).   | 4                              |
|       | DI4                                   | Digital input DI4 ( <a href="#">10.02 DI delayed status</a> , bit 3).   | 5                              |
|       | DI5                                   | Digital input DI5 ( <a href="#">10.02 DI delayed status</a> , bit 4).   | 6                              |
|       | DI6                                   | Digital input DI6 ( <a href="#">10.02 DI delayed status</a> , bit 5).   | 7                              |
|       | DIO1                                  | Digital input/output DIO1 ( <a href="#">11.02 DIO delayed status</a> , bit 0).  | 10                             |
|       | DIO2                                  | Digital input/output DIO2 ( <a href="#">11.02 DIO delayed status</a> , bit 1).  | 11                             |
|       | <i>Other [bit]</i>                    | Source selection (see <a href="#">Terms and abbreviations</a> on page 112).   | -                              |
| 28.90 | <i>Frequency ref act 1</i>            | Displays the value of frequency reference source 1 (selected by parameter <a href="#">28.11 Frequency ref1 source</a> ). See the control chain diagram on page 576.<br>This parameter is read-only.   | -                              |
|       | -500.00 ... 500.00 Hz                 | Value of frequency reference source 1.  | See par. <a href="#">46.02</a> |
| 28.91 | <i>Frequency ref act 2</i>            | Displays the value of frequency reference source 2 (selected by parameter <a href="#">28.12 Frequency ref2 source</a> ). See the control chain diagram on page 576.<br>This parameter is read-only.   | -                              |
|       | -500.00 ... 500.00 Hz                 | Value of frequency reference source 2.  | See par. <a href="#">46.02</a> |
| 28.92 | <i>Frequency ref act 3</i>            | Displays the frequency reference after the function applied by parameter <a href="#">28.13 Frequency ref1 function</a> (if any), and after selection ( <a href="#">28.14 Frequency ref1/2 selection</a> ). See the control chain diagram on page 576.<br>This parameter is read-only. | -                              |
|       | -500.00 ... 500.00 Hz                 | Frequency reference after selection.  | See par. <a href="#">46.02</a> |
| 28.96 | <i>Frequency ref act 7</i>            | Displays the frequency reference after application of constant frequencies, control panel reference, etc. See the control chain diagram on page 576.<br>This parameter is read-only.  | -                              |
|       | -500.00 ... 500.00 Hz                 | Frequency reference 7.  | See par. <a href="#">46.02</a> |
| 28.97 | <i>Frequency ref unlimited</i>        | Displays the frequency reference after application of critical frequencies, but before ramping and limiting. See the control chain diagram on page 577.<br>This parameter is read-only.   | -                              |
|       | -500.00 ... 500.00 Hz                 | Frequency reference before ramping and limiting.  | See par. <a href="#">46.02</a> |

| No.              | Name/Value          | Description   | Def/FbEq16 |
|------------------|---------------------|---|------------|
| <b>30 Limits</b> |                     | Drive operation limits.   |            |
| 30.01            | <i>Limit word 1</i> | Displays limit word 1.<br>This parameter is read-only.  | -          |
| <b>Bit</b>       | <b>Name</b>         | <b>Description</b>  |            |
| 0                | Torq lim            | 1 = Drive torque is being limited by the motor control (undervoltage control, current control, load angle control or pull-out control), or by the torque limits defined by parameters.  |            |
| 1                | Spd ctl tlim min    | 1 = Speed controller output is being limited by <a href="#">25.11 Speed control min torque</a>  |            |
| 2                | Spd ctl tlim max    | 1 = Speed controller output is being limited by <a href="#">25.12 Speed control max torque</a>  |            |
| 3                | Torq ref max        | 1 = Torque reference ramp input is being limited by <a href="#">26.09 Maximum torque ref</a> , source of <a href="#">30.25 Maximum torque sel</a> , <a href="#">30.26 Power motoring limit</a> or <a href="#">30.27 Power generating limit</a> . See diagram on page 574. |            |
| 4                | Torq ref min        | 1 = Torque reference ramp input is being limited by <a href="#">26.08 Minimum torque ref</a> , source of <a href="#">30.18 Minimum torque sel</a> , <a href="#">30.26 Power motoring limit</a> or <a href="#">30.27 Power generating limit</a> . See diagram on page 574. |            |
| 5                | Tlim max speed      | 1 = Torque reference is being limited by the rush control because of maximum speed limit ( <a href="#">30.12 Maximum speed</a> )  |            |
| 6                | Tlim min speed      | 1 = Torque reference is being limited by the rush control because of minimum speed limit ( <a href="#">30.11 Minimum speed</a> )  |            |
| 7                | Max speed ref lim   | 1 = Speed reference is being limited by <a href="#">30.12 Maximum speed</a> or maximum permanent magnet motor speed limit based on DC voltage   |            |
| 8                | Min speed ref lim   | 1 = Speed reference is being limited by <a href="#">30.11 Minimum speed</a> or maximum permanent magnet motor speed limit based on DC voltage   |            |
| 9                | Max freq ref lim    | 1 = Frequency reference is being limited by <a href="#">30.14 Maximum frequency</a>   |            |
| 10               | Min freq ref lim    | 1 = Frequency reference is being limited by <a href="#">30.13 Minimum frequency</a>   |            |
| 11               | Reserved            |   |            |
| 12               | Sw freq ref lim     | 1 = Requested output frequency cannot be reached because of switching frequency limitation (because of eg. output filtering or ATEX-related protections)  |            |
| 13...15          | Reserved            |   |            |
| 0000h...FFFFh    | Limit word 1.       |   | 1 = 1      |



| No.   | Name/Value                    | Description  | Def/FbEq16   |     |      |             |   |              |   |   |             |  |   |                |  |   |                |  |   |                  |   |   |            |   |   |               |   |   |          |  |   |         |  |   |             |  |    |              |   |    |              |  |    |                      |  |    |               |   |         |          |  |
|---|-------------------------------|--|--|-----|------|-------------|---|--------------|---|---|-------------|--|---|----------------|--|---|----------------|--|---|------------------|---|---|------------|---|---|---------------|---|---|----------|--|---|---------|--|---|-------------|--|----|--------------|---|----|--------------|--|----|----------------------|--|----|---------------|---|---------|----------|--|
| 30.02   | <i>Torque limit status</i>    | Displays the torque controller limitation status word.<br>This parameter is read-only.   | -  |     |      |             |   |              |   |   |             |  |   |                |  |   |                |  |   |                  |   |   |            |   |   |               |   |   |          |  |   |         |  |   |             |  |    |              |   |    |              |  |    |                      |  |    |               |   |         |          |  |
| <table border="1"> <thead> <tr> <th>Bit</th> <th>Name</th> <th>Description</th> </tr> </thead> <tbody> <tr> <td>0</td> <td>Undervoltage</td> <td>*1 = Intermediate DC circuit undervoltage</td> </tr> <tr> <td>1</td> <td>Overvoltage</td> <td>*1 = Intermediate DC circuit overvoltage</td> </tr> <tr> <td>2</td> <td>Minimum torque</td> <td>*1 = Torque is being limited by <a href="#">30.26 Power motoring limit</a>, <a href="#">30.27 Power generating limit</a> or the source of <a href="#">30.18 Minimum torque sel.</a> See diagram on page <a href="#">574</a>.</td> </tr> <tr> <td>3</td> <td>Maximum torque</td> <td>*1 = Torque is being limited by <a href="#">30.26 Power motoring limit</a>, <a href="#">30.27 Power generating limit</a> or the source of <a href="#">30.25 Maximum torque sel.</a> See diagram on page <a href="#">574</a>.</td> </tr> <tr> <td>4</td> <td>Internal current</td> <td>1 = An inverter current limit (identified by bits 8...11) is active</td> </tr> <tr> <td>5</td> <td>Load angle</td> <td>(With permanent magnet motors and synchronous reluctance motors only)<br/>1 = Load angle limit is active, ie. the motor cannot produce any more torque</td> </tr> <tr> <td>6</td> <td>Motor pullout</td> <td>(With asynchronous motors only)<br/>1 = Motor pull-out limit is active, ie. the motor cannot produce any more torque</td> </tr> <tr> <td>7</td> <td>Reserved</td> <td></td> </tr> <tr> <td>8</td> <td>Thermal</td> <td>1 = Input current is being limited by the main circuit thermal limit</td> </tr> <tr> <td>9</td> <td>Max current</td> <td>*1 = Maximum output current (<math>I_{MAX}</math>) is being limited</td> </tr> <tr> <td>10</td> <td>User current</td> <td>*1 = Output current is being limited by <a href="#">30.17 Maximum current</a></td> </tr> <tr> <td>11</td> <td>Thermal IGBT</td> <td>*1 = Output current is being limited by a calculated thermal current value</td> </tr> <tr> <td>12</td> <td>IGBT overtemperature</td> <td>*1 = Output current is being limited because of estimated IGBT temperature</td> </tr> <tr> <td>13</td> <td>IGBT overload</td> <td>*1 = Output current is being limited because of IGBT junction to case temperature</td> </tr> <tr> <td>14...15</td> <td>Reserved</td> <td></td> </tr> </tbody> </table> <p>*Only one out of bits 0...3, and one out of bits 9...13 can be on simultaneously. The bit typically indicates the limit that is exceeded first.</p> |                               |  |  | Bit | Name | Description | 0 | Undervoltage | *1 = Intermediate DC circuit undervoltage | 1 | Overvoltage | *1 = Intermediate DC circuit overvoltage | 2 | Minimum torque | *1 = Torque is being limited by <a href="#">30.26 Power motoring limit</a> , <a href="#">30.27 Power generating limit</a> or the source of <a href="#">30.18 Minimum torque sel.</a> See diagram on page <a href="#">574</a> . | 3 | Maximum torque | *1 = Torque is being limited by <a href="#">30.26 Power motoring limit</a> , <a href="#">30.27 Power generating limit</a> or the source of <a href="#">30.25 Maximum torque sel.</a> See diagram on page <a href="#">574</a> . | 4 | Internal current | 1 = An inverter current limit (identified by bits 8...11) is active | 5 | Load angle | (With permanent magnet motors and synchronous reluctance motors only)<br>1 = Load angle limit is active, ie. the motor cannot produce any more torque | 6 | Motor pullout | (With asynchronous motors only)<br>1 = Motor pull-out limit is active, ie. the motor cannot produce any more torque | 7 | Reserved |  | 8 | Thermal | 1 = Input current is being limited by the main circuit thermal limit | 9 | Max current | *1 = Maximum output current ( $I_{MAX}$ ) is being limited | 10 | User current | *1 = Output current is being limited by <a href="#">30.17 Maximum current</a> | 11 | Thermal IGBT | *1 = Output current is being limited by a calculated thermal current value | 12 | IGBT overtemperature | *1 = Output current is being limited because of estimated IGBT temperature | 13 | IGBT overload | *1 = Output current is being limited because of IGBT junction to case temperature | 14...15 | Reserved |  |
| Bit   | Name                          | Description  |  |     |      |             |   |              |   |   |             |  |   |                |  |   |                |  |   |                  |   |   |            |   |   |               |   |   |          |  |   |         |  |   |             |  |    |              |   |    |              |  |    |                      |  |    |               |   |         |          |  |
| 0   | Undervoltage                  | *1 = Intermediate DC circuit undervoltage  |  |     |      |             |   |              |   |   |             |  |   |                |  |   |                |  |   |                  |   |   |            |   |   |               |   |   |          |  |   |         |  |   |             |  |    |              |   |    |              |  |    |                      |  |    |               |   |         |          |  |
| 1   | Overvoltage                   | *1 = Intermediate DC circuit overvoltage   |  |     |      |             |   |              |   |   |             |  |   |                |  |   |                |  |   |                  |   |   |            |   |   |               |   |   |          |  |   |         |  |   |             |  |    |              |   |    |              |  |    |                      |  |    |               |   |         |          |  |
| 2   | Minimum torque                | *1 = Torque is being limited by <a href="#">30.26 Power motoring limit</a> , <a href="#">30.27 Power generating limit</a> or the source of <a href="#">30.18 Minimum torque sel.</a> See diagram on page <a href="#">574</a> .   |  |     |      |             |   |              |   |   |             |  |   |                |  |   |                |  |   |                  |   |   |            |   |   |               |   |   |          |  |   |         |  |   |             |  |    |              |   |    |              |  |    |                      |  |    |               |   |         |          |  |
| 3   | Maximum torque                | *1 = Torque is being limited by <a href="#">30.26 Power motoring limit</a> , <a href="#">30.27 Power generating limit</a> or the source of <a href="#">30.25 Maximum torque sel.</a> See diagram on page <a href="#">574</a> .   |  |     |      |             |   |              |   |   |             |  |   |                |  |   |                |  |   |                  |   |   |            |   |   |               |   |   |          |  |   |         |  |   |             |  |    |              |   |    |              |  |    |                      |  |    |               |   |         |          |  |
| 4   | Internal current              | 1 = An inverter current limit (identified by bits 8...11) is active  |  |     |      |             |   |              |   |   |             |  |   |                |  |   |                |  |   |                  |   |   |            |   |   |               |   |   |          |  |   |         |  |   |             |  |    |              |   |    |              |  |    |                      |  |    |               |   |         |          |  |
| 5   | Load angle                    | (With permanent magnet motors and synchronous reluctance motors only)<br>1 = Load angle limit is active, ie. the motor cannot produce any more torque  |  |     |      |             |   |              |   |   |             |  |   |                |  |   |                |  |   |                  |   |   |            |   |   |               |   |   |          |  |   |         |  |   |             |  |    |              |   |    |              |  |    |                      |  |    |               |   |         |          |  |
| 6   | Motor pullout                 | (With asynchronous motors only)<br>1 = Motor pull-out limit is active, ie. the motor cannot produce any more torque  |  |     |      |             |   |              |   |   |             |  |   |                |  |   |                |  |   |                  |   |   |            |   |   |               |   |   |          |  |   |         |  |   |             |  |    |              |   |    |              |  |    |                      |  |    |               |   |         |          |  |
| 7   | Reserved                      |  |  |     |      |             |   |              |   |   |             |  |   |                |  |   |                |  |   |                  |   |   |            |   |   |               |   |   |          |  |   |         |  |   |             |  |    |              |   |    |              |  |    |                      |  |    |               |   |         |          |  |
| 8   | Thermal                       | 1 = Input current is being limited by the main circuit thermal limit   |  |     |      |             |   |              |   |   |             |  |   |                |  |   |                |  |   |                  |   |   |            |   |   |               |   |   |          |  |   |         |  |   |             |  |    |              |   |    |              |  |    |                      |  |    |               |   |         |          |  |
| 9   | Max current                   | *1 = Maximum output current ( $I_{MAX}$ ) is being limited   |  |     |      |             |   |              |   |   |             |  |   |                |  |   |                |  |   |                  |   |   |            |   |   |               |   |   |          |  |   |         |  |   |             |  |    |              |   |    |              |  |    |                      |  |    |               |   |         |          |  |
| 10  | User current                  | *1 = Output current is being limited by <a href="#">30.17 Maximum current</a>  |  |     |      |             |   |              |   |   |             |  |   |                |  |   |                |  |   |                  |   |   |            |   |   |               |   |   |          |  |   |         |  |   |             |  |    |              |   |    |              |  |    |                      |  |    |               |   |         |          |  |
| 11  | Thermal IGBT                  | *1 = Output current is being limited by a calculated thermal current value   |  |     |      |             |   |              |   |   |             |  |   |                |  |   |                |  |   |                  |   |   |            |   |   |               |   |   |          |  |   |         |  |   |             |  |    |              |   |    |              |  |    |                      |  |    |               |   |         |          |  |
| 12  | IGBT overtemperature          | *1 = Output current is being limited because of estimated IGBT temperature   |  |     |      |             |   |              |   |   |             |  |   |                |  |   |                |  |   |                  |   |   |            |   |   |               |   |   |          |  |   |         |  |   |             |  |    |              |   |    |              |  |    |                      |  |    |               |   |         |          |  |
| 13  | IGBT overload                 | *1 = Output current is being limited because of IGBT junction to case temperature  |  |     |      |             |   |              |   |   |             |  |   |                |  |   |                |  |   |                  |   |   |            |   |   |               |   |   |          |  |   |         |  |   |             |  |    |              |   |    |              |  |    |                      |  |    |               |   |         |          |  |
| 14...15   | Reserved                      |  |  |     |      |             |   |              |   |   |             |  |   |                |  |   |                |  |   |                  |   |   |            |   |   |               |   |   |          |  |   |         |  |   |             |  |    |              |   |    |              |  |    |                      |  |    |               |   |         |          |  |
|   | 0000h...FFFFh                 | Torque limitation status word.   | 1 = 1  |     |      |             |   |              |   |   |             |  |   |                |  |   |                |  |   |                  |   |   |            |   |   |               |   |   |          |  |   |         |  |   |             |  |    |              |   |    |              |  |    |                      |  |    |               |   |         |          |  |
| 30.11   | <i>Minimum speed</i>          | <p>Defines the minimum allowed speed.</p> <p> <b>WARNING!</b> This value must not be higher than <a href="#">30.12 Maximum speed</a>.</p> <p> <b>WARNING!</b> In frequency control mode, this limit is not effective. Make sure the frequency limits (<a href="#">30.13</a> and <a href="#">30.14</a>) are set appropriately if frequency control is used.</p> <p> <b>WARNING!</b> In a master/follower configuration, do not set maximum and minimum speed limits with the same sign on a follower drive. See section <a href="#">Master/follower functionality</a> (page <a href="#">31</a>).</p> | -1500.00 rpm;<br>-1800.00 rpm<br>( <a href="#">95.20</a> b0) |     |      |             |   |              |   |   |             |  |   |                |  |   |                |  |   |                  |   |   |            |   |   |               |   |   |          |  |   |         |  |   |             |  |    |              |   |    |              |  |    |                      |  |    |               |   |         |          |  |
|   | -30000.00 ...<br>30000.00 rpm | Minimum allowed speed.   | See par. <a href="#">46.01</a>                               |     |      |             |   |              |   |   |             |  |   |                |  |   |                |  |   |                  |   |   |            |   |   |               |   |   |          |  |   |         |  |   |             |  |    |              |   |    |              |  |    |                      |  |    |               |   |         |          |  |

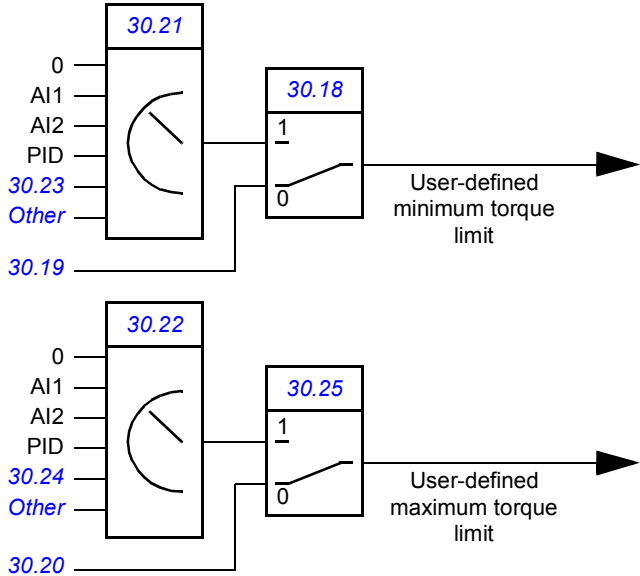

| No.   | Name/Value                          | Description   | Def/FbEq16                                |
|-------|-------------------------------------|---|---|
| 30.12 | <i>Maximum speed</i>                | <p>Defines the maximum allowed speed.</p> <p> <b>WARNING!</b> This value must not be lower than <a href="#">30.11 Minimum speed</a>.</p> <p> <b>WARNING!</b> In frequency control mode, this limit is not effective. Make sure the frequency limits (<a href="#">30.13</a> and <a href="#">30.14</a>) are set appropriately if frequency control is used.</p> <p> <b>WARNING!</b> In a master/follower configuration, do not set maximum and minimum speed limits with the same sign on a follower drive. See section <a href="#">Master/follower functionality</a> (page 31).</p> | 1500.00 rpm;<br>1800.00 rpm<br>(95.20 b0) |
|       | -30000.00 ...<br>30000.00 rpm       | Maximum speed.  | See par.<br><a href="#">46.01</a>         |
| 30.13 | <i>Minimum frequency</i>            | <p>Defines the minimum allowed frequency.</p> <p> <b>WARNING!</b> This value must not be higher than <a href="#">30.14 Maximum frequency</a>.</p> <p> <b>WARNING!</b> This limit is effective in frequency control mode only.</p>   | -50.00 Hz;<br>-60.00 Hz<br>(95.20 b0)     |
|       | -500.00 ... 500.00<br>Hz            | Minimum frequency.  | See par.<br><a href="#">46.02</a>         |
| 30.14 | <i>Maximum frequency</i>            | <p>Defines the maximum allowed frequency.</p> <p> <b>WARNING!</b> This value must not be lower than <a href="#">30.13 Minimum frequency</a>.</p> <p> <b>WARNING!</b> This limit is effective in frequency control mode only.</p>   | 50.00 Hz;<br>60.00 Hz<br>(95.20 b0)       |
|       | -500.00 ... 500.00<br>Hz            | Maximum frequency.  | See par.<br><a href="#">46.02</a>         |
| 30.15 | <i>Maximum start current enable</i> | <p>A temporary motor current limit specifically for starting can be defined by this parameter and <a href="#">30.16 Maximum start current</a>. When this parameter is set to <i>Enable</i>, the drive observes the start current limit defined by <a href="#">30.16 Maximum start current</a>. The limit is in force for 2 seconds after initial magnetization (of an asynchronous induction motor) or autophasing (of a permanent magnet motor), but not more often than once in every 7 seconds. Otherwise, the limit defined by <a href="#">30.17 Maximum current</a> is in force.</p> <p><b>Note:</b> The availability of a start current higher than the general limit depends on drive hardware.</p>  | <i>Disable</i>                            |
|       | Disable                             | Start current limit disabled.   | 0   |
|       | Enable                              | Start current limit enabled.  | 1   |
| 30.16 | <i>Maximum start current</i>        | Defines a maximum start current when enabled by parameter <a href="#">30.15 Maximum start current enable</a> .  | -   |
|       | 0.00 ... 30000.00 A                 | Maximum start current.  | 1 = 1 A                                   |
| 30.17 | <i>Maximum current</i>              | Defines the maximum allowed motor current.  | 0.00 A                                    |
|       | 0.00 ... 30000.00 A                 | Maximum motor current.  | 1 = 1 A                                   |

| No.   | Name/Value                | Description  | Def/FbEq16              |
|-------|---------------------------|--|-------------------------|
| 30.18 | <i>Minimum torque sel</i> | <p>Selects a source that switches between two different predefined minimum torque limits.</p> <p>0 = Minimum torque limit defined by 30.19 is active<br/>                     1 = Minimum torque limit selected by 30.21 is active</p> <p>The user can define two sets of torque limits, and switch between the sets using a binary source such as a digital input. The minimum limit selection (30.18) is independent of the maximum limit selection (30.25).</p> <p>The first set of limits is defined by parameters 30.19 and 30.20. The second set has selector parameters for both the minimum (30.21) and maximum (30.22) limits that allows the use of a selectable analog source (such as an analog input).</p>  <p>The limit selection parameters are updated on a 10 ms time level.</p> <p><b>Note:</b> In addition to the user-defined limits, torque may be limited for other reasons (such as power limitation). Refer to the block diagram on page 574.</p> | <i>Minimum torque 1</i> |
|       | Minimum torque 1          | 0 (minimum torque limit defined by 30.19 is active).   | 0                       |
|       | Minimum torque 2 source   | 1 (minimum torque limit selected by 30.21 is active).  | 1                       |
|       | DI1                       | Digital input DI1 ( <i>10.02 DI delayed status</i> , bit 0).   | 2                       |
|       | DI2                       | Digital input DI2 ( <i>10.02 DI delayed status</i> , bit 1).   | 3                       |
|       | DI3                       | Digital input DI3 ( <i>10.02 DI delayed status</i> , bit 2).   | 4                       |
|       | DI4                       | Digital input DI4 ( <i>10.02 DI delayed status</i> , bit 3).   | 5                       |
|       | DI5                       | Digital input DI5 ( <i>10.02 DI delayed status</i> , bit 4).   | 6                       |
|       | DI6                       | Digital input DI6 ( <i>10.02 DI delayed status</i> , bit 5).   | 7                       |
|       | DIO1                      | Digital input/output DIO1 ( <i>11.02 DIO delayed status</i> , bit 0).  | 10                      |
|       | DIO2                      | Digital input/output DIO2 ( <i>11.02 DIO delayed status</i> , bit 1).  | 11                      |
|       | <i>Other [bit]</i>        | Source selection (see <i>Terms and abbreviations</i> on page 112).   | -                       |

| No.   | Name/Value                     | Description   | Def/FbEq16                       |
|-------|--------------------------------|---|----------------------------------|
| 30.19 | <i>Minimum torque 1</i>        | Defines a minimum torque limit for the drive (in percent of nominal motor torque). See diagram at parameter <a href="#">30.18 Minimum torque sel.</a><br>The limit is effective when <ul style="list-style-type: none"> <li>the source selected by <a href="#">30.18 Minimum torque sel</a> is 0, or</li> <li><a href="#">30.18</a> is set to <i>Minimum torque 1</i>.</li> </ul> <b>Note:</b> Do not set this parameter to 0% in an attempt to prevent reverse rotation. In an open-loop application, that is likely to prevent the motor from stopping altogether. To prevent reverse rotation, use the speed/frequency limits in this parameter group, or parameters <a href="#">20.23/20.24</a> . | -300.0%                          |
|       | -1600.0 ... 0.0%               | Minimum torque limit 1.   | See par. <a href="#">46.03</a>   |
| 30.20 | <i>Maximum torque 1</i>        | Defines a maximum torque limit for the drive (in percent of nominal motor torque). See diagram at parameter <a href="#">30.18 Minimum torque sel.</a><br>The limit is effective when <ul style="list-style-type: none"> <li>the source selected by <a href="#">30.25 Maximum torque sel</a> is 0, or</li> <li><a href="#">30.25</a> is set to <i>Maximum torque 1</i>.</li> </ul>   | 300.0%                           |
|       | 0.0 ... 1600.0%                | Maximum torque 1.   | See par. <a href="#">46.03</a>   |
| 30.21 | <i>Minimum torque 2 source</i> | Defines the source of the minimum torque limit for the drive (in percent of nominal motor torque) when <ul style="list-style-type: none"> <li>the source selected by parameter <a href="#">30.18 Minimum torque sel</a> is 1, or</li> <li><a href="#">30.18</a> is set to <i>Minimum torque 2 source</i>.</li> </ul> See diagram at <a href="#">30.18 Minimum torque sel</a> .<br><b>Note:</b> Any positive values received from the selected source are inverted.  | <a href="#">Minimum torque 2</a> |
|       | Zero                           | None.   | 0                                |
|       | AI1 scaled                     | <a href="#">12.12 AI1 scaled value</a> (see page <a href="#">158</a> ).   | 1                                |
|       | AI2 scaled                     | <a href="#">12.22 AI2 scaled value</a> (see page <a href="#">160</a> ).   | 2                                |
|       | PID                            | <a href="#">40.01 Process PID output actual</a> (output of the process PID controller).   | 5                                |
|       | Minimum torque 2               | <a href="#">30.23 Minimum torque 2</a> .  | 6                                |
|       | <i>Other</i>                   | Source selection (see <a href="#">Terms and abbreviations</a> on page <a href="#">112</a> ).  | -                                |
| 30.22 | <i>Maximum torque 2 source</i> | Defines the source of the maximum torque limit for the drive (in percent of nominal motor torque) when <ul style="list-style-type: none"> <li>the source selected by parameter <a href="#">30.25 Maximum torque sel</a> is 1, or</li> <li><a href="#">30.25</a> is set to <i>Maximum torque 2 source</i>.</li> </ul> See diagram at <a href="#">30.18 Minimum torque sel</a> .<br><b>Note:</b> Any negative values received from the selected source are inverted.  | <a href="#">Maximum torque 2</a> |
|       | Zero                           | None.   | 0                                |
|       | AI1 scaled                     | <a href="#">12.12 AI1 scaled value</a> (see page <a href="#">158</a> ).   | 1                                |
|       | AI2 scaled                     | <a href="#">12.22 AI2 scaled value</a> (see page <a href="#">160</a> ).   | 2                                |
|       | PID                            | <a href="#">40.01 Process PID output actual</a> (output of the process PID controller).   | 5                                |
|       | Maximum torque 2               | <a href="#">30.24 Maximum torque 2</a> .  | 6                                |
|       | <i>Other</i>                   | Source selection (see <a href="#">Terms and abbreviations</a> on page <a href="#">112</a> ).  | -                                |

| No.   | Name/Value                    | Description   | Def/FbEq16              |
|-------|-------------------------------|---|-------------------------|
| 30.23 | <i>Minimum torque 2</i>       | Defines the minimum torque limit for the drive (in percent of nominal motor torque) when <ul style="list-style-type: none"> <li>the source selected by parameter <i>30.18 Minimum torque sel</i> is 1, and</li> <li><i>30.21</i> is set to <i>Minimum torque 2</i>.</li> </ul> <b>Note:</b> Do not set this parameter to 0% in an attempt to prevent reverse rotation. In an open-loop application, that is likely to prevent the motor from stopping altogether. To prevent reverse rotation, use the speed/frequency limits in this parameter group, or parameters <i>20.23/20.24</i> .<br>See diagram at <i>30.18 Minimum torque sel</i> . | -300.0%                 |
|       | -1600.0 ... 0.0%              | Minimum torque limit 2.   | See par. <i>46.03</i>   |
| 30.24 | <i>Maximum torque 2</i>       | Defines the maximum torque limit for the drive (in percent of nominal motor torque) when <ul style="list-style-type: none"> <li>the source selected by parameter <i>30.25 Maximum torque sel</i> is 1, and</li> <li><i>30.22</i> is set to <i>Maximum torque 2</i>.</li> </ul> See diagram at <i>30.18 Minimum torque sel</i> .   | 300.0%                  |
|       | 0.0 ... 1600.0%               | Maximum torque limit 2.   | See par. <i>46.03</i>   |
| 30.25 | <i>Maximum torque sel</i>     | Selects a source that switches between two different maximum torque limits.<br>0 = Maximum torque limit 1 defined by <i>30.20</i> is active<br>1 = Maximum torque limit selected by <i>30.22</i> is active<br>See also parameter <i>30.18 Minimum torque sel</i> .  | <i>Maximum torque 1</i> |
|       | Maximum torque 1              | 0.  | 0                       |
|       | Maximum torque 2 source       | 1.  | 1                       |
|       | DI1                           | Digital input DI1 ( <i>10.02 DI delayed status</i> , bit 0).  | 2                       |
|       | DI2                           | Digital input DI2 ( <i>10.02 DI delayed status</i> , bit 1).  | 3                       |
|       | DI3                           | Digital input DI3 ( <i>10.02 DI delayed status</i> , bit 2).  | 4                       |
|       | DI4                           | Digital input DI4 ( <i>10.02 DI delayed status</i> , bit 3).  | 5                       |
|       | DI5                           | Digital input DI5 ( <i>10.02 DI delayed status</i> , bit 4).  | 6                       |
|       | DI6                           | Digital input DI6 ( <i>10.02 DI delayed status</i> , bit 5).  | 7                       |
|       | DIO1                          | Digital input/output DIO1 ( <i>11.02 DIO delayed status</i> , bit 0).   | 10                      |
|       | DIO2                          | Digital input/output DIO2 ( <i>11.02 DIO delayed status</i> , bit 1).   | 11                      |
|       | <i>Other [bit]</i>            | Source selection (see <i>Terms and abbreviations</i> on page 112).  | -                       |
| 30.26 | <i>Power motoring limit</i>   | Defines the maximum shaft power in motoring mode, ie. when power is being transferred from the motor to the machinery. The value is given in percent of nominal motor power.  | 300.00%                 |
|       | 0.00 ... 600.00%              | Maximum shaft power in motoring mode.   | 1 = 1%                  |
| 30.27 | <i>Power generating limit</i> | Defines the maximum shaft power in generating mode, ie. when power is being transferred from the machinery to the motor. The value is given in percent of nominal motor power.<br><b>Note:</b> Do not set this parameter to 0% in an attempt to prevent reverse rotation. In an open-loop application, that is likely to prevent the motor from stopping altogether. To prevent reverse rotation, use the speed/frequency limits in this parameter group, or parameters <i>20.23/20.24</i> .  | -300.00%                |
|       | -600.00 ... 0.00%             | Maximum shaft power in generating mode.   | 1 = 1%                  |

| No.   | Name/Value                  | Description   | Def/FbEq16    |     |      |             |   |                |   |   |                |   |            |  |   |            |  |   |                    |   |   |                       |   |        |          |  |
|---|-----------------------------|---|---------------|-----|------|-------------|---|----------------|---|---|----------------|---|------------|--|---|------------|--|---|--------------------|---|---|-----------------------|---|--------|----------|--|
| 30.30   | <i>Overvoltage control</i>  | Enables the overvoltage control of the intermediate DC link. Fast braking of a high inertia load causes the voltage to rise to the overvoltage control limit. To prevent the DC voltage from exceeding the limit, the overvoltage controller automatically decreases the braking torque.<br><b>Note:</b> If the drive is equipped with a brake chopper and resistor, or a regenerative supply unit, the controller must be disabled.  | <i>Enable</i> |     |      |             |   |                |   |   |                |   |            |  |   |            |  |   |                    |   |   |                       |   |        |          |  |
|   | Disable                     | Overvoltage control disabled.   | 0             |     |      |             |   |                |   |   |                |   |            |  |   |            |  |   |                    |   |   |                       |   |        |          |  |
|   | Enable                      | Overvoltage control enabled.  | 1             |     |      |             |   |                |   |   |                |   |            |  |   |            |  |   |                    |   |   |                       |   |        |          |  |
| 30.31   | <i>Undervoltage control</i> | Enables the undervoltage control of the intermediate DC link. If the DC voltage drops due to input power cut off, the undervoltage controller will automatically decrease the motor torque in order to keep the voltage above the lower limit. By decreasing the motor torque, the inertia of the load will cause regeneration back to the drive, keeping the DC link charged and preventing an undervoltage trip until the motor coasts to a stop. This will act as a power-loss ride-through functionality in systems with high inertia, such as a centrifuge or a fan. | <i>Enable</i> |     |      |             |   |                |   |   |                |   |            |  |   |            |  |   |                    |   |   |                       |   |        |          |  |
|   | Disable                     | Undervoltage control disabled.  | 0             |     |      |             |   |                |   |   |                |   |            |  |   |            |  |   |                    |   |   |                       |   |        |          |  |
|   | Enable                      | Undervoltage control enabled.   | 1             |     |      |             |   |                |   |   |                |   |            |  |   |            |  |   |                    |   |   |                       |   |        |          |  |
| 30.101  | <i>LSU limit word 1</i>     | (Only visible when IGBT supply unit control activated by <a href="#">95.20</a> )<br>Displays limit word 1 of the supply unit.<br>This parameter is read-only.   | -             |     |      |             |   |                |   |   |                |   |            |  |   |            |  |   |                    |   |   |                       |   |        |          |  |
| <table border="1"> <thead> <tr> <th>Bit</th> <th>Name</th> <th>Description</th> </tr> </thead> <tbody> <tr> <td>0</td> <td>P user ref max</td> <td rowspan="2">1 = Power reference is being limited by supply control program parameters</td> </tr> <tr> <td>1</td> <td>P user ref min</td> </tr> <tr> <td>2</td> <td>P user max</td> <td>1 = Power is being limited by parameter <a href="#">30.149</a></td> </tr> <tr> <td>3</td> <td>P user min</td> <td>1 = Power is being limited by parameter <a href="#">30.148</a></td> </tr> <tr> <td>4</td> <td>P cooling overtemp</td> <td>1 = Power reference is being limited because of coolant overtemperature</td> </tr> <tr> <td>5</td> <td>P power unit overtemp</td> <td>1 = Power reference is being limited because of supply unit overtemperature</td> </tr> <tr> <td>6...15</td> <td>Reserved</td> <td></td> </tr> </tbody> </table> |                             |   |               | Bit | Name | Description | 0 | P user ref max | 1 = Power reference is being limited by supply control program parameters | 1 | P user ref min | 2 | P user max | 1 = Power is being limited by parameter <a href="#">30.149</a> | 3 | P user min | 1 = Power is being limited by parameter <a href="#">30.148</a> | 4 | P cooling overtemp | 1 = Power reference is being limited because of coolant overtemperature | 5 | P power unit overtemp | 1 = Power reference is being limited because of supply unit overtemperature | 6...15 | Reserved |  |
| Bit   | Name                        | Description   |               |     |      |             |   |                |   |   |                |   |            |  |   |            |  |   |                    |   |   |                       |   |        |          |  |
| 0   | P user ref max              | 1 = Power reference is being limited by supply control program parameters   |               |     |      |             |   |                |   |   |                |   |            |  |   |            |  |   |                    |   |   |                       |   |        |          |  |
| 1   | P user ref min              |   |               |     |      |             |   |                |   |   |                |   |            |  |   |            |  |   |                    |   |   |                       |   |        |          |  |
| 2   | P user max                  | 1 = Power is being limited by parameter <a href="#">30.149</a>  |               |     |      |             |   |                |   |   |                |   |            |  |   |            |  |   |                    |   |   |                       |   |        |          |  |
| 3   | P user min                  | 1 = Power is being limited by parameter <a href="#">30.148</a>  |               |     |      |             |   |                |   |   |                |   |            |  |   |            |  |   |                    |   |   |                       |   |        |          |  |
| 4   | P cooling overtemp          | 1 = Power reference is being limited because of coolant overtemperature   |               |     |      |             |   |                |   |   |                |   |            |  |   |            |  |   |                    |   |   |                       |   |        |          |  |
| 5   | P power unit overtemp       | 1 = Power reference is being limited because of supply unit overtemperature   |               |     |      |             |   |                |   |   |                |   |            |  |   |            |  |   |                    |   |   |                       |   |        |          |  |
| 6...15  | Reserved                    |   |               |     |      |             |   |                |   |   |                |   |            |  |   |            |  |   |                    |   |   |                       |   |        |          |  |
| 0000h...FFFFh   |                             | Supply unit limit word 1.   | 1 = 1         |     |      |             |   |                |   |   |                |   |            |  |   |            |  |   |                    |   |   |                       |   |        |          |  |

| No.  | Name/Value             | Description  | Def/FbEq16 |     |      |             |   |                    |   |   |                   |  |                    |  |   |                       |  |   |                      |   |       |                        |   |   |               |  |   |             |   |          |                    |   |   |              |   |         |          |  |    |           |   |    |           |   |    |           |   |    |           |   |
|--|------------------------|--|------------|-----|------|-------------|---|--------------------|---|---|-------------------|--|--------------------|--|---|-----------------------|--|---|----------------------|---|-------|------------------------|---|---|---------------|--|---|-------------|---|----------|--------------------|---|---|--------------|---|---------|----------|--|----|-----------|---|----|-----------|---|----|-----------|---|----|-----------|---|
| 30.102   | LSU limit word 2       | (Only visible when IGBT supply unit control activated by 95.20)<br>Displays limit word 2 of the supply unit.<br>This parameter is read-only. | -          |     |      |             |   |                    |   |   |                   |  |                    |  |   |                       |  |   |                      |   |       |                        |   |   |               |  |   |             |   |          |                    |   |   |              |   |         |          |  |    |           |   |    |           |   |    |           |   |    |           |   |
| <table border="1"> <thead> <tr> <th>Bit</th> <th>Name</th> <th>Description</th> </tr> </thead> <tbody> <tr> <td>0</td> <td>Q user ref max</td> <td rowspan="2">1 = Reactive power reference is being limited</td> </tr> <tr> <td>1</td> <td>Q user ref min</td> </tr> <tr> <td>2</td> <td>Q cooling overtemp</td> <td>1 = Reactive power reference is being limited because of coolant overtemperature</td> </tr> <tr> <td>3</td> <td>Q power unit overtemp</td> <td>1 = Reactive power reference is being limited because of supply unit overtemperature</td> </tr> <tr> <td>4</td> <td>AC overvoltage</td> <td>1 = AC overvoltage protection</td> </tr> <tr> <td>5...6</td> <td colspan="2">Reserved</td> </tr> <tr> <td>7</td> <td>AC diff max</td> <td rowspan="2">1 = (When AC voltage-type reactive power reference is being used) Input of AC control is being limited</td> </tr> <tr> <td>8</td> <td>AC diff min</td> </tr> <tr> <td>9...15</td> <td colspan="2">Reserved</td> </tr> </tbody> </table>   |                        |  |            | Bit | Name | Description | 0 | Q user ref max     | 1 = Reactive power reference is being limited             | 1 | Q user ref min    | 2  | Q cooling overtemp | 1 = Reactive power reference is being limited because of coolant overtemperature | 3   | Q power unit overtemp | 1 = Reactive power reference is being limited because of supply unit overtemperature | 4 | AC overvoltage       | 1 = AC overvoltage protection   | 5...6 | Reserved               |   | 7 | AC diff max   | 1 = (When AC voltage-type reactive power reference is being used) Input of AC control is being limited | 8 | AC diff min | 9...15  | Reserved |                    |   |   |              |   |         |          |  |    |           |   |    |           |   |    |           |   |    |           |   |
| Bit  | Name                   | Description  |            |     |      |             |   |                    |   |   |                   |  |                    |  |   |                       |  |   |                      |   |       |                        |   |   |               |  |   |             |   |          |                    |   |   |              |   |         |          |  |    |           |   |    |           |   |    |           |   |    |           |   |
| 0  | Q user ref max         | 1 = Reactive power reference is being limited  |            |     |      |             |   |                    |   |   |                   |  |                    |  |   |                       |  |   |                      |   |       |                        |   |   |               |  |   |             |   |          |                    |   |   |              |   |         |          |  |    |           |   |    |           |   |    |           |   |    |           |   |
| 1  | Q user ref min         |  |            |     |      |             |   |                    |   |   |                   |  |                    |  |   |                       |  |   |                      |   |       |                        |   |   |               |  |   |             |   |          |                    |   |   |              |   |         |          |  |    |           |   |    |           |   |    |           |   |    |           |   |
| 2  | Q cooling overtemp     | 1 = Reactive power reference is being limited because of coolant overtemperature   |            |     |      |             |   |                    |   |   |                   |  |                    |  |   |                       |  |   |                      |   |       |                        |   |   |               |  |   |             |   |          |                    |   |   |              |   |         |          |  |    |           |   |    |           |   |    |           |   |    |           |   |
| 3  | Q power unit overtemp  | 1 = Reactive power reference is being limited because of supply unit overtemperature   |            |     |      |             |   |                    |   |   |                   |  |                    |  |   |                       |  |   |                      |   |       |                        |   |   |               |  |   |             |   |          |                    |   |   |              |   |         |          |  |    |           |   |    |           |   |    |           |   |    |           |   |
| 4  | AC overvoltage         | 1 = AC overvoltage protection  |            |     |      |             |   |                    |   |   |                   |  |                    |  |   |                       |  |   |                      |   |       |                        |   |   |               |  |   |             |   |          |                    |   |   |              |   |         |          |  |    |           |   |    |           |   |    |           |   |    |           |   |
| 5...6  | Reserved               |  |            |     |      |             |   |                    |   |   |                   |  |                    |  |   |                       |  |   |                      |   |       |                        |   |   |               |  |   |             |   |          |                    |   |   |              |   |         |          |  |    |           |   |    |           |   |    |           |   |    |           |   |
| 7  | AC diff max            | 1 = (When AC voltage-type reactive power reference is being used) Input of AC control is being limited                                       |            |     |      |             |   |                    |   |   |                   |  |                    |  |   |                       |  |   |                      |   |       |                        |   |   |               |  |   |             |   |          |                    |   |   |              |   |         |          |  |    |           |   |    |           |   |    |           |   |    |           |   |
| 8  | AC diff min            |  |            |     |      |             |   |                    |   |   |                   |  |                    |  |   |                       |  |   |                      |   |       |                        |   |   |               |  |   |             |   |          |                    |   |   |              |   |         |          |  |    |           |   |    |           |   |    |           |   |    |           |   |
| 9...15   | Reserved               |  |            |     |      |             |   |                    |   |   |                   |  |                    |  |   |                       |  |   |                      |   |       |                        |   |   |               |  |   |             |   |          |                    |   |   |              |   |         |          |  |    |           |   |    |           |   |    |           |   |    |           |   |
|  | 0000h...FFFFh          | Supply unit limit word 2.  | 1 = 1      |     |      |             |   |                    |   |   |                   |  |                    |  |   |                       |  |   |                      |   |       |                        |   |   |               |  |   |             |   |          |                    |   |   |              |   |         |          |  |    |           |   |    |           |   |    |           |   |    |           |   |
| 30.103   | LSU limit word 3       | (Only visible when IGBT supply unit control activated by 95.20)<br>Displays limit word 3 of the supply unit.<br>This parameter is read-only. | -          |     |      |             |   |                    |   |   |                   |  |                    |  |   |                       |  |   |                      |   |       |                        |   |   |               |  |   |             |   |          |                    |   |   |              |   |         |          |  |    |           |   |    |           |   |    |           |   |    |           |   |
| <table border="1"> <thead> <tr> <th>Bit</th> <th>Name</th> <th>Description</th> </tr> </thead> <tbody> <tr> <td>0</td> <td>Undervoltage limit</td> <td>1 = Power is being limited by the undervoltage controller</td> </tr> <tr> <td>1</td> <td>Overvoltage limit</td> <td>1 = Power is being limited by the overvoltage controller</td> </tr> <tr> <td>2</td> <td>Motoring power</td> <td rowspan="2">1 = Power is being limited by temperature or user power limits (see parameters 30.148 and 30.149)</td> </tr> <tr> <td>3</td> <td>Generating power</td> </tr> <tr> <td>4</td> <td>Active current limit</td> <td>1 = Active current is being limited. For details, see bits 6...9 and 14...15.</td> </tr> <tr> <td>5</td> <td>Reactive current limit</td> <td>1 = Reactive current is being limited. For details, see bits 12...13.</td> </tr> <tr> <td>6</td> <td>Thermal limit</td> <td>1 = Active current is being limited by internal main circuit thermal limit</td> </tr> <tr> <td>7</td> <td>SOA limit</td> <td>1 = Active current is being limited by internal safe operation area limit</td> </tr> <tr> <td>8</td> <td>User current limit</td> <td>1 = Active current is being limited by current limit set by supply control program parameters</td> </tr> <tr> <td>9</td> <td>Thermal IGBT</td> <td>1 = Active current is being limited based on internal maximum thermal IGBT stress limit</td> </tr> <tr> <td>10...11</td> <td colspan="2">Reserved</td> </tr> <tr> <td>12</td> <td>Q act neg</td> <td>1 = Negative reactive current is being limited by maximum total current</td> </tr> <tr> <td>13</td> <td>Q act pos</td> <td>1 = Positive reactive current is being limited by maximum total current</td> </tr> <tr> <td>14</td> <td>P act neg</td> <td>1 = Negative active current is being limited by maximum total current</td> </tr> <tr> <td>15</td> <td>P act pos</td> <td>1 = Positive reactive current is being limited by maximum total current</td> </tr> </tbody> </table> |                        |  |            | Bit | Name | Description | 0 | Undervoltage limit | 1 = Power is being limited by the undervoltage controller | 1 | Overvoltage limit | 1 = Power is being limited by the overvoltage controller | 2                  | Motoring power   | 1 = Power is being limited by temperature or user power limits (see parameters 30.148 and 30.149) | 3                     | Generating power   | 4 | Active current limit | 1 = Active current is being limited. For details, see bits 6...9 and 14...15. | 5     | Reactive current limit | 1 = Reactive current is being limited. For details, see bits 12...13. | 6 | Thermal limit | 1 = Active current is being limited by internal main circuit thermal limit                             | 7 | SOA limit   | 1 = Active current is being limited by internal safe operation area limit | 8        | User current limit | 1 = Active current is being limited by current limit set by supply control program parameters | 9 | Thermal IGBT | 1 = Active current is being limited based on internal maximum thermal IGBT stress limit | 10...11 | Reserved |  | 12 | Q act neg | 1 = Negative reactive current is being limited by maximum total current | 13 | Q act pos | 1 = Positive reactive current is being limited by maximum total current | 14 | P act neg | 1 = Negative active current is being limited by maximum total current | 15 | P act pos | 1 = Positive reactive current is being limited by maximum total current |
| Bit  | Name                   | Description  |            |     |      |             |   |                    |   |   |                   |  |                    |  |   |                       |  |   |                      |   |       |                        |   |   |               |  |   |             |   |          |                    |   |   |              |   |         |          |  |    |           |   |    |           |   |    |           |   |    |           |   |
| 0  | Undervoltage limit     | 1 = Power is being limited by the undervoltage controller  |            |     |      |             |   |                    |   |   |                   |  |                    |  |   |                       |  |   |                      |   |       |                        |   |   |               |  |   |             |   |          |                    |   |   |              |   |         |          |  |    |           |   |    |           |   |    |           |   |    |           |   |
| 1  | Overvoltage limit      | 1 = Power is being limited by the overvoltage controller   |            |     |      |             |   |                    |   |   |                   |  |                    |  |   |                       |  |   |                      |   |       |                        |   |   |               |  |   |             |   |          |                    |   |   |              |   |         |          |  |    |           |   |    |           |   |    |           |   |    |           |   |
| 2  | Motoring power         | 1 = Power is being limited by temperature or user power limits (see parameters 30.148 and 30.149)  |            |     |      |             |   |                    |   |   |                   |  |                    |  |   |                       |  |   |                      |   |       |                        |   |   |               |  |   |             |   |          |                    |   |   |              |   |         |          |  |    |           |   |    |           |   |    |           |   |    |           |   |
| 3  | Generating power       |  |            |     |      |             |   |                    |   |   |                   |  |                    |  |   |                       |  |   |                      |   |       |                        |   |   |               |  |   |             |   |          |                    |   |   |              |   |         |          |  |    |           |   |    |           |   |    |           |   |    |           |   |
| 4  | Active current limit   | 1 = Active current is being limited. For details, see bits 6...9 and 14...15.  |            |     |      |             |   |                    |   |   |                   |  |                    |  |   |                       |  |   |                      |   |       |                        |   |   |               |  |   |             |   |          |                    |   |   |              |   |         |          |  |    |           |   |    |           |   |    |           |   |    |           |   |
| 5  | Reactive current limit | 1 = Reactive current is being limited. For details, see bits 12...13.  |            |     |      |             |   |                    |   |   |                   |  |                    |  |   |                       |  |   |                      |   |       |                        |   |   |               |  |   |             |   |          |                    |   |   |              |   |         |          |  |    |           |   |    |           |   |    |           |   |    |           |   |
| 6  | Thermal limit          | 1 = Active current is being limited by internal main circuit thermal limit   |            |     |      |             |   |                    |   |   |                   |  |                    |  |   |                       |  |   |                      |   |       |                        |   |   |               |  |   |             |   |          |                    |   |   |              |   |         |          |  |    |           |   |    |           |   |    |           |   |    |           |   |
| 7  | SOA limit              | 1 = Active current is being limited by internal safe operation area limit  |            |     |      |             |   |                    |   |   |                   |  |                    |  |   |                       |  |   |                      |   |       |                        |   |   |               |  |   |             |   |          |                    |   |   |              |   |         |          |  |    |           |   |    |           |   |    |           |   |    |           |   |
| 8  | User current limit     | 1 = Active current is being limited by current limit set by supply control program parameters  |            |     |      |             |   |                    |   |   |                   |  |                    |  |   |                       |  |   |                      |   |       |                        |   |   |               |  |   |             |   |          |                    |   |   |              |   |         |          |  |    |           |   |    |           |   |    |           |   |    |           |   |
| 9  | Thermal IGBT           | 1 = Active current is being limited based on internal maximum thermal IGBT stress limit  |            |     |      |             |   |                    |   |   |                   |  |                    |  |   |                       |  |   |                      |   |       |                        |   |   |               |  |   |             |   |          |                    |   |   |              |   |         |          |  |    |           |   |    |           |   |    |           |   |    |           |   |
| 10...11  | Reserved               |  |            |     |      |             |   |                    |   |   |                   |  |                    |  |   |                       |  |   |                      |   |       |                        |   |   |               |  |   |             |   |          |                    |   |   |              |   |         |          |  |    |           |   |    |           |   |    |           |   |    |           |   |
| 12   | Q act neg              | 1 = Negative reactive current is being limited by maximum total current  |            |     |      |             |   |                    |   |   |                   |  |                    |  |   |                       |  |   |                      |   |       |                        |   |   |               |  |   |             |   |          |                    |   |   |              |   |         |          |  |    |           |   |    |           |   |    |           |   |    |           |   |
| 13   | Q act pos              | 1 = Positive reactive current is being limited by maximum total current  |            |     |      |             |   |                    |   |   |                   |  |                    |  |   |                       |  |   |                      |   |       |                        |   |   |               |  |   |             |   |          |                    |   |   |              |   |         |          |  |    |           |   |    |           |   |    |           |   |    |           |   |
| 14   | P act neg              | 1 = Negative active current is being limited by maximum total current  |            |     |      |             |   |                    |   |   |                   |  |                    |  |   |                       |  |   |                      |   |       |                        |   |   |               |  |   |             |   |          |                    |   |   |              |   |         |          |  |    |           |   |    |           |   |    |           |   |    |           |   |
| 15   | P act pos              | 1 = Positive reactive current is being limited by maximum total current  |            |     |      |             |   |                    |   |   |                   |  |                    |  |   |                       |  |   |                      |   |       |                        |   |   |               |  |   |             |   |          |                    |   |   |              |   |         |          |  |    |           |   |    |           |   |    |           |   |    |           |   |
|  | 0000h...FFFFh          | Supply unit limit word 3.  | 1 = 1      |     |      |             |   |                    |   |   |                   |  |                    |  |   |                       |  |   |                      |   |       |                        |   |   |               |  |   |             |   |          |                    |   |   |              |   |         |          |  |    |           |   |    |           |   |    |           |   |    |           |   |

| No.   | Name/Value                     | Description   | Def/FbEq16                             |     |      |             |   |             |  |   |             |   |            |   |   |            |   |        |          |  |
|---|--------------------------------|---|--|-----|------|-------------|---|-------------|--|---|-------------|---|------------|---|---|------------|---|--------|----------|--|
| 30.104  | <i>LSU limit word 4</i>        | (Only visible when IGBT supply unit control activated by <a href="#">95.20</a> )<br>Displays limit word 4 of the supply unit.<br>This parameter is read-only.   | -                                      |     |      |             |   |             |  |   |             |   |            |   |   |            |   |        |          |  |
| <table border="1"> <thead> <tr> <th>Bit</th> <th>Name</th> <th>Description</th> </tr> </thead> <tbody> <tr> <td>0</td> <td>Udc ref max</td> <td rowspan="2">1 = DC reference is being limited by supply control program parameters</td> </tr> <tr> <td>1</td> <td>Udc ref min</td> </tr> <tr> <td>2</td> <td>User I max</td> <td>1 = Current is being limited by supply control program parameters</td> </tr> <tr> <td>3</td> <td>Temp I max</td> <td>1 = Current is being limited based on temperature</td> </tr> <tr> <td>4...15</td> <td>Reserved</td> <td></td> </tr> </tbody> </table> |                                |   |  | Bit | Name | Description | 0 | Udc ref max | 1 = DC reference is being limited by supply control program parameters | 1 | Udc ref min | 2 | User I max | 1 = Current is being limited by supply control program parameters | 3 | Temp I max | 1 = Current is being limited based on temperature | 4...15 | Reserved |  |
| Bit   | Name                           | Description   |  |     |      |             |   |             |  |   |             |   |            |   |   |            |   |        |          |  |
| 0   | Udc ref max                    | 1 = DC reference is being limited by supply control program parameters  |  |     |      |             |   |             |  |   |             |   |            |   |   |            |   |        |          |  |
| 1   | Udc ref min                    |   |  |     |      |             |   |             |  |   |             |   |            |   |   |            |   |        |          |  |
| 2   | User I max                     | 1 = Current is being limited by supply control program parameters   |  |     |      |             |   |             |  |   |             |   |            |   |   |            |   |        |          |  |
| 3   | Temp I max                     | 1 = Current is being limited based on temperature   |  |     |      |             |   |             |  |   |             |   |            |   |   |            |   |        |          |  |
| 4...15  | Reserved                       |   |  |     |      |             |   |             |  |   |             |   |            |   |   |            |   |        |          |  |
|   | 0000h...FFFFh                  | Supply unit limit word 4.   | 1 = 1                                  |     |      |             |   |             |  |   |             |   |            |   |   |            |   |        |          |  |
| 30.148  | <i>LSU minimum power limit</i> | (Only visible when IGBT supply unit control activated by <a href="#">95.20</a> )<br>Defines a minimum power limit for the supply unit.<br>Negative values refer to regenerating, ie. feeding power into the supply network. | -130.0%                                |     |      |             |   |             |  |   |             |   |            |   |   |            |   |        |          |  |
|   | -200.0 ... 0.0%                | Minimum power limit for supply unit.  | 1 = 1%                                 |     |      |             |   |             |  |   |             |   |            |   |   |            |   |        |          |  |
| 30.149  | <i>LSU maximum power limit</i> | (Only visible when IGBT supply unit control activated by <a href="#">95.20</a> )<br>Defines a maximum power limit for the supply unit.  | 130.0%                                 |     |      |             |   |             |  |   |             |   |            |   |   |            |   |        |          |  |
|   | 0.0 ... 200.0%                 | Maximum power limit for supply unit.  | 1 = 1%                                 |     |      |             |   |             |  |   |             |   |            |   |   |            |   |        |          |  |
| <b>31 Fault functions</b>   |                                | Configuration of external events; selection of behavior of the drive upon fault situations.   |  |     |      |             |   |             |  |   |             |   |            |   |   |            |   |        |          |  |
| 31.01   | <i>External event 1 source</i> | Defines the source of external event 1.<br>See also parameter <a href="#">31.02 External event 1 type</a> .<br>0 = Trigger event<br>1 = Normal operation  | <i>Inactive (true); D16 (95.20 b8)</i> |     |      |             |   |             |  |   |             |   |            |   |   |            |   |        |          |  |
|   | Active (false)                 | 0.  | 0                                      |     |      |             |   |             |  |   |             |   |            |   |   |            |   |        |          |  |
|   | Inactive (true)                | 1.  | 1                                      |     |      |             |   |             |  |   |             |   |            |   |   |            |   |        |          |  |
|   | DIIL                           | DIIL input ( <a href="#">10.02 DI delayed status</a> , bit 15).   | 2                                      |     |      |             |   |             |  |   |             |   |            |   |   |            |   |        |          |  |
|   | DI1                            | Digital input DI1 ( <a href="#">10.02 DI delayed status</a> , bit 0).   | 3                                      |     |      |             |   |             |  |   |             |   |            |   |   |            |   |        |          |  |
|   | DI2                            | Digital input DI2 ( <a href="#">10.02 DI delayed status</a> , bit 1).   | 4                                      |     |      |             |   |             |  |   |             |   |            |   |   |            |   |        |          |  |
|   | DI3                            | Digital input DI3 ( <a href="#">10.02 DI delayed status</a> , bit 2).   | 5                                      |     |      |             |   |             |  |   |             |   |            |   |   |            |   |        |          |  |
|   | DI4                            | Digital input DI4 ( <a href="#">10.02 DI delayed status</a> , bit 3).   | 6                                      |     |      |             |   |             |  |   |             |   |            |   |   |            |   |        |          |  |
|   | DI5                            | Digital input DI5 ( <a href="#">10.02 DI delayed status</a> , bit 4).   | 7                                      |     |      |             |   |             |  |   |             |   |            |   |   |            |   |        |          |  |
|   | DI6                            | Digital input DI6 ( <a href="#">10.02 DI delayed status</a> , bit 5).   | 8                                      |     |      |             |   |             |  |   |             |   |            |   |   |            |   |        |          |  |
|   | DIO1                           | Digital input/output DIO1 ( <a href="#">11.02 DIO delayed status</a> , bit 0).  | 11                                     |     |      |             |   |             |  |   |             |   |            |   |   |            |   |        |          |  |
|   | DIO2                           | Digital input/output DIO2 ( <a href="#">11.02 DIO delayed status</a> , bit 1).  | 12                                     |     |      |             |   |             |  |   |             |   |            |   |   |            |   |        |          |  |
|   | <i>Other [bit]</i>             | Source selection (see <a href="#">Terms and abbreviations</a> on page 112).   | -                                      |     |      |             |   |             |  |   |             |   |            |   |   |            |   |        |          |  |
| 31.02   | <i>External event 1 type</i>   | Selects the type of external event 1.   | <i>Fault (95.20 b8)</i>                |     |      |             |   |             |  |   |             |   |            |   |   |            |   |        |          |  |
|   | Fault                          | The external event generates a fault.   | 0                                      |     |      |             |   |             |  |   |             |   |            |   |   |            |   |        |          |  |
|   | Warning                        | The external event generates a warning.   | 1                                      |     |      |             |   |             |  |   |             |   |            |   |   |            |   |        |          |  |

## 264 Parameters

| No.   | Name/Value                     | Description   | Def/FbEq16                              |
|-------|--------------------------------|---|---|
|       | Warning/Fault                  | If the drive is modulating, the external event generates a fault. Otherwise, the event generates a warning.   | 3                                       |
| 31.03 | <i>External event 2 source</i> | Defines the source of external event 2. See also parameter <a href="#">31.04 External event 2 type</a> .<br>For the selections, see parameter <a href="#">31.01 External event 1 source</a> .   | <i>Inactive (true); DIIL (95.20 b5)</i> |
| 31.04 | <i>External event 2 type</i>   | Selects the type of external event 2.   |   |
|       | Fault                          | The external event generates a fault.   | 0                                       |
|       | Warning                        | The external event generates a warning.   | 1                                       |
|       | Warning/Fault                  | If the drive is modulating, the external event generates a fault. Otherwise, the event generates a warning.   | 3                                       |
| 31.05 | <i>External event 3 source</i> | Defines the source of external event 3. See also parameter <a href="#">31.06 External event 3 type</a> .<br>For the selections, see parameter <a href="#">31.01 External event 1 source</a> .   | <i>Inactive (true)</i>                  |
| 31.06 | <i>External event 3 type</i>   | Selects the type of external event 3.   |   |
|       | Fault                          | The external event generates a fault.   | 0                                       |
|       | Warning                        | The external event generates a warning.   | 1                                       |
|       | Warning/Fault                  | If the drive is modulating, the external event generates a fault. Otherwise, the event generates a warning.   | 3                                       |
| 31.07 | <i>External event 4 source</i> | Defines the source of external event 4. See also parameter <a href="#">31.08 External event 4 type</a> .<br>For the selections, see parameter <a href="#">31.01 External event 1 source</a> .   | <i>Inactive (true)</i>                  |
| 31.08 | <i>External event 4 type</i>   | Selects the type of external event 4.   |   |
|       | Fault                          | The external event generates a fault.   | 0                                       |
|       | Warning                        | The external event generates a warning.   | 1                                       |
|       | Warning/Fault                  | If the drive is modulating, the external event generates a fault. Otherwise, the event generates a warning.   | 3                                       |
| 31.09 | <i>External event 5 source</i> | Defines the source of external event 5. See also parameter <a href="#">31.10 External event 5 type</a> .<br>For the selections, see parameter <a href="#">31.01 External event 1 source</a> .   | <i>Inactive (true)</i>                  |
| 31.10 | <i>External event 5 type</i>   | Selects the type of external event 5.   |   |
|       | Fault                          | The external event generates a fault.   | 0                                       |
|       | Warning                        | The external event generates a warning.   | 1                                       |
|       | Warning/Fault                  | If the drive is modulating, the external event generates a fault. Otherwise, the event generates a warning.   | 3                                       |
| 31.11 | <i>Fault reset selection</i>   | Selects the source of an external fault reset signal. This signal will be observed even if it is not the active source in the current control location (EXT1/EXT2/Local).<br>(A reset from the active source will be observed regardless of this parameter.)<br>0 → 1 = Reset | <i>DI3</i>                              |
|       | Not selected                   | 0.  | 0                                       |



| No.          | Name/Value  | Description   | Def/FbEq16 |       |   |             |   |             |   |              |   |                      |   |             |       |          |   |  |   |  |    |   |    |   |    |   |    |   |    |   |    |   |  |
|--------------|---|---|------------|-------|---|-------------|---|-------------|---|--------------|---|----------------------|---|-------------|-------|----------|---|--|---|--|----|---|----|---|----|---|----|---|----|---|----|---|--|
|              | Selected  | 1.  | 1          |       |   |             |   |             |   |              |   |                      |   |             |       |          |   |  |   |  |    |   |    |   |    |   |    |   |    |   |    |   |  |
|              | DI1   | Digital input DI1 ( <a href="#">10.02 DI delayed status</a> , bit 0).   | 2          |       |   |             |   |             |   |              |   |                      |   |             |       |          |   |  |   |  |    |   |    |   |    |   |    |   |    |   |    |   |  |
|              | DI2   | Digital input DI2 ( <a href="#">10.02 DI delayed status</a> , bit 1).   | 3          |       |   |             |   |             |   |              |   |                      |   |             |       |          |   |  |   |  |    |   |    |   |    |   |    |   |    |   |    |   |  |
|              | DI3   | Digital input DI3 ( <a href="#">10.02 DI delayed status</a> , bit 2).   | 4          |       |   |             |   |             |   |              |   |                      |   |             |       |          |   |  |   |  |    |   |    |   |    |   |    |   |    |   |    |   |  |
|              | DI4   | Digital input DI4 ( <a href="#">10.02 DI delayed status</a> , bit 3).   | 5          |       |   |             |   |             |   |              |   |                      |   |             |       |          |   |  |   |  |    |   |    |   |    |   |    |   |    |   |    |   |  |
|              | DI5   | Digital input DI5 ( <a href="#">10.02 DI delayed status</a> , bit 4).   | 6          |       |   |             |   |             |   |              |   |                      |   |             |       |          |   |  |   |  |    |   |    |   |    |   |    |   |    |   |    |   |  |
|              | DI6   | Digital input DI6 ( <a href="#">10.02 DI delayed status</a> , bit 5).   | 7          |       |   |             |   |             |   |              |   |                      |   |             |       |          |   |  |   |  |    |   |    |   |    |   |    |   |    |   |    |   |  |
|              | DIO1  | Digital input/output DIO1 ( <a href="#">11.02 DIO delayed status</a> , bit 0).  | 10         |       |   |             |   |             |   |              |   |                      |   |             |       |          |   |  |   |  |    |   |    |   |    |   |    |   |    |   |    |   |  |
|              | DIO2  | Digital input/output DIO2 ( <a href="#">11.02 DIO delayed status</a> , bit 1).  | 11         |       |   |             |   |             |   |              |   |                      |   |             |       |          |   |  |   |  |    |   |    |   |    |   |    |   |    |   |    |   |  |
|              | FBA A MCW bit 7   | Control word bit 7 received through fieldbus interface A.   | 30         |       |   |             |   |             |   |              |   |                      |   |             |       |          |   |  |   |  |    |   |    |   |    |   |    |   |    |   |    |   |  |
|              | EFB MCW bit 7   | Control word bit 7 received through the embedded fieldbus interface.  | 32         |       |   |             |   |             |   |              |   |                      |   |             |       |          |   |  |   |  |    |   |    |   |    |   |    |   |    |   |    |   |  |
|              | <i>Other [bit]</i>  | Source selection (see <a href="#">Terms and abbreviations</a> on page 112).   | -          |       |   |             |   |             |   |              |   |                      |   |             |       |          |   |  |   |  |    |   |    |   |    |   |    |   |    |   |    |   |  |
| <b>31.12</b> | <b><i>Autoreset selection</i></b>   | <p>Selects faults that are automatically reset. The parameter is a 16-bit word with each bit corresponding to a fault type. Whenever a bit is set to 1, the corresponding fault is automatically reset.</p> <p>The number and interval of reset attempts are defined by parameters <a href="#">31.14</a>...<a href="#">31.16</a>.</p> <p> <b>WARNING!</b> Before you activate the function, make sure that no dangerous situations can occur. The function resets the drive automatically and continues operation after a fault.</p> <p><b>Notes:</b></p> <ul style="list-style-type: none"> <li>The autoreset function is only available in external control; see section <a href="#">Local control vs. external control</a> (page 20).</li> <li>Faults related to the Safe torque off (STO) function cannot be automatically reset.</li> </ul> <p>The bits of this binary number correspond to the following faults:</p>   | 0000h      |       |   |             |   |             |   |              |   |                      |   |             |       |          |   |  |   |  |    |   |    |   |    |   |    |   |    |   |    |   |  |
|              |   | <table border="1"> <thead> <tr> <th>Bit</th> <th>Fault</th> </tr> </thead> <tbody> <tr> <td>0</td> <td>Overcurrent</td> </tr> <tr> <td>1</td> <td>Overvoltage</td> </tr> <tr> <td>2</td> <td>Undervoltage</td> </tr> <tr> <td>3</td> <td>AI supervision fault</td> </tr> <tr> <td>4</td> <td>Supply unit</td> </tr> <tr> <td>5...7</td> <td>Reserved</td> </tr> <tr> <td>8</td> <td>Application fault 1 (defined in the application program)</td> </tr> <tr> <td>9</td> <td>Application fault 2 (defined in the application program)</td> </tr> <tr> <td>10</td> <td>Selectable fault (see parameter <a href="#">31.13 User selectable fault</a>)</td> </tr> <tr> <td>11</td> <td>External fault 1 (from source selected by parameter <a href="#">31.01 External event 1 source</a>)</td> </tr> <tr> <td>12</td> <td>External fault 2 (from source selected by parameter <a href="#">31.03 External event 2 source</a>)</td> </tr> <tr> <td>13</td> <td>External fault 3 (from source selected by parameter <a href="#">31.05 External event 3 source</a>)</td> </tr> <tr> <td>14</td> <td>External fault 4 (from source selected by parameter <a href="#">31.07 External event 4 source</a>)</td> </tr> <tr> <td>15</td> <td>External fault 5 (from source selected by parameter <a href="#">31.09 External event 5 source</a>)</td> </tr> </tbody> </table> | Bit        | Fault | 0 | Overcurrent | 1 | Overvoltage | 2 | Undervoltage | 3 | AI supervision fault | 4 | Supply unit | 5...7 | Reserved | 8 | Application fault 1 (defined in the application program) | 9 | Application fault 2 (defined in the application program) | 10 | Selectable fault (see parameter <a href="#">31.13 User selectable fault</a> ) | 11 | External fault 1 (from source selected by parameter <a href="#">31.01 External event 1 source</a> ) | 12 | External fault 2 (from source selected by parameter <a href="#">31.03 External event 2 source</a> ) | 13 | External fault 3 (from source selected by parameter <a href="#">31.05 External event 3 source</a> ) | 14 | External fault 4 (from source selected by parameter <a href="#">31.07 External event 4 source</a> ) | 15 | External fault 5 (from source selected by parameter <a href="#">31.09 External event 5 source</a> ) |  |
| Bit          | Fault   |   |            |       |   |             |   |             |   |              |   |                      |   |             |       |          |   |  |   |  |    |   |    |   |    |   |    |   |    |   |    |   |  |
| 0            | Overcurrent   |   |            |       |   |             |   |             |   |              |   |                      |   |             |       |          |   |  |   |  |    |   |    |   |    |   |    |   |    |   |    |   |  |
| 1            | Overvoltage   |   |            |       |   |             |   |             |   |              |   |                      |   |             |       |          |   |  |   |  |    |   |    |   |    |   |    |   |    |   |    |   |  |
| 2            | Undervoltage  |   |            |       |   |             |   |             |   |              |   |                      |   |             |       |          |   |  |   |  |    |   |    |   |    |   |    |   |    |   |    |   |  |
| 3            | AI supervision fault  |   |            |       |   |             |   |             |   |              |   |                      |   |             |       |          |   |  |   |  |    |   |    |   |    |   |    |   |    |   |    |   |  |
| 4            | Supply unit   |   |            |       |   |             |   |             |   |              |   |                      |   |             |       |          |   |  |   |  |    |   |    |   |    |   |    |   |    |   |    |   |  |
| 5...7        | Reserved  |   |            |       |   |             |   |             |   |              |   |                      |   |             |       |          |   |  |   |  |    |   |    |   |    |   |    |   |    |   |    |   |  |
| 8            | Application fault 1 (defined in the application program)  |   |            |       |   |             |   |             |   |              |   |                      |   |             |       |          |   |  |   |  |    |   |    |   |    |   |    |   |    |   |    |   |  |
| 9            | Application fault 2 (defined in the application program)  |   |            |       |   |             |   |             |   |              |   |                      |   |             |       |          |   |  |   |  |    |   |    |   |    |   |    |   |    |   |    |   |  |
| 10           | Selectable fault (see parameter <a href="#">31.13 User selectable fault</a> )                       |   |            |       |   |             |   |             |   |              |   |                      |   |             |       |          |   |  |   |  |    |   |    |   |    |   |    |   |    |   |    |   |  |
| 11           | External fault 1 (from source selected by parameter <a href="#">31.01 External event 1 source</a> ) |   |            |       |   |             |   |             |   |              |   |                      |   |             |       |          |   |  |   |  |    |   |    |   |    |   |    |   |    |   |    |   |  |
| 12           | External fault 2 (from source selected by parameter <a href="#">31.03 External event 2 source</a> ) |   |            |       |   |             |   |             |   |              |   |                      |   |             |       |          |   |  |   |  |    |   |    |   |    |   |    |   |    |   |    |   |  |
| 13           | External fault 3 (from source selected by parameter <a href="#">31.05 External event 3 source</a> ) |   |            |       |   |             |   |             |   |              |   |                      |   |             |       |          |   |  |   |  |    |   |    |   |    |   |    |   |    |   |    |   |  |
| 14           | External fault 4 (from source selected by parameter <a href="#">31.07 External event 4 source</a> ) |   |            |       |   |             |   |             |   |              |   |                      |   |             |       |          |   |  |   |  |    |   |    |   |    |   |    |   |    |   |    |   |  |
| 15           | External fault 5 (from source selected by parameter <a href="#">31.09 External event 5 source</a> ) |   |            |       |   |             |   |             |   |              |   |                      |   |             |       |          |   |  |   |  |    |   |    |   |    |   |    |   |    |   |    |   |  |
|              | 0000h...FFFFh   | Automatic reset configuration word.   | 1 = 1      |       |   |             |   |             |   |              |   |                      |   |             |       |          |   |  |   |  |    |   |    |   |    |   |    |   |    |   |    |   |  |

| No.   | Name/Value                   | Description  | Def/FbEq16   |
|-------|------------------------------|--|--------------|
| 31.13 | <i>User selectable fault</i> | Defines the fault that can be automatically reset using parameter <a href="#">31.12 Autoreset selection</a> , bit 10. The faults are listed in chapter <a href="#">Fault tracing</a> (page 508).   | 0000h        |
|       | 0000h...FFFFh                | Fault code.  | 10 = 1       |
| 31.14 | <i>Number of trials</i>      | Defines the maximum number of automatic resets that the drive is allowed to attempt within the time specified by <a href="#">31.15 Total trials time</a> .<br>If the fault persists, subsequent reset attempts will be made at intervals defined by <a href="#">31.16 Delay time</a> .<br>The faults to be automatically reset are defined by <a href="#">31.12 Autoreset selection</a> .  | 0            |
|       | 0...5                        | Number of automatic resets.  | 1 = 1        |
| 31.15 | <i>Total trials time</i>     | Defines a time window for automatic fault resets. The maximum number of attempts made during any period of this length is defined by <a href="#">31.14 Number of trials</a> .<br><b>Note:</b> If the fault condition remains and cannot be reset, each reset attempt will generate an event and start a new time window. In practice, if the specified number of resets ( <a href="#">31.14</a> ) at specified intervals ( <a href="#">31.16</a> ) take longer than the value of <a href="#">31.15</a> , the drive will continue to attempt resetting the fault until the cause is eventually removed. | 30.0 s       |
|       | 1.0 ... 600.0 s              | Time for automatic resets.   | 10 = 1 s     |
| 31.16 | <i>Delay time</i>            | Defines the time that the drive will wait after a fault (or a previous reset attempt) before attempting an automatic reset. See parameter <a href="#">31.12 Autoreset selection</a> .  | 0.0 s        |
|       | 0.0 ... 120.0 s              | Autoreset delay.   | 10 = 1 s     |
| 31.19 | <i>Motor phase loss</i>      | Selects how the drive reacts when a motor phase loss is detected.  | <i>Fault</i> |
|       | No action                    | No action taken.   | 0            |
|       | Fault                        | The drive trips on fault <a href="#">3381 Output phase loss</a> .  | 1            |
| 31.20 | <i>Earth fault</i>           | Selects how the drive reacts when an earth fault or current unbalance is detected in the motor or the motor cable.   | <i>Fault</i> |
|       | No action                    | No action taken.   | 0            |
|       | Warning                      | The drive generates an <a href="#">A2B3 Earth leakage</a> warning.   | 1            |
|       | Fault                        | The drive trips on fault <a href="#">2330 Earth leakage</a> .  | 2            |
| 31.21 | <i>Supply phase loss</i>     | Selects how the drive reacts when a supply phase loss is detected.   | <i>Fault</i> |
|       | No action                    | No action taken.   | 0            |
|       | Fault                        | The drive trips on fault <a href="#">3130 Input phase loss</a> .   | 1            |

| No.    | Name/Value                     | Description  | Def/FbEq16   |  |                                 |     |     |     |         |                                   |   |   |   |                                     |   |   |   |  |                    |   |   |  |   |   |                    |  |   |
|--------|--------------------------------|--|--|--|---------------------------------|-----|-----|-----|---------|-----------------------------------|---|---|---|-------------------------------------|---|---|---|--|--------------------|---|---|--|---|---|--------------------|--|---|
| 31.22  | <i>STO indication run/stop</i> | <p>Selects which indications are given when one or both Safe torque off (STO) signals are switched off or lost. The indications also depend on whether the drive is running or stopped when this occurs.</p> <p>The tables at each selection below show the indications generated with that particular setting.</p> <p><b>Notes:</b></p> <ul style="list-style-type: none"> <li>This parameter does not affect the operation of the STO function itself. The STO function will operate regardless of the setting of this parameter: a running drive will stop upon removal of one or both STO signals, and will not start until both STO signals are restored and all faults reset.</li> <li>The loss of only one STO signal always generates a fault as it is interpreted as a malfunction.</li> </ul> <p>For more information on the STO, see the <i>Hardware manual</i> of the drive.</p>   | <i>Fault/Fault</i>   |  |                                 |     |     |     |         |                                   |   |   |   |                                     |   |   |   |  |                    |   |   |  |   |   |                    |  |   |
|        | Fault/Fault                    | <table border="1" data-bbox="550 813 1263 1099"> <thead> <tr> <th colspan="2" data-bbox="550 813 711 848">Inputs</th> <th data-bbox="711 813 1263 887" rowspan="2">Indication (running or stopped)</th> </tr> <tr> <th data-bbox="550 848 633 887">IN1</th> <th data-bbox="633 848 711 887">IN2</th> </tr> </thead> <tbody> <tr> <td data-bbox="550 887 633 922">0</td> <td data-bbox="633 887 711 922">0</td> <td data-bbox="711 887 1263 922">Fault <i>5091 Safe torque off</i></td> </tr> <tr> <td data-bbox="550 922 633 987">0</td> <td data-bbox="633 922 711 987">1</td> <td data-bbox="711 922 1263 987">Faults <i>5091 Safe torque off</i> and <i>FA81 Safe torque off 1 loss</i></td> </tr> <tr> <td data-bbox="550 987 633 1052">1</td> <td data-bbox="633 987 711 1052">0</td> <td data-bbox="711 987 1263 1052">Faults <i>5091 Safe torque off</i> and <i>FA82 Safe torque off 2 loss</i></td> </tr> <tr> <td data-bbox="550 1052 633 1099">1</td> <td data-bbox="633 1052 711 1099">1</td> <td data-bbox="711 1052 1263 1099">(Normal operation)</td> </tr> </tbody> </table>  | Inputs   |  | Indication (running or stopped) | IN1 | IN2 | 0   | 0       | Fault <i>5091 Safe torque off</i> | 0 | 1 | Faults <i>5091 Safe torque off</i> and <i>FA81 Safe torque off 1 loss</i> | 1                                   | 0 | Faults <i>5091 Safe torque off</i> and <i>FA82 Safe torque off 2 loss</i> | 1   | 1  | (Normal operation) | 0 |   |  |   |   |                    |  |   |
| Inputs |                                | Indication (running or stopped)  |  |  |                                 |     |     |     |         |                                   |   |   |   |                                     |   |   |   |  |                    |   |   |  |   |   |                    |  |   |
| IN1    | IN2                            |  |  |  |                                 |     |     |     |         |                                   |   |   |   |                                     |   |   |   |  |                    |   |   |  |   |   |                    |  |   |
| 0      | 0                              | Fault <i>5091 Safe torque off</i>  |  |  |                                 |     |     |     |         |                                   |   |   |   |                                     |   |   |   |  |                    |   |   |  |   |   |                    |  |   |
| 0      | 1                              | Faults <i>5091 Safe torque off</i> and <i>FA81 Safe torque off 1 loss</i>  |  |  |                                 |     |     |     |         |                                   |   |   |   |                                     |   |   |   |  |                    |   |   |  |   |   |                    |  |   |
| 1      | 0                              | Faults <i>5091 Safe torque off</i> and <i>FA82 Safe torque off 2 loss</i>  |  |  |                                 |     |     |     |         |                                   |   |   |   |                                     |   |   |   |  |                    |   |   |  |   |   |                    |  |   |
| 1      | 1                              | (Normal operation)   |  |  |                                 |     |     |     |         |                                   |   |   |   |                                     |   |   |   |  |                    |   |   |  |   |   |                    |  |   |
|        | Fault/Warning                  | <table border="1" data-bbox="550 1198 1263 1632"> <thead> <tr> <th colspan="2" data-bbox="550 1198 711 1234">Inputs</th> <th colspan="2" data-bbox="711 1198 1263 1234">Indication</th> </tr> <tr> <th data-bbox="550 1234 633 1270">IN1</th> <th data-bbox="633 1234 711 1270">IN2</th> <th data-bbox="711 1234 989 1270">Running</th> <th data-bbox="989 1234 1263 1270">Stopped</th> </tr> </thead> <tbody> <tr> <td data-bbox="550 1270 633 1335">0</td> <td data-bbox="633 1270 711 1335">0</td> <td data-bbox="711 1270 989 1335">Fault <i>5091 Safe torque off</i></td> <td data-bbox="989 1270 1263 1335">Warning <i>A5A0 Safe torque off</i></td> </tr> <tr> <td data-bbox="550 1335 633 1464">0</td> <td data-bbox="633 1335 711 1464">1</td> <td data-bbox="711 1335 989 1464">Faults <i>5091 Safe torque off</i> and <i>FA81 Safe torque off 1 loss</i></td> <td data-bbox="989 1335 1263 1464">Warning <i>A5A0 Safe torque off</i> and fault <i>FA81 Safe torque off 1 loss</i></td> </tr> <tr> <td data-bbox="550 1464 633 1594">1</td> <td data-bbox="633 1464 711 1594">0</td> <td data-bbox="711 1464 989 1594">Faults <i>5091 Safe torque off</i> and <i>FA82 Safe torque off 2 loss</i></td> <td data-bbox="989 1464 1263 1594">Warning <i>A5A0 Safe torque off</i> and fault <i>FA82 Safe torque off 2 loss</i></td> </tr> <tr> <td data-bbox="550 1594 633 1632">1</td> <td data-bbox="633 1594 711 1632">1</td> <td colspan="2" data-bbox="711 1594 1263 1632">(Normal operation)</td> </tr> </tbody> </table> | Inputs   |  | Indication                      |     | IN1 | IN2 | Running | Stopped                           | 0 | 0 | Fault <i>5091 Safe torque off</i>   | Warning <i>A5A0 Safe torque off</i> | 0 | 1   | Faults <i>5091 Safe torque off</i> and <i>FA81 Safe torque off 1 loss</i> | Warning <i>A5A0 Safe torque off</i> and fault <i>FA81 Safe torque off 1 loss</i> | 1                  | 0 | Faults <i>5091 Safe torque off</i> and <i>FA82 Safe torque off 2 loss</i> | Warning <i>A5A0 Safe torque off</i> and fault <i>FA82 Safe torque off 2 loss</i> | 1 | 1 | (Normal operation) |  | 1 |
| Inputs |                                | Indication   |  |  |                                 |     |     |     |         |                                   |   |   |   |                                     |   |   |   |  |                    |   |   |  |   |   |                    |  |   |
| IN1    | IN2                            | Running  | Stopped  |  |                                 |     |     |     |         |                                   |   |   |   |                                     |   |   |   |  |                    |   |   |  |   |   |                    |  |   |
| 0      | 0                              | Fault <i>5091 Safe torque off</i>  | Warning <i>A5A0 Safe torque off</i>  |  |                                 |     |     |     |         |                                   |   |   |   |                                     |   |   |   |  |                    |   |   |  |   |   |                    |  |   |
| 0      | 1                              | Faults <i>5091 Safe torque off</i> and <i>FA81 Safe torque off 1 loss</i>  | Warning <i>A5A0 Safe torque off</i> and fault <i>FA81 Safe torque off 1 loss</i> |  |                                 |     |     |     |         |                                   |   |   |   |                                     |   |   |   |  |                    |   |   |  |   |   |                    |  |   |
| 1      | 0                              | Faults <i>5091 Safe torque off</i> and <i>FA82 Safe torque off 2 loss</i>  | Warning <i>A5A0 Safe torque off</i> and fault <i>FA82 Safe torque off 2 loss</i> |  |                                 |     |     |     |         |                                   |   |   |   |                                     |   |   |   |  |                    |   |   |  |   |   |                    |  |   |
| 1      | 1                              | (Normal operation)   |  |  |                                 |     |     |     |         |                                   |   |   |   |                                     |   |   |   |  |                    |   |   |  |   |   |                    |  |   |

| No.    | Name/Value                   | Description   | Def/FbEq16   |  |                                 |     |     |     |         |                                     |   |   |  |                                   |   |  |   |  |                    |   |   |  |   |   |                    |  |   |
|--------|------------------------------|---|--|--|---------------------------------|-----|-----|-----|---------|-------------------------------------|---|---|--|-----------------------------------|---|--|---|--|--------------------|---|---|--|---|---|--------------------|--|---|
|        | Fault/Event                  | <table border="1"> <thead> <tr> <th colspan="2">Inputs</th> <th colspan="2">Indication</th> </tr> <tr> <th>IN1</th> <th>IN2</th> <th>Running</th> <th>Stopped</th> </tr> </thead> <tbody> <tr> <td>0</td> <td>0</td> <td>Fault <i>5091 Safe torque off</i></td> <td>Event <i>B5A0 Safe torque off</i></td> </tr> <tr> <td>0</td> <td>1</td> <td>Faults <i>5091 Safe torque off</i> and <i>FA81 Safe torque off 1 loss</i></td> <td>Event <i>B5A0 Safe torque off</i> and fault <i>FA81 Safe torque off 1 loss</i></td> </tr> <tr> <td>1</td> <td>0</td> <td>Faults <i>5091 Safe torque off</i> and <i>FA82 Safe torque off 2 loss</i></td> <td>Event <i>B5A0 Safe torque off</i> and fault <i>FA82 Safe torque off 2 loss</i></td> </tr> <tr> <td>1</td> <td>1</td> <td colspan="2">(Normal operation)</td> </tr> </tbody> </table> | Inputs   |  | Indication                      |     | IN1 | IN2 | Running | Stopped                             | 0 | 0 | Fault <i>5091 Safe torque off</i>  | Event <i>B5A0 Safe torque off</i> | 0 | 1  | Faults <i>5091 Safe torque off</i> and <i>FA81 Safe torque off 1 loss</i> | Event <i>B5A0 Safe torque off</i> and fault <i>FA81 Safe torque off 1 loss</i> | 1                  | 0 | Faults <i>5091 Safe torque off</i> and <i>FA82 Safe torque off 2 loss</i> | Event <i>B5A0 Safe torque off</i> and fault <i>FA82 Safe torque off 2 loss</i> | 1 | 1 | (Normal operation) |  | 2 |
| Inputs |                              | Indication  |  |  |                                 |     |     |     |         |                                     |   |   |  |                                   |   |  |   |  |                    |   |   |  |   |   |                    |  |   |
| IN1    | IN2                          | Running   | Stopped  |  |                                 |     |     |     |         |                                     |   |   |  |                                   |   |  |   |  |                    |   |   |  |   |   |                    |  |   |
| 0      | 0                            | Fault <i>5091 Safe torque off</i>   | Event <i>B5A0 Safe torque off</i>  |  |                                 |     |     |     |         |                                     |   |   |  |                                   |   |  |   |  |                    |   |   |  |   |   |                    |  |   |
| 0      | 1                            | Faults <i>5091 Safe torque off</i> and <i>FA81 Safe torque off 1 loss</i>   | Event <i>B5A0 Safe torque off</i> and fault <i>FA81 Safe torque off 1 loss</i> |  |                                 |     |     |     |         |                                     |   |   |  |                                   |   |  |   |  |                    |   |   |  |   |   |                    |  |   |
| 1      | 0                            | Faults <i>5091 Safe torque off</i> and <i>FA82 Safe torque off 2 loss</i>   | Event <i>B5A0 Safe torque off</i> and fault <i>FA82 Safe torque off 2 loss</i> |  |                                 |     |     |     |         |                                     |   |   |  |                                   |   |  |   |  |                    |   |   |  |   |   |                    |  |   |
| 1      | 1                            | (Normal operation)  |  |  |                                 |     |     |     |         |                                     |   |   |  |                                   |   |  |   |  |                    |   |   |  |   |   |                    |  |   |
|        | Warning/Warning              | <table border="1"> <thead> <tr> <th colspan="2">Inputs</th> <th rowspan="2">Indication (running or stopped)</th> </tr> <tr> <th>IN1</th> <th>IN2</th> </tr> </thead> <tbody> <tr> <td>0</td> <td>0</td> <td>Warning <i>A5A0 Safe torque off</i></td> </tr> <tr> <td>0</td> <td>1</td> <td>Warning <i>A5A0 Safe torque off</i> and fault <i>FA81 Safe torque off 1 loss</i></td> </tr> <tr> <td>1</td> <td>0</td> <td>Warning <i>A5A0 Safe torque off</i> and fault <i>FA82 Safe torque off 2 loss</i></td> </tr> <tr> <td>1</td> <td>1</td> <td>(Normal operation)</td> </tr> </tbody> </table>   | Inputs   |  | Indication (running or stopped) | IN1 | IN2 | 0   | 0       | Warning <i>A5A0 Safe torque off</i> | 0 | 1 | Warning <i>A5A0 Safe torque off</i> and fault <i>FA81 Safe torque off 1 loss</i> | 1                                 | 0 | Warning <i>A5A0 Safe torque off</i> and fault <i>FA82 Safe torque off 2 loss</i> | 1   | 1  | (Normal operation) | 3 |   |  |   |   |                    |  |   |
| Inputs |                              | Indication (running or stopped)   |  |  |                                 |     |     |     |         |                                     |   |   |  |                                   |   |  |   |  |                    |   |   |  |   |   |                    |  |   |
| IN1    | IN2                          |   |  |  |                                 |     |     |     |         |                                     |   |   |  |                                   |   |  |   |  |                    |   |   |  |   |   |                    |  |   |
| 0      | 0                            | Warning <i>A5A0 Safe torque off</i>   |  |  |                                 |     |     |     |         |                                     |   |   |  |                                   |   |  |   |  |                    |   |   |  |   |   |                    |  |   |
| 0      | 1                            | Warning <i>A5A0 Safe torque off</i> and fault <i>FA81 Safe torque off 1 loss</i>  |  |  |                                 |     |     |     |         |                                     |   |   |  |                                   |   |  |   |  |                    |   |   |  |   |   |                    |  |   |
| 1      | 0                            | Warning <i>A5A0 Safe torque off</i> and fault <i>FA82 Safe torque off 2 loss</i>  |  |  |                                 |     |     |     |         |                                     |   |   |  |                                   |   |  |   |  |                    |   |   |  |   |   |                    |  |   |
| 1      | 1                            | (Normal operation)  |  |  |                                 |     |     |     |         |                                     |   |   |  |                                   |   |  |   |  |                    |   |   |  |   |   |                    |  |   |
|        | Event/Event                  | <table border="1"> <thead> <tr> <th colspan="2">Inputs</th> <th rowspan="2">Indication (running or stopped)</th> </tr> <tr> <th>IN1</th> <th>IN2</th> </tr> </thead> <tbody> <tr> <td>0</td> <td>0</td> <td>Event <i>B5A0 STO event</i></td> </tr> <tr> <td>0</td> <td>1</td> <td>Event <i>B5A0 STO event</i> and fault <i>FA81 Safe torque off 1 loss</i></td> </tr> <tr> <td>1</td> <td>0</td> <td>Event <i>B5A0 STO event</i> and fault <i>FA82 Safe torque off 2 loss</i></td> </tr> <tr> <td>1</td> <td>1</td> <td>(Normal operation)</td> </tr> </tbody> </table>   | Inputs   |  | Indication (running or stopped) | IN1 | IN2 | 0   | 0       | Event <i>B5A0 STO event</i>         | 0 | 1 | Event <i>B5A0 STO event</i> and fault <i>FA81 Safe torque off 1 loss</i>         | 1                                 | 0 | Event <i>B5A0 STO event</i> and fault <i>FA82 Safe torque off 2 loss</i>         | 1   | 1  | (Normal operation) | 4 |   |  |   |   |                    |  |   |
| Inputs |                              | Indication (running or stopped)   |  |  |                                 |     |     |     |         |                                     |   |   |  |                                   |   |  |   |  |                    |   |   |  |   |   |                    |  |   |
| IN1    | IN2                          |   |  |  |                                 |     |     |     |         |                                     |   |   |  |                                   |   |  |   |  |                    |   |   |  |   |   |                    |  |   |
| 0      | 0                            | Event <i>B5A0 STO event</i>   |  |  |                                 |     |     |     |         |                                     |   |   |  |                                   |   |  |   |  |                    |   |   |  |   |   |                    |  |   |
| 0      | 1                            | Event <i>B5A0 STO event</i> and fault <i>FA81 Safe torque off 1 loss</i>  |  |  |                                 |     |     |     |         |                                     |   |   |  |                                   |   |  |   |  |                    |   |   |  |   |   |                    |  |   |
| 1      | 0                            | Event <i>B5A0 STO event</i> and fault <i>FA82 Safe torque off 2 loss</i>  |  |  |                                 |     |     |     |         |                                     |   |   |  |                                   |   |  |   |  |                    |   |   |  |   |   |                    |  |   |
| 1      | 1                            | (Normal operation)  |  |  |                                 |     |     |     |         |                                     |   |   |  |                                   |   |  |   |  |                    |   |   |  |   |   |                    |  |   |
|        | No indication/No indication  | <table border="1"> <thead> <tr> <th colspan="2">Inputs</th> <th rowspan="2">Indication (running or stopped)</th> </tr> <tr> <th>IN1</th> <th>IN2</th> </tr> </thead> <tbody> <tr> <td>0</td> <td>0</td> <td>None</td> </tr> <tr> <td>0</td> <td>1</td> <td>Fault <i>FA81 Safe torque off 1 loss</i></td> </tr> <tr> <td>1</td> <td>0</td> <td>Fault <i>FA82 Safe torque off 2 loss</i></td> </tr> <tr> <td>1</td> <td>1</td> <td>(Normal operation)</td> </tr> </tbody> </table>  | Inputs   |  | Indication (running or stopped) | IN1 | IN2 | 0   | 0       | None                                | 0 | 1 | Fault <i>FA81 Safe torque off 1 loss</i>   | 1                                 | 0 | Fault <i>FA82 Safe torque off 2 loss</i>   | 1   | 1  | (Normal operation) | 5 |   |  |   |   |                    |  |   |
| Inputs |                              | Indication (running or stopped)   |  |  |                                 |     |     |     |         |                                     |   |   |  |                                   |   |  |   |  |                    |   |   |  |   |   |                    |  |   |
| IN1    | IN2                          |   |  |  |                                 |     |     |     |         |                                     |   |   |  |                                   |   |  |   |  |                    |   |   |  |   |   |                    |  |   |
| 0      | 0                            | None  |  |  |                                 |     |     |     |         |                                     |   |   |  |                                   |   |  |   |  |                    |   |   |  |   |   |                    |  |   |
| 0      | 1                            | Fault <i>FA81 Safe torque off 1 loss</i>  |  |  |                                 |     |     |     |         |                                     |   |   |  |                                   |   |  |   |  |                    |   |   |  |   |   |                    |  |   |
| 1      | 0                            | Fault <i>FA82 Safe torque off 2 loss</i>  |  |  |                                 |     |     |     |         |                                     |   |   |  |                                   |   |  |   |  |                    |   |   |  |   |   |                    |  |   |
| 1      | 1                            | (Normal operation)  |  |  |                                 |     |     |     |         |                                     |   |   |  |                                   |   |  |   |  |                    |   |   |  |   |   |                    |  |   |
| 31.23  | <i>Wiring or earth fault</i> | <p>Selects how the drive reacts to incorrect input power and motor cable connection (i.e. input power cable is connected to drive motor connection).</p> <p><b>Note:</b> The protection must be disabled with drive/inverter hardware supplied from a common DC bus.</p>  | <i>Fault</i>   |  |                                 |     |     |     |         |                                     |   |   |  |                                   |   |  |   |  |                    |   |   |  |   |   |                    |  |   |
|        | No action                    | No action taken (protection disabled).  | 0  |  |                                 |     |     |     |         |                                     |   |   |  |                                   |   |  |   |  |                    |   |   |  |   |   |                    |  |   |
|        | Fault                        | The drive trips on fault <i>3181 Wiring or earth fault</i> .  | 1  |  |                                 |     |     |     |         |                                     |   |   |  |                                   |   |  |   |  |                    |   |   |  |   |   |                    |  |   |

| No.                   | Name/Value                            | Description   | Def/FbEq16   |
|-----------------------|---------------------------------------|---|--|
| <a href="#">31.24</a> | <a href="#">Stall function</a>        | Selects how the drive reacts to a motor stall condition. A stall condition is defined as follows: <ul style="list-style-type: none"> <li>• The drive exceeds the stall current limit (<a href="#">31.25 Stall current limit</a>), and</li> <li>• the output frequency is below the level set by parameter <a href="#">31.27 Stall frequency limit</a> or the motor speed is below the level set by parameter <a href="#">31.26 Stall speed limit</a>, and</li> <li>• the conditions above have been true longer than the time set by parameter <a href="#">31.28 Stall time</a>.</li> </ul> | <a href="#">Fault</a>                                    |
|                       | No action                             | None (stall supervision disabled).  | 0  |
|                       | Warning                               | The drive generates an <a href="#">A780 Motor stall</a> warning.  | 1  |
|                       | Fault                                 | The drive trips on fault <a href="#">7121 Motor stall</a> .   | 2  |
| <a href="#">31.25</a> | <a href="#">Stall current limit</a>   | Stall current limit in percent of the nominal current of the motor. See parameter <a href="#">31.24 Stall function</a> .  | 200.0%   |
|                       | 0.0 ... 1600.0%                       | Stall current limit.  | 10 = 1%  |
| <a href="#">31.26</a> | <a href="#">Stall speed limit</a>     | Stall speed limit in rpm. See parameter <a href="#">31.24 Stall function</a> .  | 150.00 rpm;<br>180.00 rpm<br>( <a href="#">95.20</a> b0) |
|                       | 0.00 ... 10000.00 rpm                 | Stall speed limit.  | See par. <a href="#">46.01</a>                           |
| <a href="#">31.27</a> | <a href="#">Stall frequency limit</a> | Stall frequency limit. See parameter <a href="#">31.24 Stall function</a> .<br><b>Note:</b> Setting the limit below 10 Hz is not recommended.   | 15.00 Hz;<br>18.00 Hz<br>( <a href="#">95.20</a> b0)     |
|                       | 0.00 ... 500.00 Hz                    | Stall frequency limit.  | See par. <a href="#">46.02</a>                           |
| <a href="#">31.28</a> | <a href="#">Stall time</a>            | Stall time. See parameter <a href="#">31.24 Stall function</a> .  | 20 s   |
|                       | 0 ... 3600 s                          | Stall time.   | 1 = 1 s  |

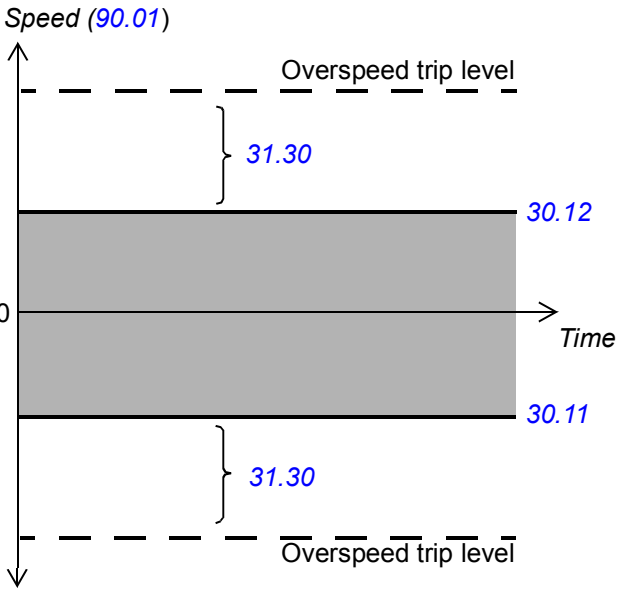
| No.   | Name/Value                        | Description  | Def/FbEq16                     |
|-------|-----------------------------------|--|--------------------------------|
| 31.30 | <i>Overspeed trip margin</i>      | <p>Defines, together with <a href="#">30.11 Minimum speed</a> and <a href="#">30.12 Maximum speed</a>, the maximum allowed speed of the motor (overspeed protection). If <a href="#">90.01 Motor speed for control</a> or the estimated speed exceeds the speed limit defined by parameter <a href="#">30.11</a> or <a href="#">30.12</a> by more than the value of this parameter, the drive trips on the <a href="#">7310 Overspeed</a> fault.</p> <p><b>Example:</b> If the maximum speed is 1420 rpm and speed trip margin is 300 rpm, the drive trips at 1720 rpm.</p>   | 500.00 rpm                     |
|       | 0.00 ... 10000.0 rpm              | Overspeed trip margin.   | See par. <a href="#">46.01</a> |
| 31.32 | <i>Emergency ramp supervision</i> | <p>Parameters <a href="#">31.32 Emergency ramp supervision</a> and <a href="#">31.33 Emergency ramp supervision delay</a>, together with <a href="#">01.29 Speed change rate</a>, provide a supervision function for emergency stop modes Off1 and Off3.</p> <p>The supervision is based on either</p> <ul style="list-style-type: none"> <li>• observing the time within which the motor stops, or</li> <li>• comparing the actual and expected deceleration rates.</li> </ul> <p>If this parameter is set to 0%, the maximum stop time is directly set in parameter <a href="#">31.33</a>. Otherwise, <a href="#">31.32</a> defines the maximum allowed deviation from the expected deceleration rate, which is calculated from parameters <a href="#">23.11...23.19</a> (Off1) or <a href="#">23.23 Emergency stop time</a> (Off3). If the actual deceleration rate (<a href="#">01.29</a>) deviates too much from the expected rate, the drive trips on <a href="#">73B0 Emergency ramp failed</a>, sets bit 8 of <a href="#">06.17 Drive status word 2</a>, and coasts to a stop.</p> <p>If <a href="#">31.32</a> is set to 0% and <a href="#">31.33</a> is set to 0 s, the emergency stop ramp supervision is disabled.</p> <p>See also parameter <a href="#">21.04 Emergency stop mode</a>.</p> | 0%                             |
|       | 0...300%                          | Maximum deviation from expected deceleration rate.   | 1 = 1%                         |

| No.   | Name/Value                              | Description  | Def/FbEq16     |
|-------|---|--|----------------|
| 31.33 | <i>Emergency ramp supervision delay</i> | <p>If parameter <a href="#">31.32 Emergency ramp supervision</a> is set to 0%, this parameter defines the maximum time an emergency stop (mode Off1 or Off3) is allowed to take. If the motor has not stopped when the time elapses, the drive trips on <a href="#">73B0 Emergency ramp failed</a>, sets bit 8 of <a href="#">06.17 Drive status word 2</a>, and coasts to a stop.</p> <p>If <a href="#">31.32</a> is set to a value other than 0%, this parameter defines a delay between the receipt of the emergency stop command and the activation of the supervision. It is recommended to specify a short delay to allow the speed change rate to stabilize.</p>  | 0 s            |
|       | 0...32767 s                             | Maximum ramp-down time, or supervision activation delay.   | 1 = 1 s        |
| 31.35 | <i>Main fan fault function</i>          | <p>Selects how the drive reacts when a main cooling fan fault is detected.</p> <p><b>Note:</b> With an inverter unit consisting of one or more frame R8i inverter modules with speed-controlled fans, it may be possible to continue operation even if one main fan of a module stops. When fan failure is detected, the control program will automatically</p> <ul style="list-style-type: none"> <li>• set the other fan of the module to full speed</li> <li>• set the fans of the other modules (if any) to full speed</li> <li>• decrease the switching frequency to a minimum, and</li> <li>• disable the supervision of temperature difference between the modules.</li> </ul> <p>If this parameter is set to <i>Fault</i>, the inverter unit will trip (but still carry out the actions listed above). Otherwise, the inverter will attempt to continue operation.</p>   | <i>Warning</i> |
|       | Fault                                   | The drive trips on fault <a href="#">5080 Fan</a> .  | 0              |
|       | Warning                                 | The drive generates an <a href="#">A581 Fan</a> warning.   | 1              |
|       | No action                               | No action taken.   | 2              |
| 31.36 | <i>Aux fan fault bypass</i>             | <p><i>(Only visible with a ZCU control unit)</i></p> <p>Temporarily suppresses auxiliary fan faults. Certain drive types (especially those protected to IP55) have an auxiliary fan built into the front cover as standard. If the fan is sticking or disconnected, the control program generates a fault (<a href="#">5081 Auxiliary fan broken</a>).</p> <p>If it is necessary to operate the drive without the front cover (for example, during commissioning), this parameter can be activated to temporarily generate a warning (<a href="#">A582 Auxiliary fan missing</a>) instead of the fault.</p> <p><b>Notes:</b></p> <ul style="list-style-type: none"> <li>• The parameter must be activated within 2 minutes of control unit reboot (either by cycling the power or by parameter <a href="#">96.08</a>).</li> <li>• The parameter will be in effect until the auxiliary fan is reconnected and detected, or until the next control unit reboot.</li> </ul> | <i>Off</i>     |
|       | Off                                     | Normal operation.  | 0              |
|       | Temporarily bypassed                    | <p>The auxiliary fan fault is temporarily replaced by a warning indication.</p> <p>The setting will revert automatically to <i>Off</i>.</p>  | 1              |

| No.    | Name/Value                         | Description   | Def/FbEq16                     |       |   |             |   |          |   |           |   |           |   |                           |        |          |  |
|--------|------------------------------------|---|--------------------------------|-------|---|-------------|---|----------|---|-----------|---|-----------|---|---------------------------|--------|----------|--|
| 31.37  | <i>Ramp stop supervision</i>       | <p>Parameters <a href="#">31.37 Ramp stop supervision</a> and <a href="#">31.38 Ramp stop supervision delay</a>, together with <a href="#">01.29 Speed change rate</a>, provide a supervision function for normal (ie. non-emergency) ramp stopping.</p> <p>The supervision is based on either</p> <ul style="list-style-type: none"> <li>observing the time within which the motor stops, or</li> <li>comparing the actual and expected deceleration rates.</li> </ul> <p>If this parameter is set to 0%, the maximum stop time is directly set in parameter <a href="#">31.38</a>. Otherwise, <a href="#">31.37</a> defines the maximum allowed deviation from the expected deceleration rate, which is calculated from parameters <a href="#">23.11...23.19</a>. If the actual deceleration rate (<a href="#">01.29</a>) deviates too much from the expected rate, the drive trips on <a href="#">73B1 Stop failed</a>, sets bit 14 of <a href="#">06.17 Drive status word 2</a>, and coasts to a stop.</p> <p>If <a href="#">31.37</a> is set to 0% and <a href="#">31.38</a> is set to 0 s, the ramp stop supervision is disabled.</p> | 0%                             |       |   |             |   |          |   |           |   |           |   |                           |        |          |  |
|        | 0...300%                           | Maximum deviation from expected deceleration rate.  | 1 = 1%                         |       |   |             |   |          |   |           |   |           |   |                           |        |          |  |
| 31.38  | <i>Ramp stop supervision delay</i> | <p>If parameter <a href="#">31.37 Ramp stop supervision</a> is set to 0%, this parameter defines the maximum time a ramp stop is allowed to take. If the motor has not stopped when the time elapses, the drive trips on <a href="#">73B1 Stop failed</a>, sets bit 14 of <a href="#">06.17 Drive status word 2</a>, and coasts to a stop.</p> <p>If <a href="#">31.37</a> is set to a value other than 0%, this parameter defines a delay between the receipt of the stop command and the activation of the supervision. It is recommended to specify a short delay to allow the speed change rate to stabilize.</p>   | 0 s                            |       |   |             |   |          |   |           |   |           |   |                           |        |          |  |
|        | 0...32767 s                        | Maximum ramp-down time, or supervision activation delay.  | 1 = 1 s                        |       |   |             |   |          |   |           |   |           |   |                           |        |          |  |
| 31.40  | <i>Disable warning messages</i>    | <p>Selects warnings to be suppressed. The parameter is a 16-bit word with each bit corresponding to a warning. Whenever a bit is set to 1, the corresponding warning is suppressed.</p> <p>The bits of this binary number correspond to the following warnings:</p>   | 0000b                          |       |   |             |   |          |   |           |   |           |   |                           |        |          |  |
|        |                                    | <table border="1"> <thead> <tr> <th>Bit</th> <th>Fault</th> </tr> </thead> <tbody> <tr> <td>0</td> <td>Overvoltage</td> </tr> <tr> <td>1</td> <td>Reserved</td> </tr> <tr> <td>2</td> <td>Encoder 1</td> </tr> <tr> <td>3</td> <td>Encoder 2</td> </tr> <tr> <td>4</td> <td>CU (Control unit) battery</td> </tr> <tr> <td>5...15</td> <td>Reserved</td> </tr> </tbody> </table>   | Bit                            | Fault | 0 | Overvoltage | 1 | Reserved | 2 | Encoder 1 | 3 | Encoder 2 | 4 | CU (Control unit) battery | 5...15 | Reserved |  |
| Bit    | Fault                              |   |                                |       |   |             |   |          |   |           |   |           |   |                           |        |          |  |
| 0      | Overvoltage                        |   |                                |       |   |             |   |          |   |           |   |           |   |                           |        |          |  |
| 1      | Reserved                           |   |                                |       |   |             |   |          |   |           |   |           |   |                           |        |          |  |
| 2      | Encoder 1                          |   |                                |       |   |             |   |          |   |           |   |           |   |                           |        |          |  |
| 3      | Encoder 2                          |   |                                |       |   |             |   |          |   |           |   |           |   |                           |        |          |  |
| 4      | CU (Control unit) battery          |   |                                |       |   |             |   |          |   |           |   |           |   |                           |        |          |  |
| 5...15 | Reserved                           |   |                                |       |   |             |   |          |   |           |   |           |   |                           |        |          |  |
|        | 0000b...1101b                      | Warning suppression word.   | 1 = 1                          |       |   |             |   |          |   |           |   |           |   |                           |        |          |  |
| 31.42  | <i>Overcurrent fault limit</i>     | <p>Sets a custom motor current fault limit.</p> <p>The drive automatically sets an internal motor current limit according to the drive hardware. The internal limit is appropriate in most cases, but this parameter can be used to set a lower current limit, for example, to protect a permanent magnet motor from demagnetization.</p> <p><b>Note:</b> The limit defines the maximum peak current of one phase.</p> <p>With this parameter at 0.0 A, only the internal limit is in force.</p>  | 0.00 A                         |       |   |             |   |          |   |           |   |           |   |                           |        |          |  |
|        | 0.00 ... 30000.00 A                | Custom motor current fault limit.   | See par. <a href="#">46.05</a> |       |   |             |   |          |   |           |   |           |   |                           |        |          |  |



| No.  | Name/Value                    | Description  | Def/FbEq16      |     |      |             |   |                      |   |   |                      |   |   |                      |   |        |          |  |
|--|-------------------------------|--|-----------------|-----|------|-------------|---|----------------------|---|---|----------------------|---|---|----------------------|---|--------|----------|--|
| 31.120   | <i>LSU earth fault</i>        | (Only visible when IGBT supply unit control activated by 95.20)<br>Selects how the supply unit reacts when an earth fault or current unbalance is detected.  | <i>Fault</i>    |     |      |             |   |                      |   |   |                      |   |   |                      |   |        |          |  |
|  | No action                     | No action taken.   | 0               |     |      |             |   |                      |   |   |                      |   |   |                      |   |        |          |  |
|  | Warning                       | The supply unit generates an AE02 Earth leakage warning.   | 1               |     |      |             |   |                      |   |   |                      |   |   |                      |   |        |          |  |
|  | Fault                         | The supply unit trips on fault 2E01 Earth leakage.   | 2               |     |      |             |   |                      |   |   |                      |   |   |                      |   |        |          |  |
| 31.121   | <i>LSU supply phase loss</i>  | (Only visible when IGBT supply unit control activated by 95.20)<br>Selects how the supply unit reacts when a supply phase loss is detected.  | <i>Fault</i>    |     |      |             |   |                      |   |   |                      |   |   |                      |   |        |          |  |
|  | No action                     | No action taken.   | 0               |     |      |             |   |                      |   |   |                      |   |   |                      |   |        |          |  |
|  | Fault                         | The supply unit trips on fault 3E00 Input phase loss.  | 1               |     |      |             |   |                      |   |   |                      |   |   |                      |   |        |          |  |
| <b>32 Supervision</b>  |                               | Configuration of signal supervision functions 1...3. Three values can be chosen to be monitored; a warning or fault is generated whenever predefined limits are exceeded. See also section <i>Signal supervision</i> (page 87).  |                 |     |      |             |   |                      |   |   |                      |   |   |                      |   |        |          |  |
| 32.01  | <i>Supervision status</i>     | Signal supervision status word.<br>Indicates whether the values monitored by the signal supervision functions are within or outside their respective limits.<br><b>Note:</b> This word is independent of the drive actions defined by parameters 32.06, 32.16 and 32.26. | 0000b           |     |      |             |   |                      |   |   |                      |   |   |                      |   |        |          |  |
| <table border="1"> <thead> <tr> <th>Bit</th> <th>Name</th> <th>Description</th> </tr> </thead> <tbody> <tr> <td>0</td> <td>Supervision 1 active</td> <td>1 = Signal selected by 32.07 is outside its limits.</td> </tr> <tr> <td>1</td> <td>Supervision 2 active</td> <td>1 = Signal selected by 32.17 is outside its limits.</td> </tr> <tr> <td>2</td> <td>Supervision 3 active</td> <td>1 = Signal selected by 32.27 is outside its limits.</td> </tr> <tr> <td>3...15</td> <td>Reserved</td> <td></td> </tr> </tbody> </table> |                               |  |                 | Bit | Name | Description | 0 | Supervision 1 active | 1 = Signal selected by 32.07 is outside its limits. | 1 | Supervision 2 active | 1 = Signal selected by 32.17 is outside its limits. | 2 | Supervision 3 active | 1 = Signal selected by 32.27 is outside its limits. | 3...15 | Reserved |  |
| Bit  | Name                          | Description  |                 |     |      |             |   |                      |   |   |                      |   |   |                      |   |        |          |  |
| 0  | Supervision 1 active          | 1 = Signal selected by 32.07 is outside its limits.  |                 |     |      |             |   |                      |   |   |                      |   |   |                      |   |        |          |  |
| 1  | Supervision 2 active          | 1 = Signal selected by 32.17 is outside its limits.  |                 |     |      |             |   |                      |   |   |                      |   |   |                      |   |        |          |  |
| 2  | Supervision 3 active          | 1 = Signal selected by 32.27 is outside its limits.  |                 |     |      |             |   |                      |   |   |                      |   |   |                      |   |        |          |  |
| 3...15   | Reserved                      |  |                 |     |      |             |   |                      |   |   |                      |   |   |                      |   |        |          |  |
|  | 0000...0111b                  | Signal supervision status word.  | 1 = 1           |     |      |             |   |                      |   |   |                      |   |   |                      |   |        |          |  |
| 32.05  | <i>Supervision 1 function</i> | Selects the mode of signal supervision function 1. Determines how the monitored signal (see parameter 32.07) is compared to its lower and upper limits (32.09 and 32.10 respectively). The action to be taken when the condition is fulfilled is selected by 32.06.      | <i>Disabled</i> |     |      |             |   |                      |   |   |                      |   |   |                      |   |        |          |  |
|  | Disabled                      | Signal supervision 1 not in use.   | 0               |     |      |             |   |                      |   |   |                      |   |   |                      |   |        |          |  |
|  | Low                           | Action is taken whenever the signal falls below its lower limit.   | 1               |     |      |             |   |                      |   |   |                      |   |   |                      |   |        |          |  |
|  | High                          | Action is taken whenever the signal rises above its upper limit.   | 2               |     |      |             |   |                      |   |   |                      |   |   |                      |   |        |          |  |
|  | Abs low                       | Action is taken whenever the absolute value of the signal falls below its (absolute) lower limit.  | 3               |     |      |             |   |                      |   |   |                      |   |   |                      |   |        |          |  |
|  | Abs high                      | Action is taken whenever the absolute value of the signal rises above its (absolute) upper limit.  | 4               |     |      |             |   |                      |   |   |                      |   |   |                      |   |        |          |  |
|  | Both                          | Action is taken whenever the signal falls below its low limit or rises above its high limit.   | 5               |     |      |             |   |                      |   |   |                      |   |   |                      |   |        |          |  |
|  | Abs both                      | Action is taken whenever the absolute value of the signal falls below its (absolute) low limit or rises above its (absolute) high limit.   | 6               |     |      |             |   |                      |   |   |                      |   |   |                      |   |        |          |  |

## 274 Parameters

| No.                   | Name/Value                                | Description  | Def/FbEq16                |
|-----------------------|---|--|---------------------------|
| <a href="#">32.06</a> | <a href="#">Supervision 1 action</a>      | Selects the action the drive takes when the value monitored by signal supervision 1 exceeds its limits.<br><b>Note:</b> This parameter does not affect the status indicated by <a href="#">32.01 Supervision status</a> .  | <a href="#">No action</a> |
|                       | No action                                 | No action taken.   | 0                         |
|                       | Warning                                   | A warning ( <a href="#">A8B0 Signal supervision</a> ) is generated.  | 1                         |
|                       | Fault                                     | The drive trips on <a href="#">80B0 Signal supervision</a> .   | 2                         |
|                       | Fault if running                          | If running, the drive trips on <a href="#">80B0 Signal supervision</a> .   | 3                         |
| <a href="#">32.07</a> | <a href="#">Supervision 1 signal</a>      | Selects the signal to be monitored by signal supervision function 1.   | <a href="#">Zero</a>      |
|                       | Zero                                      | None.  | 0                         |
|                       | Speed                                     | <a href="#">01.01 Motor speed used</a> (page 115).   | 1                         |
|                       | Frequency                                 | <a href="#">01.06 Output frequency</a> (page 115).   | 3                         |
|                       | Current                                   | <a href="#">01.07 Motor current</a> (page 115).  | 4                         |
|                       | Torque                                    | <a href="#">01.10 Motor torque</a> (page 115).   | 6                         |
|                       | DC voltage                                | <a href="#">01.11 DC voltage</a> (page 115).   | 7                         |
|                       | Output power                              | <a href="#">01.14 Output power</a> (page 116).   | 8                         |
|                       | AI1                                       | <a href="#">12.11 AI1 actual value</a> (page 158).   | 9                         |
|                       | AI2                                       | <a href="#">12.21 AI2 actual value</a> (page 160).   | 10                        |
|                       | Speed ref ramp in                         | <a href="#">23.01 Speed ref ramp input</a> (page 218).   | 18                        |
|                       | Speed ref ramp out                        | <a href="#">23.02 Speed ref ramp output</a> (page 218).  | 19                        |
|                       | Speed ref used                            | <a href="#">24.01 Used speed reference</a> (page 224).   | 20                        |
|                       | Torque ref used                           | <a href="#">26.02 Torque reference used</a> (page 240).  | 21                        |
|                       | Freq ref used                             | <a href="#">28.02 Frequency ref ramp output</a> (page 246).  | 22                        |
|                       | Process PID output                        | <a href="#">40.01 Process PID output actual</a> (page 301).  | 24                        |
|                       | Process PID feedback                      | <a href="#">40.02 Process PID feedback actual</a> (page 301).  | 25                        |
|                       | <a href="#">Other</a>                     | Source selection (see <a href="#">Terms and abbreviations</a> on page 112).  | -                         |
| <a href="#">32.08</a> | <a href="#">Supervision 1 filter time</a> | Defines a filter time constant for the signal monitored by signal supervision 1.   | 0.000 s                   |
|                       | 0.000 ... 30.000 s                        | Signal filter time.  | 1000 = 1 s                |
| <a href="#">32.09</a> | <a href="#">Supervision 1 low</a>         | Defines the lower limit for signal supervision 1.  | 0.00                      |
|                       | -21474830.00 ... 21474830.00              | Low limit.   | -                         |
| <a href="#">32.10</a> | <a href="#">Supervision 1 high</a>        | Defines the upper limit for signal supervision 1.  | 0.00                      |
|                       | -21474830.00 ... 21474830.00              | Upper limit.   | -                         |
| <a href="#">32.15</a> | <a href="#">Supervision 2 function</a>    | Selects the mode of signal supervision function 2. Determines how the monitored signal (see parameter <a href="#">32.17</a> ) is compared to its lower and upper limits ( <a href="#">32.19</a> and <a href="#">32.20</a> respectively). The action to be taken when the condition is fulfilled is selected by <a href="#">32.16</a> . | <a href="#">Disabled</a>  |
|                       | Disabled                                  | Signal supervision 2 not in use.   | 0                         |
|                       | Low                                       | Action is taken whenever the signal falls below its lower limit.   | 1                         |
|                       | High                                      | Action is taken whenever the signal rises above its upper limit.   | 2                         |

| No.          | Name/Value                       | Description  | Def/FbEq16       |
|--------------|----------------------------------|--|------------------|
|              | Abs low                          | Action is taken whenever the absolute value of the signal falls below its (absolute) lower limit.  | 3                |
|              | Abs high                         | Action is taken whenever the absolute value of the signal rises above its (absolute) upper limit.  | 4                |
|              | Both                             | Action is taken whenever the signal falls below its low limit or rises above its high limit.   | 5                |
|              | Abs both                         | Action is taken whenever the absolute value of the signal falls below its (absolute) low limit or rises above its (absolute) high limit.   | 6                |
| <b>32.16</b> | <b>Supervision 2 action</b>      | Selects the action the drive takes when the value monitored by signal supervision 2 exceeds its limits.<br><b>Note:</b> This parameter does not affect the status indicated by <a href="#">32.01 Supervision status</a> .  | <i>No action</i> |
|              | No action                        | No action taken.   | 0                |
|              | Warning                          | A warning ( <a href="#">A8B1 Signal supervision 2</a> ) is generated.  | 1                |
|              | Fault                            | The drive trips on <a href="#">80B1 Signal supervision 2</a> .   | 2                |
|              | Fault if running                 | If running, the drive trips on <a href="#">80B0 Signal supervision</a> .   | 3                |
| <b>32.17</b> | <b>Supervision 2 signal</b>      | Selects the signal to be monitored by signal supervision function 2.<br>For the available selections, see parameter <a href="#">32.07 Supervision 1 signal</a> .   | <i>Zero</i>      |
| <b>32.18</b> | <b>Supervision 2 filter time</b> | Defines a filter time constant for the signal monitored by signal supervision 2.   | 0.000 s          |
|              | 0.000 ... 30.000 s               | Signal filter time.  | 1000 = 1 s       |
| <b>32.19</b> | <b>Supervision 2 low</b>         | Defines the lower limit for signal supervision 2.  | 0.00             |
|              | -21474830.00 ... 21474830.00     | Low limit.   | -                |
| <b>32.20</b> | <b>Supervision 2 high</b>        | Defines the upper limit for signal supervision 2.  | 0.00             |
|              | -21474830.00 ... 21474830.00     | Upper limit.   | -                |
| <b>32.25</b> | <b>Supervision 3 function</b>    | Selects the mode of signal supervision function 3. Determines how the monitored signal (see parameter <a href="#">32.27</a> ) is compared to its lower and upper limits ( <a href="#">32.29</a> and <a href="#">32.30</a> respectively). The action to be taken when the condition is fulfilled is selected by <a href="#">32.26</a> . | <i>Disabled</i>  |
|              | Disabled                         | Signal supervision 3 not in use.   | 0                |
|              | Low                              | Action is taken whenever the signal falls below its lower limit.   | 1                |
|              | High                             | Action is taken whenever the signal rises above its upper limit.   | 2                |
|              | Abs low                          | Action is taken whenever the absolute value of the signal falls below its (absolute) lower limit.  | 3                |
|              | Abs high                         | Action is taken whenever the absolute value of the signal rises above its (absolute) upper limit.  | 4                |
|              | Both                             | Action is taken whenever the signal falls below its low limit or rises above its high limit.   | 5                |
|              | Abs both                         | Action is taken whenever the absolute value of the signal falls below its (absolute) low limit or rises above its (absolute) high limit.   | 6                |

| No.   | Name/Value                       | Description   | Def/FbEq16       |
|-------|----------------------------------|---|------------------|
| 32.26 | <i>Supervision 3 action</i>      | Selects the action the drive takes when the value monitored by signal supervision 3 exceeds its limits.<br><b>Note:</b> This parameter does not affect the status indicated by <a href="#">32.01 Supervision status</a> . | <i>No action</i> |
|       | No action                        | No action taken.  | 0                |
|       | Warning                          | A warning ( <a href="#">A8B2 Signal supervision 3</a> ) is generated.   | 1                |
|       | Fault                            | The drive trips on <a href="#">80B2 Signal supervision 3</a> .  | 2                |
|       | Fault if running                 | If running, the drive trips on <a href="#">80B0 Signal supervision</a> .  | 3                |
| 32.27 | <i>Supervision 3 signal</i>      | Selects the signal to be monitored by signal supervision function 3.<br>For the available selections, see parameter <a href="#">32.07 Supervision 1 signal</a> .  | <i>Zero</i>      |
| 32.28 | <i>Supervision 3 filter time</i> | Defines a filter time constant for the signal monitored by signal supervision 3.  | 0.000 s          |
|       | 0.000 ... 30.000 s               | Signal filter time.   | 1000 = 1 s       |
| 32.29 | <i>Supervision 3 low</i>         | Defines the lower limit for signal supervision 3.   | 0.00             |
|       | -21474830.00 ... 21474830.00     | Low limit.  | -                |
| 32.30 | <i>Supervision 3 high</i>        | Defines the upper limit for signal supervision 3.   | 0.00             |
|       | -21474830.00 ... 21474830.00     | Upper limit.  | -                |

|                                       |  |  |
|---------------------------------------|--|--|
| <b>33 Generic timer &amp; counter</b> | Configuration of maintenance timers/counters.<br>See also section <a href="#">Maintenance timers and counters</a> (page 87). |  |
|---------------------------------------|--|--|

|       |                       |  |   |
|-------|-----------------------|--|---|
| 33.01 | <i>Counter status</i> | Displays the maintenance timer/counter status word, indicating which maintenance timers/counters have exceeded their limits.<br>This parameter is read-only. | - |
|-------|-----------------------|--|---|

| Bit    | Name     | Description   |
|--------|----------|---|
| 0      | On-time1 | 1 = On-time timer 1 has reached its preset limit.       |
| 1      | On-time2 | 1 = On-time timer 2 has reached its preset limit.       |
| 2      | Edge 1   | 1 = Signal edge counter 1 has reached its preset limit. |
| 3      | Edge 2   | 1 = Signal edge counter 2 has reached its preset limit. |
| 4      | Value 1  | 1 = Value counter 1 has reached its preset limit.       |
| 5      | Value 2  | 1 = Value counter 2 has reached its preset limit.       |
| 6...15 | Reserved |   |

|                           |                                       |       |
|---------------------------|---------------------------------------|-------|
| 0000 0000b ... 0011 1111b | Maintenance time/counter status word. | 1 = 1 |
|---------------------------|---------------------------------------|-------|

| No.  | Name/Value   | Description   | Def/FbEq16                |     |          |   |  |   |   |        |          |
|--|--|---|---------------------------|-----|----------|---|--|---|---|--------|----------|
| 33.10  | <i>On-time 1 actual</i>  | Displays the actual present value of on-time timer 1.<br>The timer runs whenever the signal selected by parameter <a href="#">33.13 On-time 1 source</a> is on.<br>When the timer exceeds the limit set by <a href="#">33.11 On-time 1 warn limit</a> , bit 0 of <a href="#">33.01 Counter status</a> is set to 1. The warning specified by <a href="#">33.14 On-time 1 warn message</a> is also given if enabled by <a href="#">33.12 On-time 1 function</a> .<br>The timer can be reset from the Drive composer PC tool, or from the control panel by keeping Reset depressed for over 3 seconds. | -                         |     |          |   |  |   |   |        |          |
|  | 0...4294967295 s   | Actual present value of on-time timer 1.  | -                         |     |          |   |  |   |   |        |          |
| 33.11  | <i>On-time 1 warn limit</i>  | Sets the warning limit for on-time timer 1.   | 0 s                       |     |          |   |  |   |   |        |          |
|  | 0...4294967295 s   | Warning limit for on-time timer 1.  | -                         |     |          |   |  |   |   |        |          |
| 33.12  | <i>On-time 1 function</i>  | Configures on-time timer 1.   | 0000b                     |     |          |   |  |   |   |        |          |
| <table border="1"> <thead> <tr> <th>Bit</th> <th>Function</th> </tr> </thead> <tbody> <tr> <td>0</td> <td>Counter mode<br/>0 = Loop: When the limit is reached, the counter is reset. The counter status (bit 0 of <a href="#">33.01</a>) switches to 1 for one second. The warning (if enabled) stays active for at least 10 seconds.<br/>1 = Saturate: When the limit is reached, the counter status (bit 0 of <a href="#">33.01</a>) switches to 1, and remains so until <a href="#">33.10</a> is reset. The warning (if enabled) also stays active until <a href="#">33.10</a> is reset.</td> </tr> <tr> <td>1</td> <td>Warning enable<br/>0 = Disable: No warning is given when the limit is reached<br/>1 = Enable: A warning (see <a href="#">33.14</a>) is given when the limit is reached</td> </tr> <tr> <td>2...15</td> <td>Reserved</td> </tr> </tbody> </table> |  |   |                           | Bit | Function | 0 | Counter mode<br>0 = Loop: When the limit is reached, the counter is reset. The counter status (bit 0 of <a href="#">33.01</a> ) switches to 1 for one second. The warning (if enabled) stays active for at least 10 seconds.<br>1 = Saturate: When the limit is reached, the counter status (bit 0 of <a href="#">33.01</a> ) switches to 1, and remains so until <a href="#">33.10</a> is reset. The warning (if enabled) also stays active until <a href="#">33.10</a> is reset. | 1 | Warning enable<br>0 = Disable: No warning is given when the limit is reached<br>1 = Enable: A warning (see <a href="#">33.14</a> ) is given when the limit is reached | 2...15 | Reserved |
| Bit  | Function   |   |                           |     |          |   |  |   |   |        |          |
| 0  | Counter mode<br>0 = Loop: When the limit is reached, the counter is reset. The counter status (bit 0 of <a href="#">33.01</a> ) switches to 1 for one second. The warning (if enabled) stays active for at least 10 seconds.<br>1 = Saturate: When the limit is reached, the counter status (bit 0 of <a href="#">33.01</a> ) switches to 1, and remains so until <a href="#">33.10</a> is reset. The warning (if enabled) also stays active until <a href="#">33.10</a> is reset. |   |                           |     |          |   |  |   |   |        |          |
| 1  | Warning enable<br>0 = Disable: No warning is given when the limit is reached<br>1 = Enable: A warning (see <a href="#">33.14</a> ) is given when the limit is reached  |   |                           |     |          |   |  |   |   |        |          |
| 2...15   | Reserved   |   |                           |     |          |   |  |   |   |        |          |
|  | 0000b...0011b  | On-time timer 1 configuration word.   | 1 = 1                     |     |          |   |  |   |   |        |          |
| 33.13  | <i>On-time 1 source</i>  | Selects the signal to be monitored by on-time timer 1.  | <i>False</i>              |     |          |   |  |   |   |        |          |
|  | False  | Constant 0 (timer disabled).  | 0                         |     |          |   |  |   |   |        |          |
|  | True   | Constant 1.   | 1                         |     |          |   |  |   |   |        |          |
|  | RO1  | Bit 0 of <a href="#">10.21 RO status</a> (page 149).  | 2                         |     |          |   |  |   |   |        |          |
|  | <i>Other [bit]</i>   | Source selection (see <a href="#">Terms and abbreviations</a> on page 112).   | -                         |     |          |   |  |   |   |        |          |
| 33.14  | <i>On-time 1 warn message</i>  | Selects the optional warning message for on-time timer 1.   | <i>On-time 1 exceeded</i> |     |          |   |  |   |   |        |          |
|  | On-time 1 exceeded   | <a href="#">A886 On-time 1</a> . The message text can be edited on the control panel by choosing Menu – Settings – Edit texts.  | 0                         |     |          |   |  |   |   |        |          |
|  | Clean device   | <a href="#">A88C Device clean</a> .   | 6                         |     |          |   |  |   |   |        |          |
|  | Maintain additional cooling fan  | <a href="#">A890 Additional cooling</a> .   | 7                         |     |          |   |  |   |   |        |          |
|  | Maintain cabinet fan   | <a href="#">A88E Cabinet fan</a> .  | 8                         |     |          |   |  |   |   |        |          |
|  | Maintain DC capacitors   | <a href="#">A88D DC capacitor</a> .   | 9                         |     |          |   |  |   |   |        |          |
|  | Maintain motor bearing   | <a href="#">A880 Motor bearing</a> .  | 10                        |     |          |   |  |   |   |        |          |

| No.  | Name/Value   | Description   | Def/FbEq16                |     |          |   |  |   |   |        |          |
|--|--|---|---------------------------|-----|----------|---|--|---|---|--------|----------|
| 33.20  | <i>On-time 2 actual</i>  | Displays the actual present value of on-time timer 2.<br>The timer runs whenever the signal selected by parameter <a href="#">33.23 On-time 2 source</a> is on.<br>When the timer exceeds the limit set by <a href="#">33.21 On-time 2 warn limit</a> , bit 1 of <a href="#">33.01 Counter status</a> is set to 1. The warning specified by <a href="#">33.24 On-time 2 warn message</a> is also given if enabled by <a href="#">33.22 On-time 2 function</a> .<br>The timer can be reset from the Drive composer PC tool, or from the control panel by keeping Reset depressed for over 3 seconds. | -                         |     |          |   |  |   |   |        |          |
|  | 0...4294967295 s   | Actual present value of on-time timer 2.  | -                         |     |          |   |  |   |   |        |          |
| 33.21  | <i>On-time 2 warn limit</i>  | Sets the warning limit for on-time timer 2.   | 0 s                       |     |          |   |  |   |   |        |          |
|  | 0...4294967295 s   | Warning limit for on-time timer 2.  | -                         |     |          |   |  |   |   |        |          |
| 33.22  | <i>On-time 2 function</i>  | Configures on-time timer 2.   | 0000b                     |     |          |   |  |   |   |        |          |
| <table border="1"> <thead> <tr> <th>Bit</th> <th>Function</th> </tr> </thead> <tbody> <tr> <td>0</td> <td>Counter mode<br/>0 = Loop: When the limit is reached, the counter is reset. The counter status (bit 1 of <a href="#">33.01</a>) switches to 1 for one second. The warning (if enabled) stays active for at least 10 seconds.<br/>1 = Saturate: When the limit is reached, the counter status (bit 1 of <a href="#">33.01</a>) switches to 1, and remains so until <a href="#">33.20</a> is reset. The warning (if enabled) also stays active until <a href="#">33.20</a> is reset.</td> </tr> <tr> <td>1</td> <td>Warning enable<br/>0 = Disable: No warning is given when the limit is reached<br/>1 = Enable: A warning (see <a href="#">33.24</a>) is given when the limit is reached</td> </tr> <tr> <td>2...15</td> <td>Reserved</td> </tr> </tbody> </table> |  |   |                           | Bit | Function | 0 | Counter mode<br>0 = Loop: When the limit is reached, the counter is reset. The counter status (bit 1 of <a href="#">33.01</a> ) switches to 1 for one second. The warning (if enabled) stays active for at least 10 seconds.<br>1 = Saturate: When the limit is reached, the counter status (bit 1 of <a href="#">33.01</a> ) switches to 1, and remains so until <a href="#">33.20</a> is reset. The warning (if enabled) also stays active until <a href="#">33.20</a> is reset. | 1 | Warning enable<br>0 = Disable: No warning is given when the limit is reached<br>1 = Enable: A warning (see <a href="#">33.24</a> ) is given when the limit is reached | 2...15 | Reserved |
| Bit  | Function   |   |                           |     |          |   |  |   |   |        |          |
| 0  | Counter mode<br>0 = Loop: When the limit is reached, the counter is reset. The counter status (bit 1 of <a href="#">33.01</a> ) switches to 1 for one second. The warning (if enabled) stays active for at least 10 seconds.<br>1 = Saturate: When the limit is reached, the counter status (bit 1 of <a href="#">33.01</a> ) switches to 1, and remains so until <a href="#">33.20</a> is reset. The warning (if enabled) also stays active until <a href="#">33.20</a> is reset. |   |                           |     |          |   |  |   |   |        |          |
| 1  | Warning enable<br>0 = Disable: No warning is given when the limit is reached<br>1 = Enable: A warning (see <a href="#">33.24</a> ) is given when the limit is reached  |   |                           |     |          |   |  |   |   |        |          |
| 2...15   | Reserved   |   |                           |     |          |   |  |   |   |        |          |
|  | 0000b...0011b  | On-time timer 2 configuration word.   | 1 = 1                     |     |          |   |  |   |   |        |          |
| 33.23  | <i>On-time 2 source</i>  | Selects the signal to be monitored by on-time timer 2.  | <i>False</i>              |     |          |   |  |   |   |        |          |
|  | False  | Constant 0 (timer disabled).  | 0                         |     |          |   |  |   |   |        |          |
|  | True   | Constant 1.   | 1                         |     |          |   |  |   |   |        |          |
|  | RO1  | Bit 0 of <a href="#">10.21 RO status</a> (page 149).  | 2                         |     |          |   |  |   |   |        |          |
|  | <i>Other [bit]</i>   | Source selection (see <a href="#">Terms and abbreviations</a> on page 112).   | -                         |     |          |   |  |   |   |        |          |
| 33.24  | <i>On-time 2 warn message</i>  | Selects the optional warning message for on-time timer 2.   | <i>On-time 2 exceeded</i> |     |          |   |  |   |   |        |          |
|  | On-time 2 exceeded   | <a href="#">A887 On-time 2</a> . The message text can be edited on the control panel by choosing Menu – Settings – Edit texts.  | 1                         |     |          |   |  |   |   |        |          |
|  | Clean device   | <a href="#">A88C Device clean</a> .   | 6                         |     |          |   |  |   |   |        |          |
|  | Maintain additional cool fan   | <a href="#">A890 Additional cooling</a> .   | 7                         |     |          |   |  |   |   |        |          |
|  | Maintain cabinet fan   | <a href="#">A88E Cabinet fan</a> .  | 8                         |     |          |   |  |   |   |        |          |
|  | Maintain DC capacitors   | <a href="#">A88D DC capacitor</a> .   | 9                         |     |          |   |  |   |   |        |          |
|  | Maintain motor bearing   | <a href="#">A880 Motor bearing</a> .  | 10                        |     |          |   |  |   |   |        |          |

| No.    | Name/Value  | Description  | Def/FbEq16   |          |   |   |   |   |   |   |   |  |        |          |  |
|--------|---|--|--------------|----------|---|---|---|---|---|---|---|--|--------|----------|--|
| 33.30  | <a href="#">Edge counter 1 actual</a>   | Actual present value of signal edge counter 1.<br>The counter is incremented every time the signal selected by parameter <a href="#">33.33 Edge counter 1 source</a> switches on or off (or either, depending on the setting of <a href="#">33.32 Edge counter 1 function</a> ). A divisor may be applied to the count (see <a href="#">33.34 Edge counter 1 divider</a> ).<br>When the counter exceeds the limit set by <a href="#">33.31 Edge counter 1 warn limit</a> , bit 2 of <a href="#">33.01 Counter status</a> is set to 1. The warning specified by <a href="#">33.35 Edge counter 1 warn message</a> is also given if enabled by <a href="#">33.32 Edge counter 1 function</a> .<br>The counter can be reset from the Drive composer PC tool, or from the control panel by keeping Reset depressed for over 3 seconds.   | -            |          |   |   |   |   |   |   |   |  |        |          |  |
|        | 0...4294967295  | Actual present value of signal edge counter 1.   | -            |          |   |   |   |   |   |   |   |  |        |          |  |
| 33.31  | <a href="#">Edge counter 1 warn limit</a>   | Sets the warning limit for signal edge counter 1.  | 0            |          |   |   |   |   |   |   |   |  |        |          |  |
|        | 0...4294967295  | Warning limit for signal edge counter 1.   | -            |          |   |   |   |   |   |   |   |  |        |          |  |
| 33.32  | <a href="#">Edge counter 1 function</a>   | Configures signal edge counter 1.  | 0000b        |          |   |   |   |   |   |   |   |  |        |          |  |
|        |   | <table border="1"> <thead> <tr> <th>Bit</th> <th>Function</th> </tr> </thead> <tbody> <tr> <td>0</td> <td>Counter mode<br/>0 = Loop: When the limit is reached, the counter is reset. The counter status (bit 2 of <a href="#">33.01</a>) switches to 1 and remains so until the counter is again incremented. The warning (if enabled) stays active for at least 10 seconds.<br/>1 = Saturate: When the limit is reached, the counter status (bit 2 of <a href="#">33.01</a>) switches to 1, and remains so until <a href="#">33.30</a> is reset. The warning (if enabled) also stays active until <a href="#">33.30</a> is reset.</td> </tr> <tr> <td>1</td> <td>Warning enable<br/>0 = Disable: No warning is given when the limit is reached<br/>1 = Enable: A warning (see <a href="#">33.35</a>) is given when the limit is reached</td> </tr> <tr> <td>2</td> <td>Count rising edges<br/>0 = Disable: Rising edges are not counted<br/>1 = Enable: Rising edges are counted</td> </tr> <tr> <td>3</td> <td>Count falling edges<br/>0 = Disable: Falling edges are not counted<br/>1 = Enable: Falling edges are counted</td> </tr> <tr> <td>4...15</td> <td>Reserved</td> </tr> </tbody> </table> | Bit          | Function | 0 | Counter mode<br>0 = Loop: When the limit is reached, the counter is reset. The counter status (bit 2 of <a href="#">33.01</a> ) switches to 1 and remains so until the counter is again incremented. The warning (if enabled) stays active for at least 10 seconds.<br>1 = Saturate: When the limit is reached, the counter status (bit 2 of <a href="#">33.01</a> ) switches to 1, and remains so until <a href="#">33.30</a> is reset. The warning (if enabled) also stays active until <a href="#">33.30</a> is reset. | 1 | Warning enable<br>0 = Disable: No warning is given when the limit is reached<br>1 = Enable: A warning (see <a href="#">33.35</a> ) is given when the limit is reached | 2 | Count rising edges<br>0 = Disable: Rising edges are not counted<br>1 = Enable: Rising edges are counted | 3 | Count falling edges<br>0 = Disable: Falling edges are not counted<br>1 = Enable: Falling edges are counted | 4...15 | Reserved |  |
| Bit    | Function  |  |              |          |   |   |   |   |   |   |   |  |        |          |  |
| 0      | Counter mode<br>0 = Loop: When the limit is reached, the counter is reset. The counter status (bit 2 of <a href="#">33.01</a> ) switches to 1 and remains so until the counter is again incremented. The warning (if enabled) stays active for at least 10 seconds.<br>1 = Saturate: When the limit is reached, the counter status (bit 2 of <a href="#">33.01</a> ) switches to 1, and remains so until <a href="#">33.30</a> is reset. The warning (if enabled) also stays active until <a href="#">33.30</a> is reset. |  |              |          |   |   |   |   |   |   |   |  |        |          |  |
| 1      | Warning enable<br>0 = Disable: No warning is given when the limit is reached<br>1 = Enable: A warning (see <a href="#">33.35</a> ) is given when the limit is reached   |  |              |          |   |   |   |   |   |   |   |  |        |          |  |
| 2      | Count rising edges<br>0 = Disable: Rising edges are not counted<br>1 = Enable: Rising edges are counted   |  |              |          |   |   |   |   |   |   |   |  |        |          |  |
| 3      | Count falling edges<br>0 = Disable: Falling edges are not counted<br>1 = Enable: Falling edges are counted  |  |              |          |   |   |   |   |   |   |   |  |        |          |  |
| 4...15 | Reserved  |  |              |          |   |   |   |   |   |   |   |  |        |          |  |
|        | 0000b...1111b   | Edge counter 1 configuration word.   | 1 = 1        |          |   |   |   |   |   |   |   |  |        |          |  |
| 33.33  | <a href="#">Edge counter 1 source</a>   | Selects the signal to be monitored by signal edge counter 1.   | <i>False</i> |          |   |   |   |   |   |   |   |  |        |          |  |
|        | False   | Constant 0.  | 0            |          |   |   |   |   |   |   |   |  |        |          |  |
|        | True  | Constant 1.  | 1            |          |   |   |   |   |   |   |   |  |        |          |  |
|        | RO1   | Bit 0 of <a href="#">10.21 RO status</a> (page 149).   | 2            |          |   |   |   |   |   |   |   |  |        |          |  |
|        | <i>Other [bit]</i>  | Source selection (see <a href="#">Terms and abbreviations</a> on page 112).  | -            |          |   |   |   |   |   |   |   |  |        |          |  |
| 33.34  | <a href="#">Edge counter 1 divider</a>  | Defines a divisor for signal edge counter 1. Determines how many signal edges increment the counter by 1.  | 1            |          |   |   |   |   |   |   |   |  |        |          |  |
|        | 1...4294967295  | Divisor for signal edge counter 1.   | -            |          |   |   |   |   |   |   |   |  |        |          |  |



| No.  | Name/Value  | Description  | Def/FbEq16                              |     |          |   |   |   |   |   |   |   |  |        |          |
|--|---|--|---|-----|----------|---|---|---|---|---|---|---|--|--------|----------|
| 33.35  | <a href="#">Edge counter 1 warn message</a>   | Selects the optional warning message for signal edge counter 1.  | <a href="#">Edge counter 1 exceeded</a> |     |          |   |   |   |   |   |   |   |  |        |          |
|  | Edge counter 1 exceeded   | <a href="#">A888 Edge counter 1</a> . The message text can be edited on the control panel by choosing Menu – Settings – Edit texts.  | 2                                       |     |          |   |   |   |   |   |   |   |  |        |          |
|  | Counted main contactor  | <a href="#">A884 Main contactor</a> .  | 11                                      |     |          |   |   |   |   |   |   |   |  |        |          |
|  | Counted output relay  | <a href="#">A881 Output relay</a> .  | 12                                      |     |          |   |   |   |   |   |   |   |  |        |          |
|  | Counted motor starts  | <a href="#">A882 Motor starts</a> .  | 13                                      |     |          |   |   |   |   |   |   |   |  |        |          |
|  | Counted power ups   | <a href="#">A883 Power ups</a> .   | 14                                      |     |          |   |   |   |   |   |   |   |  |        |          |
|  | Counted DC charges  | <a href="#">A885 DC charge</a> .   | 15                                      |     |          |   |   |   |   |   |   |   |  |        |          |
| 33.40  | <a href="#">Edge counter 2 actual</a>   | Displays the actual present value of signal edge counter 2. The counter is incremented every time the signal selected by parameter <a href="#">33.43 Edge counter 2 source</a> switches on or off (or either, depending on the setting of <a href="#">33.42 Edge counter 2 function</a> ). A divisor may be applied to the count (see <a href="#">33.44 Edge counter 2 divider</a> ).<br>When the counter exceeds the limit set by <a href="#">33.41 Edge counter 2 warn limit</a> , bit 3 of <a href="#">33.01 Counter status</a> is set to 1. The warning specified by <a href="#">33.45 Edge counter 2 warn message</a> is also given if enabled by <a href="#">33.42 Edge counter 2 function</a> .<br>The counter can be reset from the Drive composer PC tool, or from the control panel by keeping Reset depressed for over 3 seconds. | -                                       |     |          |   |   |   |   |   |   |   |  |        |          |
|  | 0...4294967295  | Actual present value of signal edge counter 2.   | -                                       |     |          |   |   |   |   |   |   |   |  |        |          |
| 33.41  | <a href="#">Edge counter 2 warn limit</a>   | Sets the warning limit for signal edge counter 2.  | 0                                       |     |          |   |   |   |   |   |   |   |  |        |          |
|  | 0...4294967295  | Warning limit for signal edge counter 2.   | -                                       |     |          |   |   |   |   |   |   |   |  |        |          |
| 33.42  | <a href="#">Edge counter 2 function</a>   | Configures signal edge counter 2.  | 0000b                                   |     |          |   |   |   |   |   |   |   |  |        |          |
| <table border="1"> <thead> <tr> <th>Bit</th> <th>Function</th> </tr> </thead> <tbody> <tr> <td>0</td> <td>Counter mode<br/>0 = Loop: When the limit is reached, the counter is reset. The counter status (bit 3 of <a href="#">33.01</a>) remains 1 until the counter is again incremented. The warning (if enabled) stays active for at least 10 seconds.<br/>1 = Saturate: After the limit is reached, the counter status (bit 3 of <a href="#">33.01</a>) remains 1 until <a href="#">33.40</a> is reset. The warning (if enabled) also stays active until <a href="#">33.40</a> is reset.</td> </tr> <tr> <td>1</td> <td>Warning enable<br/>0 = Disable: No warning is given when the limit is reached<br/>1 = Enable: A warning (see <a href="#">33.45</a>) is given when the limit is reached</td> </tr> <tr> <td>2</td> <td>Count rising edges<br/>0 = Disable: Rising edges are not counted<br/>1 = Enable: Rising edges are counted</td> </tr> <tr> <td>3</td> <td>Count falling edges<br/>0 = Disable: Falling edges are not counted<br/>1 = Enable: Falling edges are counted</td> </tr> <tr> <td>4...15</td> <td>Reserved</td> </tr> </tbody> </table> |   |  |   | Bit | Function | 0 | Counter mode<br>0 = Loop: When the limit is reached, the counter is reset. The counter status (bit 3 of <a href="#">33.01</a> ) remains 1 until the counter is again incremented. The warning (if enabled) stays active for at least 10 seconds.<br>1 = Saturate: After the limit is reached, the counter status (bit 3 of <a href="#">33.01</a> ) remains 1 until <a href="#">33.40</a> is reset. The warning (if enabled) also stays active until <a href="#">33.40</a> is reset. | 1 | Warning enable<br>0 = Disable: No warning is given when the limit is reached<br>1 = Enable: A warning (see <a href="#">33.45</a> ) is given when the limit is reached | 2 | Count rising edges<br>0 = Disable: Rising edges are not counted<br>1 = Enable: Rising edges are counted | 3 | Count falling edges<br>0 = Disable: Falling edges are not counted<br>1 = Enable: Falling edges are counted | 4...15 | Reserved |
| Bit  | Function  |  |   |     |          |   |   |   |   |   |   |   |  |        |          |
| 0  | Counter mode<br>0 = Loop: When the limit is reached, the counter is reset. The counter status (bit 3 of <a href="#">33.01</a> ) remains 1 until the counter is again incremented. The warning (if enabled) stays active for at least 10 seconds.<br>1 = Saturate: After the limit is reached, the counter status (bit 3 of <a href="#">33.01</a> ) remains 1 until <a href="#">33.40</a> is reset. The warning (if enabled) also stays active until <a href="#">33.40</a> is reset. |  |   |     |          |   |   |   |   |   |   |   |  |        |          |
| 1  | Warning enable<br>0 = Disable: No warning is given when the limit is reached<br>1 = Enable: A warning (see <a href="#">33.45</a> ) is given when the limit is reached   |  |   |     |          |   |   |   |   |   |   |   |  |        |          |
| 2  | Count rising edges<br>0 = Disable: Rising edges are not counted<br>1 = Enable: Rising edges are counted   |  |   |     |          |   |   |   |   |   |   |   |  |        |          |
| 3  | Count falling edges<br>0 = Disable: Falling edges are not counted<br>1 = Enable: Falling edges are counted  |  |   |     |          |   |   |   |   |   |   |   |  |        |          |
| 4...15   | Reserved  |  |   |     |          |   |   |   |   |   |   |   |  |        |          |
|  | 0000b...1111b   | Edge counter 2 configuration word.   | 1 = 1                                   |     |          |   |   |   |   |   |   |   |  |        |          |



| No.   | Name/Value                                  | Description   | Def/FbEq16                              |
|-------|---|---|---|
| 33.43 | <a href="#">Edge counter 2 source</a>       | Selects the signal to be monitored by signal edge counter 2.  | <a href="#">False</a>                   |
|       | False                                       | 0.  | 0                                       |
|       | True  | 1.  | 1                                       |
|       | RO1   | Bit 0 of <a href="#">10.21 RO status</a> (page 149).  | 2                                       |
|       | <a href="#">Other [bit]</a>                 | Source selection (see <a href="#">Terms and abbreviations</a> on page 112).   | -                                       |
| 33.44 | <a href="#">Edge counter 2 divider</a>      | Defines a divisor for signal edge counter 2. Determines how many signal edges increment the counter by 1.   | 1                                       |
|       | 1...4294967295                              | Divisor for signal edge counter 2.  | -                                       |
| 33.45 | <a href="#">Edge counter 2 warn message</a> | Selects the optional warning message for signal edge counter 2.   | <a href="#">Edge counter 2 exceeded</a> |
|       | Edge counter 2 exceeded                     | <a href="#">A889 Edge counter 2</a> . The message text can be edited on the control panel by choosing Menu – Settings – Edit texts.   | 3                                       |
|       | Counted main contactor                      | <a href="#">A884 Main contactor</a> .   | 11                                      |
|       | Counted output relay                        | <a href="#">A881 Output relay</a> .   | 12                                      |
|       | Counted motor starts                        | <a href="#">A882 Motor starts</a> .   | 13                                      |
|       | Counted power ups                           | <a href="#">A883 Power ups</a> .  | 14                                      |
|       | Counted DC charges                          | <a href="#">A885 DC charge</a> .  | 15                                      |
| 33.50 | <a href="#">Value counter 1 actual</a>      | Displays the actual present value of value counter 1.<br>The value of the source selected by parameter <a href="#">33.53 Value counter 1 source</a> is read at one-second intervals and added to the counter. A divisor can be applied to the count (see <a href="#">33.54 Value counter 1 divider</a> ).<br>When the counter exceeds the limit set by <a href="#">33.51 Value counter 1 warn limit</a> , bit 4 of <a href="#">33.01 Counter status</a> is set to 1. The warning specified by <a href="#">33.55 Value counter 1 warn message</a> is also given if enabled by <a href="#">33.52 Value counter 1 function</a> .<br>The counter can be reset from the Drive composer PC tool, or from the control panel by keeping Reset depressed for over 3 seconds. | -                                       |
|       | -2147483008 ...<br>2147483008               | Actual present value of value counter 1.  | -                                       |
| 33.51 | <a href="#">Value counter 1 warn limit</a>  | Sets the limit for value counter 1.<br>With a positive limit, bit 4 of <a href="#">33.01 Counter status</a> is set to 1 (and a warning optionally generated) when the counter is equal or greater than the limit.<br>With a negative limit, bit 4 of <a href="#">33.01 Counter status</a> is set to 1 (and a warning optionally generated) when the counter is equal or smaller than the limit.<br>0 = Counter disabled.  | 0                                       |
|       | -2147483008 ...<br>2147483008               | Limit for value counter 1.  | -                                       |

| No.    | Name/Value   | Description  | Def/FbEq16                      |          |   |  |   |   |        |          |  |
|--------|--|--|---------------------------------|----------|---|--|---|---|--------|----------|--|
| 33.52  | <i>Value counter 1 function</i>  | Configures value counter 1.  | 0000b                           |          |   |  |   |   |        |          |  |
|        |  | <table border="1"> <thead> <tr> <th>Bit</th> <th>Function</th> </tr> </thead> <tbody> <tr> <td>0</td> <td>Counter mode<br/>0 = Loop: When the limit is reached, the counter is reset. The counter status (bit 4 of <a href="#">33.01</a>) switches to 1 for one second. The warning (if enabled) stays active for at least 10 seconds.<br/>1 = Saturate: When the limit is reached, the counter status (bit 4 of <a href="#">33.01</a>) switches to 1, and remains so until <a href="#">33.50</a> is reset. The warning (if enabled) also stays active until <a href="#">33.50</a> is reset.</td> </tr> <tr> <td>1</td> <td>Warning enable<br/>0 = Disable: No warning is given when the limit is reached<br/>1 = Enable: A warning (see <a href="#">33.55</a>) is given when the limit is reached</td> </tr> <tr> <td>2...15</td> <td>Reserved</td> </tr> </tbody> </table> | Bit                             | Function | 0 | Counter mode<br>0 = Loop: When the limit is reached, the counter is reset. The counter status (bit 4 of <a href="#">33.01</a> ) switches to 1 for one second. The warning (if enabled) stays active for at least 10 seconds.<br>1 = Saturate: When the limit is reached, the counter status (bit 4 of <a href="#">33.01</a> ) switches to 1, and remains so until <a href="#">33.50</a> is reset. The warning (if enabled) also stays active until <a href="#">33.50</a> is reset. | 1 | Warning enable<br>0 = Disable: No warning is given when the limit is reached<br>1 = Enable: A warning (see <a href="#">33.55</a> ) is given when the limit is reached | 2...15 | Reserved |  |
| Bit    | Function   |  |                                 |          |   |  |   |   |        |          |  |
| 0      | Counter mode<br>0 = Loop: When the limit is reached, the counter is reset. The counter status (bit 4 of <a href="#">33.01</a> ) switches to 1 for one second. The warning (if enabled) stays active for at least 10 seconds.<br>1 = Saturate: When the limit is reached, the counter status (bit 4 of <a href="#">33.01</a> ) switches to 1, and remains so until <a href="#">33.50</a> is reset. The warning (if enabled) also stays active until <a href="#">33.50</a> is reset. |  |                                 |          |   |  |   |   |        |          |  |
| 1      | Warning enable<br>0 = Disable: No warning is given when the limit is reached<br>1 = Enable: A warning (see <a href="#">33.55</a> ) is given when the limit is reached  |  |                                 |          |   |  |   |   |        |          |  |
| 2...15 | Reserved   |  |                                 |          |   |  |   |   |        |          |  |
|        | 0000b...0011b  | Value counter 1 configuration word.  | 1 = 1                           |          |   |  |   |   |        |          |  |
| 33.53  | <i>Value counter 1 source</i>  | Selects the signal to be monitored by value counter 1.   | <i>Not selected</i>             |          |   |  |   |   |        |          |  |
|        | Not selected   | None (counter disabled).   | 0                               |          |   |  |   |   |        |          |  |
|        | Motor speed  | <a href="#">01.01 Motor speed used</a> (see page <a href="#">115</a> ).  | 1                               |          |   |  |   |   |        |          |  |
|        | <i>Other</i>   | Source selection (see <a href="#">Terms and abbreviations</a> on page <a href="#">112</a> ).   | -                               |          |   |  |   |   |        |          |  |
| 33.54  | <i>Value counter 1 divider</i>   | Defines a divisor for value counter 1. The value of the monitored signal is divided by this value before integration.  | 1.000                           |          |   |  |   |   |        |          |  |
|        | 0.001 ...<br>2147483.000   | Divisor for value counter 1.   | -                               |          |   |  |   |   |        |          |  |
| 33.55  | <i>Value counter 1 warn message</i>  | Selects the optional warning message for value counter 1.  | <i>Value counter 1 exceeded</i> |          |   |  |   |   |        |          |  |
|        | Value counter 1 exceeded   | <a href="#">A88A Value counter 1</a> . The message text can be edited on the control panel by choosing Menu – Settings – Edit texts.   | 4                               |          |   |  |   |   |        |          |  |
|        | Maintain motor bearing   | <a href="#">A880 Motor bearing</a> .   | 10                              |          |   |  |   |   |        |          |  |
| 33.60  | <i>Value counter 2 actual</i>  | Displays the actual present value of value counter 2.<br>The value of the source selected by parameter <a href="#">33.63 Value counter 2 source</a> is read at one-second intervals and added to the counter. A divisor can be applied to the count (see <a href="#">33.64 Value counter 2 divider</a> ).<br>When the counter exceeds the limit set by <a href="#">33.61 Value counter 2 warn limit</a> , bit 5 of <a href="#">33.01 Counter status</a> is set to 1. The warning specified by <a href="#">33.65 Value counter 2 warn message</a> is also given if enabled by <a href="#">33.62 Value counter 2 function</a> .<br>The counter can be reset from the Drive composer PC tool, or from the control panel by keeping Reset depressed for over 3 seconds.  | -                               |          |   |  |   |   |        |          |  |
|        | -2147483008 ...<br>2147483008  | Actual present value of value counter 2.   | -                               |          |   |  |   |   |        |          |  |

| No.    | Name/Value   | Description   | Def/FbEq16                      |          |   |  |   |  |        |          |  |
|--------|--|---|---------------------------------|----------|---|--|---|--|--------|----------|--|
| 33.61  | <i>Value counter 2 warn limit</i>  | Sets the limit for value counter 2.<br>With a positive limit, bit 5 of <i>33.01 Counter status</i> is set to 1 (and a warning optionally generated) when the counter is equal or greater than the limit.<br>With a negative limit, bit 5 of <i>33.01 Counter status</i> is set to 1 (and a warning optionally generated) when the counter is equal or smaller than the limit.<br>0 = Counter disabled.  | 0                               |          |   |  |   |  |        |          |  |
|        | -2147483008 ...<br>2147483008  | Limit for value counter 2.  | -                               |          |   |  |   |  |        |          |  |
| 33.62  | <i>Value counter 2 function</i>  | Configures value counter 2.   | 0000b                           |          |   |  |   |  |        |          |  |
|        |  | <table border="1"> <thead> <tr> <th>Bit</th> <th>Function</th> </tr> </thead> <tbody> <tr> <td>0</td> <td>Counter mode<br/>0 = Loop: When the limit is reached, the counter is reset. The counter status (bit 5 of <i>33.01</i>) switches to 1 for one second. The warning (if enabled) stays active for at least 10 seconds.<br/>1 = Saturate: When the limit is reached, the counter status (bit 5 of <i>33.01</i>) switches to 1, and remains so until <i>33.60</i> is reset. The warning (if enabled) also stays active until <i>33.60</i> is reset.</td> </tr> <tr> <td>1</td> <td>Warning enable<br/>0 = Disable: No warning is given when the limit is reached<br/>1 = Enable: A warning (see <i>33.65</i>) is given when the limit is reached</td> </tr> <tr> <td>2...15</td> <td>Reserved</td> </tr> </tbody> </table> | Bit                             | Function | 0 | Counter mode<br>0 = Loop: When the limit is reached, the counter is reset. The counter status (bit 5 of <i>33.01</i> ) switches to 1 for one second. The warning (if enabled) stays active for at least 10 seconds.<br>1 = Saturate: When the limit is reached, the counter status (bit 5 of <i>33.01</i> ) switches to 1, and remains so until <i>33.60</i> is reset. The warning (if enabled) also stays active until <i>33.60</i> is reset. | 1 | Warning enable<br>0 = Disable: No warning is given when the limit is reached<br>1 = Enable: A warning (see <i>33.65</i> ) is given when the limit is reached | 2...15 | Reserved |  |
| Bit    | Function   |   |                                 |          |   |  |   |  |        |          |  |
| 0      | Counter mode<br>0 = Loop: When the limit is reached, the counter is reset. The counter status (bit 5 of <i>33.01</i> ) switches to 1 for one second. The warning (if enabled) stays active for at least 10 seconds.<br>1 = Saturate: When the limit is reached, the counter status (bit 5 of <i>33.01</i> ) switches to 1, and remains so until <i>33.60</i> is reset. The warning (if enabled) also stays active until <i>33.60</i> is reset. |   |                                 |          |   |  |   |  |        |          |  |
| 1      | Warning enable<br>0 = Disable: No warning is given when the limit is reached<br>1 = Enable: A warning (see <i>33.65</i> ) is given when the limit is reached   |   |                                 |          |   |  |   |  |        |          |  |
| 2...15 | Reserved   |   |                                 |          |   |  |   |  |        |          |  |
|        | 0000b...0011b  | Value counter 2 configuration word.   | 1 = 1                           |          |   |  |   |  |        |          |  |
| 33.63  | <i>Value counter 2 source</i>  | Selects the signal to be monitored by value counter 2.  | <i>Not selected</i>             |          |   |  |   |  |        |          |  |
|        | Not selected   | None (counter disabled).  | 0                               |          |   |  |   |  |        |          |  |
|        | Motor speed  | <i>01.01 Motor speed used</i> (see page 115).   | 1                               |          |   |  |   |  |        |          |  |
|        | <i>Other</i>   | Source selection (see <i>Terms and abbreviations</i> on page 112).  | -                               |          |   |  |   |  |        |          |  |
| 33.64  | <i>Value counter 2 divider</i>   | Defines a divisor for value counter 2. The value of the monitored signal is divided by this value before integration.   | 1.000                           |          |   |  |   |  |        |          |  |
|        | 0.001 ...<br>2147483.000   | Divisor for value counter 2.  | -                               |          |   |  |   |  |        |          |  |
| 33.65  | <i>Value counter 2 warn message</i>  | Selects the optional warning message for value counter 2.   | <i>Value counter 2 exceeded</i> |          |   |  |   |  |        |          |  |
|        | Value counter 2 exceeded   | <i>A88B Value counter 2</i> . The message text can be edited on the control panel by choosing Menu – Settings – Edit texts.   | 5                               |          |   |  |   |  |        |          |  |
|        | Maintain motor bearing   | <i>A880 Motor bearing</i> .   | 10                              |          |   |  |   |  |        |          |  |

| No.                                | Name/Value                                       | Description  | Def/FbEq16 |      |             |   |                        |   |   |                        |   |   |                          |   |   |                        |   |   |                        |   |   |                          |   |   |                        |   |   |                        |   |   |                          |   |        |          |  |  |
|------------------------------------|--|--|------------|------|-------------|---|------------------------|---|---|------------------------|---|---|--------------------------|---|---|------------------------|---|---|------------------------|---|---|--------------------------|---|---|------------------------|---|---|------------------------|---|---|--------------------------|---|--------|----------|--|--|
| <b>35 Motor thermal protection</b> |  | Motor thermal protection settings such as temperature measurement configuration, load curve definition and motor fan control configuration.<br>See also section <a href="#">Motor thermal protection</a> (page 80).  |            |      |             |   |                        |   |   |                        |   |   |                          |   |   |                        |   |   |                        |   |   |                          |   |   |                        |   |   |                        |   |   |                          |   |        |          |  |  |
| 35.01                              | <i>Motor estimated temperature</i>               | Displays the motor temperature as estimated by the internal motor thermal protection model (see parameters <a href="#">35.50...35.55</a> ). The unit is selected by parameter <a href="#">96.16 Unit selection</a> .<br>This parameter is read-only.   | -          |      |             |   |                        |   |   |                        |   |   |                          |   |   |                        |   |   |                        |   |   |                          |   |   |                        |   |   |                        |   |   |                          |   |        |          |  |  |
|                                    | -60 ... 1000 °C or °F                            | Estimated motor temperature.   | 1 = 1°     |      |             |   |                        |   |   |                        |   |   |                          |   |   |                        |   |   |                        |   |   |                          |   |   |                        |   |   |                        |   |   |                          |   |        |          |  |  |
| 35.02                              | <i>Measured temperature 1</i>                    | Displays the temperature received through the source defined by parameter <a href="#">35.11 Temperature 1 source</a> . The unit is selected by parameter <a href="#">96.16 Unit selection</a> .<br><b>Note:</b> With a PTC sensor, the unit is ohms.<br>This parameter is read-only.   | -          |      |             |   |                        |   |   |                        |   |   |                          |   |   |                        |   |   |                        |   |   |                          |   |   |                        |   |   |                        |   |   |                          |   |        |          |  |  |
|                                    | -60 ... 1000 °C, -76 ... 1832 °F or 0...5000 ohm | Measured temperature 1.  | 1 = 1 unit |      |             |   |                        |   |   |                        |   |   |                          |   |   |                        |   |   |                        |   |   |                          |   |   |                        |   |   |                        |   |   |                          |   |        |          |  |  |
| 35.03                              | <i>Measured temperature 2</i>                    | Displays the temperature received through the source defined by parameter <a href="#">35.21 Temperature 2 source</a> . The unit is selected by parameter <a href="#">96.16 Unit selection</a> .<br><b>Note:</b> With a PTC sensor, the unit is ohms.<br>This parameter is read-only.   | -          |      |             |   |                        |   |   |                        |   |   |                          |   |   |                        |   |   |                        |   |   |                          |   |   |                        |   |   |                        |   |   |                          |   |        |          |  |  |
|                                    | -60 ... 1000 °C, -76 ... 1832 °F or 0...5000 ohm | Measured temperature 2.  | 1 = 1 unit |      |             |   |                        |   |   |                        |   |   |                          |   |   |                        |   |   |                        |   |   |                          |   |   |                        |   |   |                        |   |   |                          |   |        |          |  |  |
| 35.04                              | <i>FPTC status word</i>                          | Displays the status of optional FPTC-xx thermistor protection modules. The word can be used as the source of eg. external events.<br><b>Note:</b> The “module found” bits are updated regardless of whether the corresponding module is activated. However, the “fault active” and “warning active” bits are not updated if the module is not activated. Modules are activated by parameter <a href="#">35.30 FPTC configuration word</a> .<br>This parameter is read-only.  | -          |      |             |   |                        |   |   |                        |   |   |                          |   |   |                        |   |   |                        |   |   |                          |   |   |                        |   |   |                        |   |   |                          |   |        |          |  |  |
|                                    |  | <table border="1"> <thead> <tr> <th>Bit</th> <th>Name</th> <th>Description</th> </tr> </thead> <tbody> <tr> <td>0</td> <td>Module found in slot 1</td> <td>1 = Yes: An FPTC-xx module has been detected in slot 1.</td> </tr> <tr> <td>1</td> <td>Fault active in slot 1</td> <td>1 = Yes: The module in slot 1 has an active fault (<a href="#">4991</a>).</td> </tr> <tr> <td>2</td> <td>Warning active in slot 1</td> <td>1 = Yes: The module in slot 1 has an active warning (<a href="#">A497</a>).</td> </tr> <tr> <td>3</td> <td>Module found in slot 2</td> <td>1 = Yes: An FPTC-xx module has been detected in slot 2.</td> </tr> <tr> <td>4</td> <td>Fault active in slot 2</td> <td>1 = Yes: The module in slot 2 has an active fault (<a href="#">4992</a>).</td> </tr> <tr> <td>5</td> <td>Warning active in slot 2</td> <td>1 = Yes: The module in slot 2 has an active warning (<a href="#">A498</a>).</td> </tr> <tr> <td>6</td> <td>Module found in slot 3</td> <td>1 = Yes: An FPTC-xx module has been detected in slot 3.</td> </tr> <tr> <td>7</td> <td>Fault active in slot 3</td> <td>1 = Yes: The module in slot 3 has an active fault (<a href="#">4993</a>).</td> </tr> <tr> <td>8</td> <td>Warning active in slot 3</td> <td>1 = Yes: The module in slot 3 has an active warning (<a href="#">A499</a>).</td> </tr> <tr> <td>9...15</td> <td>Reserved</td> <td></td> </tr> </tbody> </table> | Bit        | Name | Description | 0 | Module found in slot 1 | 1 = Yes: An FPTC-xx module has been detected in slot 1. | 1 | Fault active in slot 1 | 1 = Yes: The module in slot 1 has an active fault ( <a href="#">4991</a> ). | 2 | Warning active in slot 1 | 1 = Yes: The module in slot 1 has an active warning ( <a href="#">A497</a> ). | 3 | Module found in slot 2 | 1 = Yes: An FPTC-xx module has been detected in slot 2. | 4 | Fault active in slot 2 | 1 = Yes: The module in slot 2 has an active fault ( <a href="#">4992</a> ). | 5 | Warning active in slot 2 | 1 = Yes: The module in slot 2 has an active warning ( <a href="#">A498</a> ). | 6 | Module found in slot 3 | 1 = Yes: An FPTC-xx module has been detected in slot 3. | 7 | Fault active in slot 3 | 1 = Yes: The module in slot 3 has an active fault ( <a href="#">4993</a> ). | 8 | Warning active in slot 3 | 1 = Yes: The module in slot 3 has an active warning ( <a href="#">A499</a> ). | 9...15 | Reserved |  |  |
| Bit                                | Name   | Description  |            |      |             |   |                        |   |   |                        |   |   |                          |   |   |                        |   |   |                        |   |   |                          |   |   |                        |   |   |                        |   |   |                          |   |        |          |  |  |
| 0                                  | Module found in slot 1                           | 1 = Yes: An FPTC-xx module has been detected in slot 1.  |            |      |             |   |                        |   |   |                        |   |   |                          |   |   |                        |   |   |                        |   |   |                          |   |   |                        |   |   |                        |   |   |                          |   |        |          |  |  |
| 1                                  | Fault active in slot 1                           | 1 = Yes: The module in slot 1 has an active fault ( <a href="#">4991</a> ).  |            |      |             |   |                        |   |   |                        |   |   |                          |   |   |                        |   |   |                        |   |   |                          |   |   |                        |   |   |                        |   |   |                          |   |        |          |  |  |
| 2                                  | Warning active in slot 1                         | 1 = Yes: The module in slot 1 has an active warning ( <a href="#">A497</a> ).  |            |      |             |   |                        |   |   |                        |   |   |                          |   |   |                        |   |   |                        |   |   |                          |   |   |                        |   |   |                        |   |   |                          |   |        |          |  |  |
| 3                                  | Module found in slot 2                           | 1 = Yes: An FPTC-xx module has been detected in slot 2.  |            |      |             |   |                        |   |   |                        |   |   |                          |   |   |                        |   |   |                        |   |   |                          |   |   |                        |   |   |                        |   |   |                          |   |        |          |  |  |
| 4                                  | Fault active in slot 2                           | 1 = Yes: The module in slot 2 has an active fault ( <a href="#">4992</a> ).  |            |      |             |   |                        |   |   |                        |   |   |                          |   |   |                        |   |   |                        |   |   |                          |   |   |                        |   |   |                        |   |   |                          |   |        |          |  |  |
| 5                                  | Warning active in slot 2                         | 1 = Yes: The module in slot 2 has an active warning ( <a href="#">A498</a> ).  |            |      |             |   |                        |   |   |                        |   |   |                          |   |   |                        |   |   |                        |   |   |                          |   |   |                        |   |   |                        |   |   |                          |   |        |          |  |  |
| 6                                  | Module found in slot 3                           | 1 = Yes: An FPTC-xx module has been detected in slot 3.  |            |      |             |   |                        |   |   |                        |   |   |                          |   |   |                        |   |   |                        |   |   |                          |   |   |                        |   |   |                        |   |   |                          |   |        |          |  |  |
| 7                                  | Fault active in slot 3                           | 1 = Yes: The module in slot 3 has an active fault ( <a href="#">4993</a> ).  |            |      |             |   |                        |   |   |                        |   |   |                          |   |   |                        |   |   |                        |   |   |                          |   |   |                        |   |   |                        |   |   |                          |   |        |          |  |  |
| 8                                  | Warning active in slot 3                         | 1 = Yes: The module in slot 3 has an active warning ( <a href="#">A499</a> ).  |            |      |             |   |                        |   |   |                        |   |   |                          |   |   |                        |   |   |                        |   |   |                          |   |   |                        |   |   |                        |   |   |                          |   |        |          |  |  |
| 9...15                             | Reserved   |  |            |      |             |   |                        |   |   |                        |   |   |                          |   |   |                        |   |   |                        |   |   |                          |   |   |                        |   |   |                        |   |   |                          |   |        |          |  |  |
|                                    | 0000h...FFFFh                                    | FPTC-xx status word.   | 1 = 1      |      |             |   |                        |   |   |                        |   |   |                          |   |   |                        |   |   |                        |   |   |                          |   |   |                        |   |   |                        |   |   |                          |   |        |          |  |  |

| No.   | Name/Value                  | Description  | Def/FbEq16      |
|-------|-----------------------------|--|-----------------|
| 35.11 | <i>Temperature 1 source</i> | Selects the source from which measured temperature 1 is read.<br>For wiring examples, see the hardware manual of the drive. Usually this source is from a sensor connected to the motor controlled by the drive, but it could be used to measure and monitor a temperature from other parts of the process as long as a suitable sensor is used as per the selection list.   | <i>Disabled</i> |
|       | Disabled                    | None. Temperature monitoring function 1 is disabled.   | 0               |
|       | Estimated temperature       | Estimated motor temperature (see parameter <i>35.01 Motor estimated temperature</i> ).<br>The temperature is estimated from an internal drive calculation. It is important to set up the ambient temperature of the motor in <i>35.50 Motor ambient temperature</i> .  | 1               |
|       | KTY84 analog I/O            | KTY84 sensor connected to the analog input selected by parameter <i>35.14 Temperature 1 AI source</i> and an analog output. The input and output can be on the drive control unit or on an extension module.<br>The following settings are required: <ul style="list-style-type: none"> <li>• Set the hardware jumper or switch related to the analog input to <b>U</b> (voltage). Any change must be validated by a control unit reboot.</li> <li>• Set the unit selection parameter of the input to volt.</li> <li>• Set the source selection parameter of the analog output to "<i>Force KTY84 excitation</i>".</li> <li>• Select the analog input in parameter <i>35.14</i>. In case the input is located on an I/O extension module, use the selection <i>Other</i> to point at the actual input value parameter (for example, <i>14.26 AI1 actual value</i>).</li> </ul> The analog output feeds a constant current through the sensor. As the resistance of the sensor changes along with its temperature, the voltage over the sensor changes. The voltage is read by the analog input and converted into degrees. | 2               |
|       | KTY84 encoder module 1      | KTY84 sensor connected to encoder interface 1.<br>See also parameters <i>91.21 Module 1 temp sensor type</i> and <i>91.22 Module 1 temp filter time</i> .  | 3               |
|       | KTY84 encoder module 2      | KTY84 sensor connected to encoder interface 2.<br>See also parameters <i>91.24 Module 2 temp sensor type</i> and <i>91.25 Module 2 temp filter time</i> .  | 4               |
|       | 1 × Pt100 analog I/O        | Pt100 sensor connected to a standard analog input selected by parameter <i>35.14 Temperature 1 AI source</i> and an analog output. The input and output can be on the drive control unit or on an extension module.<br>The required settings are the same as with selection <i>KTY84 analog I/O</i> , except that the source selection parameter of the analog output must be set to <i>Force Pt100 excitation</i> .   | 5               |
|       | 2 × Pt100 analog I/O        | As selection <i>1 × Pt100 analog I/O</i> , but with two sensors connected in series. Using multiple sensors improves measurement accuracy significantly.   | 6               |
|       | 3 × Pt100 analog I/O        | As selection <i>1 × Pt100 analog I/O</i> , but with three sensors connected in series. Using multiple sensors improves measurement accuracy significantly.   | 7               |

| No.                   | Name/Value   | Description  | Def/FbEq16                       |
|-----------------------|--|--|----------------------------------|
|                       | PTC DI6  | PTC sensor connected to digital input DI6 (see the connection diagram on page 80).<br><b>Note:</b> Either 0 ohm (normal temperature) or 4000 ohm (excessive temperature) will be shown by <a href="#">35.02 Measured temperature 1</a> . By default, an excessive temperature will generate a warning as per parameter <a href="#">35.13 Temperature 1 warning limit</a> . If you want a fault instead, set <a href="#">35.12 Temperature 1 fault limit</a> to 4000 ohm. | 8                                |
|                       | PTC analog I/O   | PTC sensor connected to a standard analog input selected by parameter <a href="#">35.14 Temperature 1 AI source</a> and an analog output. The input and output can be on the drive control unit or on an extension module.<br>The required settings are the same as with selection <a href="#">KTY84 analog I/O</a> , except that the source selection parameter of the analog output must be set to <a href="#">Force PTC excitation</a> .                              | 20                               |
|                       | PTC encoder module 1                                   | PTC sensor connected to encoder interface 1.<br>See also parameters <a href="#">91.21 Module 1 temp sensor type</a> and <a href="#">91.22 Module 1 temp filter time</a> .  | 9                                |
|                       | PTC encoder module 2                                   | PTC sensor connected to encoder interface 2.<br>See also parameters <a href="#">91.24 Module 2 temp sensor type</a> and <a href="#">91.25 Module 2 temp filter time</a> .  | 10                               |
|                       | Direct temperature                                     | The temperature is taken from the source selected by parameter <a href="#">35.14 Temperature 1 AI source</a> . The value of the source is assumed to be in the unit of temperature specified by <a href="#">96.16 Unit selection</a> .   | 11                               |
|                       | 1 × Pt1000 analog I/O                                  | Pt1000 sensor connected to a standard analog input selected by parameter <a href="#">35.14 Temperature 1 AI source</a> and an analog output. The input and output can be on the drive control unit or on an extension module.<br>The required settings are the same as with selection <a href="#">KTY84 analog I/O</a> , except that the source selection parameter of the analog output must be set to <a href="#">Force Pt1000 excitation</a> .                        | 13                               |
|                       | 2 × Pt1000 analog I/O                                  | As selection <a href="#">1 × Pt1000 analog I/O</a> , but with two sensors connected in series. Using multiple sensors improves measurement accuracy significantly.   | 14                               |
|                       | 3 × Pt1000 analog I/O                                  | As selection <a href="#">1 × Pt1000 analog I/O</a> , but with three sensors connected in series. Using multiple sensors improves measurement accuracy significantly.   | 15                               |
| <a href="#">35.12</a> | <a href="#">Temperature 1 fault limit</a>              | Defines the fault limit for temperature monitoring function 1. When measured temperature 1 exceeds the limit, the drive trips on fault <a href="#">4981 External temperature 1</a> .<br>The unit is selected by parameter <a href="#">96.16 Unit selection</a> .<br><b>Note:</b> With a PTC sensor, the unit is ohms.  | 130 °C,<br>266 °F or<br>4500 ohm |
|                       | -60 ... 1000 °C,<br>-76 ... 1832 °F or<br>0...5000 ohm | Fault limit for temperature monitoring function 1.   | 1 = 1 unit                       |
| <a href="#">35.13</a> | <a href="#">Temperature 1 warning limit</a>            | Defines the warning limit for temperature monitoring function 1. When measured temperature 1 exceeds this limit, a warning ( <a href="#">A491 External temperature 1</a> ) is generated.<br>The unit is selected by parameter <a href="#">96.16 Unit selection</a> .<br><b>Note:</b> With a PTC sensor, the unit is ohms.  | 110 °C,<br>230 °F or<br>4000 ohm |
|                       | -60 ... 1000 °C,<br>-76 ... 1832 °F or<br>0...5000 ohm | Warning limit for temperature monitoring function 1.   | 1 = 1 unit                       |

| No.   | Name/Value                     | Description   | Def/FbEq16          |
|-------|--------------------------------|---|---------------------|
| 35.14 | <i>Temperature 1 AI source</i> | Specifies the analog input when the setting of 35.11 <i>Temperature 1 source</i> requires measurement through an analog input.<br><b>Note:</b> If the input is located on an I/O extension module, use the selection <i>Other</i> to point to the AI actual value in group 14, 15 or 16, eg. 14.26 <i>AI1 actual value</i> .  | <i>Not selected</i> |
|       | Not selected                   | None.   | 0                   |
|       | AI1 actual value               | Analog input AI1 on the control unit.   | 1                   |
|       | AI2 actual value               | Analog input AI2 on the control unit.   | 2                   |
|       | <i>Other</i>                   | Source selection (see <i>Terms and abbreviations</i> on page 112).  | -                   |
| 35.21 | <i>Temperature 2 source</i>    | Selects the source from which measured temperature 2 is read.<br>For wiring examples, see the hardware manual of the drive. Usually this source is from a sensor connected to the motor controlled by the drive, but it could be used to measure and monitor a temperature from other parts of the process as long as a suitable sensor is used as per the selection list.  | <i>Disabled</i>     |
|       | Disabled                       | None. Temperature monitoring function 2 is disabled.  | 0                   |
|       | Estimated temperature          | Estimated motor temperature (see parameter 35.01 <i>Motor estimated temperature</i> ).<br>The temperature is estimated from an internal drive calculation. It is important to set up the ambient temperature of the motor in 35.50 <i>Motor ambient temperature</i> .   | 1                   |
|       | KTY84 analog I/O               | KTY84 sensor connected to the analog input selected by parameter 35.24 <i>Temperature 2 AI source</i> and an analog output. The input and output can be on the drive control unit or on an extension module.<br>The following settings are required: <ul style="list-style-type: none"> <li>• Set the hardware jumper or switch related to the analog input to <b>U</b> (voltage). Any change must be validated by a control unit reboot.</li> <li>• Set the unit selection parameter of the input to volt.</li> <li>• Set the source selection parameter of the analog output to "<i>Force KTY84 excitation</i>".</li> <li>• Select the analog input in parameter 35.24. In case the input is located on an I/O extension module, use the selection <i>Other</i> to point at the actual input value parameter (for example, 14.26 <i>AI1 actual value</i>).</li> </ul> The analog output feeds a constant current through the sensor. As the resistance of the sensor changes along with its temperature, the voltage over the sensor changes. The voltage is read by the analog input and converted into degrees. | 2                   |
|       | KTY84 encoder module 1         | KTY84 sensor connected to encoder interface 1.<br>See also parameters 91.21 <i>Module 1 temp sensor type</i> and 91.22 <i>Module 1 temp filter time</i> .   | 3                   |
|       | KTY84 encoder module 2         | KTY84 sensor connected to encoder interface 2.<br>See also parameters 91.24 <i>Module 2 temp sensor type</i> and 91.25 <i>Module 2 temp filter time</i> .   | 4                   |



| No. | Name/Value            | Description   | Def/FbEq16 |
|-----|-----------------------|---|------------|
|     | 1 × Pt100 analog I/O  | Pt100 sensor connected to a standard analog input selected by parameter <a href="#">35.24 Temperature 2 AI source</a> and an analog output. The input and output can be on the drive control unit or on an extension module.<br>The required settings are the same as with selection <a href="#">KTY84 analog I/O</a> , except that the source selection parameter of the analog output must be set to <a href="#">Force Pt100 excitation</a> .   | 5          |
|     | 2 × Pt100 analog I/O  | As selection <a href="#">1 × Pt100 analog I/O</a> , but with two sensors connected in series. Using multiple sensors improves measurement accuracy significantly.   | 6          |
|     | 3 × Pt100 analog I/O  | As selection <a href="#">1 × Pt100 analog I/O</a> , but with three sensors connected in series. Using multiple sensors improves measurement accuracy significantly.   | 7          |
|     | PTC DI6               | PTC sensor connected to digital input DI6 (see the connection diagram on page <a href="#">80</a> ).<br><b>Note:</b> Either 0 ohm (normal temperature) or 4000 ohm (excessive temperature) will be shown by <a href="#">35.03 Measured temperature 2</a> . By default, an excessive temperature will generate a warning as per parameter <a href="#">35.23 Temperature 2 warning limit</a> . If you want a fault instead, set <a href="#">35.22 Temperature 2 fault limit</a> to 4000 ohm. | 8          |
|     | PTC analog I/O        | PTC sensor connected to a standard analog input selected by parameter <a href="#">35.24 Temperature 2 AI source</a> and an analog output. The input and output can be on the drive control unit or on an extension module.<br>The required settings are the same as with selection <a href="#">KTY84 analog I/O</a> , except that the source selection parameter of the analog output must be set to <a href="#">Force PTC excitation</a> .   | 20         |
|     | PTC encoder module 1  | PTC sensor connected to encoder interface 1.<br>See also parameters <a href="#">91.21 Module 1 temp sensor type</a> and <a href="#">91.22 Module 1 temp filter time</a> .   | 9          |
|     | PTC encoder module 2  | PTC sensor connected to encoder interface 2.<br>See also parameters <a href="#">91.24 Module 2 temp sensor type</a> and <a href="#">91.25 Module 2 temp filter time</a> .   | 10         |
|     | Direct temperature    | The temperature is taken from the source selected by parameter <a href="#">35.24 Temperature 2 AI source</a> . The value of the source is assumed to be in the unit of temperature specified by <a href="#">96.16 Unit selection</a> .  | 11         |
|     | 1 × Pt1000 analog I/O | Pt1000 sensor connected to a standard analog input selected by parameter <a href="#">35.24 Temperature 2 AI source</a> and an analog output. The input and output can be on the drive control unit or on an extension module.<br>The required settings are the same as with selection <a href="#">KTY84 analog I/O</a> , except that the source selection parameter of the analog output must be set to <a href="#">Force Pt1000 excitation</a> .   | 13         |
|     | 2 × Pt1000 analog I/O | As selection <a href="#">1 × Pt1000 analog I/O</a> , but with two sensors connected in series. Using multiple sensors improves measurement accuracy significantly.  | 14         |
|     | 3 × Pt1000 analog I/O | As selection <a href="#">1 × Pt1000 analog I/O</a> , but with three sensors connected in series. Using multiple sensors improves measurement accuracy significantly.  | 15         |

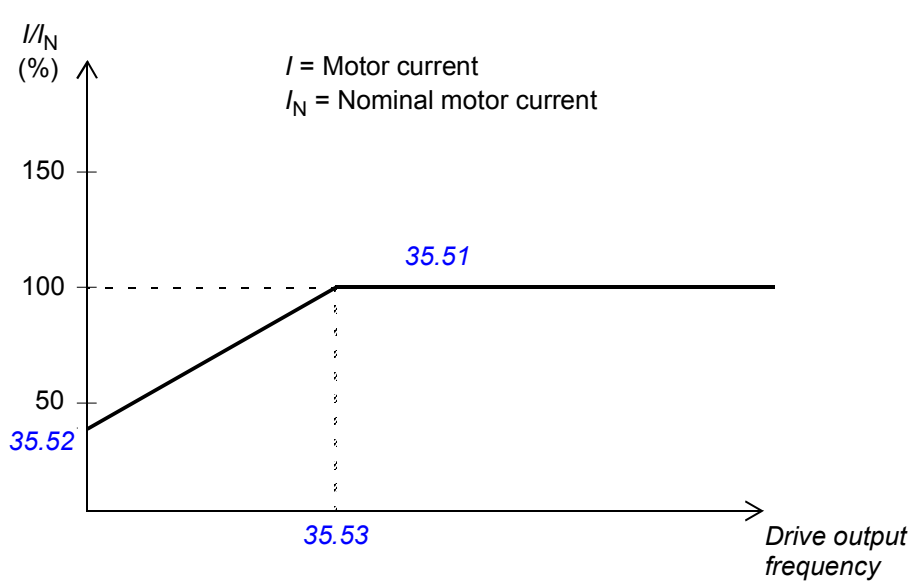

| No.    | Name/Value   | Description  | Def/FbEq16                       |      |             |   |                  |                                      |   |                        |   |   |                  |                                      |   |                        |   |   |                  |                                      |   |                        |   |        |          |  |  |
|--------|--|--|----------------------------------|------|-------------|---|------------------|--------------------------------------|---|------------------------|---|---|------------------|--------------------------------------|---|------------------------|---|---|------------------|--------------------------------------|---|------------------------|---|--------|----------|--|--|
| 35.22  | <i>Temperature 2 fault limit</i>                       | Defines the fault limit for temperature monitoring function 2. When measured temperature 2 exceeds the limit, the drive trips on fault <a href="#">4982 External temperature 2</a> . The unit is selected by parameter <a href="#">96.16 Unit selection</a> .<br><b>Note:</b> With a PTC sensor, the unit is ohms.   | 130 °C,<br>266 °F or<br>4500 ohm |      |             |   |                  |                                      |   |                        |   |   |                  |                                      |   |                        |   |   |                  |                                      |   |                        |   |        |          |  |  |
|        | -60 ... 1000 °C,<br>-76 ... 1832 °F or<br>0...5000 ohm | Fault limit for temperature monitoring function 2.   | 1 = 1 unit                       |      |             |   |                  |                                      |   |                        |   |   |                  |                                      |   |                        |   |   |                  |                                      |   |                        |   |        |          |  |  |
| 35.23  | <i>Temperature 2 warning limit</i>                     | Defines the warning limit for temperature monitoring function 2. When measured temperature 2 exceeds the limit, a warning ( <a href="#">A492 External temperature 2</a> ) is generated. The unit is selected by parameter <a href="#">96.16 Unit selection</a> .<br><b>Note:</b> With a PTC sensor, the unit is ohms.  | 110 °C,<br>230 °F or<br>4000 ohm |      |             |   |                  |                                      |   |                        |   |   |                  |                                      |   |                        |   |   |                  |                                      |   |                        |   |        |          |  |  |
|        | -60 ... 1000 °C,<br>-76 ... 1832 °F or<br>0...5000 ohm | Warning limit for temperature monitoring function 2.   | 1 = 1 unit                       |      |             |   |                  |                                      |   |                        |   |   |                  |                                      |   |                        |   |   |                  |                                      |   |                        |   |        |          |  |  |
| 35.24  | <i>Temperature 2 AI source</i>                         | Selects the input for parameter <a href="#">35.21 Temperature 2 source</a> , selections <a href="#">KTY84 analog I/O</a> , <a href="#">1 × Pt100 analog I/O</a> , <a href="#">2 × Pt100 analog I/O</a> , <a href="#">3 × Pt100 analog I/O</a> and <a href="#">Direct temperature</a> .   | <i>Not selected</i>              |      |             |   |                  |                                      |   |                        |   |   |                  |                                      |   |                        |   |   |                  |                                      |   |                        |   |        |          |  |  |
|        | Not selected   | None.  | 0                                |      |             |   |                  |                                      |   |                        |   |   |                  |                                      |   |                        |   |   |                  |                                      |   |                        |   |        |          |  |  |
|        | AI1 actual value                                       | Analog input AI1 on the control unit.  | 1                                |      |             |   |                  |                                      |   |                        |   |   |                  |                                      |   |                        |   |   |                  |                                      |   |                        |   |        |          |  |  |
|        | AI2 actual value                                       | Analog input AI2 on the control unit.  | 2                                |      |             |   |                  |                                      |   |                        |   |   |                  |                                      |   |                        |   |   |                  |                                      |   |                        |   |        |          |  |  |
|        | <i>Other</i>   | Source selection (see <a href="#">Terms and abbreviations</a> on page 112).  | -                                |      |             |   |                  |                                      |   |                        |   |   |                  |                                      |   |                        |   |   |                  |                                      |   |                        |   |        |          |  |  |
| 35.30  | <i>FPTC configuration word</i>                         | Activates FPTC-xx thermistor protection modules installed on the control unit of the drive. Using this word, it is also possible to suppress the warnings (but not faults) from each module.   | 0010 1010b                       |      |             |   |                  |                                      |   |                        |   |   |                  |                                      |   |                        |   |   |                  |                                      |   |                        |   |        |          |  |  |
|        |  | <table border="1"> <thead> <tr> <th>Bit</th> <th>Name</th> <th>Description</th> </tr> </thead> <tbody> <tr> <td>0</td> <td>Module in slot 1</td> <td>1 = Yes: Module installed in slot 1.</td> </tr> <tr> <td>1</td> <td>Disable slot 1 warning</td> <td>1 = Yes: Warnings from the module in slot 1 suppressed.</td> </tr> <tr> <td>2</td> <td>Module in slot 2</td> <td>1 = Yes: Module installed in slot 2.</td> </tr> <tr> <td>3</td> <td>Disable slot 2 warning</td> <td>1 = Yes: Warnings from the module in slot 2 suppressed.</td> </tr> <tr> <td>4</td> <td>Module in slot 3</td> <td>1 = Yes: Module installed in slot 3.</td> </tr> <tr> <td>5</td> <td>Disable slot 3 warning</td> <td>1 = Yes: Warnings from the module in slot 3 suppressed.</td> </tr> <tr> <td>6...15</td> <td>Reserved</td> <td></td> </tr> </tbody> </table> | Bit                              | Name | Description | 0 | Module in slot 1 | 1 = Yes: Module installed in slot 1. | 1 | Disable slot 1 warning | 1 = Yes: Warnings from the module in slot 1 suppressed. | 2 | Module in slot 2 | 1 = Yes: Module installed in slot 2. | 3 | Disable slot 2 warning | 1 = Yes: Warnings from the module in slot 2 suppressed. | 4 | Module in slot 3 | 1 = Yes: Module installed in slot 3. | 5 | Disable slot 3 warning | 1 = Yes: Warnings from the module in slot 3 suppressed. | 6...15 | Reserved |  |  |
| Bit    | Name   | Description  |                                  |      |             |   |                  |                                      |   |                        |   |   |                  |                                      |   |                        |   |   |                  |                                      |   |                        |   |        |          |  |  |
| 0      | Module in slot 1                                       | 1 = Yes: Module installed in slot 1.   |                                  |      |             |   |                  |                                      |   |                        |   |   |                  |                                      |   |                        |   |   |                  |                                      |   |                        |   |        |          |  |  |
| 1      | Disable slot 1 warning                                 | 1 = Yes: Warnings from the module in slot 1 suppressed.  |                                  |      |             |   |                  |                                      |   |                        |   |   |                  |                                      |   |                        |   |   |                  |                                      |   |                        |   |        |          |  |  |
| 2      | Module in slot 2                                       | 1 = Yes: Module installed in slot 2.   |                                  |      |             |   |                  |                                      |   |                        |   |   |                  |                                      |   |                        |   |   |                  |                                      |   |                        |   |        |          |  |  |
| 3      | Disable slot 2 warning                                 | 1 = Yes: Warnings from the module in slot 2 suppressed.  |                                  |      |             |   |                  |                                      |   |                        |   |   |                  |                                      |   |                        |   |   |                  |                                      |   |                        |   |        |          |  |  |
| 4      | Module in slot 3                                       | 1 = Yes: Module installed in slot 3.   |                                  |      |             |   |                  |                                      |   |                        |   |   |                  |                                      |   |                        |   |   |                  |                                      |   |                        |   |        |          |  |  |
| 5      | Disable slot 3 warning                                 | 1 = Yes: Warnings from the module in slot 3 suppressed.  |                                  |      |             |   |                  |                                      |   |                        |   |   |                  |                                      |   |                        |   |   |                  |                                      |   |                        |   |        |          |  |  |
| 6...15 | Reserved   |  |                                  |      |             |   |                  |                                      |   |                        |   |   |                  |                                      |   |                        |   |   |                  |                                      |   |                        |   |        |          |  |  |
|        | 0000 0000b ...<br>0011 1111b                           | FPTC-xx module configuration word.   | 1 = 1                            |      |             |   |                  |                                      |   |                        |   |   |                  |                                      |   |                        |   |   |                  |                                      |   |                        |   |        |          |  |  |
| 35.50  | <i>Motor ambient temperature</i>                       | Defines the ambient temperature of the motor for the motor thermal protection model. The unit is selected by parameter <a href="#">96.16 Unit selection</a> .<br>The motor thermal protection model estimates the motor temperature on the basis of parameters <a href="#">35.50...35.55</a> . The motor temperature increases if it operates in the region above the load curve, and decreases if it operates in the region below the load curve.<br> <b>WARNING!</b> The model cannot protect the motor if the motor does not cool properly because of dust, dirt, etc.   | 20 °C or<br>68 °F                |      |             |   |                  |                                      |   |                        |   |   |                  |                                      |   |                        |   |   |                  |                                      |   |                        |   |        |          |  |  |
|        | -60 ... 100 °C or<br>-75 ... 212 °F                    | Ambient temperature.   | 1 = 1°                           |      |             |   |                  |                                      |   |                        |   |   |                  |                                      |   |                        |   |   |                  |                                      |   |                        |   |        |          |  |  |

| No.   | Name/Value              | Description   | Def/FbEq16                     |
|-------|-------------------------|---|--------------------------------|
| 35.51 | <i>Motor load curve</i> | <p>Defines the motor load curve together with parameters <a href="#">35.52 Zero speed load</a> and <a href="#">35.53 Break point</a>. The load curve is used by the motor thermal protection model to estimate the motor temperature.</p> <p>When the parameter is set to 100%, the maximum load is taken as the value of parameter <a href="#">99.06 Motor nominal current</a> (higher loads heat up the motor). The load curve level should be adjusted if the ambient temperature differs from the nominal value set in <a href="#">35.50 Motor ambient temperature</a>.</p>  | 100%                           |
|       | 50 ... 150%             | Maximum load for the motor load curve.  | 1 = 1%                         |
| 35.52 | <i>Zero speed load</i>  | <p>Defines the motor load curve together with parameters <a href="#">35.51 Motor load curve</a> and <a href="#">35.53 Break point</a>. Defines the maximum motor load at zero speed of the load curve. A higher value can be used if the motor has an external motor fan to boost the cooling. See the motor manufacturer's recommendations.</p> <p>See parameter <a href="#">35.51 Motor load curve</a>.</p>   | 100%                           |
|       | 50 ... 150%             | Zero speed load for the motor load curve.   | 1 = 1%                         |
| 35.53 | <i>Break point</i>      | <p>Defines the motor load curve together with parameters <a href="#">35.51 Motor load curve</a> and <a href="#">35.52 Zero speed load</a>. Defines the break point frequency of the load curve i.e. the point at which the motor load curve begins to decrease from the value of parameter <a href="#">35.51 Motor load curve</a> towards the value of parameter <a href="#">35.52 Zero speed load</a>.</p> <p>See parameter <a href="#">35.51 Motor load curve</a>.</p>  | 45.00 Hz                       |
|       | 1.00 ... 500.00 Hz      | Break point for the motor load curve.   | See par. <a href="#">46.02</a> |

| No.   | Name/Value                            | Description  | Def/FbEq16      |
|-------|---------------------------------------|--|-----------------|
| 35.54 | <i>Motor nominal temperature rise</i> | Defines the temperature rise of the motor above ambient when the motor is loaded with nominal current. See the motor manufacturer's recommendations.<br>The unit is selected by parameter <a href="#">96.16 Unit selection</a> . | 80 °C or 176 °F |
|       |                                       |  |                 |
|       | 0...300 °C or 32...572 °F             | Temperature rise.  | 1 = 1°          |
| 35.55 | <i>Motor thermal time constant</i>    | Defines the thermal time constant for use with the motor thermal protection model, defined as the time to reach 63% of the nominal motor temperature. See the motor manufacturer's recommendations.                              | 256 s           |
|       |                                       |  |                 |
|       | 100 ... 10000 s                       | Motor thermal time constant.   | 1 = 1 s         |

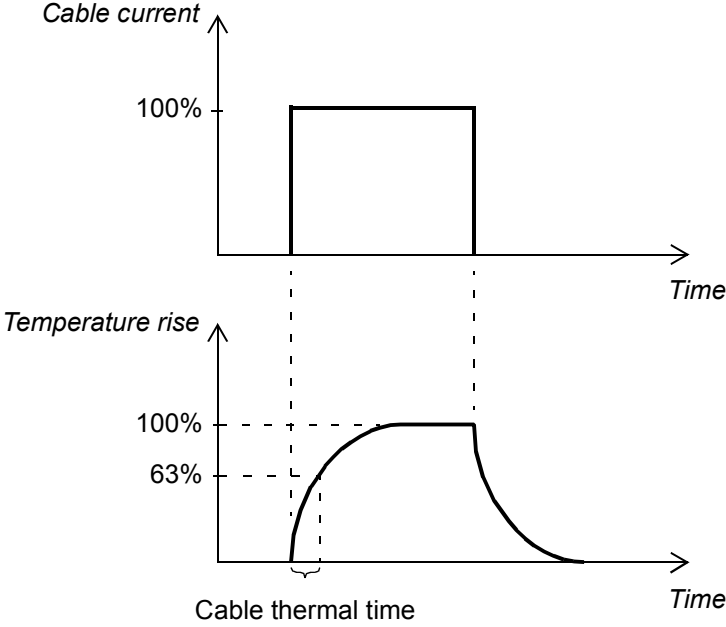
| No.  | Name/Value                     | Description   | Def/FbEq16 |
|--|--------------------------------|---|------------|
| 35.60  | <i>Cable temperature</i>       | Shows the calculated temperature of the motor cable. See section <i>Thermal protection of motor cable</i> (page 83).<br>102% = overtemperature warning ( <i>A480 Motor cable overload</i> )<br>106% = overtemperature fault ( <i>4000 Motor cable overload</i> )<br>This parameter is read-only.  | 0.0%       |
|  | 0.0 ... 200.0%                 | Calculated temperature of motor cable.  | 1 = 1%     |
| 35.61  | <i>Cable nominal current</i>   | Specifies the continuous current of the motor cable for the thermal protection function in the control program.<br> <b>WARNING!</b> The value entered in this parameter must be limited according to all factors affecting the loadability of the cable, such as ambient temperature, cabling arrangement, and shrouding. Refer to the technical data from the cable manufacturer. | 10000.00 A |
|  | 0.00 ... 10000.00 A            | Continuous current-carrying capacity of motor cable.  | 1 = 1 A    |
| 35.62  | <i>Cable thermal rise time</i> | Specifies the thermal time of the motor cable for the thermal protection function in the control program. This value is defined as the time to reach 63% of the nominal cable temperature when the cable is loaded with nominal current (parameter 35.61 <i>Cable nominal current</i> ).<br>0 s = Thermal protection of motor cable disabled<br>Refer to the technical data from the cable manufacturer.  | 1 s        |
|  |                                |   |            |
|  | 0 s                            | Thermal protection of motor cable disabled.   | 1 = 1 s    |
|  | 1...50000 s                    | Motor cable thermal time constant.  | 1 = 1 s    |

| No.                    | Name/Value                                  | Description  | Def/FbEq16   |
|------------------------|---|--|--|
| <a href="#">35.100</a> | <a href="#">DOL starter control source</a>  | Parameters <a href="#">35.100</a> ... <a href="#">35.106</a> configure a monitored start/stop control logic for external equipment such as a contactor-controlled motor cooling fan.<br>This parameter selects the signal that starts and stops the fan.<br>0 = Stop<br>1 = Start<br>The output controlling the fan contactor is to be connected to parameter <a href="#">35.105</a> , bit 1. On and off delays can be set for the fan by <a href="#">35.101</a> and <a href="#">35.102</a> respectively. A feedback signal from the fan can be connected to an input selected by <a href="#">35.103</a> ; the loss of the feedback will optionally trigger a warning or fault (see <a href="#">35.104</a> and <a href="#">35.106</a> ). | <a href="#">Off</a> , <a href="#">06.16</a> b6 ( <a href="#">95.20</a> b6)     |
|                        | Off   | 0 (function disabled).   | 0  |
|                        | On  | 1.   | 1  |
|                        | Running                                     | Bit 6 of <a href="#">06.16 Drive status word 1</a> (see page <a href="#">130</a> ).  | 2  |
|                        | <a href="#">Other [bit]</a>                 | Source selection (see <a href="#">Terms and abbreviations</a> on page <a href="#">112</a> ).   | -  |
| <a href="#">35.101</a> | <a href="#">DOL starter on delay</a>        | Defines a start delay for the motor fan.<br>The delay timer starts when the control source selected by parameter <a href="#">35.100</a> switches on. After the delay, bit 1 of <a href="#">35.105</a> switches on.   | 0 s  |
|                        | 0...42949673 s                              | Motor fan start delay.   | 1 = 1 s  |
| <a href="#">35.102</a> | <a href="#">DOL starter off delay</a>       | Defines a stop delay for the motor fan.<br>The delay timer starts when the control source selected by parameter <a href="#">35.100</a> switches off. After the delay, bit 1 of <a href="#">35.105</a> switches off.  | 20 min   |
|                        | 0...715828 min                              | Motor fan stop delay.  | 1 = 1 min  |
| <a href="#">35.103</a> | <a href="#">DOL starter feedback source</a> | Selects the input for motor fan feedback signal.<br>0 = Stopped<br>1 = Running<br>After the fan is started (bit 1 of <a href="#">35.105</a> switches on), feedback is expected within the time set by <a href="#">35.104</a> .   | <a href="#">Not selected</a> ; <a href="#">DI5</a> ( <a href="#">95.20</a> b6) |
|                        | Not selected                                | 0.   | 0  |
|                        | Selected                                    | 1.   | 1  |
|                        | DI1   | Digital input DI1 ( <a href="#">10.02 DI delayed status</a> , bit 0).  | 2  |
|                        | DI2   | Digital input DI2 ( <a href="#">10.02 DI delayed status</a> , bit 1).  | 3  |
|                        | DI3   | Digital input DI3 ( <a href="#">10.02 DI delayed status</a> , bit 2).  | 4  |
|                        | DI4   | Digital input DI4 ( <a href="#">10.02 DI delayed status</a> , bit 3).  | 5  |
|                        | DI5   | Digital input DI5 ( <a href="#">10.02 DI delayed status</a> , bit 4).  | 6  |
|                        | DI6   | Digital input DI6 ( <a href="#">10.02 DI delayed status</a> , bit 5).  | 7  |
|                        | DIO1  | Digital input/output DIO1 ( <a href="#">11.02 DIO delayed status</a> , bit 0).   | 10   |
|                        | DIO2  | Digital input/output DIO2 ( <a href="#">11.02 DIO delayed status</a> , bit 1).   | 11   |
|                        | <a href="#">Other [bit]</a>                 | Source selection (see <a href="#">Terms and abbreviations</a> on page <a href="#">112</a> ).   | -  |

| No.  | Name/Value                        | Description  | Def/FbEq16             |     |      |             |   |               |   |   |                       |   |   |              |   |   |                |  |        |          |  |
|--|-----------------------------------|--|------------------------|-----|------|-------------|---|---------------|---|---|-----------------------|---|---|--------------|---|---|----------------|--|--------|----------|--|
| 35.104   | <i>DOL starter feedback delay</i> | Defines a feedback delay for the motor fan.<br>The delay timer starts when bit 1 of 35.105 switches on. If no feedback is received from the fan until the delay elapses, the action selected by 35.106 is taken.<br><b>Note:</b> This delay is only applied at start. If the feedback signal is lost during run, the action selected by 35.106 is taken immediately.   | 0 s; 5 s<br>(95.20 b6) |     |      |             |   |               |   |   |                       |   |   |              |   |   |                |  |        |          |  |
|  | 0...42949673 s                    | Motor fan start delay.   | 1 = 1 s                |     |      |             |   |               |   |   |                       |   |   |              |   |   |                |  |        |          |  |
| 35.105   | <i>DOL starter status word</i>    | Status of the motor fan control logic.<br>Bit 1 is the control output for the fan, to be selected as the source of, for example, a digital or relay output.<br>The other bits indicate the statuses of the selected control and feedback sources, and the fault status.<br>This parameter is read-only.  | -                      |     |      |             |   |               |   |   |                       |   |   |              |   |   |                |  |        |          |  |
| <table border="1"> <thead> <tr> <th>Bit</th> <th>Name</th> <th>Description</th> </tr> </thead> <tbody> <tr> <td>0</td> <td>Start command</td> <td>Status of fan control source selected by 35.100.<br/>0 = Stop requested<br/>1 = Start requested</td> </tr> <tr> <td>1</td> <td>Delayed start command</td> <td>Fan control bit (delays observed). Select this bit as the source of the output controlling the fan.<br/>0 = Stopped<br/>1 = Started</td> </tr> <tr> <td>2</td> <td>DOL feedback</td> <td>Status of fan feedback (source selected by 35.103).<br/>0 = Stopped<br/>1 = Running</td> </tr> <tr> <td>3</td> <td>DOL fault (-1)</td> <td>Fault status.<br/>0 = Fault (fan feedback missing). The action taken is selected by 35.106.<br/>1 = No fault</td> </tr> <tr> <td>4...15</td> <td>Reserved</td> <td></td> </tr> </tbody> </table> |                                   |  |                        | Bit | Name | Description | 0 | Start command | Status of fan control source selected by 35.100.<br>0 = Stop requested<br>1 = Start requested | 1 | Delayed start command | Fan control bit (delays observed). Select this bit as the source of the output controlling the fan.<br>0 = Stopped<br>1 = Started | 2 | DOL feedback | Status of fan feedback (source selected by 35.103).<br>0 = Stopped<br>1 = Running | 3 | DOL fault (-1) | Fault status.<br>0 = Fault (fan feedback missing). The action taken is selected by 35.106.<br>1 = No fault | 4...15 | Reserved |  |
| Bit  | Name                              | Description  |                        |     |      |             |   |               |   |   |                       |   |   |              |   |   |                |  |        |          |  |
| 0  | Start command                     | Status of fan control source selected by 35.100.<br>0 = Stop requested<br>1 = Start requested  |                        |     |      |             |   |               |   |   |                       |   |   |              |   |   |                |  |        |          |  |
| 1  | Delayed start command             | Fan control bit (delays observed). Select this bit as the source of the output controlling the fan.<br>0 = Stopped<br>1 = Started  |                        |     |      |             |   |               |   |   |                       |   |   |              |   |   |                |  |        |          |  |
| 2  | DOL feedback                      | Status of fan feedback (source selected by 35.103).<br>0 = Stopped<br>1 = Running  |                        |     |      |             |   |               |   |   |                       |   |   |              |   |   |                |  |        |          |  |
| 3  | DOL fault (-1)                    | Fault status.<br>0 = Fault (fan feedback missing). The action taken is selected by 35.106.<br>1 = No fault   |                        |     |      |             |   |               |   |   |                       |   |   |              |   |   |                |  |        |          |  |
| 4...15   | Reserved                          |  |                        |     |      |             |   |               |   |   |                       |   |   |              |   |   |                |  |        |          |  |
|  | 0000b...1111b                     | Status of motor fan control logic.   | 1 = 1                  |     |      |             |   |               |   |   |                       |   |   |              |   |   |                |  |        |          |  |
| 35.106   | <i>DOL starter event type</i>     | Selects the action taken when missing fan feedback is detected by the motor fan control logic.   | <i>Fault</i>           |     |      |             |   |               |   |   |                       |   |   |              |   |   |                |  |        |          |  |
|  | No action                         | No action taken.   | 0                      |     |      |             |   |               |   |   |                       |   |   |              |   |   |                |  |        |          |  |
|  | Warning                           | The drive generates a warning ( <i>A781 Motor fan</i> ).   | 1                      |     |      |             |   |               |   |   |                       |   |   |              |   |   |                |  |        |          |  |
|  | Fault                             | Drive trips on <i>71B1 Motor fan</i> .   | 2                      |     |      |             |   |               |   |   |                       |   |   |              |   |   |                |  |        |          |  |
| <b>36 Load analyzer</b>  |                                   | Peak value and amplitude logger settings.<br>See also section <i>Load analyzer</i> (page 88).  |                        |     |      |             |   |               |   |   |                       |   |   |              |   |   |                |  |        |          |  |
| 36.01  | <i>PVL signal source</i>          | Selects the signal to be monitored by the peak value logger.<br>The signal is filtered using the filtering time specified by parameter 36.02 <i>PVL filter time</i> .<br>The peak value is stored, along with other pre-selected signals at the time, into parameters 36.10...36.15.<br>The peak value logger can be reset using parameter 36.09 <i>Reset loggers</i> . The logger is also reset whenever the signal source is changed. The date and time of the last reset are stored into parameters 36.16 and 36.17 respectively. | <i>Power in/out</i>    |     |      |             |   |               |   |   |                       |   |   |              |   |   |                |  |        |          |  |
|  | Zero                              | None (peak value logger disabled).   | 0                      |     |      |             |   |               |   |   |                       |   |   |              |   |   |                |  |        |          |  |
|  | Motor speed used                  | <i>01.01 Motor speed used</i> (page 115).  | 1                      |     |      |             |   |               |   |   |                       |   |   |              |   |   |                |  |        |          |  |

| No.          | Name/Value                      | Description   | Def/FbEq16                 |
|--------------|---------------------------------|---|----------------------------|
|              | Output frequency                | <a href="#">01.06 Output frequency</a> (page 115).  | 3                          |
|              | Motor current                   | <a href="#">01.07 Motor current</a> (page 115).   | 4                          |
|              | Motor torque                    | <a href="#">01.10 Motor torque</a> (page 115).  | 6                          |
|              | DC voltage                      | <a href="#">01.11 DC voltage</a> (page 115).  | 7                          |
|              | Power inu out                   | <a href="#">01.14 Output power</a> (page 116).  | 8                          |
|              | Speed ref ramp in               | <a href="#">23.01 Speed ref ramp input</a> (page 218).  | 10                         |
|              | Speed ref ramped                | <a href="#">23.02 Speed ref ramp output</a> (page 218).   | 11                         |
|              | Speed ref used                  | <a href="#">24.01 Used speed reference</a> (page 224).  | 12                         |
|              | Torq ref used                   | <a href="#">26.02 Torque reference used</a> (page 240).   | 13                         |
|              | Freq ref used                   | <a href="#">28.02 Frequency ref ramp output</a> (page 246).   | 14                         |
|              | Process PID out                 | <a href="#">40.01 Process PID output actual</a> (page 301).   | 16                         |
|              | Process PID fbk                 | <a href="#">40.02 Process PID feedback actual</a> (page 301).   | 17                         |
|              | Process PID act                 | <a href="#">40.03 Process PID setpoint actual</a> (page 301).   | 18                         |
|              | Process PID dev                 | <a href="#">40.04 Process PID deviation actual</a> (page 301).  | 19                         |
|              | <i>Other</i>                    | Source selection (see <a href="#">Terms and abbreviations</a> on page 112).   | -                          |
| <b>36.02</b> | <b><i>PVL filter time</i></b>   | Defines a filtering time for the peak value logger. See parameter <a href="#">36.01 PVL signal source</a> .   | 2.00 s                     |
|              | 0.00 ... 120.00 s               | Peak value logger filtering time.   | 100 = 1 s                  |
| <b>36.06</b> | <b><i>AL2 signal source</i></b> | Selects the signal to be monitored by amplitude logger 2. The signal is sampled at 200 ms intervals, and can be scaled using parameter <a href="#">36.07 AL2 signal scaling</a> .<br>The results are displayed by parameters <a href="#">36.40...36.49</a> . Each parameter represents an amplitude range, and shows what portion of the samples fall within that range.<br>Amplitude logger 2 can be reset using parameter <a href="#">36.09 Reset loggers</a> . The logger is also reset whenever the signal source or scaling is changed. The date and time of the last reset are stored into parameters <a href="#">36.50</a> and <a href="#">36.51</a> respectively. | <i>Ambient temperature</i> |
|              | Zero                            | None (amplitude logger 2 disabled).   | 0                          |
|              | Motor speed used                | <a href="#">01.01 Motor speed used</a> (page 115).  | 1                          |
|              | Output frequency                | <a href="#">01.06 Output frequency</a> (page 115).  | 3                          |
|              | Motor current                   | <a href="#">01.07 Motor current</a> (page 115).   | 4                          |
|              | Motor torque                    | <a href="#">01.10 Motor torque</a> (page 115).  | 6                          |
|              | DC voltage                      | <a href="#">01.11 DC voltage</a> (page 115).  | 7                          |
|              | Power inu out                   | <a href="#">01.14 Output power</a> (page 116).  | 8                          |
|              | Speed ref ramp in               | <a href="#">23.01 Speed ref ramp input</a> (page 218).  | 10                         |
|              | Speed ref ramped                | <a href="#">23.02 Speed ref ramp output</a> (page 218).   | 11                         |
|              | Speed ref used                  | <a href="#">24.01 Used speed reference</a> (page 224).  | 12                         |
|              | Torq ref used                   | <a href="#">26.02 Torque reference used</a> (page 240).   | 13                         |
|              | Freq ref used                   | <a href="#">28.02 Frequency ref ramp output</a> (page 246).   | 14                         |
|              | Process PID out                 | <a href="#">40.01 Process PID output actual</a> (page 301).   | 16                         |
|              | Process PID fbk                 | <a href="#">40.02 Process PID feedback actual</a> (page 301).   | 17                         |
|              | Process PID act                 | <a href="#">40.03 Process PID setpoint actual</a> (page 301).   | 18                         |
|              | Process PID dev                 | <a href="#">40.04 Process PID deviation actual</a> (page 301).  | 19                         |

| No.                   | Name/Value                             | Description   | Def/FbEq16                     |
|-----------------------|--|---|--------------------------------|
|                       | Ambient temperature                    | <a href="#">01.70 Ambient temperature %</a> (page 118).<br>The amplitude range of 0...100% corresponds to 0...60 °C or 32...140 °F.                                   | 20                             |
|                       | <i>Other</i>                           | Source selection (see <a href="#">Terms and abbreviations</a> on page 112).   | -                              |
| <a href="#">36.07</a> | <a href="#">AL2 signal scaling</a>     | Defines the signal value that corresponds to 100% amplitude.  | 100.00                         |
|                       | 0.00 ... 32767.00                      | Signal value corresponding to 100%.   | 1 = 1                          |
| <a href="#">36.09</a> | <a href="#">Reset loggers</a>          | Resets the peak value logger and/or amplitude logger 2. (Amplitude logger 1 cannot be reset.)   | <a href="#">Done</a>           |
|                       | Done                                   | Reset completed or not requested (normal operation).  | 0                              |
|                       | All                                    | Reset both the peak value logger and amplitude logger 2.  | 1                              |
|                       | PVL                                    | Reset the peak value logger.  | 2                              |
|                       | AL2                                    | Reset amplitude logger 2.   | 3                              |
| <a href="#">36.10</a> | <a href="#">PVL peak value</a>         | Displays the peak value recorded by the peak value logger.  | 0.00                           |
|                       | -32768.00 ...<br>32767.00              | Peak value.   | 1 = 1                          |
| <a href="#">36.11</a> | <a href="#">PVL peak date</a>          | Displays the date on which the peak value was recorded.   | -                              |
|                       | -                                      | Peak occurrence date.   | -                              |
| <a href="#">36.12</a> | <a href="#">PVL peak time</a>          | Displays the time at which the peak value was recorded.   | -                              |
|                       | -                                      | Peak occurrence time.   | -                              |
| <a href="#">36.13</a> | <a href="#">PVL current at peak</a>    | Displays the motor current at the moment the peak value was recorded.   | 0.00 A                         |
|                       | -32768.00 ...<br>32767.00 A            | Motor current at peak.  | 1 = 1 A                        |
| <a href="#">36.14</a> | <a href="#">PVL DC voltage at peak</a> | Displays the voltage in the intermediate DC circuit of the drive at the moment the peak value was recorded.   | 0.00 V                         |
|                       | 0.00 ... 2000.00 V                     | DC voltage at peak.   | 10 = 1 V                       |
| <a href="#">36.15</a> | <a href="#">PVL speed at peak</a>      | Displays the motor speed at the moment the peak value was recorded.   | 0.00 rpm                       |
|                       | -32768.00 ...<br>32767.00 rpm          | Motor speed at peak.  | See par. <a href="#">46.01</a> |
| <a href="#">36.16</a> | <a href="#">PVL reset date</a>         | Displays the date on which the peak value logger was last reset.  | -                              |
|                       | -                                      | Last reset date of the peak value logger.   | -                              |
| <a href="#">36.17</a> | <a href="#">PVL reset time</a>         | Displays the time at which the peak value logger was last reset.  | -                              |
|                       | -                                      | Last reset time of the peak value logger.   | -                              |
| <a href="#">36.20</a> | <a href="#">AL1 below 10%</a>          | Displays the percentage of samples recorded by amplitude logger 1 that were below 10%. Note that this percentage also includes the samples that had a negative value. | 0.00%                          |
|                       | 0.00 ... 100.00%                       | Amplitude logger 1 samples below 10%.   | 1 = 1%                         |
| <a href="#">36.21</a> | <a href="#">AL1 10 to 20%</a>          | Displays the percentage of samples recorded by amplitude logger 1 that fall between 10 and 20%.   | 0.00%                          |
|                       | 0.00 ... 100.00%                       | Amplitude logger 1 samples between 10 and 20%.  | 1 = 1%                         |
| <a href="#">36.22</a> | <a href="#">AL1 20 to 30%</a>          | Displays the percentage of samples recorded by amplitude logger 1 that fall between 20 and 30%.   | 0.00%                          |
|                       | 0.00 ... 100.00%                       | Amplitude logger 1 samples between 20 and 30%.  | 1 = 1%                         |



| No.   | Name/Value           | Description   | Def/FbEq16 |
|-------|----------------------|---|------------|
| 36.23 | <i>AL1 30 to 40%</i> | Displays the percentage of samples recorded by amplitude logger 1 that fall between 30 and 40%.   | 0.00%      |
|       | 0.00 ... 100.00%     | Amplitude logger 1 samples between 30 and 40%.  | 1 = 1%     |
| 36.24 | <i>AL1 40 to 50%</i> | Displays the percentage of samples recorded by amplitude logger 1 that fall between 40 and 50%.   | 0.00%      |
|       | 0.00 ... 100.00%     | Amplitude logger 1 samples between 40 and 50%.  | 1 = 1%     |
| 36.25 | <i>AL1 50 to 60%</i> | Displays the percentage of samples recorded by amplitude logger 1 that fall between 50 and 60%.   | 0.00%      |
|       | 0.00 ... 100.00%     | Amplitude logger 1 samples between 50 and 60%.  | 1 = 1%     |
| 36.26 | <i>AL1 60 to 70%</i> | Displays the percentage of samples recorded by amplitude logger 1 that fall between 60 and 70%.   | 0.00%      |
|       | 0.00 ... 100.00%     | Amplitude logger 1 samples between 60 and 70%.  | 1 = 1%     |
| 36.27 | <i>AL1 70 to 80%</i> | Displays the percentage of samples recorded by amplitude logger 1 that fall between 70 and 80%.   | 0.00%      |
|       | 0.00 ... 100.00%     | Amplitude logger 1 samples between 70 and 80%.  | 1 = 1%     |
| 36.28 | <i>AL1 80 to 90%</i> | Displays the percentage of samples recorded by amplitude logger 1 that fall between 80 and 90%.   | 0.00%      |
|       | 0.00 ... 100.00%     | Amplitude logger 1 samples between 80 and 90%.  | 1 = 1%     |
| 36.29 | <i>AL1 over 90%</i>  | Displays the percentage of samples recorded by amplitude logger 1 that exceed 90%.  | 0.00%      |
|       | 0.00 ... 100.00%     | Amplitude logger 1 samples over 90%.  | 1 = 1%     |
| 36.40 | <i>AL2 below 10%</i> | Displays the percentage of samples recorded by amplitude logger 2 that were below 10%. Note that this percentage also includes the samples that had a negative value. | 0.00%      |
|       | 0.00 ... 100.00%     | Amplitude logger 2 samples below 10%.   | 1 = 1%     |
| 36.41 | <i>AL2 10 to 20%</i> | Displays the percentage of samples recorded by amplitude logger 2 that fall between 10 and 20%.   | 0.00%      |
|       | 0.00 ... 100.00%     | Amplitude logger 2 samples between 10 and 20%.  | 1 = 1%     |
| 36.42 | <i>AL2 20 to 30%</i> | Displays the percentage of samples recorded by amplitude logger 2 that fall between 20 and 30%.   | 0.00%      |
|       | 0.00 ... 100.00%     | Amplitude logger 2 samples between 20 and 30%.  | 1 = 1%     |
| 36.43 | <i>AL2 30 to 40%</i> | Displays the percentage of samples recorded by amplitude logger 2 that fall between 30 and 40%.   | 0.00%      |
|       | 0.00 ... 100.00%     | Amplitude logger 2 samples between 30 and 40%.  | 1 = 1%     |
| 36.44 | <i>AL2 40 to 50%</i> | Displays the percentage of samples recorded by amplitude logger 2 that fall between 40 and 50%.   | 0.00%      |
|       | 0.00 ... 100.00%     | Amplitude logger 2 samples between 40 and 50%.  | 1 = 1%     |
| 36.45 | <i>AL2 50 to 60%</i> | Displays the percentage of samples recorded by amplitude logger 2 that fall between 50 and 60%.   | 0.00%      |
|       | 0.00 ... 100.00%     | Amplitude logger 2 samples between 50 and 60%.  | 1 = 1%     |
| 36.46 | <i>AL2 60 to 70%</i> | Displays the percentage of samples recorded by amplitude logger 2 that fall between 60 and 70%.   | 0.00%      |
|       | 0.00 ... 100.00%     | Amplitude logger 2 samples between 60 and 70%.  | 1 = 1%     |
| 36.47 | <i>AL2 70 to 80%</i> | Displays the percentage of samples recorded by amplitude logger 2 that fall between 70 and 80%.   | 0.00%      |
|       | 0.00 ... 100.00%     | Amplitude logger 2 samples between 70 and 80%.  | 1 = 1%     |

| No.   | Name/Value            | Description   | Def/FbEq16 |
|-------|-----------------------|---|------------|
| 36.48 | <i>AL2 80 to 90%</i>  | Displays the percentage of samples recorded by amplitude logger 2 that fall between 80 and 90%. | 0.00%      |
|       | 0.00 ... 100.00%      | Amplitude logger 2 samples between 80 and 90%.  | 1 = 1%     |
| 36.49 | <i>AL2 over 90%</i>   | Displays the percentage of samples recorded by amplitude logger 2 that exceed 90%.              | 0.00%      |
|       | 0.00 ... 100.00%      | Amplitude logger 2 samples over 90%.  | 1 = 1%     |
| 36.50 | <i>AL2 reset date</i> | Displays the date on which amplitude logger 2 was last reset.                                   | -          |
|       | -                     | Last reset date of amplitude logger 2.  | -          |
| 36.51 | <i>AL2 reset time</i> | Displays the time at which amplitude logger 2 was last reset.                                   | -          |
|       | -                     | Last reset time of amplitude logger 2.  | -          |

|                           |  |  |
|---------------------------|--|--|
| <b>37 User load curve</b> | Settings for user load curve.<br>See also section <a href="#">User load curve</a> (page 83). |  |
|---------------------------|--|--|

|       |                               |  |   |
|-------|-------------------------------|--|---|
| 37.01 | <i>ULC output status word</i> | Displays the status of the monitored signal. (The status word is independent of the actions and delays selected by parameters <a href="#">37.03</a> , <a href="#">37.04</a> , <a href="#">37.41</a> and <a href="#">37.42</a> .)<br>This parameter is read-only. | - |
|-------|-------------------------------|--|---|

| Bit    | Name             | Information                                       |
|--------|------------------|---|
| 0      | Under load limit | 1 = Monitored signal is below the underload curve |
| 1      | Reserved         |   |
| 2      | Over load limit  | 1 = Monitored signal is above the overload curve  |
| 3...15 | Reserved         |   |

|               |  |                                 |       |
|---------------|--|---------------------------------|-------|
| 000b ... 101b |  | Status of the monitored signal. | 1 = 1 |
|---------------|--|---------------------------------|-------|

|       |                               |  |                     |
|-------|-------------------------------|--|---------------------|
| 37.02 | <i>ULC supervision signal</i> | Selects the signal to be monitored. The function compares the absolute value of the signal against the load curve. | <i>Not selected</i> |
|-------|-------------------------------|--|---------------------|

|  |              |   |   |
|--|--------------|---|---|
|  | Not selected | No signal selected (monitoring disabled). | 0 |
|--|--------------|---|---|

|  |                 |   |   |
|--|-----------------|---|---|
|  | Motor current % | <a href="#">01.07 Motor current</a> (see page 115). | 2 |
|--|-----------------|---|---|

|  |                |  |   |
|--|----------------|--|---|
|  | Motor torque % | <a href="#">01.10 Motor torque</a> (see page 115). | 3 |
|--|----------------|--|---|

|  |                                 |   |   |
|--|---------------------------------|---|---|
|  | Output power % of motor nominal | <a href="#">01.15 Output power % of motor nom</a> (see page 116). | 4 |
|--|---------------------------------|---|---|

|  |              |   |   |
|--|--------------|---|---|
|  | <i>Other</i> | Source selection (see <a href="#">Terms and abbreviations</a> on page 112). | - |
|--|--------------|---|---|

|       |                             |   |                 |
|-------|-----------------------------|---|-----------------|
| 37.03 | <i>ULC overload actions</i> | Selects how the drive reacts if the absolute value of the monitored signal stays above the overload curve for longer than the value of <a href="#">37.41 ULC overload timer</a> . | <i>Disabled</i> |
|-------|-----------------------------|---|-----------------|

|  |          |                  |   |
|--|----------|------------------|---|
|  | Disabled | No action taken. | 0 |
|--|----------|------------------|---|

|  |         |  |   |
|--|---------|--|---|
|  | Warning | The drive generates a warning ( <a href="#">A8BE ULC overload warning</a> ). | 1 |
|--|---------|--|---|

|  |       |  |   |
|--|-------|--|---|
|  | Fault | Drive trips on <a href="#">8002 ULC overload fault</a> . | 2 |
|--|-------|--|---|

|  |               |   |   |
|--|---------------|---|---|
|  | Warning/Fault | The drive generates a warning ( <a href="#">A8BE ULC overload warning</a> ) if the signal stays continuously above the overload curve for half of the time defined by <a href="#">37.41 ULC overload timer</a> .<br>The drive trips on <a href="#">8002 ULC overload fault</a> if the signal stays continuously above the overload curve for the time defined by <a href="#">37.41 ULC overload timer</a> . | 3 |
|--|---------------|---|---|

| No.   | Name/Value                         | Description   | Def/FbEq16      |
|-------|------------------------------------|---|-----------------|
| 37.04 | <i>ULC underload actions</i>       | Selects how the drive reacts if the absolute value of the monitored signal stays below the underload curve for longer than the value of <i>37.42 ULC underload timer</i> .  | <i>Disabled</i> |
|       | Disabled                           | No action taken.  | 0               |
|       | Warning                            | The drive generates a warning ( <i>A8BF ULC underload warning</i> ).  | 1               |
|       | Fault                              | Drive trips on <i>8001 ULC underload fault</i> .  | 2               |
|       | Warning/Fault                      | The drive generates a warning ( <i>A8BF ULC underload warning</i> ) if the signal stays continuously below the underload curve for half of the time defined by <i>37.42 ULC underload timer</i> .<br>The drive trips on <i>8001 ULC underload fault</i> if the signal stays continuously below the underload curve for the time defined by <i>37.42 ULC underload timer</i> .   | 3               |
| 37.11 | <i>ULC speed table point 1</i>     | Defines the 1st speed point on the X-axis of the user load curve.<br>The speed points are used in DTC motor control mode, and in scalar motor control mode when speed control is being used. The five points must be in order from lowest to highest. The points are defined as positive values, but the range is symmetrically effective also in the negative direction. The monitoring is not active outside these two areas. | 150.0 rpm       |
|       | 0.0 ... 30000.0 rpm                | Speed.  | 1 = 1 rpm       |
| 37.12 | <i>ULC speed table point 2</i>     | Defines the 2nd speed point on the X-axis of the user load curve.   | 750.0 rpm       |
|       | 0.0 ... 30000.0 rpm                | Speed.  | 1 = 1 rpm       |
| 37.13 | <i>ULC speed table point 3</i>     | Defines the 3rd speed point on the X-axis of the user load curve.   | 1290.0 rpm      |
|       | 0.0 ... 30000.0 rpm                | Speed.  | 1 = 1 rpm       |
| 37.14 | <i>ULC speed table point 4</i>     | Defines the 4th speed point on the X-axis of the user load curve.   | 1500.0 rpm      |
|       | 0.0 ... 30000.0 rpm                | Speed.  | 1 = 1 rpm       |
| 37.15 | <i>ULC speed table point 5</i>     | Defines the 5th speed point on the X-axis of the user load curve.   | 1800.0 rpm      |
|       | 0.0 ... 30000.0 rpm                | Speed.  | 1 = 1 rpm       |
| 37.16 | <i>ULC frequency table point 1</i> | Defines the 1st frequency point on the X-axis of the user load curve.<br>The frequency points are used in scalar motor control mode when frequency control is being used. The five points must be in order from lowest to highest. The points are defined as positive values, but the range is symmetrically effective also in the negative direction. The monitoring is not active outside these two areas.                    | 5.0 Hz          |
|       | 0.0 ... 500.0 Hz                   | Frequency.  | 1 = 1 Hz        |
| 37.17 | <i>ULC frequency table point 2</i> | Defines the 2nd frequency point on the X-axis of the user load curve.   | 25.0 Hz         |
|       | 0.0 ... 500.0 Hz                   | Frequency.  | 1 = 1 Hz        |
| 37.18 | <i>ULC frequency table point 3</i> | Defines the 3rd frequency point on the X-axis of the user load curve.   | 43.0 Hz         |
|       | 0.0 ... 500.0 Hz                   | Frequency.  | 1 = 1 Hz        |

## 300 Parameters

| No.   | Name/Value                                  | Description  | Def/FbEq16 |
|-------|---|--|------------|
| 37.19 | <a href="#">ULC frequency table point 4</a> | Defines the 4th frequency point on the X-axis of the user load curve.  | 50.0 Hz    |
|       | 0.0 ... 500.0 Hz                            | Frequency.   | 1 = 1 Hz   |
| 37.20 | <a href="#">ULC frequency table point 5</a> | Defines the 5th frequency point on the X-axis of the user load curve.  | 60.0 Hz    |
|       | 0.0 ... 500.0 Hz                            | Frequency.   | 1 = 1 Hz   |
| 37.21 | <a href="#">ULC underload point 1</a>       | Defines the 1st point of the underload curve.<br>Each point of the underload curve must have a lower value than the corresponding overload point.  | 10.0%      |
|       | 0.0 ... 1600.0%                             | Underload point.   | 1 = 1%     |
| 37.22 | <a href="#">ULC underload point 2</a>       | Defines the 2nd point of the underload curve.  | 15.0%      |
|       | 0.0 ... 1600.0%                             | Underload point.   | 1 = 1%     |
| 37.23 | <a href="#">ULC underload point 3</a>       | Defines the 3rd point of the underload curve.  | 25.0%      |
|       | 0.0 ... 1600.0%                             | Underload point.   | 1 = 1%     |
| 37.24 | <a href="#">ULC underload point 4</a>       | Defines the 4th point of the underload curve.  | 30.0%      |
|       | 0.0 ... 1600.0%                             | Underload point.   | 1 = 1%     |
| 37.25 | <a href="#">ULC underload point 5</a>       | Defines the 5th point of the underload curve.  | 30.0%      |
|       | 0.0 ... 1600.0%                             | Underload point.   | 1 = 1%     |
| 37.31 | <a href="#">ULC overload point 1</a>        | Defines the 1st point of the overload curve.<br>Each point of the overload curve must have a higher value than the corresponding underload point.  | 300.0%     |
|       | 0.0 ... 1600.0%                             | Overload point.  | 1 = 1%     |
| 37.32 | <a href="#">ULC overload point 2</a>        | Defines the 2nd point of the overload curve.   | 300.0%     |
|       | 0.0 ... 1600.0%                             | Overload point.  | 1 = 1%     |
| 37.33 | <a href="#">ULC overload point 3</a>        | Defines the 3rd point of the overload curve.   | 300.0%     |
|       | 0.0 ... 1600.0%                             | Overload point.  | 1 = 1%     |
| 37.34 | <a href="#">ULC overload point 4</a>        | Defines the 4th point of the overload curve.   | 300.0%     |
|       | 0.0 ... 1600.0%                             | Overload point.  | 1 = 1%     |
| 37.35 | <a href="#">ULC overload point 5</a>        | Defines the 5th point of the overload curve.   | 300.0%     |
|       | 0.0 ... 1600.0%                             | Overload point.  | 1 = 1%     |
| 37.41 | <a href="#">ULC overload timer</a>          | Defines the time for which the monitored signal must continuously stay above the overload curve before the drive takes the action selected by <a href="#">37.03 ULC overload actions</a> .   | 20.0 s     |
|       | 0.0 ... 10000.0 s                           | Overload timer.  | 1 = 1 s    |
| 37.42 | <a href="#">ULC underload timer</a>         | Defines the time for which the monitored signal must continuously stay below the underload curve before the drive takes the action selected by <a href="#">37.04 ULC underload actions</a> . | 20.0 s     |
|       | 0.0 ... 10000.0 s                           | Underload timer.   | 1 = 1 s    |

| No.   | Name/Value                                   | Description   | Def/FbEq16 |
|---|--|---|------------|
| <p><b>40 Process PID set 1</b></p> <p>Parameter values for process PID control. The drive contains a single active PID controller for process use, however two separate complete set-ups can be programmed and stored. The first set is made up of parameters <a href="#">40.07...40.56*</a>, the second set is defined by the parameters in group <a href="#">41 Process PID set 2</a>. The binary source that defines which set is used is selected by parameter <a href="#">40.57 PID set1/set2 selection</a>. See also the control chain diagrams on pages <a href="#">578</a> and <a href="#">579</a>. *The remaining parameters in this group are common for both sets.</p> |  |   |            |
| 40.01   | <a href="#">Process PID output actual</a>    | Displays the output of the process PID controller. See the control chain diagram on page <a href="#">579</a> . This parameter is read-only. The unit is selected by parameter <a href="#">40.12 Set 1 unit selection</a> .  | -          |
| -32768.00 ...<br>32767.00   |  | Process PID controller output.  | 1 = 1 unit |
| 40.02   | <a href="#">Process PID feedback actual</a>  | Displays the value of process feedback after source selection, mathematical function (parameter <a href="#">40.10 Set 1 feedback function</a> ), and filtering. See the control chain diagram on page <a href="#">578</a> . This parameter is read-only. The unit is selected by parameter <a href="#">40.12 Set 1 unit selection</a> .                     | -          |
| -32768.00 ...<br>32767.00   |  | Process feedback.   | 1 = 1 unit |
| 40.03   | <a href="#">Process PID setpoint actual</a>  | Displays the value of process PID setpoint after source selection, mathematical function ( <a href="#">40.18 Set 1 setpoint function</a> ), limitation and ramping. See the control chain diagram on page <a href="#">579</a> . This parameter is read-only. The unit is selected by parameter <a href="#">40.12 Set 1 unit selection</a> .                 | -          |
| -32768.00 ...<br>32767.00   |  | Setpoint for process PID controller.  | 1 = 1 unit |
| 40.04   | <a href="#">Process PID deviation actual</a> | Displays the process PID deviation. By default, this value equals setpoint - feedback, but deviation can be inverted by parameter <a href="#">40.31 Set 1 deviation inversion</a> . See the control chain diagram on page <a href="#">579</a> . This parameter is read-only. The unit is selected by parameter <a href="#">40.12 Set 1 unit selection</a> . | -          |
| -32768.00 ...<br>32767.00   |  | PID deviation.  | 1 = 1 unit |
| 40.05   | <a href="#">Process PID trim output act</a>  | Displays the trimmed reference output. See the control chain diagram on page <a href="#">579</a> . This parameter is read-only. The unit is selected by parameter <a href="#">40.12 Set 1 unit selection</a> .  | -          |
| -32768.00 ...<br>32767.00   |  | Trimmed reference.  | 1 = 1 unit |

| No.     | Name/Value                      | Description  | Def/FbEq16          |      |       |   |            |                                 |   |                 |                                  |   |               |   |   |                |                        |   |             |                         |   |           |                           |   |               |                               |   |                   |   |   |                  |   |   |                 |   |    |         |   |    |          |  |    |                          |  |         |          |  |  |
|---------|---------------------------------|--|---------------------|------|-------|---|------------|---------------------------------|---|-----------------|----------------------------------|---|---------------|---|---|----------------|------------------------|---|-------------|-------------------------|---|-----------|---------------------------|---|---------------|-------------------------------|---|-------------------|---|---|------------------|---|---|-----------------|---|----|---------|---|----|----------|--|----|--------------------------|--|---------|----------|--|--|
| 40.06   | <i>Process PID status word</i>  | Displays status information on process PID control.<br>This parameter is read-only.  | -                   |      |       |   |            |                                 |   |                 |                                  |   |               |   |   |                |                        |   |             |                         |   |           |                           |   |               |                               |   |                   |   |   |                  |   |   |                 |   |    |         |   |    |          |  |    |                          |  |         |          |  |  |
|         |                                 | <table border="1"> <thead> <tr> <th>Bit</th> <th>Name</th> <th>Value</th> </tr> </thead> <tbody> <tr> <td>0</td> <td>PID active</td> <td>1 = Process PID control active.</td> </tr> <tr> <td>1</td> <td>Setpoint frozen</td> <td>1 = Process PID setpoint frozen.</td> </tr> <tr> <td>2</td> <td>Output frozen</td> <td>1 = Process PID controller output frozen.</td> </tr> <tr> <td>3</td> <td>PID sleep mode</td> <td>1 = Sleep mode active.</td> </tr> <tr> <td>4</td> <td>Sleep boost</td> <td>1 = Sleep boost active.</td> </tr> <tr> <td>5</td> <td>Trim mode</td> <td>1 = Trim function active.</td> </tr> <tr> <td>6</td> <td>Tracking mode</td> <td>1 = Tracking function active.</td> </tr> <tr> <td>7</td> <td>Output limit high</td> <td>1 = PID output is being limited by par. <a href="#">40.37</a>.</td> </tr> <tr> <td>8</td> <td>Output limit low</td> <td>1 = PID output is being limited by par. <a href="#">40.36</a>.</td> </tr> <tr> <td>9</td> <td>Deadband active</td> <td>1 = Deadband active (see par. <a href="#">40.39</a>)</td> </tr> <tr> <td>10</td> <td>PID set</td> <td>0 = Parameter set 1 in use. 1 = Parameter set 2 in use.</td> </tr> <tr> <td>11</td> <td>Reserved</td> <td></td> </tr> <tr> <td>12</td> <td>Internal setpoint active</td> <td>1 = Internal setpoint active (see par. <a href="#">40.16...40.16</a>)</td> </tr> <tr> <td>13...15</td> <td>Reserved</td> <td></td> </tr> </tbody> </table> | Bit                 | Name | Value | 0 | PID active | 1 = Process PID control active. | 1 | Setpoint frozen | 1 = Process PID setpoint frozen. | 2 | Output frozen | 1 = Process PID controller output frozen. | 3 | PID sleep mode | 1 = Sleep mode active. | 4 | Sleep boost | 1 = Sleep boost active. | 5 | Trim mode | 1 = Trim function active. | 6 | Tracking mode | 1 = Tracking function active. | 7 | Output limit high | 1 = PID output is being limited by par. <a href="#">40.37</a> . | 8 | Output limit low | 1 = PID output is being limited by par. <a href="#">40.36</a> . | 9 | Deadband active | 1 = Deadband active (see par. <a href="#">40.39</a> ) | 10 | PID set | 0 = Parameter set 1 in use. 1 = Parameter set 2 in use. | 11 | Reserved |  | 12 | Internal setpoint active | 1 = Internal setpoint active (see par. <a href="#">40.16...40.16</a> ) | 13...15 | Reserved |  |  |
| Bit     | Name                            | Value  |                     |      |       |   |            |                                 |   |                 |                                  |   |               |   |   |                |                        |   |             |                         |   |           |                           |   |               |                               |   |                   |   |   |                  |   |   |                 |   |    |         |   |    |          |  |    |                          |  |         |          |  |  |
| 0       | PID active                      | 1 = Process PID control active.  |                     |      |       |   |            |                                 |   |                 |                                  |   |               |   |   |                |                        |   |             |                         |   |           |                           |   |               |                               |   |                   |   |   |                  |   |   |                 |   |    |         |   |    |          |  |    |                          |  |         |          |  |  |
| 1       | Setpoint frozen                 | 1 = Process PID setpoint frozen.   |                     |      |       |   |            |                                 |   |                 |                                  |   |               |   |   |                |                        |   |             |                         |   |           |                           |   |               |                               |   |                   |   |   |                  |   |   |                 |   |    |         |   |    |          |  |    |                          |  |         |          |  |  |
| 2       | Output frozen                   | 1 = Process PID controller output frozen.  |                     |      |       |   |            |                                 |   |                 |                                  |   |               |   |   |                |                        |   |             |                         |   |           |                           |   |               |                               |   |                   |   |   |                  |   |   |                 |   |    |         |   |    |          |  |    |                          |  |         |          |  |  |
| 3       | PID sleep mode                  | 1 = Sleep mode active.   |                     |      |       |   |            |                                 |   |                 |                                  |   |               |   |   |                |                        |   |             |                         |   |           |                           |   |               |                               |   |                   |   |   |                  |   |   |                 |   |    |         |   |    |          |  |    |                          |  |         |          |  |  |
| 4       | Sleep boost                     | 1 = Sleep boost active.  |                     |      |       |   |            |                                 |   |                 |                                  |   |               |   |   |                |                        |   |             |                         |   |           |                           |   |               |                               |   |                   |   |   |                  |   |   |                 |   |    |         |   |    |          |  |    |                          |  |         |          |  |  |
| 5       | Trim mode                       | 1 = Trim function active.  |                     |      |       |   |            |                                 |   |                 |                                  |   |               |   |   |                |                        |   |             |                         |   |           |                           |   |               |                               |   |                   |   |   |                  |   |   |                 |   |    |         |   |    |          |  |    |                          |  |         |          |  |  |
| 6       | Tracking mode                   | 1 = Tracking function active.  |                     |      |       |   |            |                                 |   |                 |                                  |   |               |   |   |                |                        |   |             |                         |   |           |                           |   |               |                               |   |                   |   |   |                  |   |   |                 |   |    |         |   |    |          |  |    |                          |  |         |          |  |  |
| 7       | Output limit high               | 1 = PID output is being limited by par. <a href="#">40.37</a> .  |                     |      |       |   |            |                                 |   |                 |                                  |   |               |   |   |                |                        |   |             |                         |   |           |                           |   |               |                               |   |                   |   |   |                  |   |   |                 |   |    |         |   |    |          |  |    |                          |  |         |          |  |  |
| 8       | Output limit low                | 1 = PID output is being limited by par. <a href="#">40.36</a> .  |                     |      |       |   |            |                                 |   |                 |                                  |   |               |   |   |                |                        |   |             |                         |   |           |                           |   |               |                               |   |                   |   |   |                  |   |   |                 |   |    |         |   |    |          |  |    |                          |  |         |          |  |  |
| 9       | Deadband active                 | 1 = Deadband active (see par. <a href="#">40.39</a> )  |                     |      |       |   |            |                                 |   |                 |                                  |   |               |   |   |                |                        |   |             |                         |   |           |                           |   |               |                               |   |                   |   |   |                  |   |   |                 |   |    |         |   |    |          |  |    |                          |  |         |          |  |  |
| 10      | PID set                         | 0 = Parameter set 1 in use. 1 = Parameter set 2 in use.  |                     |      |       |   |            |                                 |   |                 |                                  |   |               |   |   |                |                        |   |             |                         |   |           |                           |   |               |                               |   |                   |   |   |                  |   |   |                 |   |    |         |   |    |          |  |    |                          |  |         |          |  |  |
| 11      | Reserved                        |  |                     |      |       |   |            |                                 |   |                 |                                  |   |               |   |   |                |                        |   |             |                         |   |           |                           |   |               |                               |   |                   |   |   |                  |   |   |                 |   |    |         |   |    |          |  |    |                          |  |         |          |  |  |
| 12      | Internal setpoint active        | 1 = Internal setpoint active (see par. <a href="#">40.16...40.16</a> )   |                     |      |       |   |            |                                 |   |                 |                                  |   |               |   |   |                |                        |   |             |                         |   |           |                           |   |               |                               |   |                   |   |   |                  |   |   |                 |   |    |         |   |    |          |  |    |                          |  |         |          |  |  |
| 13...15 | Reserved                        |  |                     |      |       |   |            |                                 |   |                 |                                  |   |               |   |   |                |                        |   |             |                         |   |           |                           |   |               |                               |   |                   |   |   |                  |   |   |                 |   |    |         |   |    |          |  |    |                          |  |         |          |  |  |
|         | 0000h...FFFFh                   | Process PID control status word.   | 1 = 1               |      |       |   |            |                                 |   |                 |                                  |   |               |   |   |                |                        |   |             |                         |   |           |                           |   |               |                               |   |                   |   |   |                  |   |   |                 |   |    |         |   |    |          |  |    |                          |  |         |          |  |  |
| 40.07   | <i>Set 1 PID operation mode</i> | Activates/deactivates process PID control. See also parameter <a href="#">40.60 Set 1 PID activation source</a> .<br><b>Note:</b> Process PID control is only available in external control; see section <a href="#">Local control vs. external control</a> (page 20).   | <i>Off</i>          |      |       |   |            |                                 |   |                 |                                  |   |               |   |   |                |                        |   |             |                         |   |           |                           |   |               |                               |   |                   |   |   |                  |   |   |                 |   |    |         |   |    |          |  |    |                          |  |         |          |  |  |
|         | Off                             | Process PID control inactive.  | 0                   |      |       |   |            |                                 |   |                 |                                  |   |               |   |   |                |                        |   |             |                         |   |           |                           |   |               |                               |   |                   |   |   |                  |   |   |                 |   |    |         |   |    |          |  |    |                          |  |         |          |  |  |
|         | On                              | Process PID control active.  | 1                   |      |       |   |            |                                 |   |                 |                                  |   |               |   |   |                |                        |   |             |                         |   |           |                           |   |               |                               |   |                   |   |   |                  |   |   |                 |   |    |         |   |    |          |  |    |                          |  |         |          |  |  |
|         | On when drive running           | Process PID control is active when the drive is running.   | 2                   |      |       |   |            |                                 |   |                 |                                  |   |               |   |   |                |                        |   |             |                         |   |           |                           |   |               |                               |   |                   |   |   |                  |   |   |                 |   |    |         |   |    |          |  |    |                          |  |         |          |  |  |
| 40.08   | <i>Set 1 feedback 1 source</i>  | Selects the first source of process feedback. See the control chain diagram on page <a href="#">578</a> .  | <i>AI1 scaled</i>   |      |       |   |            |                                 |   |                 |                                  |   |               |   |   |                |                        |   |             |                         |   |           |                           |   |               |                               |   |                   |   |   |                  |   |   |                 |   |    |         |   |    |          |  |    |                          |  |         |          |  |  |
|         | Not selected                    | None.  | 0                   |      |       |   |            |                                 |   |                 |                                  |   |               |   |   |                |                        |   |             |                         |   |           |                           |   |               |                               |   |                   |   |   |                  |   |   |                 |   |    |         |   |    |          |  |    |                          |  |         |          |  |  |
|         | AI1 scaled                      | <a href="#">12.12 AI1 scaled value</a> (see page <a href="#">158</a> ).  | 1                   |      |       |   |            |                                 |   |                 |                                  |   |               |   |   |                |                        |   |             |                         |   |           |                           |   |               |                               |   |                   |   |   |                  |   |   |                 |   |    |         |   |    |          |  |    |                          |  |         |          |  |  |
|         | AI2 scaled                      | <a href="#">12.22 AI2 scaled value</a> (see page <a href="#">160</a> ).  | 2                   |      |       |   |            |                                 |   |                 |                                  |   |               |   |   |                |                        |   |             |                         |   |           |                           |   |               |                               |   |                   |   |   |                  |   |   |                 |   |    |         |   |    |          |  |    |                          |  |         |          |  |  |
|         | Freq in scaled                  | <a href="#">11.39 Freq in 1 scaled</a> (see page <a href="#">154</a> ).  | 3                   |      |       |   |            |                                 |   |                 |                                  |   |               |   |   |                |                        |   |             |                         |   |           |                           |   |               |                               |   |                   |   |   |                  |   |   |                 |   |    |         |   |    |          |  |    |                          |  |         |          |  |  |
|         | Motor current                   | <a href="#">01.07 Motor current</a> (see page <a href="#">115</a> ).   | 5                   |      |       |   |            |                                 |   |                 |                                  |   |               |   |   |                |                        |   |             |                         |   |           |                           |   |               |                               |   |                   |   |   |                  |   |   |                 |   |    |         |   |    |          |  |    |                          |  |         |          |  |  |
|         | Power inu out                   | <a href="#">01.14 Output power</a> (see page <a href="#">116</a> ).  | 6                   |      |       |   |            |                                 |   |                 |                                  |   |               |   |   |                |                        |   |             |                         |   |           |                           |   |               |                               |   |                   |   |   |                  |   |   |                 |   |    |         |   |    |          |  |    |                          |  |         |          |  |  |
|         | Motor torque                    | <a href="#">01.10 Motor torque</a> (see page <a href="#">115</a> ).  | 7                   |      |       |   |            |                                 |   |                 |                                  |   |               |   |   |                |                        |   |             |                         |   |           |                           |   |               |                               |   |                   |   |   |                  |   |   |                 |   |    |         |   |    |          |  |    |                          |  |         |          |  |  |
|         | Feedback data storage           | <a href="#">40.91 Feedback data storage</a> (see page <a href="#">313</a> ).   | 10                  |      |       |   |            |                                 |   |                 |                                  |   |               |   |   |                |                        |   |             |                         |   |           |                           |   |               |                               |   |                   |   |   |                  |   |   |                 |   |    |         |   |    |          |  |    |                          |  |         |          |  |  |
|         | <i>Other</i>                    | Source selection (see <a href="#">Terms and abbreviations</a> on page <a href="#">112</a> ).   | -                   |      |       |   |            |                                 |   |                 |                                  |   |               |   |   |                |                        |   |             |                         |   |           |                           |   |               |                               |   |                   |   |   |                  |   |   |                 |   |    |         |   |    |          |  |    |                          |  |         |          |  |  |
| 40.09   | <i>Set 1 feedback 2 source</i>  | Selects the second source of process feedback.<br>For the selections, see parameter <a href="#">40.08 Set 1 feedback 1 source</a> .  | <i>Not selected</i> |      |       |   |            |                                 |   |                 |                                  |   |               |   |   |                |                        |   |             |                         |   |           |                           |   |               |                               |   |                   |   |   |                  |   |   |                 |   |    |         |   |    |          |  |    |                          |  |         |          |  |  |

| No.   | Name/Value                        | Description   | Def/FbEq16   |
|-------|-----------------------------------|---|--|
| 40.10 | <i>Set 1 feedback function</i>    | Defines how process feedback is calculated from the two feedback sources selected by parameters <a href="#">40.08 Set 1 feedback 1 source</a> and <a href="#">40.09 Set 1 feedback 2 source</a> .   | <i>In1</i>   |
|       | In1                               | Source 1.   | 0  |
|       | In1+In2                           | Sum of sources 1 and 2.   | 1  |
|       | In1-In2                           | Source 2 subtracted from source 1.  | 2  |
|       | In1*In2                           | Source 1 multiplied by source 2.  | 3  |
|       | In1/In2                           | Source 1 divided by source 2.   | 4  |
|       | MIN(In1,In2)                      | Smaller of the two sources.   | 5  |
|       | MAX(In1,In2)                      | Greater of the two sources.   | 6  |
|       | AVE(In1,In2)                      | Average of the two sources.   | 7  |
|       | sqrt(In1)                         | Square root of source 1.  | 8  |
|       | sqrt(In1-In2)                     | Square root of (source 1 - source 2).   | 9  |
|       | sqrt(In1+In2)                     | Square root of (source 1 + source 2).   | 10   |
|       | sqrt(In1)+sqrt(In2)               | Square root of source 1 + square root of source 2.  | 11   |
| 40.11 | <i>Set 1 feedback filter time</i> | Defines the filter time constant for process feedback.  | 0.000 s  |
|       | 0.000 ... 30.000 s                | Feedback filter time.   | 1 = 1 s  |
| 40.12 | <i>Set 1 unit selection</i>       | Defines the unit for parameters <a href="#">40.01...40.05</a> , <a href="#">40.21...40.24</a> and <a href="#">40.47</a> .   | %  |
|       | rpm                               | rpm.  | 7  |
|       | %                                 | %.  | 4  |
|       | Hz                                | Hz.   | 3  |
|       | PID user unit 1                   | User-definable unit 1. The name of the unit can be edited on the control panel by choosing Menu – Settings – Edit texts.  | 250  |
| 40.14 | <i>Set 1 setpoint scaling</i>     | Defines, together with parameter <a href="#">40.15 Set 1 output scaling</a> , a general scaling factor for the process PID control chain. The scaling can be utilized when, for example, the process setpoint is input in Hz, and the output of the PID controller is used as an rpm value in speed control. In this case, this parameter might be set to 50, and parameter <a href="#">40.15</a> to the nominal motor speed at 50 Hz.<br>In effect, the output of the PID controller = [ <a href="#">40.15</a> ] when deviation (setpoint - feedback) = [ <a href="#">40.14</a> ] and [ <a href="#">40.32</a> ] = 1.<br><b>Note:</b> The scaling is based on the ratio between <a href="#">40.14</a> and <a href="#">40.15</a> . For example, the values 50 and 1500 would produce the same scaling as 1 and 30. | 100.00   |
|       | -32768.00 ... 32767.00            | Process setpoint base.  | 1 = 1  |
| 40.15 | <i>Set 1 output scaling</i>       | See parameter <a href="#">40.14 Set 1 setpoint scaling</a> .  | 1500.00;<br>1800.00<br>( <a href="#">95.20</a> b0) |
|       | -32768.00 ... 32767.00            | Process PID controller output base.   | 1 = 1  |
| 40.16 | <i>Set 1 setpoint 1 source</i>    | Selects the first source of process PID setpoint. This setpoint is available in parameter <a href="#">40.25 Set 1 setpoint selection</a> as setpoint 1. See the control chain diagram on page <a href="#">578</a> .   | <i>Internal setpoint</i>                           |
|       | Not selected                      | None.   | 0  |



| No.  | Name/Value                                   | Description  | Def/FbEq16                                   |  |                        |   |   |                                 |   |   |                                 |   |   |                                 |   |   |                                 |                     |
|--|--|--|--|--|------------------------|---|---|---------------------------------|---|---|---------------------------------|---|---|---------------------------------|---|---|---------------------------------|---------------------|
|  | Control panel                                | <a href="#">03.01 Panel reference</a> (see page 119). See section <a href="#">Using the control panel as an external control source</a> (page 21).   | 1  |  |                        |   |   |                                 |   |   |                                 |   |   |                                 |   |   |                                 |                     |
|  | Internal setpoint                            | Internal setpoint. See parameter <a href="#">40.19 Set 1 internal setpoint sel1</a> .  | 2  |  |                        |   |   |                                 |   |   |                                 |   |   |                                 |   |   |                                 |                     |
|  | AI1 scaled                                   | <a href="#">12.12 AI1 scaled value</a> (see page 158).   | 3  |  |                        |   |   |                                 |   |   |                                 |   |   |                                 |   |   |                                 |                     |
|  | AI2 scaled                                   | <a href="#">12.22 AI2 scaled value</a> (see page 160).   | 4  |  |                        |   |   |                                 |   |   |                                 |   |   |                                 |   |   |                                 |                     |
|  | Motor potentiometer                          | <a href="#">22.80 Motor potentiometer ref act</a> (output of the motor potentiometer).   | 8  |  |                        |   |   |                                 |   |   |                                 |   |   |                                 |   |   |                                 |                     |
|  | Freq in scaled                               | <a href="#">11.39 Freq in 1 scaled</a> (see page 154).   | 10   |  |                        |   |   |                                 |   |   |                                 |   |   |                                 |   |   |                                 |                     |
|  | Setpoint data storage                        | <a href="#">40.92 Setpoint data storage</a> (see page 313).  | 24   |  |                        |   |   |                                 |   |   |                                 |   |   |                                 |   |   |                                 |                     |
|  | <i>Other</i>                                 | Source selection (see <a href="#">Terms and abbreviations</a> on page 112).  | -  |  |                        |   |   |                                 |   |   |                                 |   |   |                                 |   |   |                                 |                     |
| <a href="#">40.17</a>                        | <a href="#">Set 1 setpoint 2 source</a>      | Selects the second source of process setpoint. This setpoint is available in parameter <a href="#">40.25 Set 1 setpoint selection</a> as setpoint 2.<br>For the selections, see parameter <a href="#">40.16 Set 1 setpoint 1 source</a> .  | <i>Not selected</i>                          |  |                        |   |   |                                 |   |   |                                 |   |   |                                 |   |   |                                 |                     |
| <a href="#">40.18</a>                        | <a href="#">Set 1 setpoint function</a>      | Selects a mathematical function between the setpoint sources selected by parameters <a href="#">40.16 Set 1 setpoint 1 source</a> and <a href="#">40.17 Set 1 setpoint 2 source</a> .  | <i>In1 or In2</i>                            |  |                        |   |   |                                 |   |   |                                 |   |   |                                 |   |   |                                 |                     |
|  | In1 or In2                                   | No mathematical function applied. The source selected by parameter <a href="#">40.25 Set 1 setpoint selection</a> is used.   | 0  |  |                        |   |   |                                 |   |   |                                 |   |   |                                 |   |   |                                 |                     |
|  | In1+In2                                      | Sum of sources 1 and 2.  | 1  |  |                        |   |   |                                 |   |   |                                 |   |   |                                 |   |   |                                 |                     |
|  | In1-In2                                      | Source 2 subtracted from source 1.   | 2  |  |                        |   |   |                                 |   |   |                                 |   |   |                                 |   |   |                                 |                     |
|  | In1*In2                                      | Source 1 multiplied by source 2.   | 3  |  |                        |   |   |                                 |   |   |                                 |   |   |                                 |   |   |                                 |                     |
|  | In1/In2                                      | Source 1 divided by source 2.  | 4  |  |                        |   |   |                                 |   |   |                                 |   |   |                                 |   |   |                                 |                     |
|  | MIN(In1,In2)                                 | Smaller of the two sources.  | 5  |  |                        |   |   |                                 |   |   |                                 |   |   |                                 |   |   |                                 |                     |
|  | MAX(In1,In2)                                 | Greater of the two sources.  | 6  |  |                        |   |   |                                 |   |   |                                 |   |   |                                 |   |   |                                 |                     |
|  | AVE(In1,In2)                                 | Average of the two sources.  | 7  |  |                        |   |   |                                 |   |   |                                 |   |   |                                 |   |   |                                 |                     |
|  | sqrt(In1)                                    | Square root of source 1.   | 8  |  |                        |   |   |                                 |   |   |                                 |   |   |                                 |   |   |                                 |                     |
|  | sqrt(In1-In2)                                | Square root of (source 1 - source 2).  | 9  |  |                        |   |   |                                 |   |   |                                 |   |   |                                 |   |   |                                 |                     |
|  | sqrt(In1+In2)                                | Square root of (source 1 + source 2).  | 10   |  |                        |   |   |                                 |   |   |                                 |   |   |                                 |   |   |                                 |                     |
|  | sqrt(In1)+sqrt(In2)                          | Square root of source 1 + square root of source 2.   | 11   |  |                        |   |   |                                 |   |   |                                 |   |   |                                 |   |   |                                 |                     |
| <a href="#">40.19</a>                        | <a href="#">Set 1 internal setpoint sel1</a> | Selects, together with <a href="#">40.20 Set 1 internal setpoint sel2</a> , the internal setpoint out of the presets defined by parameters <a href="#">40.21...40.24</a> . <table border="1" data-bbox="478 1682 1188 1921"> <thead> <tr> <th>Source defined by par. <a href="#">40.19</a></th> <th>Source defined by par. <a href="#">40.20</a></th> <th>Setpoint preset active</th> </tr> </thead> <tbody> <tr> <td>0</td> <td>0</td> <td>1 (par. <a href="#">40.21</a>)</td> </tr> <tr> <td>1</td> <td>0</td> <td>2 (par. <a href="#">40.22</a>)</td> </tr> <tr> <td>0</td> <td>1</td> <td>3 (par. <a href="#">40.23</a>)</td> </tr> <tr> <td>1</td> <td>1</td> <td>4 (par. <a href="#">40.24</a>)</td> </tr> </tbody> </table> | Source defined by par. <a href="#">40.19</a> | Source defined by par. <a href="#">40.20</a> | Setpoint preset active | 0 | 0 | 1 (par. <a href="#">40.21</a> ) | 1 | 0 | 2 (par. <a href="#">40.22</a> ) | 0 | 1 | 3 (par. <a href="#">40.23</a> ) | 1 | 1 | 4 (par. <a href="#">40.24</a> ) | <i>Not selected</i> |
| Source defined by par. <a href="#">40.19</a> | Source defined by par. <a href="#">40.20</a> | Setpoint preset active   |  |  |                        |   |   |                                 |   |   |                                 |   |   |                                 |   |   |                                 |                     |
| 0  | 0  | 1 (par. <a href="#">40.21</a> )  |  |  |                        |   |   |                                 |   |   |                                 |   |   |                                 |   |   |                                 |                     |
| 1  | 0  | 2 (par. <a href="#">40.22</a> )  |  |  |                        |   |   |                                 |   |   |                                 |   |   |                                 |   |   |                                 |                     |
| 0  | 1  | 3 (par. <a href="#">40.23</a> )  |  |  |                        |   |   |                                 |   |   |                                 |   |   |                                 |   |   |                                 |                     |
| 1  | 1  | 4 (par. <a href="#">40.24</a> )  |  |  |                        |   |   |                                 |   |   |                                 |   |   |                                 |   |   |                                 |                     |
|  | Not selected                                 | 0.   | 0  |  |                        |   |   |                                 |   |   |                                 |   |   |                                 |   |   |                                 |                     |
|  | Selected                                     | 1.   | 1  |  |                        |   |   |                                 |   |   |                                 |   |   |                                 |   |   |                                 |                     |
|  | DI1  | Digital input DI1 ( <a href="#">10.02 DI delayed status</a> , bit 0).  | 2  |  |                        |   |   |                                 |   |   |                                 |   |   |                                 |   |   |                                 |                     |



| No.                   | Name/Value                                   | Description  | Def/FbEq16          |
|-----------------------|--|--|---------------------|
|                       | DI2  | Digital input DI2 ( <a href="#">10.02 DI delayed status</a> , bit 1).  | 3                   |
|                       | DI3  | Digital input DI3 ( <a href="#">10.02 DI delayed status</a> , bit 2).  | 4                   |
|                       | DI4  | Digital input DI4 ( <a href="#">10.02 DI delayed status</a> , bit 3).  | 5                   |
|                       | DI5  | Digital input DI5 ( <a href="#">10.02 DI delayed status</a> , bit 4).  | 6                   |
|                       | DI6  | Digital input DI6 ( <a href="#">10.02 DI delayed status</a> , bit 5).  | 7                   |
|                       | DIO1   | Digital input/output DIO1 ( <a href="#">11.02 DIO delayed status</a> , bit 0).   | 10                  |
|                       | DIO2   | Digital input/output DIO2 ( <a href="#">11.02 DIO delayed status</a> , bit 1).   | 11                  |
|                       | <i>Other [bit]</i>                           | Source selection (see <a href="#">Terms and abbreviations</a> on page 112).  | -                   |
| <a href="#">40.20</a> | <a href="#">Set 1 internal setpoint sel2</a> | Selects, together with <a href="#">40.19 Set 1 internal setpoint sel1</a> , the internal setpoint out of the presets defined by parameters <a href="#">40.21...40.24</a> . See table at <a href="#">40.19 Set 1 internal setpoint sel1</a> . | <i>Not selected</i> |
|                       | Not selected                                 | 0.   | 0                   |
|                       | Selected                                     | 1.   | 1                   |
|                       | DI1  | Digital input DI1 ( <a href="#">10.02 DI delayed status</a> , bit 0).  | 2                   |
|                       | DI2  | Digital input DI2 ( <a href="#">10.02 DI delayed status</a> , bit 1).  | 3                   |
|                       | DI3  | Digital input DI3 ( <a href="#">10.02 DI delayed status</a> , bit 2).  | 4                   |
|                       | DI4  | Digital input DI4 ( <a href="#">10.02 DI delayed status</a> , bit 3).  | 5                   |
|                       | DI5  | Digital input DI5 ( <a href="#">10.02 DI delayed status</a> , bit 4).  | 6                   |
|                       | DI6  | Digital input DI6 ( <a href="#">10.02 DI delayed status</a> , bit 5).  | 7                   |
|                       | DIO1   | Digital input/output DIO1 ( <a href="#">11.02 DIO delayed status</a> , bit 0).   | 10                  |
|                       | DIO2   | Digital input/output DIO2 ( <a href="#">11.02 DIO delayed status</a> , bit 1).   | 11                  |
|                       | <i>Other [bit]</i>                           | Source selection (see <a href="#">Terms and abbreviations</a> on page 112).  | -                   |
| <a href="#">40.21</a> | <a href="#">Set 1 internal setpoint 1</a>    | Defines process setpoint preset 1. See parameter <a href="#">40.19 Set 1 internal setpoint sel1</a> .<br>The unit is selected by parameter <a href="#">40.12 Set 1 unit selection</a> .  | 0.00                |
|                       | -32768.00 ...<br>32767.00                    | Process setpoint preset 1.   | 1 = 1 unit          |
| <a href="#">40.22</a> | <a href="#">Set 1 internal setpoint 2</a>    | Defines process setpoint preset 2. See parameter <a href="#">40.19 Set 1 internal setpoint sel1</a> .<br>The unit is selected by parameter <a href="#">40.12 Set 1 unit selection</a> .  | 0.00                |
|                       | -32768.00 ...<br>32767.00                    | Process setpoint preset 2.   | 1 = 1 unit          |
| <a href="#">40.23</a> | <a href="#">Set 1 internal setpoint 3</a>    | Defines process setpoint preset 3. See parameter <a href="#">40.19 Set 1 internal setpoint sel1</a> .<br>The unit is selected by parameter <a href="#">40.12 Set 1 unit selection</a> .  | 0.00                |
|                       | -32768.00 ...<br>32767.00                    | Process setpoint preset 3.   | 1 = 1 unit          |
| <a href="#">40.24</a> | <a href="#">Set 1 internal setpoint 4</a>    | Defines process setpoint preset 4. See parameter <a href="#">40.19 Set 1 internal setpoint sel1</a> .<br>The unit is selected by parameter <a href="#">40.12 Set 1 unit selection</a> .  | 0.00                |
|                       | -32768.00 ...<br>32767.00                    | Process setpoint preset 4.   | 1 = 1 unit          |

| No.   | Name/Value                          | Description   | Def/FbEq16               |
|-------|-------------------------------------|---|--------------------------|
| 40.25 | <i>Set 1 setpoint selection</i>     | Configures the selection between setpoint sources 1 (40.16) and 2 (40.17).<br>This parameter is only effective when parameter 40.18 <i>Set 1 setpoint function</i> is set to <i>In1</i> or <i>In2</i> .<br>0 = Setpoint source 1<br>1 = Setpoint source 2   | <i>Setpoint source 1</i> |
|       | Setpoint source 1                   | 0.  | 0                        |
|       | Setpoint source 2                   | 1.  | 1                        |
|       | DI1                                 | Digital input DI1 (10.02 <i>DI delayed status</i> , bit 0).   | 2                        |
|       | DI2                                 | Digital input DI2 (10.02 <i>DI delayed status</i> , bit 1).   | 3                        |
|       | DI3                                 | Digital input DI3 (10.02 <i>DI delayed status</i> , bit 2).   | 4                        |
|       | DI4                                 | Digital input DI4 (10.02 <i>DI delayed status</i> , bit 3).   | 5                        |
|       | DI5                                 | Digital input DI5 (10.02 <i>DI delayed status</i> , bit 4).   | 6                        |
|       | DI6                                 | Digital input DI6 (10.02 <i>DI delayed status</i> , bit 5).   | 7                        |
|       | DIO1                                | Digital input/output DIO1 (11.02 <i>DIO delayed status</i> , bit 0).  | 10                       |
|       | DIO2                                | Digital input/output DIO2 (11.02 <i>DIO delayed status</i> , bit 1).  | 11                       |
|       | <i>Other [bit]</i>                  | Source selection (see <i>Terms and abbreviations</i> on page 112).  | -                        |
| 40.26 | <i>Set 1 setpoint min</i>           | Defines a minimum limit for the process PID controller setpoint.  | 0.00                     |
|       | -32768.00 ...<br>32767.00           | Minimum limit for process PID controller setpoint.  | 1 = 1                    |
| 40.27 | <i>Set 1 setpoint max</i>           | Defines a maximum limit for the process PID controller setpoint.  | 32767.00                 |
|       | -32768.00 ...<br>32767.00           | Maximum limit for process PID controller setpoint.  | 1 = 1                    |
| 40.28 | <i>Set 1 setpoint increase time</i> | Defines the minimum time it takes for the setpoint to increase from 0% to 100%.   | 0.0 s                    |
|       | 0.0 ... 1800.0 s                    | Setpoint increase time.   | 1 = 1                    |
| 40.29 | <i>Set 1 setpoint decrease time</i> | Defines the minimum time it takes for the setpoint to decrease from 100% to 0%.   | 0.0 s                    |
|       | 0.0 ... 1800.0 s                    | Setpoint decrease time.   | 1 = 1                    |
| 40.30 | <i>Set 1 setpoint freeze enable</i> | Freezes, or defines a source that can be used to freeze, the setpoint of the process PID controller. This feature is useful when the reference is based on a process feedback connected to an analog input, and the sensor must be serviced without stopping the process.<br>1 = Process PID controller setpoint frozen<br>See also parameter 40.38 <i>Set 1 output freeze enable</i> . | <i>Not selected</i>      |
|       | Not selected                        | Process PID controller setpoint not frozen.   | 0                        |
|       | Selected                            | Process PID controller setpoint frozen.   | 1                        |
|       | DI1                                 | Digital input DI1 (10.02 <i>DI delayed status</i> , bit 0).   | 2                        |
|       | DI2                                 | Digital input DI2 (10.02 <i>DI delayed status</i> , bit 1).   | 3                        |
|       | DI3                                 | Digital input DI3 (10.02 <i>DI delayed status</i> , bit 2).   | 4                        |
|       | DI4                                 | Digital input DI4 (10.02 <i>DI delayed status</i> , bit 3).   | 5                        |
|       | DI5                                 | Digital input DI5 (10.02 <i>DI delayed status</i> , bit 4).   | 6                        |
|       | DI6                                 | Digital input DI6 (10.02 <i>DI delayed status</i> , bit 5).   | 7                        |

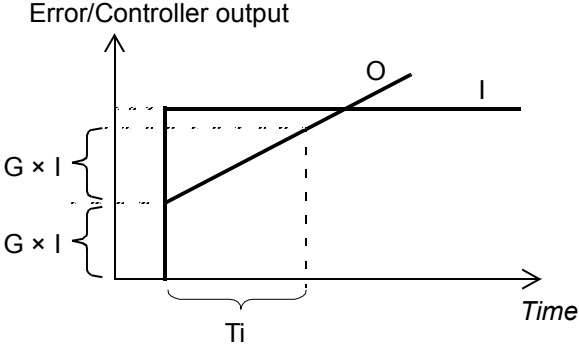
| No.   | Name/Value                       | Description  | Def/FbEq16                      |
|-------|----------------------------------|--|---------------------------------|
|       | DIO1                             | Digital input/output DIO1 ( <i>11.02 DIO delayed status</i> , bit 0).  | 10                              |
|       | DIO2                             | Digital input/output DIO2 ( <i>11.02 DIO delayed status</i> , bit 1).  | 11                              |
|       | <i>Other [bit]</i>               | Source selection (see <i>Terms and abbreviations</i> on page 112).   | -                               |
| 40.31 | <i>Set 1 deviation inversion</i> | Inverts the input of the process PID controller.<br>0 = Deviation not inverted (Deviation = Setpoint - Feedback)<br>1 = Deviation inverted (Deviation = Feedback - Setpoint)<br>See also section <i>Sleep function for process PID control</i> (page 67).  | <i>Not inverted (Ref - Fbk)</i> |
|       | Not inverted (Ref - Fbk)         | 0.   | 0                               |
|       | Inverted (Fbk - Ref)             | 1.   | 1                               |
|       | <i>Other [bit]</i>               | Source selection (see <i>Terms and abbreviations</i> on page 112).   | -                               |
| 40.32 | <i>Set 1 gain</i>                | Defines the gain for the process PID controller. See parameter <i>40.33 Set 1 integration time</i> .   | 1.00                            |
|       | 0.10 ... 100.00                  | Gain for PID controller.   | 100 = 1                         |
| 40.33 | <i>Set 1 integration time</i>    | Defines the integration time for the process PID controller. This time needs to be set to the same order of magnitude as the reaction time of the process being controlled, otherwise instability will result.<br><br> <p>I = controller input (error)<br/>O = controller output<br/>G = gain<br/>Ti = integration time</p> <p><b>Note:</b> Setting this value to 0 disables the “I” part, turning the PID controller into a PD controller.</p> | 60.0 s                          |
|       | 0.0 ... 32767.0 s                | Integration time.  | 1 = 1 s                         |
| 40.34 | <i>Set 1 derivation time</i>     | Defines the derivation time of the process PID controller. The derivative component at the controller output is calculated on basis of two consecutive error values ( $E_{K-1}$ and $E_K$ ) according to the following formula:<br>PID DERIV TIME $\times (E_K - E_{K-1})/T_S$ , in which<br>$T_S = 2$ ms sample time<br>E = Error = Process reference - process feedback.   | 0.000 s                         |
|       | 0.000 ... 10.000 s               | Derivation time.   | 1000 = 1 s                      |

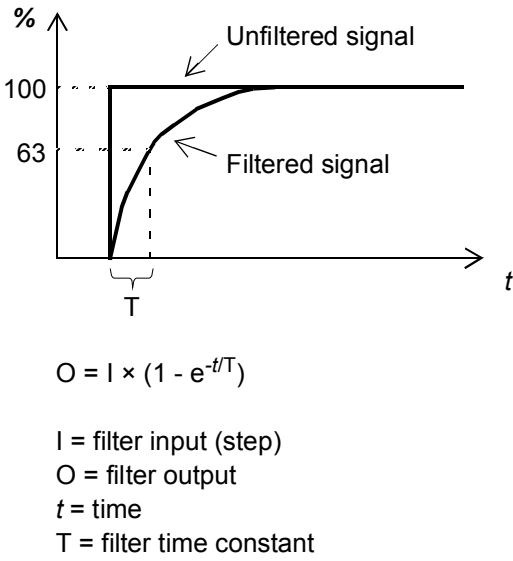
| No.   | Name/Value                          | Description   | Def/FbEq16                      |
|-------|-------------------------------------|---|---------------------------------|
| 40.35 | <i>Set 1 derivation filter time</i> | <p>Defines the time constant of the 1-pole filter used to smooth the derivative component of the process PID controller.</p>  <p><math>O = I \times (1 - e^{-t/T})</math></p> <p>I = filter input (step)<br/> O = filter output<br/> t = time<br/> T = filter time constant</p>   | 0.0 s                           |
|       | 0.0 ... 10.0 s                      | Filter time constant.   | 10 = 1 s                        |
| 40.36 | <i>Set 1 output min</i>             | Defines the minimum limit for the process PID controller output. Using the minimum and maximum limits, it is possible to restrict the operation range.  | 0.0                             |
|       | -32768.0 ... 32767.0                | Minimum limit for process PID controller output.  | 1 = 1                           |
| 40.37 | <i>Set 1 output max</i>             | Defines the maximum limit for the process PID controller output. See parameter <a href="#">40.36 Set 1 output min</a> .   | 1500.0;<br>1800.0<br>(95.20 b0) |
|       | -32768.0 ... 32767.0                | Maximum limit for process PID controller output.  | 1 = 1                           |
| 40.38 | <i>Set 1 output freeze enable</i>   | <p>Freezes (or defines a source that can be used to freeze) the output of the process PID controller, keeping the output at the value it was before freeze was enabled. This feature can be used when, for example, a sensor providing process feedback must to be serviced without stopping the process.</p> <p>1 = Process PID controller output frozen</p> <p>See also parameter <a href="#">40.30 Set 1 setpoint freeze enable</a>.</p> | <i>Not selected</i>             |
|       | Not selected                        | Process PID controller output not frozen.   | 0                               |
|       | Selected                            | Process PID controller output frozen.   | 1                               |
|       | DI1                                 | Digital input DI1 ( <a href="#">10.02 DI delayed status</a> , bit 0).   | 2                               |
|       | DI2                                 | Digital input DI2 ( <a href="#">10.02 DI delayed status</a> , bit 1).   | 3                               |
|       | DI3                                 | Digital input DI3 ( <a href="#">10.02 DI delayed status</a> , bit 2).   | 4                               |
|       | DI4                                 | Digital input DI4 ( <a href="#">10.02 DI delayed status</a> , bit 3).   | 5                               |
|       | DI5                                 | Digital input DI5 ( <a href="#">10.02 DI delayed status</a> , bit 4).   | 6                               |
|       | DI6                                 | Digital input DI6 ( <a href="#">10.02 DI delayed status</a> , bit 5).   | 7                               |
|       | DIO1                                | Digital input/output DIO1 ( <a href="#">11.02 DIO delayed status</a> , bit 0).  | 10                              |
|       | DIO2                                | Digital input/output DIO2 ( <a href="#">11.02 DIO delayed status</a> , bit 1).  | 11                              |
|       | <i>Other [bit]</i>                  | Source selection (see <a href="#">Terms and abbreviations</a> on page 112).   | -                               |

| No.   | Name/Value                           | Description  | Def/FbEq16          |
|-------|--------------------------------------|--|---------------------|
| 40.39 | <a href="#">Set 1 deadband range</a> | Defines a deadband around the setpoint. Whenever process feedback enters the deadband, a delay timer starts. If the feedback remains within the deadband longer than the delay ( <a href="#">40.40 Set 1 deadband delay</a> ), the PID controller output is frozen. Normal operation resumes after the feedback value leaves the deadband. | 0.0                 |
|       |                                      |  |                     |
|       | 0.0 ... 32767.0                      | Deadband range.  | 1 = 1               |
| 40.40 | <a href="#">Set 1 deadband delay</a> | Delay for the deadband. See parameter <a href="#">40.39 Set 1 deadband range</a> .   | 0.0 s               |
|       | 0.0 ... 3600.0 s                     | Delay for deadband area.   | 1 = 1 s             |
| 40.41 | <a href="#">Set 1 sleep mode</a>     | Selects the mode of the sleep function. See also section <a href="#">Sleep function for process PID control</a> (page 67).   | <i>Not selected</i> |
|       | Not selected                         | Sleep function disabled.   | 0                   |
|       | Internal                             | The output of the PID controller is compared to the value of <a href="#">40.43 Set 1 sleep level</a> . If the PID controller output remains below the sleep level longer than the sleep delay ( <a href="#">40.44 Set 1 sleep delay</a> ), the drive enters sleep mode. Parameters <a href="#">40.44...40.48</a> are in force.             | 1                   |
|       | External                             | The sleep function is activated by the source selected by parameter <a href="#">40.42 Set 1 sleep enable</a> . Parameters <a href="#">40.44...40.46</a> and <a href="#">40.48</a> are in force.  | 2                   |
| 40.42 | <a href="#">Set 1 sleep enable</a>   | Defines a source that is used to activate the PID sleep function when parameter <a href="#">40.41 Set 1 sleep mode</a> is set to <i>External</i> .<br>0 = Sleep function disabled<br>1 = Sleep function activated  | <i>Not selected</i> |
|       | Not selected                         | 0.   | 0                   |
|       | Selected                             | 1.   | 1                   |
|       | DI1                                  | Digital input DI1 ( <a href="#">10.02 DI delayed status</a> , bit 0).  | 2                   |
|       | DI2                                  | Digital input DI2 ( <a href="#">10.02 DI delayed status</a> , bit 1).  | 3                   |
|       | DI3                                  | Digital input DI3 ( <a href="#">10.02 DI delayed status</a> , bit 2).  | 4                   |

## 310 Parameters

| No.   | Name/Value                          | Description   | Def/FbEq16          |
|-------|-------------------------------------|---|---------------------|
|       | DI4                                 | Digital input DI4 ( <i>10.02 DI delayed status</i> , bit 3).  | 5                   |
|       | DI5                                 | Digital input DI5 ( <i>10.02 DI delayed status</i> , bit 4).  | 6                   |
|       | DI6                                 | Digital input DI6 ( <i>10.02 DI delayed status</i> , bit 5).  | 7                   |
|       | DIO1                                | Digital input/output DIO1 ( <i>11.02 DIO delayed status</i> , bit 0).   | 10                  |
|       | DIO2                                | Digital input/output DIO2 ( <i>11.02 DIO delayed status</i> , bit 1).   | 11                  |
|       | <i>Other [bit]</i>                  | Source selection (see <i>Terms and abbreviations</i> on page 112).  | -                   |
| 40.43 | <i>Set 1 sleep level</i>            | Defines the start limit for the sleep function when parameter <i>40.41 Set 1 sleep mode</i> is set to <i>Internal</i> .   | 0.0                 |
|       | 0.0 ... 32767.0                     | Sleep start level.  | 1 = 1               |
| 40.44 | <i>Set 1 sleep delay</i>            | Defines a delay before the sleep function actually becomes enabled, to prevent nuisance sleeping.<br>The delay timer starts when the sleep condition selected by parameter <i>40.41 Set 1 sleep mode</i> becomes true, and resets if the condition becomes false.   | 60.0 s              |
|       | 0.0 ... 3600.0 s                    | Sleep start delay.  | 1 = 1 s             |
| 40.45 | <i>Set 1 sleep boost time</i>       | Defines a boost time for the sleep boost step. See parameter <i>40.46 Set 1 sleep boost step</i> .  | 0.0 s               |
|       | 0.0 ... 3600.0 s                    | Sleep boost time.   | 1 = 1 s             |
| 40.46 | <i>Set 1 sleep boost step</i>       | When the drive is entering sleep mode, the process setpoint is increased by this value for the time defined by parameter <i>40.45 Set 1 sleep boost time</i> .<br>If active, sleep boost is aborted when the drive wakes up.  | 0.0                 |
|       | 0.0 ... 32767.0                     | Sleep boost step.   | 1 = 1               |
| 40.47 | <i>Set 1 wake-up deviation</i>      | When <i>40.41 Set 1 sleep mode</i> is set to <i>Internal</i> , this parameter defines the wake-up level as deviation between process setpoint and feedback. The unit is selected by parameter <i>40.12 Set 1 unit selection</i> .<br>When the deviation exceeds the value of this parameter, and remains there for the duration of the wake-up delay ( <i>40.48 Set 1 wake-up delay</i> ), the drive wakes up.<br>See also parameter <i>40.31 Set 1 deviation inversion</i> . | 0.00 rpm, % or Hz   |
|       | -32768.00 ... 32767.00 rpm, % or Hz | Wake-up level (as deviation between process setpoint and feedback).   | 1 = 1 unit          |
| 40.48 | <i>Set 1 wake-up delay</i>          | Defines a wake-up delay for the sleep function to prevent nuisance wake-ups. See parameter <i>40.47 Set 1 wake-up deviation</i> .<br>The delay timer starts when the deviation exceeds the wake-up level ( <i>40.47 Set 1 wake-up deviation</i> ), and resets if the deviation falls below the wake-up level.   | 0.50 s              |
|       | 0.00 ... 60.00 s                    | Wake-up delay.  | 1 = 1 s             |
| 40.49 | <i>Set 1 tracking mode</i>          | Activates (or selects a source that activates) tracking mode. In tracking mode, the value selected by parameter <i>40.50 Set 1 tracking ref selection</i> is substituted for the PID controller output. See also section <i>Tracking</i> (page 68).<br>1 = Tracking mode enabled  | <i>Not selected</i> |
|       | Not selected                        | 0.  | 0                   |
|       | Selected                            | 1.  | 1                   |
|       | DI1                                 | Digital input DI1 ( <i>10.02 DI delayed status</i> , bit 0).  | 2                   |
|       | DI2                                 | Digital input DI2 ( <i>10.02 DI delayed status</i> , bit 1).  | 3                   |

| No.                   | Name/Value                                   | Description   | Def/FbEq16          |
|-----------------------|--|---|---------------------|
|                       | DI3  | Digital input DI3 ( <a href="#">10.02 DI delayed status</a> , bit 2).   | 4                   |
|                       | DI4  | Digital input DI4 ( <a href="#">10.02 DI delayed status</a> , bit 3).   | 5                   |
|                       | DI5  | Digital input DI5 ( <a href="#">10.02 DI delayed status</a> , bit 4).   | 6                   |
|                       | DI6  | Digital input DI6 ( <a href="#">10.02 DI delayed status</a> , bit 5).   | 7                   |
|                       | DIO1   | Digital input/output DIO1 ( <a href="#">11.02 DIO delayed status</a> , bit 0).  | 10                  |
|                       | DIO2   | Digital input/output DIO2 ( <a href="#">11.02 DIO delayed status</a> , bit 1).  | 11                  |
|                       | <i>Other [bit]</i>                           | Source selection (see <a href="#">Terms and abbreviations</a> on page 112).   | -                   |
| <a href="#">40.50</a> | <a href="#">Set 1 tracking ref selection</a> | Selects the value source for tracking mode. See parameter <a href="#">40.49 Set 1 tracking mode</a> .   | <i>Not selected</i> |
|                       | Not selected                                 | None.   | 0                   |
|                       | AI1 scaled                                   | <a href="#">12.12 AI1 scaled value</a> (see page 158).  | 1                   |
|                       | AI2 scaled                                   | <a href="#">12.22 AI2 scaled value</a> (see page 160).  | 2                   |
|                       | FB A ref1                                    | <a href="#">03.05 FB A reference 1</a> (see page 119).  | 3                   |
|                       | FB A ref2                                    | <a href="#">03.06 FB A reference 2</a> (see page 120).  | 4                   |
|                       | <i>Other</i>                                 | Source selection (see <a href="#">Terms and abbreviations</a> on page 112).   | -                   |
| <a href="#">40.51</a> | <a href="#">Set 1 trim mode</a>              | Activates the trim function and selects between direct and proportional trimming (or a combination of both). With trimming, it is possible to apply a corrective factor to the drive reference (setpoint). The output after trimming is available as parameter <a href="#">40.05 Process PID trim output act</a> . See the control chain diagram on page 579. | <i>Off</i>          |
|                       | Off  | The trim function is inactive.  | 0                   |
|                       | Direct                                       | The trim function is active. The trimming factor is relative to the maximum speed, torque or frequency; the selection between these is made by parameter <a href="#">40.52 Set 1 trim selection</a> .   | 1                   |
|                       | Proportional                                 | The trim function is active. The trimming factor is relative to the reference selected by parameter <a href="#">40.53 Set 1 trimmed ref pointer</a> .   | 2                   |
|                       | Combined                                     | The trim function is active. The trimming factor is a combination of both <i>Direct</i> and <i>Proportional</i> modes; the proportions of each are defined by parameter <a href="#">40.54 Set 1 trim mix</a> .  | 3                   |
| <a href="#">40.52</a> | <a href="#">Set 1 trim selection</a>         | Selects whether trimming is used for correcting the speed, torque or frequency reference.   | <i>Torque</i>       |
|                       | Torque                                       | Torque reference trimming.  | 1                   |
|                       | Speed  | Speed reference trimming.   | 2                   |
|                       | Frequency                                    | Frequency reference trimming.   | 3                   |
| <a href="#">40.53</a> | <a href="#">Set 1 trimmed ref pointer</a>    | Selects the signal source for the trim reference.   | <i>Not selected</i> |
|                       | Not selected                                 | None.   | 0                   |
|                       | AI1 scaled                                   | <a href="#">12.12 AI1 scaled value</a> (see page 158).  | 1                   |
|                       | AI2 scaled                                   | <a href="#">12.22 AI2 scaled value</a> (see page 160).  | 2                   |
|                       | FB A ref1                                    | <a href="#">03.05 FB A reference 1</a> (see page 119).  | 3                   |
|                       | FB A ref2                                    | <a href="#">03.06 FB A reference 2</a> (see page 120).  | 4                   |
|                       | <i>Other</i>                                 | Source selection (see <a href="#">Terms and abbreviations</a> on page 112).   | -                   |



## 312 Parameters

| No.   | Name/Value                         | Description  | Def/FbEq16          |
|-------|------------------------------------|--|---------------------|
| 40.54 | <i>Set 1 trim mix</i>              | When parameter <i>40.51 Set 1 trim mode</i> is set to <i>Combined</i> , defines the effect of direct and proportional trim sources in the final trimming factor.<br>0.000 = 100% proportional<br>0.500 = 50% proportional, 50% direct<br>1.000 = 100% direct | 0.000               |
|       | 0.000 ... 1.000                    | Trim mix.  | 1 = 1               |
| 40.55 | <i>Set 1 trim adjust</i>           | Defines a multiplier for the trimming factor. This value is multiplied by the result of parameter <i>40.51 Set 1 trim mode</i> . Consequently, the result of the multiplication is used to multiply the result of parameter <i>40.56 Set 1 trim source</i> . | 1.000               |
|       | -100.000 ...<br>100.000            | Multiplier for trimming factor.  | 1 = 1               |
| 40.56 | <i>Set 1 trim source</i>           | Selects the reference to be trimmed.   | <i>PID ref</i>      |
|       | PID ref                            | PID setpoint.  | 1                   |
|       | PID output                         | PID controller output.   | 2                   |
| 40.57 | <i>PID set1/set2 selection</i>     | Selects the source that determines whether process PID parameter set 1 (parameters <i>40.07...40.56</i> ) or set 2 (group <i>41 Process PID set 2</i> ) is used.<br>0 = Process PID parameter set 1 in use<br>1 = Process PID parameter set 2 in use         | <i>Not selected</i> |
|       | Not selected                       | 0.   | 0                   |
|       | Selected                           | 1.   | 1                   |
|       | DI1                                | Digital input DI1 ( <i>10.02 DI delayed status</i> , bit 0).   | 2                   |
|       | DI2                                | Digital input DI2 ( <i>10.02 DI delayed status</i> , bit 1).   | 3                   |
|       | DI3                                | Digital input DI3 ( <i>10.02 DI delayed status</i> , bit 2).   | 4                   |
|       | DI4                                | Digital input DI4 ( <i>10.02 DI delayed status</i> , bit 3).   | 5                   |
|       | DI5                                | Digital input DI5 ( <i>10.02 DI delayed status</i> , bit 4).   | 6                   |
|       | DI6                                | Digital input DI6 ( <i>10.02 DI delayed status</i> , bit 5).   | 7                   |
|       | DIO1                               | Digital input/output DIO1 ( <i>11.02 DIO delayed status</i> , bit 0).  | 10                  |
|       | DIO2                               | Digital input/output DIO2 ( <i>11.02 DIO delayed status</i> , bit 1).  | 11                  |
|       | <i>Other [bit]</i>                 | Source selection (see <i>Terms and abbreviations</i> on page 112).   | -                   |
| 40.60 | <i>Set 1 PID activation source</i> | Selects a source that enables/disables process PID control. See also parameter <i>40.07 Set 1 PID operation mode</i> .<br>0 = Process PID control disabled.<br>1 = Process PID control enabled.  | <i>On</i>           |
|       | Off                                | 0.   | 0                   |
|       | On                                 | 1.   | 1                   |
|       | Follow Ext1/Ext2 selection         | Process PID control is disabled when external control location EXT1 is active, and enabled when external control location EXT2 is active.<br>See also parameter <i>19.11 Ext1/Ext2 selection</i> .   | 2                   |
|       | DI1                                | Digital input DI1 ( <i>10.02 DI delayed status</i> , bit 0).   | 3                   |
|       | DI2                                | Digital input DI2 ( <i>10.02 DI delayed status</i> , bit 1).   | 4                   |
|       | DI3                                | Digital input DI3 ( <i>10.02 DI delayed status</i> , bit 2).   | 5                   |
|       | DI4                                | Digital input DI4 ( <i>10.02 DI delayed status</i> , bit 3).   | 6                   |
|       | DI5                                | Digital input DI5 ( <i>10.02 DI delayed status</i> , bit 4).   | 7                   |



| No.                         | Name/Value                               | Description  | Def/FbEq16   |
|-----------------------------|--|--|--|
|                             | DI6                                      | Digital input DI6 ( <a href="#">10.02 DI delayed status</a> , bit 5).  | 8  |
|                             | DIO1                                     | Digital input/output DIO1 ( <a href="#">11.02 DIO delayed status</a> , bit 0).   | 11   |
|                             | DIO2                                     | Digital input/output DIO2 ( <a href="#">11.02 DIO delayed status</a> , bit 1).   | 12   |
|                             | <i>Other [bit]</i>                       | Source selection (see <a href="#">Terms and abbreviations</a> on page 112).  | -  |
| <b>40.91</b>                | <b><i>Feedback data storage</i></b>      | Storage parameter for receiving a process feedback value eg. through the embedded fieldbus interface.<br>The value can be sent to the drive as Modbus I/O data. Set the target selection parameter of that particular data ( <a href="#">58.101...58.124</a> ) to <a href="#">Feedback data storage</a> . In <a href="#">40.08 Set 1 feedback 1 source</a> (or <a href="#">40.09 Set 1 feedback 2 source</a> ), select <a href="#">Feedback data storage</a> . | -  |
|                             | -327.68 ... 327.67                       | Storage parameter for process feedback.  | 100 = 1  |
| <b>40.92</b>                | <b><i>Setpoint data storage</i></b>      | Storage parameter for receiving a process setpoint value eg. through the embedded fieldbus interface.<br>The value can be sent to the drive as Modbus I/O data. Set the target selection parameter of that particular data ( <a href="#">58.101...58.124</a> ) to <a href="#">Setpoint data storage</a> . In <a href="#">40.16 Set 1 setpoint 1 source</a> (or <a href="#">40.17 Set 1 setpoint 2 source</a> ), select <a href="#">Setpoint data storage</a> . | -  |
|                             | -327.68 ... 327.67                       | Storage parameter for process setpoint.  | 100 = 1  |
| <b>41 Process PID set 2</b> |  | A second set of parameter values for process PID control. The selection between this set and first set (parameter group <a href="#">40 Process PID set 1</a> ) is made by parameter <a href="#">40.57 PID set1/set2 selection</a> .<br>See also parameters <a href="#">40.01...40.06</a> , <a href="#">40.91</a> , <a href="#">40.92</a> , and the control chain diagrams on pages <a href="#">578</a> and <a href="#">579</a> .                               |  |
| <b>41.07</b>                | <b><i>Set 2 PID operation mode</i></b>   | See parameter <a href="#">40.07 Set 1 PID operation mode</a> .   | <i>Off</i>   |
| <b>41.08</b>                | <b><i>Set 2 feedback 1 source</i></b>    | See parameter <a href="#">40.08 Set 1 feedback 1 source</a> .  | <i>All scaled</i>                                  |
| <b>41.09</b>                | <b><i>Set 2 feedback 2 source</i></b>    | See parameter <a href="#">40.09 Set 1 feedback 2 source</a> .  | <i>Not selected</i>                                |
| <b>41.10</b>                | <b><i>Set 2 feedback function</i></b>    | See parameter <a href="#">40.10 Set 1 feedback function</a> .  | <i>In1</i>   |
| <b>41.11</b>                | <b><i>Set 2 feedback filter time</i></b> | See parameter <a href="#">40.11 Set 1 feedback filter time</a> .   | 0.000 s  |
| <b>41.12</b>                | <b><i>Set 2 unit selection</i></b>       | Defines the unit for parameters <a href="#">41.21...41.24</a> and <a href="#">41.47</a> .  | %  |
|                             | rpm                                      | rpm.   | 7  |
|                             | %  | %.   | 4  |
|                             | Hz                                       | Hz.  | 3  |
|                             | PID user unit 2                          | User-definable unit 2. The name of the unit can be edited on the control panel by choosing Menu – Settings – Edit texts.   | 249  |
| <b>41.14</b>                | <b><i>Set 2 setpoint scaling</i></b>     | See parameter <a href="#">40.14 Set 1 setpoint scaling</a> .   | 100.00   |
| <b>41.15</b>                | <b><i>Set 2 output scaling</i></b>       | See parameter <a href="#">40.15 Set 1 output scaling</a> .   | 1500.00;<br>1800.00<br>( <a href="#">95.20</a> b0) |
| <b>41.16</b>                | <b><i>Set 2 setpoint 1 source</i></b>    | See parameter <a href="#">40.16 Set 1 setpoint 1 source</a> .  | <i>Internal setpoint</i>                           |

## 314 Parameters

| No.   | Name/Value                   | Description  | Def/FbEq16                      |
|-------|------------------------------|--|---------------------------------|
| 41.17 | Set 2 setpoint 2 source      | See parameter <a href="#">40.17 Set 1 setpoint 2 source</a> .      | Not selected                    |
| 41.18 | Set 2 setpoint function      | See parameter <a href="#">40.18 Set 1 setpoint function</a> .      | In1 or In2                      |
| 41.19 | Set 2 internal setpoint sel1 | See parameter <a href="#">40.19 Set 1 internal setpoint sel1</a> . | Not selected                    |
| 41.20 | Set 2 internal setpoint sel2 | See parameter <a href="#">40.20 Set 1 internal setpoint sel2</a> . | Not selected                    |
| 41.21 | Set 2 internal setpoint 1    | See parameter <a href="#">40.21 Set 1 internal setpoint 1</a> .    | 0.00                            |
| 41.22 | Set 2 internal setpoint 2    | See parameter <a href="#">40.22 Set 1 internal setpoint 2</a> .    | 0.00                            |
| 41.23 | Set 2 internal setpoint 3    | See parameter <a href="#">40.23 Set 1 internal setpoint 3</a> .    | 0.00                            |
| 41.24 | Set 2 internal setpoint 4    | See parameter <a href="#">40.24 Set 1 internal setpoint 4</a> .    | 0.00                            |
| 41.25 | Set 2 setpoint selection     | See parameter <a href="#">40.25 Set 1 setpoint selection</a> .     | Setpoint source 1               |
| 41.26 | Set 2 setpoint min           | See parameter <a href="#">40.26 Set 1 setpoint min</a> .           | 0.00                            |
| 41.27 | Set 2 setpoint max           | See parameter <a href="#">40.27 Set 1 setpoint max</a> .           | 32767.00                        |
| 41.28 | Set 2 setpoint increase time | See parameter <a href="#">40.28 Set 1 setpoint increase time</a> . | 0.0 s                           |
| 41.29 | Set 2 setpoint decrease time | See parameter <a href="#">40.29 Set 1 setpoint decrease time</a> . | 0.0 s                           |
| 41.30 | Set 2 setpoint freeze enable | See parameter <a href="#">40.30 Set 1 setpoint freeze enable</a> . | Not selected                    |
| 41.31 | Set 2 deviation inversion    | See parameter <a href="#">40.31 Set 1 deviation inversion</a> .    | Not inverted (Ref - Fbk)        |
| 41.32 | Set 2 gain                   | See parameter <a href="#">40.32 Set 1 gain</a> .                   | 1.00                            |
| 41.33 | Set 2 integration time       | See parameter <a href="#">40.33 Set 1 integration time</a> .       | 60.0 s                          |
| 41.34 | Set 2 derivation time        | See parameter <a href="#">40.34 Set 1 derivation time</a> .        | 0.000 s                         |
| 41.35 | Set 2 derivation filter time | See parameter <a href="#">40.35 Set 1 derivation filter time</a> . | 0.0 s                           |
| 41.36 | Set 2 output min             | See parameter <a href="#">40.36 Set 1 output min</a> .             | 0.0                             |
| 41.37 | Set 2 output max             | See parameter <a href="#">40.37 Set 1 output max</a> .             | 1500.0;<br>1800.0<br>(95.20 b0) |
| 41.38 | Set 2 output freeze enable   | See parameter <a href="#">40.38 Set 1 output freeze enable</a> .   | Not selected                    |
| 41.39 | Set 2 deadband range         | See parameter <a href="#">40.39 Set 1 deadband range</a> .         | 0.0                             |
| 41.40 | Set 2 deadband delay         | See parameter <a href="#">40.40 Set 1 deadband delay</a> .         | 0.0 s                           |
| 41.41 | Set 2 sleep mode             | See parameter <a href="#">40.41 Set 1 sleep mode</a> .             | Not selected                    |
| 41.42 | Set 2 sleep enable           | See parameter <a href="#">40.42 Set 1 sleep enable</a> .           | Not selected                    |
| 41.43 | Set 2 sleep level            | See parameter <a href="#">40.43 Set 1 sleep level</a> .            | 0.0                             |

| No.   | Name/Value                          | Description  | Def/FbEq16           |
|-------|-------------------------------------|--|----------------------|
| 41.44 | <i>Set 2 sleep delay</i>            | See parameter <a href="#">40.44 Set 1 sleep delay</a> .            | 60.0 s               |
| 41.45 | <i>Set 2 sleep boost time</i>       | See parameter <a href="#">40.45 Set 1 sleep boost time</a> .       | 0.0 s                |
| 41.46 | <i>Set 2 sleep boost step</i>       | See parameter <a href="#">40.46 Set 1 sleep boost step</a> .       | 0.0                  |
| 41.47 | <i>Set 2 wake-up deviation</i>      | See parameter <a href="#">40.47 Set 1 wake-up deviation</a> .      | 0.00 rpm, %<br>or Hz |
| 41.48 | <i>Set 2 wake-up delay</i>          | See parameter <a href="#">40.48 Set 1 wake-up delay</a> .          | 0.50 s               |
| 41.49 | <i>Set 2 tracking mode</i>          | See parameter <a href="#">40.49 Set 1 tracking mode</a> .          | <i>Not selected</i>  |
| 41.50 | <i>Set 2 tracking ref selection</i> | See parameter <a href="#">40.50 Set 1 tracking ref selection</a> . | <i>Not selected</i>  |
| 41.51 | <i>Set 2 trim mode</i>              | See parameter <a href="#">40.51 Set 1 trim mode</a> .              | <i>Off</i>           |
| 41.52 | <i>Set 2 trim selection</i>         | See parameter <a href="#">40.52 Set 1 trim selection</a> .         | <i>Torque</i>        |
| 41.53 | <i>Set 2 trimmed ref pointer</i>    | See parameter <a href="#">40.53 Set 1 trimmed ref pointer</a> .    | <i>Not selected</i>  |
| 41.54 | <i>Set 2 trim mix</i>               | See parameter <a href="#">40.54 Set 1 trim mix</a> .               | 0.000                |
| 41.55 | <i>Set 2 trim adjust</i>            | See parameter <a href="#">40.55 Set 1 trim adjust</a> .            | 1.000                |
| 41.56 | <i>Set 2 trim source</i>            | See parameter <a href="#">40.56 Set 1 trim source</a> .            | <i>PID ref</i>       |
| 41.60 | <i>Set 2 PID activation source</i>  | See parameter <a href="#">40.60 Set 1 PID activation source</a> .  | <i>On</i>            |

|                         |                                     |  |                 |
|-------------------------|-------------------------------------|--|-----------------|
| <b>43 Brake chopper</b> |                                     | Settings for the internal brake chopper.<br>See also section <a href="#">Brake chopper</a> (page 77).  |                 |
| 43.01                   | <i>Braking resistor temperature</i> | Displays the estimated temperature of the brake resistor, or how close the brake resistor is to being too hot.<br>The value is given in percent where 100% is the eventual temperature the resistor would reach when loaded long enough with its rated maximum load capacity ( <a href="#">43.09 Brake resistor Pmax cont</a> ).<br>The temperature calculation is based on the values of parameters <a href="#">43.08</a> , <a href="#">43.09</a> and <a href="#">43.10</a> , and on the assumption that the resistor is installed as instructed by the manufacturer (ie. it cools down as expected).<br>This parameter is read-only. | -               |
|                         | 0.0 ... 120.0%                      | Estimated brake resistor temperature.  | 1 = 1%          |
| 43.06                   | <i>Brake chopper function</i>       | Enables brake chopper control and selects the brake resistor overload protection method (calculation or measurement).<br><b>Note:</b> Before enabling brake chopper control, ensure that <ul style="list-style-type: none"> <li>• a brake resistor is connected,</li> <li>• overvoltage control is switched off (parameter <a href="#">30.30 Overvoltage control</a>), and</li> <li>• the supply voltage range (parameter <a href="#">95.01 Supply voltage</a>) has been selected correctly.</li> </ul>  | <i>Disabled</i> |
|                         | Disabled                            | Brake chopper control disabled.  | 0               |
|                         | Enabled with thermal model          | Brake chopper control enabled with brake resistor protection based on a thermal model. If you select this, you must also specify the values needed by the model, ie. parameters <a href="#">43.08</a> ... <a href="#">43.12</a> . See the resistor data sheet.   | 1               |

| No.                   | Name/Value                                | Description   | Def/FbEq16 |
|-----------------------|---|---|------------|
|                       | Enabled without thermal model             | Brake chopper control enabled without resistor overload protection based on a thermal model. This setting can be used, for example, if the resistor is equipped with a thermal circuit breaker that is wired to stop the drive if the resistor overheats.<br>Before using this setting, ensure that overvoltage control is switched off (parameter <a href="#">30.30 Overvoltage control</a> )  | 2          |
|                       | Overvoltage peak protection               | Brake chopper control enabled in an overvoltage condition. This setting is intended for situations where <ul style="list-style-type: none"> <li>the braking chopper is not needed for runtime operation, ie. to dissipate the inertial energy of the motor,</li> <li>the motor is able to store a considerable amount of magnetic energy in its windings, and</li> <li>the motor might, deliberately or inadvertently, be stopped by coasting.</li> </ul> In such a situation, the motor would potentially discharge enough magnetic energy towards the drive to cause damage. To protect the drive, the brake chopper can be used with a small resistor dimensioned merely to handle the magnetic energy (not the inertial energy) of the motor.<br>With this setting, the brake chopper is activated only whenever the DC voltage exceeds the overvoltage limit. During normal use, the brake chopper is not operating. | 3          |
| <a href="#">43.07</a> | <a href="#">Brake chopper run enable</a>  | Selects the source for quick brake chopper on/off control.<br>0 = Brake chopper IGBT pulses are cut off<br>1 = Normal brake chopper IGBT modulation allowed.<br>This parameter can be used to enable chopper operation only when the supply is missing from a drive with a regenerative supply unit.  | <i>On</i>  |
|                       | Off                                       | 0.  | 0          |
|                       | On  | 1.  | 1          |
|                       | <i>Other [bit]</i>                        | Source selection (see <a href="#">Terms and abbreviations</a> on page 112).   | -          |
| <a href="#">43.08</a> | <a href="#">Brake resistor thermal tc</a> | Defines the thermal time constant for the brake resistor thermal model.   | 0 s        |
|                       | 0 ... 10000 s                             | Brake resistor thermal time constant, ie. the rated time to achieve 63% temperature.  | 1 = 1 s    |
| <a href="#">43.09</a> | <a href="#">Brake resistor Pmax cont</a>  | Defines the maximum continuous load of the brake resistor which will eventually raise the resistor temperature to the maximum allowed value (= continuous heat dissipation capacity of the resistor in kW) but not above it. The value is used in the resistor overload protection based on the thermal model. See parameter <a href="#">43.06 Brake chopper function</a> , and the brake resistor data sheet.  | 0.00 kW    |
|                       | 0.00 ... 10000.00 kW                      | Maximum continuous load of the brake resistor.  | 1 = 1 kW   |
| <a href="#">43.10</a> | <a href="#">Brake resistance</a>          | Defines the resistance value of the brake resistor. The value is used for the brake chopper protection based on the thermal model. See parameter <a href="#">43.06 Brake chopper function</a> .   | 0.0 ohm    |
|                       | 0.0 ... 1000.0 ohm                        | Brake resistor resistance value.  | 1 = 1 ohm  |

| No.   | Name/Value                          | Description   | Def/FbEq16                     |     |      |             |   |              |  |   |                        |   |   |                      |                                     |   |                 |   |   |         |                              |   |        |   |   |         |  |   |      |   |   |         |  |        |          |  |
|---|-------------------------------------|---|--------------------------------|-----|------|-------------|---|--------------|--|---|------------------------|---|---|----------------------|-------------------------------------|---|-----------------|---|---|---------|------------------------------|---|--------|---|---|---------|--|---|------|---|---|---------|--|--------|----------|--|
| 43.11   | <i>Brake resistor fault limit</i>   | Selects the fault limit for the brake resistor protection based on the thermal model. See parameter <a href="#">43.06 Brake chopper function</a> . When the limit is exceeded, the drive trips on fault <a href="#">7183 BR excess temperature</a> .<br>The value is given in percent of the temperature the resistor reaches when loaded with the power defined by parameter <a href="#">43.09 Brake resistor Pmax cont.</a>       | 105%                           |     |      |             |   |              |  |   |                        |   |   |                      |                                     |   |                 |   |   |         |                              |   |        |   |   |         |  |   |      |   |   |         |  |        |          |  |
|   | 0 ... 150%                          | Brake resistor temperature fault limit.   | 1 = 1%                         |     |      |             |   |              |  |   |                        |   |   |                      |                                     |   |                 |   |   |         |                              |   |        |   |   |         |  |   |      |   |   |         |  |        |          |  |
| 43.12   | <i>Brake resistor warning limit</i> | Selects the warning limit for the brake resistor protection based on the thermal model. See parameter <a href="#">43.06 Brake chopper function</a> . When the limit is exceeded, the drive generates a <a href="#">A793 BR excess temperature</a> warning.<br>The value is given in percent of the temperature the resistor reaches when loaded with the power defined by parameter <a href="#">43.09 Brake resistor Pmax cont.</a> | 95%                            |     |      |             |   |              |  |   |                        |   |   |                      |                                     |   |                 |   |   |         |                              |   |        |   |   |         |  |   |      |   |   |         |  |        |          |  |
|   | 0 ... 150%                          | Brake resistor temperature warning limit.   | 1 = 1%                         |     |      |             |   |              |  |   |                        |   |   |                      |                                     |   |                 |   |   |         |                              |   |        |   |   |         |  |   |      |   |   |         |  |        |          |  |
| <b>44 Mechanical brake control</b>  |                                     | Configuration of mechanical brake control.<br>See also section <a href="#">Mechanical brake control</a> (page 70).  |                                |     |      |             |   |              |  |   |                        |   |   |                      |                                     |   |                 |   |   |         |                              |   |        |   |   |         |  |   |      |   |   |         |  |        |          |  |
| 44.01   | <i>Brake control status</i>         | Displays the mechanical brake control status word.<br>This parameter is read-only.  | -                              |     |      |             |   |              |  |   |                        |   |   |                      |                                     |   |                 |   |   |         |                              |   |        |   |   |         |  |   |      |   |   |         |  |        |          |  |
| <table border="1" style="width: 100%; border-collapse: collapse;"> <thead> <tr> <th style="width: 10%;">Bit</th> <th style="width: 30%;">Name</th> <th style="width: 60%;">Information</th> </tr> </thead> <tbody> <tr> <td>0</td> <td>Open command</td> <td>Close/open command to brake actuator (0 = close, 1 = open).<br/>Connect this bit to desired output.</td> </tr> <tr> <td>1</td> <td>Opening torque request</td> <td>1 = Opening torque requested from drive logic</td> </tr> <tr> <td>2</td> <td>Hold stopped request</td> <td>1 = Hold requested from drive logic</td> </tr> <tr> <td>3</td> <td>Ramp to stopped</td> <td>1 = Ramping down to zero speed requested from drive logic</td> </tr> <tr> <td>4</td> <td>Enabled</td> <td>1 = Brake control is enabled</td> </tr> <tr> <td>5</td> <td>Closed</td> <td>1 = Brake control logic in <a href="#">BRAKE CLOSED</a> state</td> </tr> <tr> <td>6</td> <td>Opening</td> <td>1 = Brake control logic in <a href="#">BRAKE OPENING</a> state</td> </tr> <tr> <td>7</td> <td>Open</td> <td>1 = Brake control logic in <a href="#">BRAKE OPEN</a> state</td> </tr> <tr> <td>8</td> <td>Closing</td> <td>1 = Brake control logic in <a href="#">BRAKE CLOSING</a> state</td> </tr> <tr> <td>9...15</td> <td>Reserved</td> <td></td> </tr> </tbody> </table> |                                     |   |                                | Bit | Name | Information | 0 | Open command | Close/open command to brake actuator (0 = close, 1 = open).<br>Connect this bit to desired output. | 1 | Opening torque request | 1 = Opening torque requested from drive logic | 2 | Hold stopped request | 1 = Hold requested from drive logic | 3 | Ramp to stopped | 1 = Ramping down to zero speed requested from drive logic | 4 | Enabled | 1 = Brake control is enabled | 5 | Closed | 1 = Brake control logic in <a href="#">BRAKE CLOSED</a> state | 6 | Opening | 1 = Brake control logic in <a href="#">BRAKE OPENING</a> state | 7 | Open | 1 = Brake control logic in <a href="#">BRAKE OPEN</a> state | 8 | Closing | 1 = Brake control logic in <a href="#">BRAKE CLOSING</a> state | 9...15 | Reserved |  |
| Bit   | Name                                | Information   |                                |     |      |             |   |              |  |   |                        |   |   |                      |                                     |   |                 |   |   |         |                              |   |        |   |   |         |  |   |      |   |   |         |  |        |          |  |
| 0   | Open command                        | Close/open command to brake actuator (0 = close, 1 = open).<br>Connect this bit to desired output.  |                                |     |      |             |   |              |  |   |                        |   |   |                      |                                     |   |                 |   |   |         |                              |   |        |   |   |         |  |   |      |   |   |         |  |        |          |  |
| 1   | Opening torque request              | 1 = Opening torque requested from drive logic   |                                |     |      |             |   |              |  |   |                        |   |   |                      |                                     |   |                 |   |   |         |                              |   |        |   |   |         |  |   |      |   |   |         |  |        |          |  |
| 2   | Hold stopped request                | 1 = Hold requested from drive logic   |                                |     |      |             |   |              |  |   |                        |   |   |                      |                                     |   |                 |   |   |         |                              |   |        |   |   |         |  |   |      |   |   |         |  |        |          |  |
| 3   | Ramp to stopped                     | 1 = Ramping down to zero speed requested from drive logic   |                                |     |      |             |   |              |  |   |                        |   |   |                      |                                     |   |                 |   |   |         |                              |   |        |   |   |         |  |   |      |   |   |         |  |        |          |  |
| 4   | Enabled                             | 1 = Brake control is enabled  |                                |     |      |             |   |              |  |   |                        |   |   |                      |                                     |   |                 |   |   |         |                              |   |        |   |   |         |  |   |      |   |   |         |  |        |          |  |
| 5   | Closed                              | 1 = Brake control logic in <a href="#">BRAKE CLOSED</a> state   |                                |     |      |             |   |              |  |   |                        |   |   |                      |                                     |   |                 |   |   |         |                              |   |        |   |   |         |  |   |      |   |   |         |  |        |          |  |
| 6   | Opening                             | 1 = Brake control logic in <a href="#">BRAKE OPENING</a> state  |                                |     |      |             |   |              |  |   |                        |   |   |                      |                                     |   |                 |   |   |         |                              |   |        |   |   |         |  |   |      |   |   |         |  |        |          |  |
| 7   | Open                                | 1 = Brake control logic in <a href="#">BRAKE OPEN</a> state   |                                |     |      |             |   |              |  |   |                        |   |   |                      |                                     |   |                 |   |   |         |                              |   |        |   |   |         |  |   |      |   |   |         |  |        |          |  |
| 8   | Closing                             | 1 = Brake control logic in <a href="#">BRAKE CLOSING</a> state  |                                |     |      |             |   |              |  |   |                        |   |   |                      |                                     |   |                 |   |   |         |                              |   |        |   |   |         |  |   |      |   |   |         |  |        |          |  |
| 9...15  | Reserved                            |   |                                |     |      |             |   |              |  |   |                        |   |   |                      |                                     |   |                 |   |   |         |                              |   |        |   |   |         |  |   |      |   |   |         |  |        |          |  |
|   | 0000h...FFFFh                       | Mechanical brake control status word.   | 1 = 1                          |     |      |             |   |              |  |   |                        |   |   |                      |                                     |   |                 |   |   |         |                              |   |        |   |   |         |  |   |      |   |   |         |  |        |          |  |
| 44.02   | <i>Brake torque memory</i>          | Displays the torque (in percent) at the instant of the previous brake close command.<br>This value can be used as a reference for the brake open torque. See parameters <a href="#">44.09 Brake open torque source</a> and <a href="#">44.10 Brake open torque</a> .  | -                              |     |      |             |   |              |  |   |                        |   |   |                      |                                     |   |                 |   |   |         |                              |   |        |   |   |         |  |   |      |   |   |         |  |        |          |  |
|   | -1600.0 ... 1600.0%                 | Torque at brake closure.  | See par. <a href="#">46.03</a> |     |      |             |   |              |  |   |                        |   |   |                      |                                     |   |                 |   |   |         |                              |   |        |   |   |         |  |   |      |   |   |         |  |        |          |  |
| 44.03   | <i>Brake open torque reference</i>  | Displays the currently active brake open torque. See parameters <a href="#">44.09 Brake open torque source</a> and <a href="#">44.10 Brake open torque</a> .<br>This parameter is read-only.  | -                              |     |      |             |   |              |  |   |                        |   |   |                      |                                     |   |                 |   |   |         |                              |   |        |   |   |         |  |   |      |   |   |         |  |        |          |  |
|   | -1600.0 ... 1600.0%                 | Currently active brake open torque.   | See par. <a href="#">46.03</a> |     |      |             |   |              |  |   |                        |   |   |                      |                                     |   |                 |   |   |         |                              |   |        |   |   |         |  |   |      |   |   |         |  |        |          |  |

| No.   | Name/Value                         | Description  | Def/FbEq16            |
|-------|------------------------------------|--|-----------------------|
| 44.06 | <i>Brake control enable</i>        | Activates/deactivates (or selects a source that activates/deactivates) the mechanical brake control logic.<br>0 = Brake control inactive<br>1 = Brake control active   | <i>Not selected</i>   |
|       | Not selected                       | 0.   | 0                     |
|       | Selected                           | 1.   | 1                     |
|       | DI1                                | Digital input DI1 ( <i>10.02 DI delayed status</i> , bit 0).   | 2                     |
|       | DI2                                | Digital input DI2 ( <i>10.02 DI delayed status</i> , bit 1).   | 3                     |
|       | DI3                                | Digital input DI3 ( <i>10.02 DI delayed status</i> , bit 2).   | 4                     |
|       | DI4                                | Digital input DI4 ( <i>10.02 DI delayed status</i> , bit 3).   | 5                     |
|       | DI5                                | Digital input DI5 ( <i>10.02 DI delayed status</i> , bit 4).   | 6                     |
|       | DI6                                | Digital input DI6 ( <i>10.02 DI delayed status</i> , bit 5).   | 7                     |
|       | DIO1                               | Digital input/output DIO1 ( <i>11.02 DIO delayed status</i> , bit 0).  | 10                    |
|       | DIO2                               | Digital input/output DIO2 ( <i>11.02 DIO delayed status</i> , bit 1).  | 11                    |
|       | <i>Other [bit]</i>                 | Source selection (see <i>Terms and abbreviations</i> on page 112).   | -                     |
| 44.07 | <i>Brake acknowledge selection</i> | Activates/deactivates (and selects the source for) brake open/close status (acknowledgement) supervision.<br>When a brake control error (unexpected state of the acknowledgement signal) is detected, the drive reacts as defined by parameter <i>44.17 Brake fault function</i> .<br>0 = Brake closed<br>1 = Brake open   | <i>No acknowledge</i> |
|       | Off                                | 0.   | 0                     |
|       | On                                 | 1.   | 1                     |
|       | No acknowledge                     | Brake open/closed supervision disabled.  | 2                     |
|       | DI1                                | Digital input DI1 ( <i>10.02 DI delayed status</i> , bit 0).   | 3                     |
|       | DI2                                | Digital input DI2 ( <i>10.02 DI delayed status</i> , bit 1).   | 4                     |
|       | DI3                                | Digital input DI3 ( <i>10.02 DI delayed status</i> , bit 2).   | 5                     |
|       | DI4                                | Digital input DI4 ( <i>10.02 DI delayed status</i> , bit 3).   | 6                     |
|       | DI5                                | Digital input DI5 ( <i>10.02 DI delayed status</i> , bit 4).   | 7                     |
|       | DI6                                | Digital input DI6 ( <i>10.02 DI delayed status</i> , bit 5).   | 8                     |
|       | DIO1                               | Digital input/output DIO1 ( <i>11.02 DIO delayed status</i> , bit 0).  | 11                    |
|       | DIO2                               | Digital input/output DIO2 ( <i>11.02 DIO delayed status</i> , bit 1).  | 12                    |
|       | <i>Other [bit]</i>                 | Source selection (see <i>Terms and abbreviations</i> on page 112).   | -                     |
| 44.08 | <i>Brake open delay</i>            | Defines the brake open delay, ie. the delay between the internal open brake command and the release of motor speed control. The delay timer starts when the drive has magnetized the motor and increased the motor torque to the level required for brake release (parameter <i>44.03 Brake open torque reference</i> ). Simultaneously with the timer start, the brake control logic energizes the brake control output and the brake starts to open.<br>Set this parameter to the value of mechanical opening delay specified by the brake manufacturer. | 0.00 s                |
|       | 0.00 ... 5.00 s                    | Brake open delay.  | 100 = 1 s             |

| No.   | Name/Value                      | Description  | Def/FbEq16                     |
|-------|---------------------------------|--|--------------------------------|
| 44.09 | <i>Brake open torque source</i> | Defines a source that is used as a brake opening torque reference if <ul style="list-style-type: none"> <li>its absolute value is greater than the setting of parameter <a href="#">44.10 Brake open torque</a>, and</li> <li>its sign is the same as the setting of <a href="#">44.10 Brake open torque</a>.</li> </ul> See parameter <a href="#">44.10 Brake open torque</a> .   | <i>Brake open torque</i>       |
|       | Zero                            | Zero.  | 0                              |
|       | AI1 scaled                      | <a href="#">12.12 AI1 scaled value</a> (see page 158).   | 1                              |
|       | AI2 scaled                      | <a href="#">12.22 AI2 scaled value</a> (see page 160).   | 2                              |
|       | FBA ref1                        | <a href="#">03.05 FB A reference 1</a> (see page 119).   | 3                              |
|       | FBA ref2                        | <a href="#">03.06 FB A reference 2</a> (see page 120).   | 4                              |
|       | Brake torque memory             | Parameter <a href="#">44.02 Brake torque memory</a> .  | 7                              |
|       | Brake open torque               | Parameter <a href="#">44.10 Brake open torque</a> .  | 8                              |
|       | <i>Other</i>                    | Source selection (see <a href="#">Terms and abbreviations</a> on page 112).  | -                              |
| 44.10 | <i>Brake open torque</i>        | Defines the sign (ie. direction of rotation) and minimum absolute value of the brake open torque (motor torque requested at brake release in percent of motor nominal torque).<br>The value of the source selected by parameter <a href="#">44.09 Brake open torque source</a> is used as the brake open torque only if it has the same sign as this parameter and has a greater absolute value.<br><b>Note:</b> This parameter is not effective in scalar motor control mode. | 0.0%                           |
|       | -1600.0 ... 1600.0%             | Minimum torque at brake release.   | See par. <a href="#">46.03</a> |
| 44.11 | <i>Keep brake closed</i>        | Selects a source that prevents the brake from opening.<br>0 = Normal brake operation<br>1 = Keep brake closed<br><b>Note:</b> This parameter cannot be changed while the drive is running.   | <i>Not selected</i>            |
|       | Not selected                    | 0.   | 0                              |
|       | Selected                        | 1.   | 1                              |
|       | DI1                             | Digital input DI1 ( <a href="#">10.02 DI delayed status</a> , bit 0).  | 2                              |
|       | DI2                             | Digital input DI2 ( <a href="#">10.02 DI delayed status</a> , bit 1).  | 3                              |
|       | DI3                             | Digital input DI3 ( <a href="#">10.02 DI delayed status</a> , bit 2).  | 4                              |
|       | DI4                             | Digital input DI4 ( <a href="#">10.02 DI delayed status</a> , bit 3).  | 5                              |
|       | DI5                             | Digital input DI5 ( <a href="#">10.02 DI delayed status</a> , bit 4).  | 6                              |
|       | DI6                             | Digital input DI6 ( <a href="#">10.02 DI delayed status</a> , bit 5).  | 7                              |
|       | DIO1                            | Digital input/output DIO1 ( <a href="#">11.02 DIO delayed status</a> , bit 0).   | 10                             |
|       | DIO2                            | Digital input/output DIO2 ( <a href="#">11.02 DIO delayed status</a> , bit 1).   | 11                             |
|       | <i>Other [bit]</i>              | Source selection (see <a href="#">Terms and abbreviations</a> on page 112).  | -                              |



| No.   | Name/Value                     | Description  | Def/FbEq16            |
|-------|--------------------------------|--|-----------------------|
| 44.12 | <i>Brake close request</i>     | Selects the source of an external brake close request signal. When on, the signal overrides the internal logic and closes the brake.<br>0 = Normal operation/No external close signal connected<br>1 = Close brake<br><b>Notes:</b><br>• In an open-loop (encoderless) application, if the brake is kept closed by a brake close request against a modulating drive for longer than 5 seconds, the brake is forced to close and the drive trips on a fault, <i>71A5 Mechanical brake opening not allowed</i> .<br>• This parameter cannot be changed while the drive is running. | <i>Not selected</i>   |
|       | Not selected                   | 0.   | 0                     |
|       | Selected                       | 1.   | 1                     |
|       | DI1                            | Digital input DI1 ( <i>10.02 DI delayed status</i> , bit 0).   | 2                     |
|       | DI2                            | Digital input DI2 ( <i>10.02 DI delayed status</i> , bit 1).   | 3                     |
|       | DI3                            | Digital input DI3 ( <i>10.02 DI delayed status</i> , bit 2).   | 4                     |
|       | DI4                            | Digital input DI4 ( <i>10.02 DI delayed status</i> , bit 3).   | 5                     |
|       | DI5                            | Digital input DI5 ( <i>10.02 DI delayed status</i> , bit 4).   | 6                     |
|       | DI6                            | Digital input DI6 ( <i>10.02 DI delayed status</i> , bit 5).   | 7                     |
|       | DIO1                           | Digital input/output DIO1 ( <i>11.02 DIO delayed status</i> , bit 0).  | 10                    |
|       | DIO2                           | Digital input/output DIO2 ( <i>11.02 DIO delayed status</i> , bit 1).  | 11                    |
|       | <i>Other [bit]</i>             | Source selection (see <i>Terms and abbreviations</i> on page 112).   | -                     |
| 44.13 | <i>Brake close delay</i>       | Defines a delay between a close command (that is, when the brake control output is de-energized) and when the drive stops modulating. This is to keep the motor live and under control until the brake actually closes.<br>Set this parameter equal to the value specified by the brake manufacturer as the mechanical make-up time of the brake.  | 0.00 s                |
|       | 0.00 ... 60.00 s               | Brake close delay.   | 100 = 1 s             |
| 44.14 | <i>Brake close level</i>       | Defines the brake close speed as an absolute value. After motor speed remains below this level for the duration of the brake close level delay ( <i>44.15 Brake close level delay</i> ), a close command is given.<br><b>Note:</b> Check the compatibility of this setting with <i>21.03 Stop mode</i> (and the applicable deceleration time).   | 10.00 rpm             |
|       | 0.00 ... 1000.00 rpm           | Brake close speed.   | See par. <i>46.01</i> |
| 44.15 | <i>Brake close level delay</i> | Defines a brake close level delay. See parameter <i>44.14 Brake close level</i> .  | 0.00 s                |
|       | 0.00 ... 10.00 s               | Brake close level delay.   | 100 = 1 s             |
| 44.16 | <i>Brake reopen delay</i>      | Defines a minimum time between brake closure and a subsequent open command.  | 0.00 s                |
|       | 0.00 ... 10.00 s               | Brake reopen delay.  | 100 = 1 s             |



| No.                         | Name/Value                  | Description  | Def/FbEq16   |
|-----------------------------|-----------------------------|--|--------------|
| 44.17                       | <i>Brake fault function</i> | Determines how the drive reacts upon a mechanical brake control error.<br><b>Note:</b> If parameter <i>44.07 Brake acknowledge selection</i> is set to <i>No acknowledge</i> , acknowledgement status supervision is disabled altogether and will generate no warnings or faults. However, the brake open conditions are always supervised.  | <i>Fault</i> |
|                             | Fault                       | The drive trips on a <i>71A2 Mechanical brake closing failed / 71A3 Mechanical brake opening failed</i> fault if the status of the acknowledgement does not match the status presumed by the brake control logic.<br>The drive trips on a <i>71A5 Mechanical brake opening not allowed</i> fault if the brake open conditions cannot be fulfilled (for example, the required motor starting torque is not achieved).   | 0            |
|                             | Warning                     | The drive generates a <i>A7A1 Mechanical brake closing failed / A7A2 Mechanical brake opening failed</i> warning if the status of the acknowledgement does not match the status presumed by the brake control logic.<br>The drive generates a <i>A7A5 Mechanical brake opening not allowed</i> warning if the brake open conditions cannot be fulfilled (for example, the required motor starting torque is not achieved).   | 1            |
|                             | Open fault                  | Upon closing the brake, the drive generates a <i>A7A1 Mechanical brake closing failed</i> warning if the status of the acknowledgement does not match the status presumed by the brake control logic.<br>Upon opening the brake, the drive trips on a <i>71A3 Mechanical brake opening failed</i> fault if the status of the acknowledgement does not match the status presumed by the brake control logic.<br>The drive trips on a <i>71A5 Mechanical brake opening not allowed</i> fault if the brake open conditions cannot be fulfilled (for example, the required motor starting torque is not achieved). | 2            |
| 44.18                       | <i>Brake fault delay</i>    | Defines a close fault delay, ie. time between brake closure and brake close fault trip.  | 0.00 s       |
|                             | 0.00 ... 60.00 s            | Brake close fault delay.   | 100 = 1 s    |
| <b>45 Energy efficiency</b> |                             | Settings for the energy saving calculators.<br>See also section <i>Energy saving calculators</i> (page 88).  |              |
| 45.01                       | <i>Saved GW hours</i>       | Displays the energy saved in GWh compared to direct-on-line motor connection. This parameter is incremented when <i>45.02 Saved MW hours</i> rolls over.<br>This parameter is read-only (see parameter <i>45.21 Energy calculations reset</i> ).   | -            |
|                             | 0...65535 GWh               | Energy savings in GWh.   | 1 = 1 GWh    |
| 45.02                       | <i>Saved MW hours</i>       | Displays the energy saved in MWh compared to direct-on-line motor connection. This parameter is incremented when <i>45.03 Saved kW hours</i> rolls over.<br>When this parameter rolls over, parameter <i>45.01 Saved GW hours</i> is incremented.<br>This parameter is read-only (see parameter <i>45.21 Energy calculations reset</i> ).  | -            |
|                             | 0...999 MWh                 | Energy savings in MWh.   | 1 = 1 MWh    |

## 322 Parameters

| No.   | Name/Value                       | Description  | Def/FbEq16           |
|-------|----------------------------------|--|----------------------|
| 45.03 | <i>Saved kW hours</i>            | Displays the energy saved in kWh compared to direct-on-line motor connection.<br>If the internal brake chopper of the drive is enabled, all energy fed by the motor to the drive is assumed to be converted into heat, but the calculation still records savings made by controlling the speed. If the chopper is disabled, then regenerated energy from the motor is also recorded here.<br>When this parameter rolls over, parameter <a href="#">45.02 Saved MW hours</a> is incremented.<br>This parameter is read-only (see parameter <a href="#">45.21 Energy calculations reset</a> ). | -                    |
|       | 0.0 ... 999.9 kWh                | Energy savings in kWh.   | 10 = 1 kWh           |
| 45.05 | <i>Saved money x1000</i>         | Displays the monetary savings in thousands compared to direct-on-line motor connection. This parameter is incremented when <a href="#">45.06 Saved money</a> rolls over.<br>The currency is defined by parameter <a href="#">45.17 Tariff currency unit</a> .<br>This parameter is read-only (see parameter <a href="#">45.21 Energy calculations reset</a> ).   | -                    |
|       | 0...4294967295 thousands         | Monetary savings in thousands of units.  | -                    |
| 45.06 | <i>Saved money</i>               | Displays the monetary savings compared to direct-on-line motor connection. This value is a calculated by multiplying the saved energy in kWh by the currently active energy tariff ( <a href="#">45.14 Tariff selection</a> ).<br>When this parameter rolls over, parameter <a href="#">45.05 Saved money x1000</a> is incremented.<br>The currency is defined by parameter <a href="#">45.17 Tariff currency unit</a> .<br>This parameter is read-only (see parameter <a href="#">45.21 Energy calculations reset</a> ).  | -                    |
|       | 0.00 ... 999.99 units            | Monetary savings.  | 1 = 1 unit           |
| 45.08 | <i>CO2 reduction in kilotons</i> | Displays the reduction in CO <sub>2</sub> emissions in metric kilotons compared to direct-on-line motor connection. This value is incremented when parameter <a href="#">45.09 CO2 reduction in tons</a> rolls over.<br>This parameter is read-only (see parameter <a href="#">45.21 Energy calculations reset</a> ).  | -                    |
|       | 0...65535 metric kilotons        | Reduction in CO <sub>2</sub> emissions in metric kilotons.   | 1 = 1 metric kiloton |
| 45.09 | <i>CO2 reduction in tons</i>     | Displays the reduction in CO <sub>2</sub> emissions in metric tons compared to direct-on-line motor connection. This value is calculated by multiplying the saved energy in MWh by the value of parameter <a href="#">45.18 CO2 conversion factor</a> (by default, 0.5 metric tons/MWh).<br>When this parameter rolls over, parameter <a href="#">45.08 CO2 reduction in kilotons</a> is incremented.<br>This parameter is read-only (see parameter <a href="#">45.21 Energy calculations reset</a> ).   | -                    |
|       | 0.0 ... 999.9 metric tons        | Reduction in CO <sub>2</sub> emissions in metric tons.   | 1 = 1 metric ton     |

| No.   | Name/Value                            | Description  | Def/FbEq16                      |
|-------|---------------------------------------|--|---------------------------------|
| 45.11 | <a href="#">Energy optimizer</a>      | Enables/disables the energy optimization function. The function optimizes the motor flux so that total energy consumption and motor noise level are reduced when the drive operates below the nominal load. The total efficiency (motor and drive) can be improved by 1...20% depending on load torque and speed.<br><b>Note:</b> With a permanent magnet motor or a synchronous reluctance motor, energy optimization is always enabled regardless of this parameter. | <a href="#">Disable</a>         |
|       | Disable                               | Energy optimization disabled.  | 0                               |
|       | Enable                                | Energy optimization enabled.   | 1                               |
| 45.12 | <a href="#">Energy tariff 1</a>       | Defines energy tariff 1 (price of energy per kWh). Depending on the setting of parameter <a href="#">45.14 Tariff selection</a> , either this value or <a href="#">45.13 Energy tariff 2</a> is used for reference when monetary savings are calculated.<br>The currency is defined by parameter <a href="#">45.17 Tariff currency unit</a> .<br><b>Note:</b> Tariffs are read only at the instant of selection, and are not applied retroactively.                    | 1.000 units                     |
|       | 0.000 ...<br>4294967.295 units        | Energy tariff 1.   | -                               |
| 45.13 | <a href="#">Energy tariff 2</a>       | Defines energy tariff 2 (price of energy per kWh).<br>See parameter <a href="#">45.12 Energy tariff 1</a> .  | 2.000 units                     |
|       | 0.000 ...<br>4294967.295 units        | Energy tariff 2.   | -                               |
| 45.14 | <a href="#">Tariff selection</a>      | Selects (or defines a source that selects) which pre-defined energy tariff is used.<br>0 = <a href="#">45.12 Energy tariff 1</a><br>1 = <a href="#">45.13 Energy tariff 2</a>  | <a href="#">Energy tariff 1</a> |
|       | Energy tariff 1                       | 0.   | 0                               |
|       | Energy tariff 2                       | 1.   | 1                               |
|       | DI1                                   | Digital input DI1 ( <a href="#">10.02 DI delayed status</a> , bit 0).  | 2                               |
|       | DI2                                   | Digital input DI2 ( <a href="#">10.02 DI delayed status</a> , bit 1).  | 3                               |
|       | DI3                                   | Digital input DI3 ( <a href="#">10.02 DI delayed status</a> , bit 2).  | 4                               |
|       | DI4                                   | Digital input DI4 ( <a href="#">10.02 DI delayed status</a> , bit 3).  | 5                               |
|       | DI5                                   | Digital input DI5 ( <a href="#">10.02 DI delayed status</a> , bit 4).  | 6                               |
|       | DI6                                   | Digital input DI6 ( <a href="#">10.02 DI delayed status</a> , bit 5).  | 7                               |
|       | DIO1                                  | Digital input/output DIO1 ( <a href="#">11.02 DIO delayed status</a> , bit 0).   | 10                              |
|       | DIO2                                  | Digital input/output DIO2 ( <a href="#">11.02 DIO delayed status</a> , bit 1).   | 11                              |
|       | <a href="#">Other [bit]</a>           | Source selection (see <a href="#">Terms and abbreviations</a> on page 112).  | -                               |
| 45.17 | <a href="#">Tariff currency unit</a>  | Specifies the currency used for the savings calculations.  | <a href="#">EUR</a>             |
|       | Local currency                        | Local currency. The name of the currency can be edited by choosing Menu - Settings - Edit texts on the control panel.  | 100                             |
|       | EUR                                   | Euro.  | 101                             |
|       | USD                                   | US dollar.   | 102                             |
| 45.18 | <a href="#">CO2 conversion factor</a> | Defines a factor for conversion of saved energy into CO <sub>2</sub> emissions (kg/kWh or tn/MWh).   | 0.500<br>tn/MWh                 |
|       | 0.000 ... 65.535<br>tn/MWh            | Factor for conversion of saved energy into CO <sub>2</sub> emissions.  | 1 = 1 tn/MWh                    |

## 324 Parameters

| No.                                   | Name/Value                                      | Description  | Def/FbEq16   |
|---------------------------------------|---|--|--|
| 45.19                                 | <i>Comparison power</i>                         | Actual power that the motor absorbs when connected direct-on-line and operating the application. The value is used for reference when energy savings are calculated.<br><b>Note:</b> The accuracy of the energy savings calculation is directly dependent on the accuracy of this value. If nothing is entered here, then the nominal motor power is used by the calculation, but that may inflate the energy savings reported as many motors do not absorb nameplate power.   | 0.0 kW   |
|                                       | 0.0 ... 100000.0 kW                             | Motor power.   | See par. <a href="#">46.04</a>                             |
| 45.21                                 | <i>Energy calculations reset</i>                | Resets the savings counter parameters <a href="#">45.01...45.09</a>  | <i>Done</i>  |
|                                       | Done  | Reset not requested (normal operation), or reset complete.   | 0  |
|                                       | Reset   | Reset the savings counter parameters. The value reverts automatically to <i>Done</i> .   | 1  |
| <b>46 Monitoring/scaling settings</b> |   | Speed supervision settings; actual signal filtering; general scaling settings.   |  |
| 46.01                                 | <i>Speed scaling</i>                            | Defines the maximum speed value used to define the acceleration ramp rate and the initial speed value used to define the deceleration ramp rate (see parameter group <a href="#">23 Speed reference ramp</a> ). The speed acceleration and deceleration ramp times are therefore related to this value ( <b>not</b> to parameter <a href="#">30.12 Maximum speed</a> ).<br>Also defines the 16-bit scaling of speed-related parameters. The value of this parameter corresponds to 20000 in fieldbus, master/follower etc. communication.                      | 1500.00 rpm;<br>1800.00 rpm<br>( <a href="#">95.20</a> b0) |
|                                       | 0.10 ... 30000.00 rpm                           | Acceleration/deceleration terminal/initial speed.  | 1 = 1 rpm  |
| 46.02                                 | <i>Frequency scaling</i>                        | Defines the maximum frequency value used to define the acceleration ramp rate and the initial frequency value used to define deceleration ramp rate (see parameter group <a href="#">28 Frequency reference chain</a> ). The frequency acceleration and deceleration ramp times are therefore related to this value ( <b>not</b> to parameter <a href="#">30.14 Maximum frequency</a> ).<br>Also defines the 16-bit scaling of frequency-related parameters. The value of this parameter corresponds to 20000 in fieldbus, master/follower etc. communication. | 50.00 Hz;<br>60.00 Hz<br>( <a href="#">95.20</a> b0)       |
|                                       | 0.10 ... 1000.00 Hz                             | Acceleration/deceleration terminal/initial frequency.  | 10 = 1 Hz  |
| 46.03                                 | <i>Torque scaling</i>                           | Defines the 16-bit scaling of torque parameters. The value of this parameter (in percent of nominal motor torque) corresponds to 10000 in fieldbus, master/follower etc. communication.<br>See also parameter <a href="#">46.42 Torque decimals</a> .  | 100.0%   |
|                                       | 0.1 ... 1000.0%                                 | Torque corresponding to 10000 on fieldbus.   | 10 = 1%  |
| 46.04                                 | <i>Power scaling</i>                            | Defines the output power value that corresponds to 10000 in fieldbus, master/follower etc. communication. The unit is selected by parameter <a href="#">96.16 Unit selection</a> .   | 1000.00 kW<br>or hp  |
|                                       | 0.10 ... 30000.00 kW or<br>0.10 ... 40214.48 hp | Power corresponding to 10000 on fieldbus.  | 1 = 1 unit   |

| No.   | Name/Value                          | Description  | Def/FbEq16 |
|-------|-------------------------------------|--|------------|
| 46.05 | <i>Current scaling</i>              | Defines the 16-bit scaling of current parameters. The value of this parameter corresponds to 10000 in fieldbus, master/follower etc. communication.  | 10000 A    |
|       | 0...30000 A                         | Current corresponding to 10000 on fieldbus.  | 1 = 1 A    |
| 46.06 | <i>Speed ref zero scaling</i>       | Defines a speed corresponding to a zero reference received from fieldbus (either the embedded fieldbus interface, or interface FBA A or FBA B). For example, with a setting of 500, the fieldbus reference range of 0...20000 would correspond to a speed of 500...[46.01] rpm.<br><b>Note:</b> This parameter is effective only with the ABB Drives communication profile.  | 0.00 rpm   |
|       | 0.00 ... 30000.00 rpm               | Speed corresponding to minimum fieldbus reference.   | 1 = 1 rpm  |
| 46.07 | <i>Frequency ref zero scaling</i>   | Defines a frequency corresponding to a zero reference received from fieldbus (either the embedded fieldbus interface, or interface FBA A or FBA B). For example, with a setting of 30, the fieldbus reference range of 0...20000 would correspond to a speed of 30...[46.02] Hz.<br><b>Note:</b> This parameter is effective only with the ABB Drives communication profile. | 0.00 Hz    |
|       | 0.00 ... 1000.00 Hz                 | Frequency corresponding to minimum fieldbus reference.   | 10 = 1 Hz  |
| 46.11 | <i>Filter time motor speed</i>      | Defines a filter time for signals <i>01.01 Motor speed used</i> , <i>01.02 Motor speed estimated</i> , <i>01.04 Encoder 1 speed filtered</i> and <i>01.05 Encoder 2 speed filtered</i> .   | 500 ms     |
|       | 0...20000 ms                        | Motor speed signal filter time.  | 1 = 1 ms   |
| 46.12 | <i>Filter time output frequency</i> | Defines a filter time for signal <i>01.06 Output frequency</i> .   | 500 ms     |
|       | 0...20000 ms                        | Output frequency signal filter time.   | 1 = 1 ms   |
| 46.13 | <i>Filter time motor torque</i>     | Defines a filter time for signal <i>01.10 Motor torque</i> .   | 100 ms     |
|       | 0...20000 ms                        | Motor torque signal filter time.   | 1 = 1 ms   |
| 46.14 | <i>Filter time power out</i>        | Defines a filter time for signal <i>01.14 Output power</i> .   | 100 ms     |
|       | 0...20000 ms                        | Output power signal filter time.   | 1 = 1 ms   |

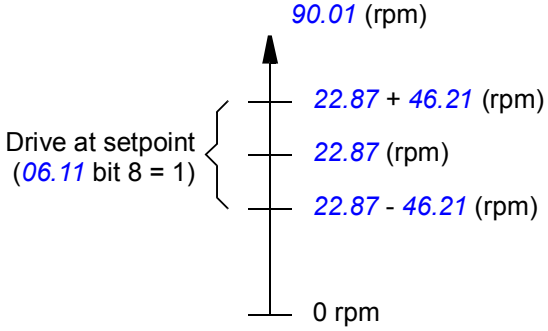
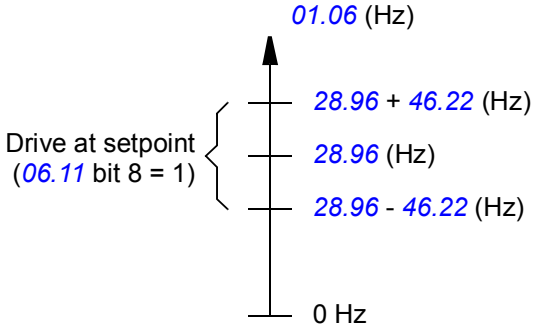
| No.   | Name/Value                     | Description  | Def/FbEq16                     |
|-------|--------------------------------|--|--------------------------------|
| 46.21 | <i>At speed hysteresis</i>     | <p>Defines the “at setpoint” limits for speed control of the drive. When the absolute difference between reference (<a href="#">22.87 Speed reference act 7</a>) and actual speed (<a href="#">90.01 Motor speed for control</a>) is smaller than <a href="#">46.21 At speed hysteresis</a>, the drive is considered to be “at setpoint”. This is indicated by bit 8 of <a href="#">06.11 Main status word</a>.</p>            | 100.00 rpm                     |
|       | 0.00 ... 30000.00 rpm          | Limit for “at setpoint” indication in speed control.   | See par. <a href="#">46.01</a> |
| 46.22 | <i>At frequency hysteresis</i> | <p>Defines the “at setpoint” limits for frequency control of the drive. When the absolute difference between reference (<a href="#">28.96 Frequency ref ramp input</a>) and actual frequency (<a href="#">01.06 Output frequency</a>) is smaller than <a href="#">46.22 At frequency hysteresis</a>, the drive is considered to be “at setpoint”. This is indicated by bit 8 of <a href="#">06.11 Main status word</a>.</p>  | 10.00 Hz                       |
|       | 0.00 ... 1000.00 Hz            | Limit for “at setpoint” indication in frequency control.   | See par. <a href="#">46.02</a> |

| No.   | Name/Value                   | Description   | Def/FbEq16  |                |
|-------|------------------------------|---|---|----------------|
| 46.23 | <i>At torque hysteresis</i>  | Defines the “at setpoint” limits for torque control of the drive. When the absolute difference between reference (26.73 Torque reference act 4) and actual torque (01.10 Motor torque) is smaller than 46.23 At torque hysteresis, the drive is considered to be “at setpoint”. This is indicated by bit 8 of 06.11 Main status word. | 10.0%   |                |
|       |                              |   |   |                |
|       |                              | 0.0 ... 300.0%  | Limit for “at setpoint” indication in torque control.         | See par. 46.03 |
| 46.31 | <i>Above speed limit</i>     | Defines the trigger level for “above limit” indication in speed control. When actual speed exceeds the limit, bit 10 of 06.17 Drive status word 2 is set.   | 1500.00 rpm   |                |
|       |                              | 0.00 ... 30000.00 rpm   | “Above limit” indication trigger level for speed control.     | See par. 46.01 |
| 46.32 | <i>Above frequency limit</i> | Defines the trigger level for “above limit” indication in frequency control. When actual frequency exceeds the limit, bit 10 of 06.17 Drive status word 2 is set.   | 50.00 Hz  |                |
|       |                              | 0.00 ... 1000.00 Hz   | “Above limit” indication trigger level for frequency control. | See par. 46.02 |
| 46.33 | <i>Above torque limit</i>    | Defines the trigger level for “above limit” indication in torque control. When actual torque exceeds the limit, bit 10 of 06.17 Drive status word 2 is set.   | 300.0%  |                |
|       |                              | 0.0 ... 1600.0%   | “Above limit” indication trigger level for torque control.    | See par. 46.03 |
| 46.42 | <i>Torque decimals</i>       | Defines the number of decimal places of torque-related parameters.  | 1   |                |
|       |                              | 0...2   | Number of decimal places of torque parameters.                | 1 = 1          |



| No.   | Name/Value                                      | Description   | Def/FbEq16                     |
|---|---|---|--------------------------------|
| <b>47 Data storage</b>  |   |   |                                |
| Data storage parameters that can be written to and read from using other parameters' source and target settings.<br>Note that there are different storage parameters for different data types. Integer-type storage parameters cannot be used as the source of other parameters.<br>See also section <a href="#">Data storage parameters</a> (page 91). |   |   |                                |
| 47.01   | <a href="#">Data storage 1</a><br><i>real32</i> | Data storage parameter 1.<br>Parameters <a href="#">47.01...47.08</a> are real 32-bit numbers that can be used as source values of other parameters.<br>Storage parameters <a href="#">47.01...47.08</a> can be used as the target of received 16-bit data (parameter group <a href="#">62 D2D and DDCS receive data</a> ) or the source of transmitted 16-bit data (parameter group <a href="#">61 D2D and DDCS transmit data</a> ). The scaling and range are defined by parameters <a href="#">47.31...47.38</a> . | 0.000                          |
|   | See par. <a href="#">47.31</a>                  | 32-bit real (floating point) number.  | See par. <a href="#">47.31</a> |
| 47.02   | <a href="#">Data storage 2</a><br><i>real32</i> | Data storage parameter 2.<br>See also parameter <a href="#">47.01 Data storage 1 real32</a> .   | 0.000                          |
|   | See par. <a href="#">47.32</a>                  | 32-bit real (floating point) number.  | See par. <a href="#">47.32</a> |
| 47.03   | <a href="#">Data storage 3</a><br><i>real32</i> | Data storage parameter 3.<br>See also parameter <a href="#">47.01 Data storage 1 real32</a> .   | 0.000                          |
|   | See par. <a href="#">47.33</a>                  | 32-bit real (floating point) number.  | See par. <a href="#">47.33</a> |
| 47.04   | <a href="#">Data storage 4</a><br><i>real32</i> | Data storage parameter 4.<br>See also parameter <a href="#">47.01 Data storage 1 real32</a> .   | 0.000                          |
|   | See par. <a href="#">47.34</a>                  | 32-bit real (floating point) number.  | See par. <a href="#">47.34</a> |
| 47.05   | <a href="#">Data storage 5</a><br><i>real32</i> | Data storage parameter 5.<br>See also parameter <a href="#">47.01 Data storage 1 real32</a> .   | 0.000                          |
|   | See par. <a href="#">47.35</a>                  | 32-bit real (floating point) number.  | See par. <a href="#">47.35</a> |
| 47.06   | <a href="#">Data storage 6</a><br><i>real32</i> | Data storage parameter 6.<br>See also parameter <a href="#">47.01 Data storage 1 real32</a> .   | 0.000                          |
|   | See par. <a href="#">47.36</a>                  | 32-bit real (floating point) number.  | See par. <a href="#">47.36</a> |
| 47.07   | <a href="#">Data storage 7</a><br><i>real32</i> | Data storage parameter 7.<br>See also parameter <a href="#">47.01 Data storage 1 real32</a> .   | 0.000                          |
|   | See par. <a href="#">47.37</a>                  | 32-bit real (floating point) number.  | See par. <a href="#">47.37</a> |
| 47.08   | <a href="#">Data storage 8</a><br><i>real32</i> | Data storage parameter 8.<br>See also parameter <a href="#">47.01 Data storage 1 real32</a> .   | 0.000                          |
|   | See par. <a href="#">47.38</a>                  | 32-bit real (floating point) number.  | See par. <a href="#">47.38</a> |
| 47.11   | <a href="#">Data storage 1</a><br><i>int32</i>  | Data storage parameter 9.   | 0                              |
|   | -2147483648 ...<br>2147483647                   | 32-bit integer.   | -                              |





| No.   | Name/Value                                     | Description                | Def/FbEq16 |
|-------|--|----------------------------|------------|
| 47.12 | <a href="#">Data storage 2</a><br><i>int32</i> | Data storage parameter 10. | 0          |
|       | -2147483648 ...<br>2147483647                  | 32-bit integer.            | -          |
| 47.13 | <a href="#">Data storage 3</a><br><i>int32</i> | Data storage parameter 11. | 0          |
|       | -2147483648 ...<br>2147483647                  | 32-bit integer.            | -          |
| 47.14 | <a href="#">Data storage 4</a><br><i>int32</i> | Data storage parameter 12. | 0          |
|       | -2147483648 ...<br>2147483647                  | 32-bit integer.            | -          |
| 47.15 | <a href="#">Data storage 5</a><br><i>int32</i> | Data storage parameter 13. | 0          |
|       | -2147483648 ...<br>2147483647                  | 32-bit integer.            | -          |
| 47.16 | <a href="#">Data storage 6</a><br><i>int32</i> | Data storage parameter 14. | 0          |
|       | -2147483648 ...<br>2147483647                  | 32-bit integer.            | -          |
| 47.17 | <a href="#">Data storage 7</a><br><i>int32</i> | Data storage parameter 15. | 0          |
|       | -2147483648 ...<br>2147483647                  | 32-bit integer.            | -          |
| 47.18 | <a href="#">Data storage 8</a><br><i>int32</i> | Data storage parameter 16. | 0          |
|       | -2147483648 ...<br>2147483647                  | 32-bit integer.            | -          |
| 47.21 | <a href="#">Data storage 1</a><br><i>int16</i> | Data storage parameter 17. | 0          |
|       | -32768 ... 32767                               | 16-bit integer.            | 1 = 1      |
| 47.22 | <a href="#">Data storage 2</a><br><i>int16</i> | Data storage parameter 18. | 0          |
|       | -32768 ... 32767                               | 16-bit integer.            | 1 = 1      |
| 47.23 | <a href="#">Data storage 3</a><br><i>int16</i> | Data storage parameter 19. | 0          |
|       | -32768 ... 32767                               | 16-bit integer.            | 1 = 1      |
| 47.24 | <a href="#">Data storage 4</a><br><i>int16</i> | Data storage parameter 20. | 0          |
|       | -32768 ... 32767                               | 16-bit integer.            | 1 = 1      |
| 47.25 | <a href="#">Data storage 5</a><br><i>int16</i> | Data storage parameter 21. | 0          |
|       | -32768 ... 32767                               | 16-bit integer.            | 1 = 1      |
| 47.26 | <a href="#">Data storage 6</a><br><i>int16</i> | Data storage parameter 22. | 0          |
|       | -32768 ... 32767                               | 16-bit integer.            | 1 = 1      |



### 330 Parameters

| No.   | Name/Value   | Description   | Def/FbEq16      |
|-------|--|---|-----------------|
| 47.27 | <a href="#">Data storage 7</a><br><i>int16</i>       | Data storage parameter 23.  | 0               |
|       | -32768 ... 32767                                     | 16-bit integer.   | 1 = 1           |
| 47.28 | <a href="#">Data storage 8</a><br><i>int16</i>       | Data storage parameter 24.  | 0               |
|       | -32768 ... 32767                                     | 16-bit integer.   | 1 = 1           |
| 47.31 | <a href="#">Data storage 1</a><br><i>real32 type</i> | Defines the scaling of parameter <a href="#">47.01 Data storage 1 real32</a> to and from 16-bit integer format. This scaling is used when the data storage parameter is the target of received 16-bit data (defined in parameter group <a href="#">62 D2D and DDCS receive data</a> ), or when the data storage parameter is the source of transmitted 16-bit data (defined in parameter group <a href="#">61 D2D and DDCS transmit data</a> ).<br>The setting also defines the visible range of the storage parameter. | <i>Unscaled</i> |
|       | Unscaled   | Data storage only. Range: -2147483.264 ... 2147473.264.   | 0               |
|       | Transparent  | Scaling: 1 = 1. Range: -32768 ... 32767.  | 1               |
|       | General  | Scaling: 1 = 100. Range: -327.68 ... 327.67.  | 2               |
|       | Torque   | The scaling is defined by parameter <a href="#">46.03 Torque scaling</a> .<br>Range: -1600.0 ... 1600.0.  | 3               |
|       | Speed  | The scaling is defined by parameter <a href="#">46.01 Speed scaling</a> .<br>Range: -30000.00 ... 30000.00.   | 4               |
|       | Frequency  | The scaling is defined by parameter <a href="#">46.02 Frequency scaling</a> .<br>Range: -500.00 ... 500.00.   | 5               |
| 47.32 | <a href="#">Data storage 2</a><br><i>real32 type</i> | Defines the 16-bit scaling of parameter <a href="#">47.02 Data storage 2 real32</a> .<br>See parameter <a href="#">47.31 Data storage 1 real32 type</a> .   | <i>Unscaled</i> |
| 47.33 | <a href="#">Data storage 3</a><br><i>real32 type</i> | Defines the 16-bit scaling of parameter <a href="#">47.03 Data storage 3 real32</a> .<br>See parameter <a href="#">47.31 Data storage 1 real32 type</a> .   | <i>Unscaled</i> |
| 47.34 | <a href="#">Data storage 4</a><br><i>real32 type</i> | Defines the 16-bit scaling of parameter <a href="#">47.04 Data storage 4 real32</a> .<br>See parameter <a href="#">47.31 Data storage 1 real32 type</a> .   | <i>Unscaled</i> |
| 47.35 | <a href="#">Data storage 5</a><br><i>real32 type</i> | Defines the 16-bit scaling of parameter <a href="#">47.05 Data storage 5 real32</a> .<br>See parameter <a href="#">47.31 Data storage 1 real32 type</a> .   | <i>Unscaled</i> |
| 47.36 | <a href="#">Data storage 6</a><br><i>real32 type</i> | Defines the 16-bit scaling of parameter <a href="#">47.06 Data storage 6 real32</a> .<br>See parameter <a href="#">47.31 Data storage 1 real32 type</a> .   | <i>Unscaled</i> |
| 47.37 | <a href="#">Data storage 7</a><br><i>real32 type</i> | Defines the 16-bit scaling of parameter <a href="#">47.07 Data storage 7 real32</a> .<br>See parameter <a href="#">47.31 Data storage 1 real32 type</a> .   | <i>Unscaled</i> |
| 47.38 | <a href="#">Data storage 8</a><br><i>real32 type</i> | Defines the 16-bit scaling of parameter <a href="#">47.08 Data storage 8 real32</a> .<br>See parameter <a href="#">47.31 Data storage 1 real32 type</a> .   | <i>Unscaled</i> |

| No.                                | Name/Value                       | Description  | Def/FbEq16        |
|------------------------------------|----------------------------------|--|-------------------|
| <b>49 Panel port communication</b> |                                  | Communication settings for the control panel port on the drive.  |                   |
| <b>49.01</b>                       | <b>Node ID number</b>            | Defines the node ID of the drive. All devices connected to the network must have a unique node ID.<br><b>Note:</b> For networked drives, it is advisable to reserve ID 1 for spare/replacement drives.   | 1                 |
|                                    | 1...32                           | Node ID.   | 1 = 1             |
| <b>49.03</b>                       | <b>Baud rate</b>                 | Defines the transfer rate of the link.   | <b>230.4 kbps</b> |
|                                    | 38.4 kbps                        | 38.4 kbit/s.   | 1                 |
|                                    | 57.6 kbps                        | 57.6 kbit/s.   | 2                 |
|                                    | 86.4 kbps                        | 86.4 kbit/s.   | 3                 |
|                                    | 115.2 kbps                       | 115.2 kbit/s.  | 4                 |
|                                    | 230.4 kbps                       | 230.4 kbit/s.  | 5                 |
| <b>49.04</b>                       | <b>Communication loss time</b>   | Sets a timeout for control panel (or PC tool) communication. If a communication break lasts longer than the timeout, the action specified by parameter <b>49.05 Communication loss action</b> is taken.  | 10.0 s            |
|                                    | 0.3 ... 3000.0 s                 | Panel/PC tool communication timeout.   | 10 = 1 s          |
| <b>49.05</b>                       | <b>Communication loss action</b> | Selects how the drive reacts to a control panel (or PC tool) communication break.<br>Changes to this parameter take effect after the control unit is rebooted or the new settings validated by parameter <b>49.06 Refresh settings</b> .<br>See also parameters <b>49.07 Panel comm supervision force</b> and <b>49.08 Secondary comm. loss action</b> .   | <b>Fault</b>      |
|                                    | No action                        | No action taken.   | 0                 |
|                                    | Fault                            | Drive trips on <b>7081 Control panel loss</b> . This only occurs if control is expected from the control panel (it is selected as source of start/stop/reference in the currently active control location), or if supervision is forced using parameter <b>49.07 Panel comm supervision force</b> .  | 1                 |
|                                    | Last speed                       | Drive generates an <b>A7EE Control panel loss</b> warning and freezes the speed to the level the drive was operating at. This only occurs if control is expected from the control panel, or if supervision is forced using parameter <b>49.07 Panel comm supervision force</b> .<br>The speed is determined on the basis of actual speed using 850 ms low-pass filtering.<br> <b>WARNING!</b> Make sure that it is safe to continue operation in case of a communication break.       | 2                 |
|                                    | Speed ref safe                   | Drive generates an <b>A7EE Control panel loss</b> warning and sets the speed to the speed defined by parameter <b>22.41 Speed ref safe</b> (or <b>28.41 Frequency ref safe</b> when frequency reference is being used). This only occurs if control is expected from the control panel, or if supervision is forced using parameter <b>49.07 Panel comm supervision force</b> .<br> <b>WARNING!</b> Make sure that it is safe to continue operation in case of a communication break. | 3                 |

| No.   | Name/Value                          | Description  | Def/FbEq16            |     |      |       |   |       |   |   |       |   |   |       |   |        |          |  |
|---|-------------------------------------|--|-----------------------|-----|------|-------|---|-------|---|---|-------|---|---|-------|---|--------|----------|--|
|   | Warning                             | Drive generates an <i>A7EE Control panel loss</i> warning. This only occurs if control is expected from the control panel, or if supervision is forced using parameter <i>49.07 Panel comm supervision force</i> .<br> <b>WARNING!</b> Make sure that it is safe to continue operation in case of a communication break.                  | 5                     |     |      |       |   |       |   |   |       |   |   |       |   |        |          |  |
| <i>49.06</i>  | <i>Refresh settings</i>             | Applies the settings of parameters <i>49.01...49.05</i> .<br><b>Note:</b> Refreshing may cause a communication break, so reconnecting the drive may be required.   | <i>Done</i>           |     |      |       |   |       |   |   |       |   |   |       |   |        |          |  |
|   | Done                                | Refresh done or not requested.   | 0                     |     |      |       |   |       |   |   |       |   |   |       |   |        |          |  |
|   | Refresh                             | Refresh parameters <i>49.01...49.05</i> . The value reverts automatically to <i>Done</i> .   | 1                     |     |      |       |   |       |   |   |       |   |   |       |   |        |          |  |
| <i>49.07</i>  | <i>Panel comm supervision force</i> | Activates control panel communication monitoring separately for each control location (see section <i>Local control vs. external control</i> on page 20).<br>The parameter is primarily intended for monitoring the communication with the panel when it is connected to the application program and not selected as a control source by drive parameters.   | 0000b                 |     |      |       |   |       |   |   |       |   |   |       |   |        |          |  |
| <table border="1"> <thead> <tr> <th>Bit</th> <th>Name</th> <th>Value</th> </tr> </thead> <tbody> <tr> <td>0</td> <td>Ext 1</td> <td>1 = Communication monitoring active when Ext 1 is being used.</td> </tr> <tr> <td>1</td> <td>Ext 2</td> <td>1 = Communication monitoring active when Ext 2 is being used.</td> </tr> <tr> <td>2</td> <td>Local</td> <td>1 = Communication monitoring active when local control is being used.</td> </tr> <tr> <td>3...15</td> <td>Reserved</td> <td></td> </tr> </tbody> </table> |                                     |  |                       | Bit | Name | Value | 0 | Ext 1 | 1 = Communication monitoring active when Ext 1 is being used. | 1 | Ext 2 | 1 = Communication monitoring active when Ext 2 is being used. | 2 | Local | 1 = Communication monitoring active when local control is being used. | 3...15 | Reserved |  |
| Bit   | Name                                | Value  |                       |     |      |       |   |       |   |   |       |   |   |       |   |        |          |  |
| 0   | Ext 1                               | 1 = Communication monitoring active when Ext 1 is being used.  |                       |     |      |       |   |       |   |   |       |   |   |       |   |        |          |  |
| 1   | Ext 2                               | 1 = Communication monitoring active when Ext 2 is being used.  |                       |     |      |       |   |       |   |   |       |   |   |       |   |        |          |  |
| 2   | Local                               | 1 = Communication monitoring active when local control is being used.  |                       |     |      |       |   |       |   |   |       |   |   |       |   |        |          |  |
| 3...15  | Reserved                            |  |                       |     |      |       |   |       |   |   |       |   |   |       |   |        |          |  |
|   | 0000b...0111b                       | Panel communication monitoring selection.  | 1 = 1                 |     |      |       |   |       |   |   |       |   |   |       |   |        |          |  |
| <i>49.08</i>  | <i>Secondary comm. loss action</i>  | Selects how the drive reacts to a control panel (or PC tool) communication break. This action is taken when <ul style="list-style-type: none"> <li>the panel is parametrized as an alternative control or reference source but is not currently the active source, and</li> <li>communication supervision for the active control location is not forced by parameter <i>49.07 Panel comm supervision force</i>.</li> </ul> | <i>No action</i>      |     |      |       |   |       |   |   |       |   |   |       |   |        |          |  |
|   | No action                           | No action taken.   | 0                     |     |      |       |   |       |   |   |       |   |   |       |   |        |          |  |
|   | Warning                             | Drive generates an <i>A7EE Control panel loss</i> warning.<br> <b>WARNING!</b> Make sure that it is safe to continue operation in case of a communication break.  | 5                     |     |      |       |   |       |   |   |       |   |   |       |   |        |          |  |
| <i>49.14</i>  | <i>Panel speed reference unit</i>   | Defines the unit for speed reference when given from the control panel.  | <i>rpm</i>            |     |      |       |   |       |   |   |       |   |   |       |   |        |          |  |
|   | rpm                                 | rpm.   | 0                     |     |      |       |   |       |   |   |       |   |   |       |   |        |          |  |
|   | %                                   | Percent of parameter <i>46.01 Speed scaling</i> .  | 1                     |     |      |       |   |       |   |   |       |   |   |       |   |        |          |  |
| <i>49.15</i>  | <i>Minimum ext speed ref panel</i>  | Defines a minimum limit for control panel speed reference in external control.<br>In local control, the limits in parameter group <i>30 Limits</i> are in force. See section <i>Local control vs. external control</i> (page 20).  | -30000.00 rpm         |     |      |       |   |       |   |   |       |   |   |       |   |        |          |  |
|   | -30000.00 ... 30000.00 rpm          | Minimum speed reference.   | See par. <i>46.01</i> |     |      |       |   |       |   |   |       |   |   |       |   |        |          |  |

| No.                              | Name/Value                             | Description  | Def/FbEq16       |
|----------------------------------|--|--|------------------|
| 49.16                            | <i>Maximum ext speed ref panel</i>     | Defines a maximum limit for control panel speed reference in external control.<br>In local control, the limits in parameter group <i>30 Limits</i> are in force. See section <i>Local control vs. external control</i> (page 20).  | 30000.00 rpm     |
|                                  | -30000.00 ... 30000.00 rpm             | Maximum speed reference.   | See par. 46.01   |
| 49.17                            | <i>Minimum ext frequency ref panel</i> | Defines a minimum limit for control panel frequency reference in external control.<br>In local control, the limits in parameter group <i>30 Limits</i> are in force. See section <i>Local control vs. external control</i> (page 20).  | -500.00 Hz       |
|                                  | -500.00 ... 500.00 Hz                  | Minimum frequency reference.   | See par. 46.02   |
| 49.18                            | <i>Maximum ext frequency ref panel</i> | Defines a maximum limit for control panel frequency reference in external control.<br>In local control, the limits in parameter group <i>30 Limits</i> are in force. See section <i>Local control vs. external control</i> (page 20).  | 500.00 Hz        |
|                                  | -500.00 ... 500.00 Hz                  | Maximum frequency reference.   | See par. 46.02   |
| 49.24                            | <i>Panel actual source</i>             | Selects an actual value to be displayed in the top right corner of the control panel. This parameter is only effective when the control panel is not an active reference source.   | <i>Automatic</i> |
|                                  | Automatic                              | The active reference is displayed.   | 0                |
|                                  | Process PID setpoint actual            | <i>40.03 Process PID setpoint actual</i> (see page 301).   | 1                |
|                                  | <i>Other</i>                           | Source selection (see <i>Terms and abbreviations</i> on page 112).   | -                |
| <b>50 Fieldbus adapter (FBA)</b> |  | Fieldbus communication configuration.<br>See also chapter <i>Fieldbus control through a fieldbus adapter</i> (page 551).   |                  |
| 50.01                            | <i>FBA A enable</i>                    | Enables/disables communication between the drive and fieldbus adapter A, and specifies the slot the adapter is installed into.   | <i>Disable</i>   |
|                                  | Disable                                | Communication between drive and fieldbus adapter A disabled.   | 0                |
|                                  | Option slot 1                          | Communication between drive and fieldbus adapter A enabled. The adapter is in slot 1.  | 1                |
|                                  | Option slot 2                          | Communication between drive and fieldbus adapter A enabled. The adapter is in slot 2.  | 2                |
|                                  | Option slot 3                          | Communication between drive and fieldbus adapter A enabled. The adapter is in slot 3.  | 3                |
| 50.02                            | <i>FBA A comm loss func</i>            | Selects how the drive reacts upon a fieldbus communication break. A time delay for the action can be defined by parameter <i>50.03 FBA A comm loss t out</i> .<br>See also parameter <i>50.26 FBA A comm supervision force</i> .   | <i>No action</i> |
|                                  | No action                              | No action taken.   | 0                |
|                                  | Fault                                  | Drive trips on <i>7510 FBA A communication</i> . This only occurs if control is expected from the FBA A interface (FBA A selected as source of start/stop/reference in the currently active control location), or if supervision is forced using parameter <i>50.26 FBA A comm supervision force</i> . | 1                |

| No.          | Name/Value                   | Description  | Def/FbEq16  |
|--------------|------------------------------|--|-------------|
|              | Last speed                   | Drive generates an <i>A7C1 FBA A communication</i> warning and freezes the speed to the level the drive was operating at. This only occurs if control is expected from the FBA A interface, or if supervision is forced using parameter <i>50.26 FBA A comm supervision force</i> .<br>The speed is determined on the basis of actual speed using 850 ms low-pass filtering.<br> <b>WARNING!</b> Make sure that it is safe to continue operation in case of a communication break.  | 2           |
|              | Speed ref safe               | Drive generates an <i>A7C1 FBA A communication</i> warning and sets the speed to the value defined by parameter <i>22.41 Speed ref safe</i> (when speed reference is being used) or <i>28.41 Frequency ref safe</i> (when frequency reference is being used). This only occurs if control is expected from the FBA A interface, or if supervision is forced using parameter <i>50.26 FBA A comm supervision force</i> .<br> <b>WARNING!</b> Make sure that it is safe to continue operation in case of a communication break. | 3           |
|              | Fault always                 | Drive trips on <i>7510 FBA A communication</i> . This occurs even though no control is expected from the FBA A interface.  | 4           |
|              | Warning                      | Drive generates an <i>A7C1 FBA A communication</i> warning. This only occurs if control is expected from the FBA A interface, or if supervision is forced using parameter <i>50.26 FBA A comm supervision force</i> .<br> <b>WARNING!</b> Make sure that it is safe to continue operation in case of a communication break.   | 5           |
| <i>50.03</i> | <i>FBA A comm loss t out</i> | Defines the time delay before the action defined by parameter <i>50.02 FBA A comm loss func</i> is taken. Time count starts when the communication link fails to update the message.<br>As a rule of thumb, this parameter should be set to at least 3 times the transmit interval of the master.<br><b>Note:</b> There is a 60-second boot-up delay immediately after power-up. During the delay, the communication break monitoring is disabled (but communication itself can be active).  | 0.3 s       |
|              | 0.3 ... 6553.5 s             | Time delay.  | 1 = 1 s     |
| <i>50.04</i> | <i>FBA A ref1 type</i>       | Selects the type and scaling of reference 1 received from fieldbus adapter A.<br><b>Note:</b> Fieldbus-specific communication profiles may use different scalings. For more information, see the manual of the fieldbus adapter.   | <i>Auto</i> |
|              | Auto                         | Type and scaling are chosen automatically according to which reference chain (see settings <i>Torque</i> , <i>Speed</i> , <i>Frequency</i> ) the incoming reference is connected to. If the reference is not connected to any chain, no scaling is applied (as with setting <i>Transparent</i> ).  | 0           |
|              | Transparent                  | No scaling is applied (the 16-bit scaling is 1 = 1 unit).  | 1           |
|              | General                      | Generic reference with a scaling of 100 = 1 (ie. integer and two decimals).  | 2           |
|              | Torque                       | The scaling is defined by parameter <i>46.03 Torque scaling</i> .  | 3           |
|              | Speed                        | The scaling is defined by parameter <i>46.01 Speed scaling</i> .   | 4           |
|              | Frequency                    | The scaling is defined by parameter <i>46.02 Frequency scaling</i> .   | 5           |



| No.   | Name/Value                           | Description  | Def/FbEq16          |
|-------|--------------------------------------|--|---------------------|
| 50.05 | <i>FBA A ref2 type</i>               | Selects the type and scaling of reference 2 received from fieldbus adapter A.<br>See parameter <i>50.04 FBA A ref1 type</i> .  | <i>Auto</i>         |
| 50.07 | <i>FBA A actual 1 type</i>           | Selects the type/source and scaling of actual value 1 transmitted to the fieldbus network through fieldbus adapter A.<br><b>Note:</b> Fieldbus-specific communication profiles may use different scalings. For more information, see the manual of the fieldbus adapter. | <i>Auto</i>         |
|       | Auto                                 | Type/source and scaling follow the type of reference 1 selected by parameter <i>50.04 FBA A ref1 type</i> . See the individual settings below for the sources and scalings.  | 0                   |
|       | Transparent                          | The value selected by parameter <i>50.10 FBA A act1 transparent source</i> is sent as actual value 1. No scaling is applied (the 16-bit scaling is 1 = 1 unit).  | 1                   |
|       | General                              | The value selected by parameter <i>50.10 FBA A act1 transparent source</i> is sent as actual value 1 with a 16-bit scaling of 100 = 1 unit (ie. integer and two decimals).   | 2                   |
|       | Torque                               | <i>01.10 Motor torque</i> is sent as actual value 1. The scaling is defined by parameter <i>46.03 Torque scaling</i> .   | 3                   |
|       | Speed                                | <i>01.01 Motor speed used</i> is sent as actual value 1. The scaling is defined by parameter <i>46.01 Speed scaling</i> .  | 4                   |
|       | Frequency                            | <i>01.06 Output frequency</i> is sent as actual value 1. The scaling is defined by parameter <i>46.02 Frequency scaling</i> .  | 5                   |
|       | Position                             | Motor position is sent as actual value 1. See parameter <i>90.06 Motor position scaled</i> .   | 6                   |
| 50.08 | <i>FBA A actual 2 type</i>           | Selects the type/source and scaling of actual value 2 transmitted to the fieldbus network through fieldbus adapter A.<br>See parameter <i>50.07 FBA A actual 1 type</i> .  | <i>Auto</i>         |
| 50.09 | <i>FBA A SW transparent source</i>   | Selects the source of the fieldbus status word when the fieldbus adapter is set to a transparent communication profile eg. by its configuration parameters (group <i>51 FBA A settings</i> ).  | <i>Not selected</i> |
|       | Not selected                         | No source selected.  | -                   |
|       | <i>Other</i>                         | Source selection (see <i>Terms and abbreviations</i> on page 112).   | -                   |
| 50.10 | <i>FBA A act1 transparent source</i> | When parameter <i>50.07 FBA A actual 1 type</i> is set to <i>Transparent</i> or <i>General</i> , this parameter selects the source of actual value 1 transmitted to the fieldbus network through fieldbus adapter A.   | <i>Not selected</i> |
|       | Not selected                         | No source selected.  | -                   |
|       | <i>Other</i>                         | Source selection (see <i>Terms and abbreviations</i> on page 112).   | -                   |
| 50.11 | <i>FBA A act2 transparent source</i> | When parameter <i>50.08 FBA A actual 2 type</i> is set to <i>Transparent</i> or <i>General</i> , this parameter selects the source of actual value 2 transmitted to the fieldbus network through fieldbus adapter A.   | <i>Not selected</i> |
|       | Not selected                         | No source selected.  | -                   |
|       | <i>Other</i>                         | Source selection (see <i>Terms and abbreviations</i> on page 112).   | -                   |
| 50.12 | <i>FBA A debug mode</i>              | Enables the display of raw (unmodified) data received from and sent to fieldbus adapter A in parameters <i>50.13...50.18</i> . This functionality should only be used for debugging.   | <i>Disable</i>      |
|       | Disable                              | Display of raw data from fieldbus adapter A disabled.  | 0                   |
|       | Fast                                 | Display of raw data from fieldbus adapter A enabled.   | 1                   |



| No.   | Name/Value                    | Description  | Def/FbEq16 |
|-------|-------------------------------|--|------------|
| 50.13 | <i>FBA A control word</i>     | Displays the raw (unmodified) control word sent by the master (PLC) to fieldbus adapter A if debugging is enabled by parameter <a href="#">50.12 FBA A debug mode</a> .<br>This parameter is read-only.  | -          |
|       | 00000000h ...<br>FFFFFFFFh    | Control word sent by master to fieldbus adapter A.   | -          |
| 50.14 | <i>FBA A reference 1</i>      | Displays raw (unmodified) reference REF1 sent by the master (PLC) to fieldbus adapter A if debugging is enabled by parameter <a href="#">50.12 FBA A debug mode</a> .<br>This parameter is read-only.    | -          |
|       | -2147483648 ...<br>2147483647 | Raw REF1 sent by master to fieldbus adapter A.   | -          |
| 50.15 | <i>FBA A reference 2</i>      | Displays raw (unmodified) reference REF2 sent by the master (PLC) to fieldbus adapter A if debugging is enabled by parameter <a href="#">50.12 FBA A debug mode</a> .<br>This parameter is read-only.    | -          |
|       | -2147483648 ...<br>2147483647 | Raw REF2 sent by master to fieldbus adapter A.   | -          |
| 50.16 | <i>FBA A status word</i>      | Displays the raw (unmodified) status word sent by fieldbus adapter A to the master (PLC) if debugging is enabled by parameter <a href="#">50.12 FBA A debug mode</a> .<br>This parameter is read-only.   | -          |
|       | 00000000h ...<br>FFFFFFFFh    | Status word sent by fieldbus adapter A to master.  | -          |
| 50.17 | <i>FBA A actual value 1</i>   | Displays raw (unmodified) actual value ACT1 sent by fieldbus adapter A to the master (PLC) if debugging is enabled by parameter <a href="#">50.12 FBA A debug mode</a> .<br>This parameter is read-only. | -          |
|       | -2147483648 ...<br>2147483647 | Raw ACT1 sent by fieldbus adapter A to master.   | -          |
| 50.18 | <i>FBA A actual value 2</i>   | Displays raw (unmodified) actual value ACT2 sent by fieldbus adapter A to the master (PLC) if debugging is enabled by parameter <a href="#">50.12 FBA A debug mode</a> .<br>This parameter is read-only. | -          |
|       | -2147483648 ...<br>2147483647 | Raw ACT2 sent by fieldbus adapter A to master.   | -          |



| No.               | Name/Value                          | Description   | Def/FbEq16     |               |               |                   |       |   |               |       |   |             |        |   |                  |          |      |               |
|-------------------|-------------------------------------|---|----------------|---------------|---------------|-------------------|-------|---|---------------|-------|---|-------------|--------|---|------------------|----------|------|---------------|
| 50.21             | <i>FBA A timelevel sel</i>          | <p>Selects the communication time levels.</p> <p>In general, lower time levels of read/write services reduce CPU load. The table below shows the time levels of the read/write services for cyclic high and cyclic low data with each parameter setting.</p> <table border="1"> <thead> <tr> <th>Selection</th> <th>Cyclic high *</th> <th>Cyclic low **</th> </tr> </thead> <tbody> <tr> <td><i>Monitoring</i></td> <td>10 ms</td> <td>2 ms</td> </tr> <tr> <td><i>Normal</i></td> <td>2 ms</td> <td>10 ms</td> </tr> <tr> <td><i>Fast</i></td> <td>500 µs</td> <td>2 ms</td> </tr> <tr> <td><i>Very fast</i></td> <td>250 µs</td> <td>2 ms</td> </tr> </tbody> </table> <p>* Cyclic high data consists of fieldbus Status word, Act1 and Act2.<br/> ** Cyclic low data consists of the parameter data mapped to parameter groups <i>52 FBA A data in</i> and <i>53 FBA A data out</i>, and acyclic data.<br/> Control word, Ref1 and Ref2 are handled as interrupts generated on receipt of cyclic high messages.</p> | Selection      | Cyclic high * | Cyclic low ** | <i>Monitoring</i> | 10 ms | 2 ms  | <i>Normal</i> | 2 ms  | 10 ms   | <i>Fast</i> | 500 µs | 2 ms  | <i>Very fast</i> | 250 µs   | 2 ms | <i>Normal</i> |
| Selection         | Cyclic high *                       | Cyclic low **   |                |               |               |                   |       |   |               |       |   |             |        |   |                  |          |      |               |
| <i>Monitoring</i> | 10 ms                               | 2 ms  |                |               |               |                   |       |   |               |       |   |             |        |   |                  |          |      |               |
| <i>Normal</i>     | 2 ms                                | 10 ms   |                |               |               |                   |       |   |               |       |   |             |        |   |                  |          |      |               |
| <i>Fast</i>       | 500 µs                              | 2 ms  |                |               |               |                   |       |   |               |       |   |             |        |   |                  |          |      |               |
| <i>Very fast</i>  | 250 µs                              | 2 ms  |                |               |               |                   |       |   |               |       |   |             |        |   |                  |          |      |               |
|                   | Normal                              | Normal speed.   | 0              |               |               |                   |       |   |               |       |   |             |        |   |                  |          |      |               |
|                   | Fast                                | Fast speed.   | 1              |               |               |                   |       |   |               |       |   |             |        |   |                  |          |      |               |
|                   | Very fast                           | Very fast speed.  | 2              |               |               |                   |       |   |               |       |   |             |        |   |                  |          |      |               |
|                   | Monitoring                          | Low speed. Optimized for PC tool communication and monitoring usage.  | 3              |               |               |                   |       |   |               |       |   |             |        |   |                  |          |      |               |
| 50.26             | <i>FBA A comm supervision force</i> | <p>Activates fieldbus communication monitoring separately for each control location (see section <i>Local control vs. external control</i> on page 20).</p> <p>The parameter is primarily intended for monitoring the communication with FBA A when it is connected to the application program and not selected as a control source by drive parameters.</p>  | 0000b          |               |               |                   |       |   |               |       |   |             |        |   |                  |          |      |               |
|                   |                                     | <table border="1"> <thead> <tr> <th>Bit</th> <th>Name</th> <th>Value</th> </tr> </thead> <tbody> <tr> <td>0</td> <td>Ext 1</td> <td>1 = Communication monitoring active when Ext 1 is being used.</td> </tr> <tr> <td>1</td> <td>Ext 2</td> <td>1 = Communication monitoring active when Ext 2 is being used.</td> </tr> <tr> <td>2</td> <td>Local</td> <td>1 = Communication monitoring active when local control is being used.</td> </tr> <tr> <td>3...15</td> <td>Reserved</td> <td></td> </tr> </tbody> </table>   | Bit            | Name          | Value         | 0                 | Ext 1 | 1 = Communication monitoring active when Ext 1 is being used. | 1             | Ext 2 | 1 = Communication monitoring active when Ext 2 is being used. | 2           | Local  | 1 = Communication monitoring active when local control is being used. | 3...15           | Reserved |      |               |
| Bit               | Name                                | Value   |                |               |               |                   |       |   |               |       |   |             |        |   |                  |          |      |               |
| 0                 | Ext 1                               | 1 = Communication monitoring active when Ext 1 is being used.   |                |               |               |                   |       |   |               |       |   |             |        |   |                  |          |      |               |
| 1                 | Ext 2                               | 1 = Communication monitoring active when Ext 2 is being used.   |                |               |               |                   |       |   |               |       |   |             |        |   |                  |          |      |               |
| 2                 | Local                               | 1 = Communication monitoring active when local control is being used.   |                |               |               |                   |       |   |               |       |   |             |        |   |                  |          |      |               |
| 3...15            | Reserved                            |   |                |               |               |                   |       |   |               |       |   |             |        |   |                  |          |      |               |
|                   | 0000b...0111b                       | FBA A communication monitoring selection.   | 1 = 1          |               |               |                   |       |   |               |       |   |             |        |   |                  |          |      |               |
| 50.31             | <i>FBA B enable</i>                 | Enables/disables communication between the drive and fieldbus adapter B, and specifies the slot the adapter is installed into.  | <i>Disable</i> |               |               |                   |       |   |               |       |   |             |        |   |                  |          |      |               |
|                   | Disable                             | Communication between drive and fieldbus adapter B disabled.  | 0              |               |               |                   |       |   |               |       |   |             |        |   |                  |          |      |               |
|                   | Option slot 1                       | Communication between drive and fieldbus adapter B enabled. The adapter is in slot 1.   | 1              |               |               |                   |       |   |               |       |   |             |        |   |                  |          |      |               |
|                   | Option slot 2                       | Communication between drive and fieldbus adapter B enabled. The adapter is in slot 2.   | 2              |               |               |                   |       |   |               |       |   |             |        |   |                  |          |      |               |
|                   | Option slot 3                       | Communication between drive and fieldbus adapter B enabled. The adapter is in slot 3.   | 3              |               |               |                   |       |   |               |       |   |             |        |   |                  |          |      |               |

| No.   | Name/Value                     | Description  | Def/FbEq16       |
|-------|--------------------------------|--|------------------|
| 50.32 | <i>FBA B comm loss func</i>    | Selects how the drive reacts upon a fieldbus communication break. A time delay for the action can be defined by parameter <a href="#">50.33 FBA B comm loss timeout</a> .<br>See also parameter <a href="#">50.56 FBA B comm supervision force</a> .   | <i>No action</i> |
|       | No action                      | No action taken.   | 0                |
|       | Fault                          | Drive trips on <a href="#">7520 FBA B communication</a> . This only occurs if control is expected from the FBA B interface (FBA B selected as source of start/stop/reference in the currently active control location), or if supervision is forced using parameter <a href="#">50.56 FBA B comm supervision force</a> .   | 1                |
|       | Last speed                     | Drive generates an <a href="#">A7C2 FBA B communication</a> warning and freezes the speed to the level the drive was operating at. This only occurs if control is expected from the FBA B interface, or if supervision is forced using parameter <a href="#">50.56 FBA B comm supervision force</a> .<br>The speed is determined on the basis of actual speed using 850 ms low-pass filtering.<br> <b>WARNING!</b> Make sure that it is safe to continue operation in case of a communication break.  | 2                |
|       | Speed ref safe                 | Drive generates an <a href="#">A7C2 FBA B communication</a> warning and sets the speed to the value defined by parameter <a href="#">22.41 Speed ref safe</a> (when speed reference is being used) or <a href="#">28.41 Frequency ref safe</a> (when frequency reference is being used). This only occurs if control is expected from the FBA B interface, or if supervision is forced using parameter <a href="#">50.56 FBA B comm supervision force</a> .<br> <b>WARNING!</b> Make sure that it is safe to continue operation in case of a communication break. | 3                |
|       | Fault always                   | Drive trips on <a href="#">7520 FBA B communication</a> . This occurs even though no control is expected from the FBA B interface.   | 4                |
|       | Warning                        | Drive generates an <a href="#">A7C2 FBA B communication</a> warning. This only occurs if control is expected from the FBA B interface, or if supervision is forced using parameter <a href="#">50.56 FBA B comm supervision force</a> .<br> <b>WARNING!</b> Make sure that it is safe to continue operation in case of a communication break.   | 5                |
| 50.33 | <i>FBA B comm loss timeout</i> | Defines the time delay before the action defined by parameter <a href="#">50.32 FBA B comm loss func</a> is taken. Time count starts when the communication link fails to update the message.<br>As a rule of thumb, this parameter should be set to at least 3 times the transmit interval of the master.<br><b>Note:</b> There is a 60-second boot-up delay immediately after power-up. During the delay, the communication break monitoring is disabled (but communication itself can be active).   | 0.3 s            |
|       | 0.3 ... 6553.5 s               | Time delay.  | 1 = 1 s          |
| 50.34 | <i>FBA B ref1 type</i>         | Selects the type and scaling of reference 1 received from fieldbus adapter B.<br>See parameter <a href="#">50.04 FBA A ref1 type</a> .   | <i>Auto</i>      |
| 50.35 | <i>FBA B ref2 type</i>         | Selects the type and scaling of reference 2 received from fieldbus adapter B.<br>See parameter <a href="#">50.04 FBA A ref1 type</a> .   | <i>Auto</i>      |

| No.   | Name/Value                           | Description  | Def/FbEq16          |
|-------|--------------------------------------|--|---------------------|
| 50.37 | <i>FBA B actual 1 type</i>           | Selects the type/source and scaling of actual value 1 transmitted to the fieldbus network through fieldbus adapter B. See parameter <i>50.07 FBA A actual 1 type</i> .   | <i>Auto</i>         |
| 50.38 | <i>FBA B actual 2 type</i>           | Selects the type/source and scaling of actual value 2 transmitted to the fieldbus network through fieldbus adapter B. See parameter <i>50.08 FBA A actual 2 type</i> .   | <i>Auto</i>         |
| 50.39 | <i>FBA B SW transparent source</i>   | Selects the source of the fieldbus status word when the fieldbus adapter is set to a transparent communication profile eg. by its configuration parameters (group <i>54 FBA B settings</i> ).                        | <i>Not selected</i> |
|       | Not selected                         | No source selected.  | -                   |
|       | <i>Other</i>                         | Source selection (see <i>Terms and abbreviations</i> on page 112).   | -                   |
| 50.40 | <i>FBA B act1 transparent source</i> | When parameter <i>50.37 FBA B actual 1 type</i> is set to <i>Transparent</i> or <i>General</i> , this parameter selects the source of actual value 1 transmitted to the fieldbus network through fieldbus adapter B. | <i>Not selected</i> |
|       | Not selected                         | No source selected.  | -                   |
|       | <i>Other</i>                         | Source selection (see <i>Terms and abbreviations</i> on page 112).   | -                   |
| 50.41 | <i>FBA B act2 transparent source</i> | When parameter <i>50.38 FBA B actual 2 type</i> is set to <i>Transparent</i> or <i>General</i> , this parameter selects the source of actual value 2 transmitted to the fieldbus network through fieldbus adapter B. | <i>Not selected</i> |
|       | Not selected                         | No source selected.  | -                   |
|       | <i>Other</i>                         | Source selection (see <i>Terms and abbreviations</i> on page 112).   | -                   |
| 50.42 | <i>FBA B debug mode</i>              | Enables the display of raw (unmodified) data received from and sent to fieldbus adapter B in parameters <i>50.43...50.48</i> . This functionality should only be used for debugging.                                 | <i>Disable</i>      |
|       | Disable                              | Display of raw data from fieldbus adapter B disabled.  | 0                   |
|       | Fast                                 | Display of raw data from fieldbus adapter B enabled.   | 1                   |
| 50.43 | <i>FBA B control word</i>            | Displays the raw (unmodified) control word sent by the master (PLC) to fieldbus adapter B if debugging is enabled by parameter <i>50.42 FBA B debug mode</i> . This parameter is read-only.                          | -                   |
|       | 00000000h ...<br>FFFFFFFFh           | Control word sent by master to fieldbus adapter B.   | -                   |
| 50.44 | <i>FBA B reference 1</i>             | Displays raw (unmodified) reference REF1 sent by the master (PLC) to fieldbus adapter B if debugging is enabled by parameter <i>50.42 FBA B debug mode</i> . This parameter is read-only.                            | -                   |
|       | -2147483648 ...<br>2147483647        | Raw REF1 sent by master to fieldbus adapter B.   | -                   |
| 50.45 | <i>FBA B reference 2</i>             | Displays raw (unmodified) reference REF2 sent by the master (PLC) to fieldbus adapter B if debugging is enabled by parameter <i>50.42 FBA B debug mode</i> . This parameter is read-only.                            | -                   |
|       | -2147483648 ...<br>2147483647        | Raw REF2 sent by master to fieldbus adapter B.   | -                   |

## 340 Parameters

| No.               | Name/Value                    | Description  | Def/FbEq16 |               |               |                   |       |      |               |      |       |             |        |      |                  |        |      |               |
|-------------------|-------------------------------|--|------------|---------------|---------------|-------------------|-------|------|---------------|------|-------|-------------|--------|------|------------------|--------|------|---------------|
| 50.46             | <i>FBA B status word</i>      | Displays the raw (unmodified) status word sent by fieldbus adapter B to the master (PLC) if debugging is enabled by parameter <a href="#">50.42 FBA B debug mode</a> .<br>This parameter is read-only.   | -          |               |               |                   |       |      |               |      |       |             |        |      |                  |        |      |               |
|                   | 00000000h ...<br>FFFFFFFFh    | Status word sent by fieldbus adapter B to master.  | -          |               |               |                   |       |      |               |      |       |             |        |      |                  |        |      |               |
| 50.47             | <i>FBA B actual value 1</i>   | Displays raw (unmodified) actual value ACT1 sent by fieldbus adapter B to the master (PLC) if debugging is enabled by parameter <a href="#">50.42 FBA B debug mode</a> .<br>This parameter is read-only.   | -          |               |               |                   |       |      |               |      |       |             |        |      |                  |        |      |               |
|                   | -2147483648 ...<br>2147483647 | Raw ACT1 sent by fieldbus adapter B to master.   | -          |               |               |                   |       |      |               |      |       |             |        |      |                  |        |      |               |
| 50.48             | <i>FBA B actual value 2</i>   | Displays raw (unmodified) actual value ACT2 sent by fieldbus adapter B to the master (PLC) if debugging is enabled by parameter <a href="#">50.42 FBA B debug mode</a> .<br>This parameter is read-only.   | -          |               |               |                   |       |      |               |      |       |             |        |      |                  |        |      |               |
|                   | -2147483648 ...<br>2147483647 | Raw ACT2 sent by fieldbus adapter B to master.   | -          |               |               |                   |       |      |               |      |       |             |        |      |                  |        |      |               |
| 50.51             | <i>FBA B timelevel sel</i>    | <p>Selects the communication time levels.<br/>In general, lower time levels of read/write services reduce CPU load. The table below shows the time levels of the read/write services for cyclic high and cyclic low data with each parameter setting.</p> <table border="1"> <thead> <tr> <th>Selection</th> <th>Cyclic high *</th> <th>Cyclic low **</th> </tr> </thead> <tbody> <tr> <td><i>Monitoring</i></td> <td>10 ms</td> <td>2 ms</td> </tr> <tr> <td><i>Normal</i></td> <td>2 ms</td> <td>10 ms</td> </tr> <tr> <td><i>Fast</i></td> <td>500 µs</td> <td>2 ms</td> </tr> <tr> <td><i>Very fast</i></td> <td>250 µs</td> <td>2 ms</td> </tr> </tbody> </table> <p>* Cyclic high data consists of fieldbus Status word, Act1 and Act2.<br/>** Cyclic low data consists of the parameter data mapped to parameter groups <a href="#">55 FBA B data in</a> and <a href="#">56 FBA B data out</a>, and acyclic data.<br/>Control word, Ref1 and Ref2 are handled as interrupts generated on receipt of cyclic high messages.</p> | Selection  | Cyclic high * | Cyclic low ** | <i>Monitoring</i> | 10 ms | 2 ms | <i>Normal</i> | 2 ms | 10 ms | <i>Fast</i> | 500 µs | 2 ms | <i>Very fast</i> | 250 µs | 2 ms | <i>Normal</i> |
| Selection         | Cyclic high *                 | Cyclic low **  |            |               |               |                   |       |      |               |      |       |             |        |      |                  |        |      |               |
| <i>Monitoring</i> | 10 ms                         | 2 ms   |            |               |               |                   |       |      |               |      |       |             |        |      |                  |        |      |               |
| <i>Normal</i>     | 2 ms                          | 10 ms  |            |               |               |                   |       |      |               |      |       |             |        |      |                  |        |      |               |
| <i>Fast</i>       | 500 µs                        | 2 ms   |            |               |               |                   |       |      |               |      |       |             |        |      |                  |        |      |               |
| <i>Very fast</i>  | 250 µs                        | 2 ms   |            |               |               |                   |       |      |               |      |       |             |        |      |                  |        |      |               |
|                   | Normal                        | Normal speed.  | 0          |               |               |                   |       |      |               |      |       |             |        |      |                  |        |      |               |
|                   | Fast                          | Fast speed.  | 1          |               |               |                   |       |      |               |      |       |             |        |      |                  |        |      |               |
|                   | Very fast                     | Very fast speed.   | 2          |               |               |                   |       |      |               |      |       |             |        |      |                  |        |      |               |
|                   | Monitoring                    | Low speed. Optimized for PC tool communication and monitoring usage.   | 3          |               |               |                   |       |      |               |      |       |             |        |      |                  |        |      |               |

| No.   | Name/Value                          | Description   | Def/FbEq16  |     |      |       |   |       |   |   |       |   |   |       |   |        |          |  |
|---|-------------------------------------|---|-------------|-----|------|-------|---|-------|---|---|-------|---|---|-------|---|--------|----------|--|
| 50.56   | <i>FBA B comm supervision force</i> | Activates fieldbus communication monitoring separately for each control location (see section <i>Local control vs. external control</i> on page 20).<br>The parameter is primarily intended for monitoring the communication with FBA B when it is connected to the application program and not selected as a control source by drive parameters.                             | 0000b       |     |      |       |   |       |   |   |       |   |   |       |   |        |          |  |
| <table border="1"> <thead> <tr> <th>Bit</th> <th>Name</th> <th>Value</th> </tr> </thead> <tbody> <tr> <td>0</td> <td>Ext 1</td> <td>1 = Communication monitoring active when Ext 1 is being used.</td> </tr> <tr> <td>1</td> <td>Ext 2</td> <td>1 = Communication monitoring active when Ext 2 is being used.</td> </tr> <tr> <td>2</td> <td>Local</td> <td>1 = Communication monitoring active when local control is being used.</td> </tr> <tr> <td>3...15</td> <td>Reserved</td> <td></td> </tr> </tbody> </table> |                                     |   |             | Bit | Name | Value | 0 | Ext 1 | 1 = Communication monitoring active when Ext 1 is being used. | 1 | Ext 2 | 1 = Communication monitoring active when Ext 2 is being used. | 2 | Local | 1 = Communication monitoring active when local control is being used. | 3...15 | Reserved |  |
| Bit   | Name                                | Value   |             |     |      |       |   |       |   |   |       |   |   |       |   |        |          |  |
| 0   | Ext 1                               | 1 = Communication monitoring active when Ext 1 is being used.   |             |     |      |       |   |       |   |   |       |   |   |       |   |        |          |  |
| 1   | Ext 2                               | 1 = Communication monitoring active when Ext 2 is being used.   |             |     |      |       |   |       |   |   |       |   |   |       |   |        |          |  |
| 2   | Local                               | 1 = Communication monitoring active when local control is being used.   |             |     |      |       |   |       |   |   |       |   |   |       |   |        |          |  |
| 3...15  | Reserved                            |   |             |     |      |       |   |       |   |   |       |   |   |       |   |        |          |  |
|   | 0000b...0111b                       | FBA B communication monitoring selection.   | 1 = 1       |     |      |       |   |       |   |   |       |   |   |       |   |        |          |  |
| <b>51 FBA A settings</b>  |                                     | Fieldbus adapter A configuration.   |             |     |      |       |   |       |   |   |       |   |   |       |   |        |          |  |
| 51.01   | <i>FBA A type</i>                   | Displays the type of the connected fieldbus adapter module.<br><b>0</b> = Module is not found or is not properly connected, or is disabled by parameter <i>50.01 FBA A enable</i> ; <b>1</b> = FPBA; <b>32</b> = FCAN; <b>37</b> = FDNA; <b>101</b> = FCNA, <b>128</b> = FENA-11/21; <b>135</b> = FECA; <b>136</b> = FEPL; <b>485</b> = FSCA.<br>This parameter is read-only. | -           |     |      |       |   |       |   |   |       |   |   |       |   |        |          |  |
| 51.02   | <i>FBA A Par2</i>                   | Parameters <i>51.02...51.26</i> are adapter module-specific. For more information, see the documentation of the fieldbus adapter module. Note that not all of these parameters are necessarily in use.  | -           |     |      |       |   |       |   |   |       |   |   |       |   |        |          |  |
|   | 0...65535                           | Fieldbus adapter configuration parameter.   | 1 = 1       |     |      |       |   |       |   |   |       |   |   |       |   |        |          |  |
|   | ...                                 | ...   | ...         |     |      |       |   |       |   |   |       |   |   |       |   |        |          |  |
| 51.26   | <i>FBA A Par26</i>                  | See parameter <i>51.02 FBA A Par2</i> .   | -           |     |      |       |   |       |   |   |       |   |   |       |   |        |          |  |
|   | 0...65535                           | Fieldbus adapter configuration parameter.   | 1 = 1       |     |      |       |   |       |   |   |       |   |   |       |   |        |          |  |
| 51.27   | <i>FBA A par refresh</i>            | Validates any changed fieldbus adapter module configuration settings. After refreshing, the value reverts automatically to <i>Done</i> .<br><b>Note:</b> This parameter cannot be changed while the drive is running.   | <i>Done</i> |     |      |       |   |       |   |   |       |   |   |       |   |        |          |  |
|   | Done                                | Refreshing done.  | 0           |     |      |       |   |       |   |   |       |   |   |       |   |        |          |  |
|   | Refresh                             | Refreshing.   | 1           |     |      |       |   |       |   |   |       |   |   |       |   |        |          |  |
| 51.28   | <i>FBA A par table ver</i>          | Displays the parameter table revision of the fieldbus adapter module mapping file (stored in the memory of the drive).<br>In format axyz, where ax = major table revision number; yz = minor table revision number.<br>This parameter is read-only.   | -           |     |      |       |   |       |   |   |       |   |   |       |   |        |          |  |
|   |                                     | Parameter table revision of adapter module.   | -           |     |      |       |   |       |   |   |       |   |   |       |   |        |          |  |
| 51.29   | <i>FBA A drive type code</i>        | Displays the drive type code in the fieldbus adapter module mapping file (stored in the memory of the drive).<br>This parameter is read-only.   | -           |     |      |       |   |       |   |   |       |   |   |       |   |        |          |  |
|   | 0...65535                           | Drive type code stored in the mapping file.   | 1 = 1       |     |      |       |   |       |   |   |       |   |   |       |   |        |          |  |

## 342 Parameters

| No.                     | Name/Value                    | Description  | Def/FbEq16  |
|-------------------------|-------------------------------|--|-------------|
| 51.30                   | <i>FBA A mapping file ver</i> | Displays the fieldbus adapter module mapping file revision stored in the memory of the drive in decimal format. This parameter is read-only.   | -           |
|                         | 0...65535                     | Mapping file revision.   | 1 = 1       |
| 51.31                   | <i>D2FBA A comm status</i>    | Displays the status of the fieldbus adapter module communication.  | -           |
|                         | Not configured                | Adapter is not configured.   | 0           |
|                         | Initializing                  | Adapter is initializing.   | 1           |
|                         | Time out                      | A timeout has occurred in the communication between the adapter and the drive.   | 2           |
|                         | Configuration error           | Adapter configuration error: mapping file not found in the file system of the drive, or mapping file upload has failed more than three times.  | 3           |
|                         | Off-line                      | Fieldbus communication is off-line.  | 4           |
|                         | On-line                       | Fieldbus communication is on-line, or fieldbus adapter has been configured not to detect a communication break. For more information, see the documentation of the fieldbus adapter.   | 5           |
|                         | Reset                         | Adapter is performing a hardware reset.  | 6           |
| 51.32                   | <i>FBA A comm SW ver</i>      | Displays the patch and build versions of the adapter module firmware in format xxyy, where xx = patch version number, yy = build version number.<br>Example: C802 = 200.02 (patch version 200, build version 2).   |             |
|                         |                               | Patch and build versions of adapter module firmware.   | -           |
| 51.33                   | <i>FBA A appl SW ver</i>      | Displays the major and minor versions of the adapter module firmware in format xyy, where x = major revision number, yy = minor revision number.<br>Example: 300 = 3.00 (major version 3, minor version 00).   |             |
|                         |                               | Major and minor versions of adapter module firmware.   | -           |
| <b>52 FBA A data in</b> |                               | Selection of data to be transferred from drive to fieldbus controller through fieldbus adapter A.<br><b>Note:</b> 32-bit values require two consecutive parameters. Whenever a 32-bit value is selected in a data parameter, the next parameter is automatically reserved. |             |
| 52.01                   | <i>FBA A data in1</i>         | Parameters 52.01...52.12 select data to be transferred from the drive to the fieldbus controller through fieldbus adapter A.   | <i>None</i> |
|                         | None                          | None.  | 0           |
|                         | CW 16bit                      | Control Word (16 bits)   | 1           |
|                         | Ref1 16bit                    | Reference REF1 (16 bits)   | 2           |
|                         | Ref2 16bit                    | Reference REF2 (16 bits)   | 3           |
|                         | SW 16bit                      | Status Word (16 bits)  | 4           |
|                         | Act1 16bit                    | Actual value ACT1 (16 bits)  | 5           |
|                         | Act2 16bit                    | Actual value ACT2 (16 bits)  | 6           |
|                         | CW 32bit                      | Control Word (32 bits)   | 11          |
|                         | Ref1 32bit                    | Reference REF1 (32 bits)   | 12          |
|                         | Ref2 32bit                    | Reference REF2 (32 bits)   | 13          |
|                         | SW 32bit                      | Status Word (32 bits)  | 14          |

| No.                      | Name/Value                      | Description   | Def/FbEq16         |
|--------------------------|---------------------------------|---|--------------------|
|                          | Act1 32bit                      | Actual value ACT1 (32 bits)   | 15                 |
|                          | Act2 32bit                      | Actual value ACT2 (32 bits)   | 16                 |
|                          | SW2 16bit                       | Status Word 2 (16 bits)   | 24                 |
|                          | <i>Other</i>                    | Source selection (see <i>Terms and abbreviations</i> on page 112).  | -                  |
| ...                      | ...                             | ...   | ...                |
| <b>52.12</b>             | <b><i>FBA A data in12</i></b>   | See parameter <b>52.01 FBA A data in1</b> .   | <b><i>None</i></b> |
| <b>53 FBA A data out</b> |                                 |   |                    |
|                          |                                 | Selection of data to be transferred from fieldbus controller to drive through fieldbus adapter A.<br><b>Note:</b> 32-bit values require two consecutive parameters. Whenever a 32-bit value is selected in a data parameter, the next parameter is automatically reserved.  |                    |
| <b>53.01</b>             | <b><i>FBA A data out1</i></b>   | Parameters <b>53.01</b> ... <b>53.12</b> select data to be transferred from the fieldbus controller to the drive through fieldbus adapter A.  | <b><i>None</i></b> |
|                          | None                            | None.   | 0                  |
|                          | CW 16bit                        | Control Word (16 bits)  | 1                  |
|                          | Ref1 16bit                      | Reference REF1 (16 bits)  | 2                  |
|                          | Ref2 16bit                      | Reference REF2 (16 bits)  | 3                  |
|                          | CW 32bit                        | Control Word (32 bits)  | 11                 |
|                          | Ref1 32bit                      | Reference REF1 (32 bits)  | 12                 |
|                          | Ref2 32bit                      | Reference REF2 (32 bits)  | 13                 |
|                          | CW2 16bit                       | Control Word 2 (16 bits)  | 21                 |
|                          | <i>Other</i>                    | Source selection (see <i>Terms and abbreviations</i> on page 112).  | -                  |
| ...                      | ...                             | ...   | ...                |
| <b>53.12</b>             | <b><i>FBA A data out12</i></b>  | See parameter <b>53.01 FBA A data out1</b> .  | <b><i>None</i></b> |
| <b>54 FBA B settings</b> |                                 |   |                    |
|                          |                                 | Fieldbus adapter B configuration.   |                    |
| <b>54.01</b>             | <b><i>FBA B type</i></b>        | Displays the type of the connected fieldbus adapter module.<br><b>0</b> = Module is not found or is not properly connected, or is disabled by parameter <b>50.31 FBA B enable</b> ; <b>1</b> = FPBA; <b>32</b> = FCAN; <b>37</b> = FDNA; <b>101</b> = FCNA, <b>128</b> = FENA-11/21; <b>135</b> = FECA; <b>136</b> = FEPL; <b>485</b> = FSCA.<br>This parameter is read-only. | -                  |
| <b>54.02</b>             | <b><i>FBA B Par2</i></b>        | Parameters <b>54.02</b> ... <b>54.26</b> are adapter module-specific. For more information, see the documentation of the fieldbus adapter module. Note that not all of these parameters are necessarily in use.   | -                  |
|                          | 0...65535                       | Fieldbus adapter configuration parameter.   | 1 = 1              |
| ...                      | ...                             | ...   | ...                |
| <b>54.26</b>             | <b><i>FBA B Par26</i></b>       | See parameter <b>54.02 FBA B Par2</b> .   | -                  |
|                          | 0...65535                       | Fieldbus adapter configuration parameter.   | 1 = 1              |
| <b>54.27</b>             | <b><i>FBA B par refresh</i></b> | Validates any changed fieldbus adapter module configuration settings. After refreshing, the value reverts automatically to <b>Done</b> .<br><b>Note:</b> This parameter cannot be changed while the drive is running.   | <b><i>Done</i></b> |
|                          | Done                            | Refreshing done.  | 0                  |



## 344 Parameters



| No.                     | Name/Value                    | Description   | Def/FbEq16 |
|-------------------------|-------------------------------|---|------------|
|                         | Refresh                       | Refreshing.   | 1          |
| 54.28                   | <i>FBA B par table ver</i>    | Displays the parameter table revision of the fieldbus adapter module mapping file (stored in the memory of the drive).<br>In format axyz, where ax = major table revision number; yz = minor table revision number.<br>This parameter is read-only. | -          |
|                         |                               | Parameter table revision of adapter module.   | -          |
| 54.29                   | <i>FBA B drive type code</i>  | Displays the drive type code in the fieldbus adapter module mapping file (stored in the memory of the drive).<br>This parameter is read-only.   | -          |
|                         | 0...65535                     | Drive type code stored in the mapping file.   | 1 = 1      |
| 54.30                   | <i>FBA B mapping file ver</i> | Displays the fieldbus adapter module mapping file revision stored in the memory of the drive in decimal format.<br>This parameter is read-only.   | -          |
|                         | 0...65535                     | Mapping file revision.  | 1 = 1      |
| 54.31                   | <i>D2FBA B comm status</i>    | Displays the status of the fieldbus adapter module communication.   | -          |
|                         | Not configured                | Adapter is not configured.  | 0          |
|                         | Initializing                  | Adapter is initializing.  | 1          |
|                         | Time out                      | A timeout has occurred in the communication between the adapter and the drive.  | 2          |
|                         | Configuration error           | Adapter configuration error: mapping file not found in the file system of the drive, or mapping file upload has failed more than three times.   | 3          |
|                         | Off-line                      | Fieldbus communication is off-line.   | 4          |
|                         | On-line                       | Fieldbus communication is on-line, or fieldbus adapter has been configured not to detect a communication break. For more information, see the documentation of the fieldbus adapter.  | 5          |
|                         | Reset                         | Adapter is performing a hardware reset.   | 6          |
| 54.32                   | <i>FBA B comm SW ver</i>      | Displays the patch and build versions of the adapter module firmware in format xxyy, where xx = patch version number, yy = build version number.<br>Example: C802 = 200.02 (patch version 200, build version 2).                                    |            |
|                         |                               | Patch and build versions of adapter module firmware.  | -          |
| 54.33                   | <i>FBA B appl SW ver</i>      | Displays the major and minor versions of the adapter module firmware in format xyy, where x = major revision number, yy = minor revision number.<br>Example: 300 = 3.00 (major version 3, minor version 00).  |            |
|                         |                               | Major and minor versions of adapter module firmware.  | -          |
| <b>55 FBA B data in</b> |                               | Selection of data to be transferred from drive to fieldbus controller through fieldbus adapter B.   |            |
| 55.01                   | <i>FBA B data in1</i>         | Parameters 55.01...55.12 select data to be transferred from the drive to the fieldbus controller through fieldbus adapter B.  | None       |
|                         | None                          | None.   | 0          |
|                         | CW 16bit                      | Control Word (16 bits)  | 1          |
|                         | Ref1 16bit                    | Reference REF1 (16 bits)  | 2          |
|                         | Ref2 16bit                    | Reference REF2 (16 bits)  | 3          |



| No.                         | Name/Value              | Description   | Def/FbEq16  |
|-----------------------------|-------------------------|---|-------------|
|                             | SW 16bit                | Status Word (16 bits)   | 4           |
|                             | Act1 16bit              | Actual value ACT1 (16 bits)   | 5           |
|                             | Act2 16bit              | Actual value ACT2 (16 bits)   | 6           |
|                             | CW 32bit                | Control Word (32 bits)  | 11          |
|                             | Ref1 32bit              | Reference REF1 (32 bits)  | 12          |
|                             | Ref2 32bit              | Reference REF2 (32 bits)  | 13          |
|                             | SW 32bit                | Status Word (32 bits)   | 14          |
|                             | Act1 32bit              | Actual value ACT1 (32 bits)   | 15          |
|                             | Act2 32bit              | Actual value ACT2 (32 bits)   | 16          |
|                             | SW2 16bit               | Status Word 2 (16 bits)   | 24          |
|                             | <i>Other</i>            | Source selection (see <i>Terms and abbreviations</i> on page 112).  | -           |
| ...                         | ...                     | ...   | ...         |
| <b>55.12</b>                | <b>FBA B data in12</b>  | See parameter <b>55.01 FBA B data in1</b> .   | <i>None</i> |
| <b>56 FBA B data out</b>    |                         | Selection of data to be transferred from fieldbus controller to drive through fieldbus adapter B.   |             |
| <b>56.01</b>                | <b>FBA B data out1</b>  | Parameters <b>56.01</b> ... <b>56.12</b> select data to be transferred from the fieldbus controller to the drive through fieldbus adapter B.  | <i>None</i> |
|                             | None                    | None.   | 0           |
|                             | CW 16bit                | Control Word (16 bits)  | 1           |
|                             | Ref1 16bit              | Reference REF1 (16 bits)  | 2           |
|                             | Ref2 16bit              | Reference REF2 (16 bits)  | 3           |
|                             | CW 32bit                | Control Word (32 bits)  | 11          |
|                             | Ref1 32bit              | Reference REF1 (32 bits)  | 12          |
|                             | Ref2 32bit              | Reference REF2 (32 bits)  | 13          |
|                             | CW2 16bit               | Control Word 2 (16 bits)  | 21          |
|                             | <i>Other</i>            | Source selection (see <i>Terms and abbreviations</i> on page 112).  | -           |
| ...                         | ...                     | ...   | ...         |
| <b>56.12</b>                | <b>FBA B data out12</b> | See parameter <b>56.01 FBA B data out1</b> .  | <i>None</i> |
| <b>58 Embedded fieldbus</b> |                         | Configuration of the embedded fieldbus (EFB) interface. See also chapter <i>Fieldbus control through the embedded fieldbus interface (EFB)</i> (page 527).  |             |
| <b>58.01</b>                | <b>Protocol enable</b>  | Enables/disables the embedded fieldbus interface and selects the protocol to use.<br><b>Note:</b> When the embedded fieldbus interface is enabled, the drive-to-drive link functionality is automatically disabled. | <i>None</i> |
|                             | None                    | None (communication disabled).  | 0           |
|                             | Modbus RTU              | Embedded fieldbus interface is enabled and uses the Modbus RTU protocol.  | 1           |
| <b>58.02</b>                | <b>Protocol ID</b>      | Displays the protocol ID and revision. This parameter is read-only.   | -           |
|                             |                         | Protocol ID and revision.   | 1 = 1       |

| No.   | Name/Value                   | Description  | Def/FbEq16 |
|-------|------------------------------|--|------------|
| 58.03 | <i>Node address</i>          | Defines the node address of the drive on the fieldbus link. Values 1...247 are allowable. Two devices with the same address are not allowed on-line. Changes to this parameter take effect after the control unit is rebooted or the new settings validated by parameter <a href="#">58.06 Communication control</a> . | 1          |
|       | 0...255                      | Node address (values 1...247 are allowable).   | 1 = 1      |
| 58.04 | <i>Baud rate</i>             | Selects the transfer rate of the fieldbus link. Changes to this parameter take effect after the control unit is rebooted or the new settings validated by parameter <a href="#">58.06 Communication control</a> .  | 19.2 kbps  |
|       | 9.6 kbps                     | 9.6 kbit/s.  | 2          |
|       | 19.2 kbps                    | 19.2 kbit/s.   | 3          |
|       | 38.4 kbps                    | 38.4 kbit/s.   | 4          |
|       | 57.6 kbps                    | 57.6 kbit/s.   | 5          |
|       | 76.8 kbps                    | 76.8 kbit/s.   | 6          |
|       | 115.2 kbps                   | 115.2 kbit/s.  | 7          |
| 58.05 | <i>Parity</i>                | Selects the type of parity bit and the number of stop bits. Changes to this parameter take effect after the control unit is rebooted or the new settings validated by parameter <a href="#">58.06 Communication control</a> .  | 8 EVEN 1   |
|       | 8 NONE 1                     | Eight data bits, no parity bit, one stop bit.  | 0          |
|       | 8 NONE 2                     | Eight data bits, no parity bit, two stop bits.   | 1          |
|       | 8 EVEN 1                     | Eight data bits, even parity bit, one stop bit.  | 2          |
|       | 8 ODD 1                      | Eight data bits, odd parity bit, one stop bit.   | 3          |
| 58.06 | <i>Communication control</i> | Validates any changes in the EFB settings, or activates silent mode.   | Enabled    |
|       | Enabled                      | Normal operation.  | 0          |
|       | Refresh settings             | Validates any changed EFB configuration settings. Reverts automatically to <i>Enabled</i> .  | 1          |
|       | Silent mode                  | Activates silent mode (no messages are transmitted). Silent mode can be terminated by activating the <i>Refresh settings</i> selection of this parameter.  | 2          |

| No.   | Name/Value                       | Description   | Def/FbEq16 |      |             |   |             |                               |   |                 |  |   |             |  |   |             |          |   |              |  |   |              |  |   |                 |  |   |                 |  |   |            |  |   |                           |   |    |           |  |    |             |   |    |            |          |    |            |          |    |            |          |    |                |          |  |
|-------|----------------------------------|---|------------|------|-------------|---|-------------|-------------------------------|---|-----------------|--|---|-------------|--|---|-------------|----------|---|--------------|--|---|--------------|--|---|-----------------|--|---|-----------------|--|---|------------|--|---|---------------------------|---|----|-----------|--|----|-------------|---|----|------------|----------|----|------------|----------|----|------------|----------|----|----------------|----------|--|
| 58.07 | <i>Communication diagnostics</i> | Displays the status of the EFB communication.<br>This parameter is read-only.   | -          |      |             |   |             |                               |   |                 |  |   |             |  |   |             |          |   |              |  |   |              |  |   |                 |  |   |                 |  |   |            |  |   |                           |   |    |           |  |    |             |   |    |            |          |    |            |          |    |            |          |    |                |          |  |
|       |                                  | <table border="1"> <thead> <tr> <th>Bit</th> <th>Name</th> <th>Description</th> </tr> </thead> <tbody> <tr> <td>0</td> <td>Init failed</td> <td>1 = EFB initialization failed</td> </tr> <tr> <td>1</td> <td>Addr config err</td> <td>1 = Node address not allowed by protocol</td> </tr> <tr> <td>2</td> <td>Silent mode</td> <td>1 = Drive not allowed to transmit<br/>0 = Drive allowed to transmit</td> </tr> <tr> <td>3</td> <td>Autobauding</td> <td>Reserved</td> </tr> <tr> <td>4</td> <td>Wiring error</td> <td>1 = Errors detected (A/B wires possibly swapped)</td> </tr> <tr> <td>5</td> <td>Parity error</td> <td>1 = Error detected: check parameters <a href="#">58.04</a> and <a href="#">58.05</a></td> </tr> <tr> <td>6</td> <td>Baud rate error</td> <td>1 = Error detected: check parameters <a href="#">58.05</a> and <a href="#">58.04</a></td> </tr> <tr> <td>7</td> <td>No bus activity</td> <td>1 = 0 bytes received during last 5 seconds</td> </tr> <tr> <td>8</td> <td>No packets</td> <td>1 = 0 packets (addressed to any device) detected during last 5 seconds</td> </tr> <tr> <td>9</td> <td>Noise or addressing error</td> <td>1 = Errors detected (interference, or another device with the same address on line)</td> </tr> <tr> <td>10</td> <td>Comm loss</td> <td>1 = 0 packets addressed to the drive received within timeout (<a href="#">58.16</a>)</td> </tr> <tr> <td>11</td> <td>CW/Ref loss</td> <td>1 = No control word or references received within timeout (<a href="#">58.16</a>)</td> </tr> <tr> <td>12</td> <td>Not active</td> <td>Reserved</td> </tr> <tr> <td>13</td> <td>Protocol 1</td> <td>Reserved</td> </tr> <tr> <td>14</td> <td>Protocol 2</td> <td>Reserved</td> </tr> <tr> <td>15</td> <td>Internal error</td> <td>Reserved</td> </tr> </tbody> </table> | Bit        | Name | Description | 0 | Init failed | 1 = EFB initialization failed | 1 | Addr config err | 1 = Node address not allowed by protocol | 2 | Silent mode | 1 = Drive not allowed to transmit<br>0 = Drive allowed to transmit | 3 | Autobauding | Reserved | 4 | Wiring error | 1 = Errors detected (A/B wires possibly swapped) | 5 | Parity error | 1 = Error detected: check parameters <a href="#">58.04</a> and <a href="#">58.05</a> | 6 | Baud rate error | 1 = Error detected: check parameters <a href="#">58.05</a> and <a href="#">58.04</a> | 7 | No bus activity | 1 = 0 bytes received during last 5 seconds | 8 | No packets | 1 = 0 packets (addressed to any device) detected during last 5 seconds | 9 | Noise or addressing error | 1 = Errors detected (interference, or another device with the same address on line) | 10 | Comm loss | 1 = 0 packets addressed to the drive received within timeout ( <a href="#">58.16</a> ) | 11 | CW/Ref loss | 1 = No control word or references received within timeout ( <a href="#">58.16</a> ) | 12 | Not active | Reserved | 13 | Protocol 1 | Reserved | 14 | Protocol 2 | Reserved | 15 | Internal error | Reserved |  |
| Bit   | Name                             | Description   |            |      |             |   |             |                               |   |                 |  |   |             |  |   |             |          |   |              |  |   |              |  |   |                 |  |   |                 |  |   |            |  |   |                           |   |    |           |  |    |             |   |    |            |          |    |            |          |    |            |          |    |                |          |  |
| 0     | Init failed                      | 1 = EFB initialization failed   |            |      |             |   |             |                               |   |                 |  |   |             |  |   |             |          |   |              |  |   |              |  |   |                 |  |   |                 |  |   |            |  |   |                           |   |    |           |  |    |             |   |    |            |          |    |            |          |    |            |          |    |                |          |  |
| 1     | Addr config err                  | 1 = Node address not allowed by protocol  |            |      |             |   |             |                               |   |                 |  |   |             |  |   |             |          |   |              |  |   |              |  |   |                 |  |   |                 |  |   |            |  |   |                           |   |    |           |  |    |             |   |    |            |          |    |            |          |    |            |          |    |                |          |  |
| 2     | Silent mode                      | 1 = Drive not allowed to transmit<br>0 = Drive allowed to transmit  |            |      |             |   |             |                               |   |                 |  |   |             |  |   |             |          |   |              |  |   |              |  |   |                 |  |   |                 |  |   |            |  |   |                           |   |    |           |  |    |             |   |    |            |          |    |            |          |    |            |          |    |                |          |  |
| 3     | Autobauding                      | Reserved  |            |      |             |   |             |                               |   |                 |  |   |             |  |   |             |          |   |              |  |   |              |  |   |                 |  |   |                 |  |   |            |  |   |                           |   |    |           |  |    |             |   |    |            |          |    |            |          |    |            |          |    |                |          |  |
| 4     | Wiring error                     | 1 = Errors detected (A/B wires possibly swapped)  |            |      |             |   |             |                               |   |                 |  |   |             |  |   |             |          |   |              |  |   |              |  |   |                 |  |   |                 |  |   |            |  |   |                           |   |    |           |  |    |             |   |    |            |          |    |            |          |    |            |          |    |                |          |  |
| 5     | Parity error                     | 1 = Error detected: check parameters <a href="#">58.04</a> and <a href="#">58.05</a>  |            |      |             |   |             |                               |   |                 |  |   |             |  |   |             |          |   |              |  |   |              |  |   |                 |  |   |                 |  |   |            |  |   |                           |   |    |           |  |    |             |   |    |            |          |    |            |          |    |            |          |    |                |          |  |
| 6     | Baud rate error                  | 1 = Error detected: check parameters <a href="#">58.05</a> and <a href="#">58.04</a>  |            |      |             |   |             |                               |   |                 |  |   |             |  |   |             |          |   |              |  |   |              |  |   |                 |  |   |                 |  |   |            |  |   |                           |   |    |           |  |    |             |   |    |            |          |    |            |          |    |            |          |    |                |          |  |
| 7     | No bus activity                  | 1 = 0 bytes received during last 5 seconds  |            |      |             |   |             |                               |   |                 |  |   |             |  |   |             |          |   |              |  |   |              |  |   |                 |  |   |                 |  |   |            |  |   |                           |   |    |           |  |    |             |   |    |            |          |    |            |          |    |            |          |    |                |          |  |
| 8     | No packets                       | 1 = 0 packets (addressed to any device) detected during last 5 seconds  |            |      |             |   |             |                               |   |                 |  |   |             |  |   |             |          |   |              |  |   |              |  |   |                 |  |   |                 |  |   |            |  |   |                           |   |    |           |  |    |             |   |    |            |          |    |            |          |    |            |          |    |                |          |  |
| 9     | Noise or addressing error        | 1 = Errors detected (interference, or another device with the same address on line)   |            |      |             |   |             |                               |   |                 |  |   |             |  |   |             |          |   |              |  |   |              |  |   |                 |  |   |                 |  |   |            |  |   |                           |   |    |           |  |    |             |   |    |            |          |    |            |          |    |            |          |    |                |          |  |
| 10    | Comm loss                        | 1 = 0 packets addressed to the drive received within timeout ( <a href="#">58.16</a> )  |            |      |             |   |             |                               |   |                 |  |   |             |  |   |             |          |   |              |  |   |              |  |   |                 |  |   |                 |  |   |            |  |   |                           |   |    |           |  |    |             |   |    |            |          |    |            |          |    |            |          |    |                |          |  |
| 11    | CW/Ref loss                      | 1 = No control word or references received within timeout ( <a href="#">58.16</a> )   |            |      |             |   |             |                               |   |                 |  |   |             |  |   |             |          |   |              |  |   |              |  |   |                 |  |   |                 |  |   |            |  |   |                           |   |    |           |  |    |             |   |    |            |          |    |            |          |    |            |          |    |                |          |  |
| 12    | Not active                       | Reserved  |            |      |             |   |             |                               |   |                 |  |   |             |  |   |             |          |   |              |  |   |              |  |   |                 |  |   |                 |  |   |            |  |   |                           |   |    |           |  |    |             |   |    |            |          |    |            |          |    |            |          |    |                |          |  |
| 13    | Protocol 1                       | Reserved  |            |      |             |   |             |                               |   |                 |  |   |             |  |   |             |          |   |              |  |   |              |  |   |                 |  |   |                 |  |   |            |  |   |                           |   |    |           |  |    |             |   |    |            |          |    |            |          |    |            |          |    |                |          |  |
| 14    | Protocol 2                       | Reserved  |            |      |             |   |             |                               |   |                 |  |   |             |  |   |             |          |   |              |  |   |              |  |   |                 |  |   |                 |  |   |            |  |   |                           |   |    |           |  |    |             |   |    |            |          |    |            |          |    |            |          |    |                |          |  |
| 15    | Internal error                   | Reserved  |            |      |             |   |             |                               |   |                 |  |   |             |  |   |             |          |   |              |  |   |              |  |   |                 |  |   |                 |  |   |            |  |   |                           |   |    |           |  |    |             |   |    |            |          |    |            |          |    |            |          |    |                |          |  |
|       | 0000h...FFFFh                    | EFB communication status.   | 1 = 1      |      |             |   |             |                               |   |                 |  |   |             |  |   |             |          |   |              |  |   |              |  |   |                 |  |   |                 |  |   |            |  |   |                           |   |    |           |  |    |             |   |    |            |          |    |            |          |    |            |          |    |                |          |  |
| 58.08 | <i>Received packets</i>          | Displays a count of valid packets addressed to the drive. During normal operation, this number increases constantly. Can be reset from the control panel by keeping Reset depressed for over 3 seconds.   | -          |      |             |   |             |                               |   |                 |  |   |             |  |   |             |          |   |              |  |   |              |  |   |                 |  |   |                 |  |   |            |  |   |                           |   |    |           |  |    |             |   |    |            |          |    |            |          |    |            |          |    |                |          |  |
|       | 0...4294967295                   | Number of received packets addressed to the drive.  | 1 = 1      |      |             |   |             |                               |   |                 |  |   |             |  |   |             |          |   |              |  |   |              |  |   |                 |  |   |                 |  |   |            |  |   |                           |   |    |           |  |    |             |   |    |            |          |    |            |          |    |            |          |    |                |          |  |
| 58.09 | <i>Transmitted packets</i>       | Displays a count of valid packets transmitted by the drive. During normal operation, this number increases constantly. Can be reset from the control panel by keeping Reset depressed for over 3 seconds.   | -          |      |             |   |             |                               |   |                 |  |   |             |  |   |             |          |   |              |  |   |              |  |   |                 |  |   |                 |  |   |            |  |   |                           |   |    |           |  |    |             |   |    |            |          |    |            |          |    |            |          |    |                |          |  |
|       | 0...4294967295                   | Number of transmitted packets.  | 1 = 1      |      |             |   |             |                               |   |                 |  |   |             |  |   |             |          |   |              |  |   |              |  |   |                 |  |   |                 |  |   |            |  |   |                           |   |    |           |  |    |             |   |    |            |          |    |            |          |    |            |          |    |                |          |  |
| 58.10 | <i>All packets</i>               | Displays a count of valid packets addressed to any device on the bus. During normal operation, this number increases constantly. Can be reset from the control panel by keeping Reset depressed for over 3 seconds.   | -          |      |             |   |             |                               |   |                 |  |   |             |  |   |             |          |   |              |  |   |              |  |   |                 |  |   |                 |  |   |            |  |   |                           |   |    |           |  |    |             |   |    |            |          |    |            |          |    |            |          |    |                |          |  |
|       | 0...4294967295                   | Number of all received packets.   | 1 = 1      |      |             |   |             |                               |   |                 |  |   |             |  |   |             |          |   |              |  |   |              |  |   |                 |  |   |                 |  |   |            |  |   |                           |   |    |           |  |    |             |   |    |            |          |    |            |          |    |            |          |    |                |          |  |
| 58.11 | <i>UART errors</i>               | Displays a count of character errors received by the drive. An increasing count indicates a configuration problem on the bus. Can be reset from the control panel by keeping Reset depressed for over 3 seconds.  | -          |      |             |   |             |                               |   |                 |  |   |             |  |   |             |          |   |              |  |   |              |  |   |                 |  |   |                 |  |   |            |  |   |                           |   |    |           |  |    |             |   |    |            |          |    |            |          |    |            |          |    |                |          |  |
|       | 0...4294967295                   | Number of UART errors.  | 1 = 1      |      |             |   |             |                               |   |                 |  |   |             |  |   |             |          |   |              |  |   |              |  |   |                 |  |   |                 |  |   |            |  |   |                           |   |    |           |  |    |             |   |    |            |          |    |            |          |    |            |          |    |                |          |  |

| No.   | Name/Value                       | Description   | Def/FbEq16              |
|-------|----------------------------------|---|-------------------------|
| 58.12 | <i>CRC errors</i>                | Displays a count of packets with a CRC error received by the drive. An increasing count indicates interference on the bus. Can be reset from the control panel by keeping Reset depressed for over 3 seconds.   | -                       |
|       | 0...4294967295                   | Number of CRC errors.   | 1 = 1                   |
| 58.14 | <i>Communication loss action</i> | Selects how the drive reacts to an EFB communication break. Changes to this parameter take effect after the control unit is rebooted or the new settings validated by parameter <a href="#">58.06 Communication control</a> . See also parameters <a href="#">58.15 Communication loss mode</a> and <a href="#">58.16 Communication loss time</a> .   | <i>Fault</i>            |
|       | No                               | No action taken (monitoring disabled).  | 0                       |
|       | Fault                            | Drive trips on <a href="#">6681 EFB comm loss</a> . This only occurs if control is expected from the EFB (EFB selected as source of start/stop/reference in the currently active control location), or if supervision is forced using parameter <a href="#">58.36 EFB comm supervision force</a> .  | 1                       |
|       | Last speed                       | Drive generates an <a href="#">A7CE EFB comm loss</a> warning and freezes the speed to the level the drive was operating at. This only occurs if control is expected from the EFB, or if supervision is forced using parameter <a href="#">58.36 EFB comm supervision force</a> .<br>The speed is determined on the basis of actual speed using 850 ms low-pass filtering.<br> <b>WARNING!</b> Make sure that it is safe to continue operation in case of a communication break.                         | 2                       |
|       | Speed ref safe                   | Drive generates an <a href="#">A7CE EFB comm loss</a> warning and sets the speed to the speed defined by parameter <a href="#">22.41 Speed ref safe</a> (or <a href="#">28.41 Frequency ref safe</a> when frequency reference is being used). This only occurs if control is expected from the EFB, or if supervision is forced using parameter <a href="#">58.36 EFB comm supervision force</a> .<br> <b>WARNING!</b> Make sure that it is safe to continue operation in case of a communication break. | 3                       |
|       | Fault always                     | Drive trips on <a href="#">6681 EFB comm loss</a> . This occurs even though no control is expected from the EFB.  | 4                       |
|       | Warning                          | Drive generates an <a href="#">A7CE EFB comm loss</a> warning. This only occurs if control is expected from the EFB, or if supervision is forced using parameter <a href="#">58.36 EFB comm supervision force</a> .<br> <b>WARNING!</b> Make sure that it is safe to continue operation in case of a communication break.  | 5                       |
| 58.15 | <i>Communication loss mode</i>   | Defines which message types reset the timeout counter for detecting an EFB communication loss. Changes to this parameter take effect after the control unit is rebooted or the new settings validated by parameter <a href="#">58.06 Communication control</a> . See also parameters <a href="#">58.14 Communication loss action</a> and <a href="#">58.16 Communication loss time</a> .  | <i>Cw / Ref1 / Ref2</i> |
|       | Any message                      | Any message addressed to the drive resets the timeout.  | 1                       |
|       | Cw / Ref1 / Ref2                 | A write of the control word or a reference from the fieldbus resets the timeout.  | 2                       |

| No.   | Name/Value                     | Description  | Def/FbEq16                 |
|-------|--------------------------------|--|----------------------------|
| 58.16 | <i>Communication loss time</i> | Sets a timeout for EFB communication. If a communication break lasts longer than the timeout, the action specified by parameter <a href="#">58.14 Communication loss action</a> is taken. Changes to this parameter take effect after the control unit is rebooted or the new settings validated by parameter <a href="#">58.06 Communication control</a> .<br><b>Note:</b> There is a 30-second boot-up delay immediately after power-up. During the delay, the communication break monitoring is disabled (but communication itself can be active). See also parameter <a href="#">58.15 Communication loss mode</a> . | 3.0 s                      |
|       | 0.0 ... 6000.0 s               | EFB communication timeout.   | 1 = 1                      |
| 58.17 | <i>Transmit delay</i>          | Defines a minimum response delay in addition to any fixed delay imposed by the protocol. Changes to this parameter take effect after the control unit is rebooted or the new settings validated by parameter <a href="#">58.06 Communication control</a> .   | 0 ms                       |
|       | 0...65535 ms                   | Minimum response delay.  | 1 = 1                      |
| 58.18 | <i>EFB control word</i>        | Displays the raw (unmodified) control word sent by the Modbus controller to the drive. For debugging purposes. This parameter is read-only.  | -                          |
|       | 0000h...FFFFh                  | Control word sent by Modbus controller to the drive.   | 1 = 1                      |
| 58.19 | <i>EFB status word</i>         | Displays the raw (unmodified) status word sent by the drive to the Modbus controller. For debugging purposes. This parameter is read-only.   | -                          |
|       | 0000h...FFFFh                  | Status word sent by the drive to the Modbus controller.  | 1 = 1                      |
| 58.25 | <i>Control profile</i>         | Defines the control profile used by the protocol.  | <a href="#">ABB Drives</a> |
|       | ABB Drives                     | ABB Drives profile (with a 16-bit control word) with registers in the classic format for backward compatibility.   | 0                          |
|       | Transparent                    | Transparent profile (16-bit or 32-bit control word) with registers in the classic format.  | 2                          |
| 58.26 | <i>EFB ref1 type</i>           | Selects the type and scaling of reference 1 received through the embedded fieldbus interface. The scaled reference is displayed by <a href="#">03.09 EFB reference 1</a> .   | <a href="#">Auto</a>       |
|       | Auto                           | Type and scaling are chosen automatically according to which reference chain (see settings <a href="#">Torque</a> , <a href="#">Speed</a> , <a href="#">Frequency</a> ) the incoming reference is connected to. If the reference is not connected to any chain, no scaling is applied (as with setting <a href="#">Transparent</a> ).  | 0                          |
|       | Transparent                    | No scaling is applied.   | 1                          |
|       | General                        | Generic reference with a scaling of 100 = 1 (ie. integer and two decimals).  | 2                          |
|       | Torque                         | The scaling is defined by parameter <a href="#">46.03 Torque scaling</a> .   | 3                          |
|       | Speed                          | The scaling is defined by parameter <a href="#">46.01 Speed scaling</a> .  | 4                          |
|       | Frequency                      | The scaling is defined by parameter <a href="#">46.02 Frequency scaling</a> .  | 5                          |
| 58.27 | <i>EFB ref2 type</i>           | Selects the type and scaling of reference 2 received through the embedded fieldbus interface. The scaled reference is displayed by <a href="#">03.10 EFB reference 2</a> . For the selections, see parameter <a href="#">58.26 EFB ref1 type</a> .   | <a href="#">Torque</a>     |

| No.   | Name/Value                                | Description   | Def/FbEq16          |
|-------|---|---|---------------------|
| 58.28 | <i>EFB act1 type</i>                      | Selects the type/source and scaling of actual value 1 transmitted to the fieldbus network through the embedded fieldbus interface.  | <i>Auto</i>         |
|       | Auto                                      | Type/source and scaling follow the type of reference 1 selected by parameter <i>58.26 EFB ref1 type</i> . See the individual settings below for the sources and scalings. | 0                   |
|       | Transparent                               | The value selected by parameter <i>58.31 EFB act1 transparent source</i> is sent as actual value 1. No scaling is applied (the 16-bit scaling is 1 = 1 unit).             | 1                   |
|       | General                                   | The value selected by parameter <i>58.31 EFB act1 transparent source</i> is sent as actual value 1 with a 16-bit scaling of 100 = 1 unit (ie. integer and two decimals).  | 2                   |
|       | Torque                                    | <i>01.10 Motor torque</i> is sent as actual value 1. The scaling is defined by parameter <i>46.03 Torque scaling</i> .  | 3                   |
|       | Speed                                     | <i>01.01 Motor speed used</i> is sent as actual value 1. The scaling is defined by parameter <i>46.01 Speed scaling</i> .   | 4                   |
|       | Frequency                                 | <i>01.06 Output frequency</i> is sent as actual value 1. The scaling is defined by parameter <i>46.02 Frequency scaling</i> .   | 5                   |
|       | Position                                  | Motor position is sent as actual value 1. See parameter <i>90.06 Motor position scaled</i> .  | 6                   |
| 58.29 | <i>EFB act2 type</i>                      | Selects the type/source and scaling of actual value 2 transmitted to the fieldbus network through the embedded fieldbus interface.  | <i>Torque</i>       |
|       | Auto                                      | Type/source and scaling follow the type of reference 2 selected by parameter <i>58.27 EFB ref2 type</i> . See the individual settings below for the sources and scalings. | 0                   |
|       | Transparent                               | The value selected by parameter <i>58.32 EFB act2 transparent source</i> is sent as actual value 2. No scaling is applied (the 16-bit scaling is 1 = 1 unit).             | 1                   |
|       | General                                   | The value selected by parameter <i>58.32 EFB act2 transparent source</i> is sent as actual value 2 with a 16-bit scaling of 100 = 1 unit (ie. integer and two decimals).  | 2                   |
|       | Torque                                    | <i>01.10 Motor torque</i> is sent as actual value 2. The scaling is defined by parameter <i>46.03 Torque scaling</i> .  | 3                   |
|       | Speed                                     | <i>01.01 Motor speed used</i> is sent as actual value 2. The scaling is defined by parameter <i>46.01 Speed scaling</i> .   | 4                   |
|       | Frequency                                 | <i>01.06 Output frequency</i> is sent as actual value 2. The scaling is defined by parameter <i>46.02 Frequency scaling</i> .   | 5                   |
|       | Position                                  | Motor position is sent as actual value 2. See parameter <i>90.06 Motor position scaled</i> .  | 6                   |
| 58.30 | <i>EFB status word transparent source</i> | Selects the source of the status word when <i>58.25 Control profile</i> is set to <i>Transparent</i> .  | <i>Not selected</i> |
|       | Not selected                              | None.   | 0                   |
|       | <i>Other</i>                              | Source selection (see <i>Terms and abbreviations</i> on page 112).  | -                   |
| 58.31 | <i>EFB act1 transparent source</i>        | Selects the source of actual value 1 when <i>58.28 EFB act1 type</i> is set to <i>Transparent</i> or <i>General</i> .   | <i>Not selected</i> |
|       | Not selected                              | None.   | 0                   |
|       | <i>Other</i>                              | Source selection (see <i>Terms and abbreviations</i> on page 112).  | -                   |





## 352 Parameters

| No.                    | Name/Value                 | Description  | Def/FbEq16                 |
|------------------------|----------------------------|--|----------------------------|
| <a href="#">58.101</a> | <a href="#">Data I/O 1</a> | Defines the address in the drive which the Modbus master accesses when it reads from or writes to register address 400001.<br>The master defines the type of the data (input or output). The value is transmitted in a Modbus frame consisting of two 16-bit words. If the value is 16-bit, it is transmitted in the LSW (least significant word). If the value is 32-bit, the subsequent parameter is also reserved for it and must be set to <i>None</i> . | <a href="#">CW 16bit</a>   |
|                        | None                       | None.  | 0                          |
|                        | CW 16bit                   | Control Word (16 bits).  | 1                          |
|                        | Ref1 16bit                 | Reference REF1 (16 bits).  | 2                          |
|                        | Ref2 16bit                 | Reference REF2 (16 bits).  | 3                          |
|                        | SW 16bit                   | Status Word (16 bits).   | 4                          |
|                        | Act1 16bit                 | Actual value ACT1 (16 bits).   | 5                          |
|                        | Act2 16bit                 | Actual value ACT2 (16 bits).   | 6                          |
|                        | CW 32bit                   | Control Word (32 bits).  | 11                         |
|                        | Ref1 32bit                 | Reference REF1 (32 bits).  | 12                         |
|                        | Ref2 32bit                 | Reference REF2 (32 bits).  | 13                         |
|                        | SW 32bit                   | Status Word (32 bits).   | 14                         |
|                        | Act1 32bit                 | Actual value ACT1 (32 bits).   | 15                         |
|                        | Act2 32bit                 | Actual value ACT2 (32 bits).   | 16                         |
|                        | CW2 16bit                  | Control Word 2 (16 bits).<br>When a 32-bit control word is used, this setting means the most-significant 16 bits.  | 21                         |
|                        | SW2 16bit                  | Status Word 2 (16 bits).<br>When a 32-bit control word is used, this setting means the most-significant 16 bits.   | 24                         |
|                        | RO/DIO control word        | Parameter <a href="#">10.99 RO/DIO control word</a> .  | 31                         |
|                        | AO1 data storage           | Parameter <a href="#">13.91 AO1 data storage</a> .   | 32                         |
|                        | AO2 data storage           | Parameter <a href="#">13.92 AO2 data storage</a> .   | 33                         |
|                        | Feedback data storage      | Parameter <a href="#">40.91 Feedback data storage</a> .  | 40                         |
|                        | Setpoint data storage      | Parameter <a href="#">40.92 Setpoint data storage</a> .  | 41                         |
|                        | <i>Other</i>               | Source selection (see <a href="#">Terms and abbreviations</a> on page 112).  | -                          |
| <a href="#">58.102</a> | <a href="#">Data I/O 2</a> | Defines the address in the drive which the Modbus master accesses when it reads from or writes to register address 400002.<br>For the selections, see parameter <a href="#">58.101 Data I/O 1</a> .  | <a href="#">Ref1 16bit</a> |
| <a href="#">58.103</a> | <a href="#">Data I/O 3</a> | Defines the address in the drive which the Modbus master accesses when it reads from or writes to register address 400003.<br>For the selections, see parameter <a href="#">58.101 Data I/O 1</a> .  | <a href="#">Ref2 16bit</a> |
| <a href="#">58.104</a> | <a href="#">Data I/O 4</a> | Defines the address in the drive which the Modbus master accesses when it reads from or writes to register address 400004.<br>For the selections, see parameter <a href="#">58.101 Data I/O 1</a> .  | <a href="#">SW 16bit</a>   |



| No.                          | Name/Value             | Description   | Def/FbEq16 |
|------------------------------|------------------------|---|------------|
| 58.105                       | Data I/O 5             | Defines the address in the drive which the Modbus master accesses when it reads from or writes to register address 400005.<br>For the selections, see parameter <a href="#">58.101 Data I/O 1</a> .   | Act1 16bit |
| 58.106                       | Data I/O 6             | Defines the address in the drive which the Modbus master accesses when it reads from or writes to register address 400006.<br>For the selections, see parameter <a href="#">58.101 Data I/O 1</a> .   | Act2 16bit |
| 58.107                       | Data I/O 7             | Parameter selector for Modbus register address 400007.<br>For the selections, see parameter <a href="#">58.101 Data I/O 1</a> .   | None       |
| ...                          | ...                    | ...   | ...        |
| 58.124                       | Data I/O 24            | Parameter selector for Modbus register address 400024.<br>For the selections, see parameter <a href="#">58.101 Data I/O 1</a> .   | None       |
| <b>60 DDCS communication</b> |                        |   |            |
| <b>60 DDCS communication</b> |                        | DDCS communication configuration.<br>The DDCS protocol is used in the communication between <ul style="list-style-type: none"> <li>drives in a master/follower configuration (see page 31),</li> <li>the drive and an external controller such as the AC 800M (see page 38), or</li> <li>the drive (or more precisely, an inverter unit) and the supply unit of the drive system (see page 40).</li> </ul> All of the above utilize a fiber optic link which also requires an FDCO module (typically with ZCU control units) or an RDCO module (with BCU control units). Master/follower and external controller communication can also be implemented through shielded twisted-pair cable connected to the XD2D connector of the drive.<br>This group also contains parameters for drive-to-drive (D2D) communication supervision. |            |
| 60.01                        | M/F communication port | Selects the connection used by the master/follower functionality.   | Not in use |
|                              | Not in use             | None (communication disabled).  | 0          |
|                              | Slot 1A                | Channel A on FDCO module in slot 1 (with ZCU control unit only).  | 1          |
|                              | Slot 2A                | Channel A on FDCO module in slot 2 (with ZCU control unit only).  | 2          |
|                              | Slot 3A                | Channel A on FDCO module in slot 3 (with ZCU control unit only).  | 3          |
|                              | Slot 1B                | Channel B on FDCO module in slot 1 (with ZCU control unit only).  | 4          |
|                              | Slot 2B                | Channel B on FDCO module in slot 2 (with ZCU control unit only).  | 5          |
|                              | Slot 3B                | Channel B on FDCO module in slot 3 (with ZCU control unit only).  | 6          |
|                              | RDCO CH 2              | Channel 2 on RDCO module (with BCU control unit only).  | 12         |
|                              | XD2D                   | Connector XD2D.<br><b>Note:</b> This connection cannot co-exist, and is not to be confused with, drive-to-drive (D2D) communication implemented by application programming (detailed in <i>Drive application programming manual (IEC 61131-3)</i> , 3AUA0000127808 [English]).  | 7          |

| No.   | Name/Value               | Description  | Def/FbEq16        |
|-------|--------------------------|--|-------------------|
| 60.02 | <i>M/F node address</i>  | Selects the node address of the drive for master/follower communication. No two nodes on-line may have the same address.<br><b>Note:</b> The allowable addresses for the master are 0 and 1. The allowable addresses for followers are 2...60.   | 1                 |
|       | 1...254                  | Node address.  |                   |
| 60.03 | <i>M/F mode</i>          | Defines the role of the drive on the master/follower or drive-to-drive link.   | <i>Not in use</i> |
|       | Not in use               | Master/follower functionality not active.  | 0                 |
|       | DDCS master              | The drive is the master on the master/follower (DDCS) link.  | 1                 |
|       | DDCS follower            | The drive is a follower on the master/follower (DDCS) link.  | 2                 |
|       | D2D master               | The drive is the master on the drive-to-drive (D2D) link.<br><b>Note:</b> This setting is only to be used with D2D communication implemented by application programming. If you are using the master/follower functionality (see page 31) through the XD2D connector, select <i>DDCS master</i> instead.   | 3                 |
|       | D2D follower             | The drive is a follower on the drive-to-drive (D2D) link.<br><b>Note:</b> This setting is only to be used with D2D communication implemented by application programming. If you are using the master/follower functionality (see page 31) through the XD2D connector, select <i>DDCS follower</i> instead.   | 4                 |
|       | DDCS forcing             | The role of the drive on the master/follower (DDCS) link is defined by parameters <i>60.15 Force master</i> and <i>60.16 Force follower</i> .  | 5                 |
|       | D2D forcing              | The role of the drive on the drive-to-drive (D2D) link is defined by parameters <i>60.15 Force master</i> and <i>60.16 Force follower</i> .<br><b>Note:</b> This setting is only to be used with D2D communication implemented by application programming. If you are using the master/follower functionality (see page 31) through the XD2D connector, select <i>DDCS forcing</i> instead.  | 6                 |
| 60.05 | <i>M/F HW connection</i> | Selects the topology of the master/follower link.<br><b>Note:</b> Use the setting <i>Star</i> if using the master/follower functionality (see page 31) through the XD2D connector (as opposed to a fiber optic link).  | <i>Ring</i>       |
|       | Ring                     | The devices are connected in a ring topology. Forwarding of messages is enabled.   | 0                 |
|       | Star                     | The devices are connected in a star topology (for example, through a branching unit). Forwarding of messages is disabled.  | 1                 |
| 60.07 | <i>M/F link control</i>  | Defines the light intensity of the transmission LED of RDCO module channel CH2. (This parameter is effective only when parameter <i>60.01 M/F communication port</i> is set to <i>RDCO CH 2</i> . FDCO modules have a hardware transmitter current selector.)<br>In general, use higher values with longer fiber optic cables. The maximum setting is applicable to the maximum length of the fiber optic link. See <i>Specifications of the fiber optic master/follower link</i> (page 37). | 10                |
|       | 1...15                   | Light intensity.   |                   |

| No.   | Name/Value                    | Description  | Def/FbEq16    |
|-------|-------------------------------|--|---------------|
| 60.08 | <i>M/F comm loss timeout</i>  | Sets a timeout for master/follower (DDCS) communication. If a communication break lasts longer than the timeout, the action specified by parameter <i>60.09 M/F comm loss function</i> is taken.<br>As a rule of thumb, this parameter should be set to at least 3 times the transmit interval of the master.  | 100 ms        |
|       | 0...65535 ms                  | Master/follower communication timeout.   |               |
| 60.09 | <i>M/F comm loss function</i> | Selects how the drive reacts to a master/follower communication break.   | <i>Fault</i>  |
|       | No action                     | No action taken.   | 0             |
|       | Warning                       | The drive generates an <i>A7CB MF comm loss</i> warning. This only occurs if control is expected from the master/follower link, or if supervision is forced using parameter <i>60.32 M/F comm supervision force</i> .<br> <b>WARNING!</b> Make sure that it is safe to continue operation in case of a communication break. | 1             |
|       | Fault                         | Drive trips on <i>7582 MF comm loss</i> . This only occurs if control is expected from the master/follower link, or if supervision is forced using parameter <i>60.32 M/F comm supervision force</i> .   | 2             |
|       | Fault always                  | Drive trips on <i>7582 MF comm loss</i> . This occurs even though no control is expected from the master/follower link.  | 3             |
| 60.10 | <i>M/F ref1 type</i>          | Selects the type and scaling of reference 1 received from the master/follower link. The resulting value is shown by <i>03.13 M/F or D2D ref1</i> .   | <i>Auto</i>   |
|       | Auto                          | Type and scaling are chosen automatically according to which reference chain (see settings <i>Torque, Speed, Frequency</i> ) the incoming reference is connected to. If the reference is not connected to any chain, no scaling is applied (as with setting <i>Transparent</i> ).  | 0             |
|       | Transparent                   | No scaling is applied.   | 1             |
|       | General                       | Generic reference with a scaling of 100 = 1 (ie. integer and two decimals).  | 2             |
|       | Torque                        | The scaling is defined by parameter <i>46.03 Torque scaling</i> .  | 3             |
|       | Speed                         | The scaling is defined by parameter <i>46.01 Speed scaling</i> .   | 4             |
|       | Frequency                     | The scaling is defined by parameter <i>46.02 Frequency scaling</i> .   | 5             |
| 60.11 | <i>M/F ref2 type</i>          | Selects the type and scaling of reference 2 received from the master/follower link. The resulting value is shown by <i>03.14 M/F or D2D ref2</i> .<br>For the selections, see parameter <i>60.10 M/F ref1 type</i> .   | <i>Torque</i> |
| 60.12 | <i>M/F act1 type</i>          | Selects the type/source and scaling of actual value ACT1 transmitted to the master/follower link.  | <i>Auto</i>   |
|       | Auto                          | Type/source and scaling follow the type of reference 1 selected by parameter <i>60.10 M/F ref1 type</i> . See the individual settings below for the sources and scalings.  | 0             |
|       | Transparent                   | Reserved.  | 1             |
|       | General                       | Reserved.  | 2             |
|       | Torque                        | <i>01.10 Motor torque</i> is sent as actual value 1. The scaling is defined by parameter <i>46.03 Torque scaling</i> .   | 3             |
|       | Speed                         | <i>01.01 Motor speed used</i> is sent as actual value 1. The scaling is defined by parameter <i>46.01 Speed scaling</i> .  | 4             |

| No.          | Name/Value                           | Description  | Def/FbEq16   |
|--------------|--------------------------------------|--|--------------|
|              | Frequency                            | <a href="#">01.06 Output frequency</a> is sent as actual value 1. The scaling is defined by parameter <a href="#">46.02 Frequency scaling</a> .  | 5            |
| <b>60.13</b> | <b><i>M/F act2 type</i></b>          | Selects the type/source and scaling of actual value ACT2 transmitted to the master/follower link.  | <i>Auto</i>  |
|              | Auto                                 | Type/source and scaling follow the type of reference 2 selected by parameter <a href="#">60.11 M/F ref2 type</a> . See the individual settings below for the sources and scalings.   | 0            |
|              | Transparent                          | Reserved.  | 1            |
|              | General                              | Reserved.  | 2            |
|              | Torque                               | <a href="#">01.10 Motor torque</a> is sent as actual value 2. The scaling is defined by parameter <a href="#">46.03 Torque scaling</a> .   | 3            |
|              | Speed                                | <a href="#">01.01 Motor speed used</a> is sent as actual value 2. The scaling is defined by parameter <a href="#">46.01 Speed scaling</a> .  | 4            |
|              | Frequency                            | <a href="#">01.06 Output frequency</a> is sent as actual value 2. The scaling is defined by parameter <a href="#">46.02 Frequency scaling</a> .  | 5            |
| <b>60.14</b> | <b><i>M/F follower selection</i></b> | (Effective in the master only.) Defines the followers from which data is read. See also parameters <a href="#">62.28...62.33</a> .   | <i>None</i>  |
|              | Follower node 2                      | Data is read from the follower with node address 2.  | 2            |
|              | Follower node 3                      | Data is read from the follower with node address 3.  | 4            |
|              | Follower node 4                      | Data is read from the follower with node address 4.  | 8            |
|              | Follower nodes 2+3                   | Data is read from the followers with node addresses 2 and 3.   | 6            |
|              | Follower nodes 2+4                   | Data is read from the followers with node addresses 2 and 4.   | 10           |
|              | Follower nodes 3+4                   | Data is read from the followers with node addresses 3 and 4.   | 12           |
|              | Follower nodes 2+3+4                 | Data is read from the followers with node addresses 2, 3 and 4.  | 14           |
|              | None                                 | None.  | 0            |
| <b>60.15</b> | <b><i>Force master</i></b>           | When parameter <a href="#">60.03 M/F mode</a> is set to <i>DDCS forcing</i> or <i>D2D forcing</i> , this parameter selects a source that forces the drive to be the master on the master/follower link.<br>1 = Drive is master on the master/follower link   | <i>FALSE</i> |
|              | FALSE                                | 0.   | 0            |
|              | TRUE                                 | 1.   | 1            |
|              | <i>Other [bit]</i>                   | Source selection (see <a href="#">Terms and abbreviations</a> on page 112).  | -            |
| <b>60.16</b> | <b><i>Force follower</i></b>         | When parameter <a href="#">60.03 M/F mode</a> is set to <i>DDCS forcing</i> or <i>D2D forcing</i> , this parameter selects a source that forces the drive to be a follower on the master/follower link.<br>1 = Drive is follower on the master/follower link | <i>FALSE</i> |
|              | FALSE                                | 0.   | 0            |
|              | TRUE                                 | 1.   | 1            |
|              | <i>Other [bit]</i>                   | Source selection (see <a href="#">Terms and abbreviations</a> on page 112).  | -            |

| No.   | Name/Value                   | Description  | Def/FbEq16    |
|-------|------------------------------|--|---------------|
| 60.17 | <i>Follower fault action</i> | (Effective in the master only.) Selects how the drive reacts to a fault in a follower.<br>See also parameter <i>60.23 M/F status supervision sel 1</i> .<br><b>Note:</b> Each follower must be configured to transmit its status word as one of the three data words in parameters <i>61.01...61.03</i> . In the master, the corresponding target parameter ( <i>62.04...62.12</i> ) must be set to <i>Follower SW</i> . | <i>Fault</i>  |
|       | No action                    | No action taken. Unaffected drives on the master/follower link will continue running.  | 0             |
|       | Warning                      | The drive generates a warning ( <i>AFE7 Follower</i> ).  | 1             |
|       | Fault                        | Drive trips on <i>FF7E Follower</i> . All followers will be stopped.   | 2             |
| 60.18 | <i>Follower enable</i>       | Interlocks the starting of the master to the status of the followers.<br>See also parameter <i>60.23 M/F status supervision sel 1</i> .<br><b>Note:</b> Each follower must be configured to transmit its status word as one of the three data words in parameters <i>61.01...61.03</i> . In the master, the corresponding target parameter ( <i>62.04...62.12</i> ) must be set to <i>Follower SW</i> .                  | <i>Always</i> |
|       | MSW bit 0                    | The master can only be started if all followers are ready to switch on (bit 0 of <i>06.11 Main status word</i> in each follower is on).  | 0             |
|       | MSW bit 1                    | The master can only be started if all followers are ready to operate (bit 1 of <i>06.11 Main status word</i> in each follower is on).  | 1             |
|       | MSW bits 0 + 1               | The master can only be started if all followers are ready to switch on and ready to operate (bits 0 and 1 of <i>06.11 Main status word</i> in each follower are on).   | 2             |
|       | Always                       | The starting of the master is not interlocked to the status of the followers.  | 3             |
|       | MSW bit 12                   | The master can only be started if user-definable bit 12 of <i>06.11 Main status word</i> in each follower is on. See parameter <i>06.31 MSW bit 12 sel</i> .   | 4             |
|       | MSW bits 0 + 12              | The master can only be started if both bit 0 and bit 12 of <i>06.11 Main status word</i> in each follower are on.  | 5             |
|       | MSW bits 1 + 12              | The master can only be started if both bit 1 and bit 12 of <i>06.11 Main status word</i> in each follower are on.  | 6             |

| No.           | Name/Value                        | Description  | Def/FbEq16 |      |             |   |             |  |   |             |  |     |     |     |    |             |  |  |
|---------------|-----------------------------------|--|------------|------|-------------|---|-------------|--|---|-------------|--|-----|-----|-----|----|-------------|--|--|
| 60.19         | <i>M/F comm supervision sel 1</i> | <p>Parameters 60.19...60.28 are only effective when the drive is the master on a D2D (drive-to-drive) link, implemented by application programming. See parameters 60.01 <i>M/F communication port</i> and 60.03 <i>M/F mode</i>, and <i>Drive (IEC 61131-3) application programming manual</i> (3AUA0000127808 [English]).</p> <p>In the master, parameters 60.19 <i>M/F comm supervision sel 1</i> and 60.20 <i>M/F comm supervision sel 2</i> specify the followers that are monitored for loss of communication.</p> <p>This parameter selects which followers (out of followers 1...16) are monitored. Each of the selected followers is polled by the master. If no reply is received, the action specified in 60.09 <i>M/F comm loss function</i> is taken.</p> <p>The status of communication is shown by 62.37 <i>M/F communication status 1</i> and 62.38 <i>M/F communication status 2</i>.</p> | -          |      |             |   |             |  |   |             |  |     |     |     |    |             |  |  |
|               |                                   | <table border="1"> <thead> <tr> <th>Bit</th> <th>Name</th> <th>Description</th> </tr> </thead> <tbody> <tr> <td>0</td> <td>Follower 1</td> <td>1 = Follower 1 is polled by the master.</td> </tr> <tr> <td>1</td> <td>Follower 2</td> <td>1 = Follower 2 is polled by the master.</td> </tr> <tr> <td>...</td> <td>...</td> <td>...</td> </tr> <tr> <td>15</td> <td>Follower 16</td> <td>1 = Follower 16 is polled by the master.</td> </tr> </tbody> </table>   | Bit        | Name | Description | 0 | Follower 1  | 1 = Follower 1 is polled by the master.  | 1 | Follower 2  | 1 = Follower 2 is polled by the master.  | ... | ... | ... | 15 | Follower 16 | 1 = Follower 16 is polled by the master. |  |
| Bit           | Name                              | Description  |            |      |             |   |             |  |   |             |  |     |     |     |    |             |  |  |
| 0             | Follower 1                        | 1 = Follower 1 is polled by the master.  |            |      |             |   |             |  |   |             |  |     |     |     |    |             |  |  |
| 1             | Follower 2                        | 1 = Follower 2 is polled by the master.  |            |      |             |   |             |  |   |             |  |     |     |     |    |             |  |  |
| ...           | ...                               | ...  |            |      |             |   |             |  |   |             |  |     |     |     |    |             |  |  |
| 15            | Follower 16                       | 1 = Follower 16 is polled by the master.   |            |      |             |   |             |  |   |             |  |     |     |     |    |             |  |  |
| 0000h...FFFFh |                                   | Selection of followers for D2D communication supervision (1).  | 1 = 1      |      |             |   |             |  |   |             |  |     |     |     |    |             |  |  |
| 60.20         | <i>M/F comm supervision sel 2</i> | <p>Selects which followers (out of followers 17...32) are monitored for loss of communication. See parameter 60.19 <i>M/F comm supervision sel 1</i>.</p>  | -          |      |             |   |             |  |   |             |  |     |     |     |    |             |  |  |
|               |                                   | <table border="1"> <thead> <tr> <th>Bit</th> <th>Name</th> <th>Description</th> </tr> </thead> <tbody> <tr> <td>0</td> <td>Follower 17</td> <td>1 = Follower 17 is polled by the master.</td> </tr> <tr> <td>1</td> <td>Follower 18</td> <td>1 = Follower 18 is polled by the master.</td> </tr> <tr> <td>...</td> <td>...</td> <td>...</td> </tr> <tr> <td>15</td> <td>Follower 32</td> <td>1 = Follower 32 is polled by the master.</td> </tr> </tbody> </table>   | Bit        | Name | Description | 0 | Follower 17 | 1 = Follower 17 is polled by the master. | 1 | Follower 18 | 1 = Follower 18 is polled by the master. | ... | ... | ... | 15 | Follower 32 | 1 = Follower 32 is polled by the master. |  |
| Bit           | Name                              | Description  |            |      |             |   |             |  |   |             |  |     |     |     |    |             |  |  |
| 0             | Follower 17                       | 1 = Follower 17 is polled by the master.   |            |      |             |   |             |  |   |             |  |     |     |     |    |             |  |  |
| 1             | Follower 18                       | 1 = Follower 18 is polled by the master.   |            |      |             |   |             |  |   |             |  |     |     |     |    |             |  |  |
| ...           | ...                               | ...  |            |      |             |   |             |  |   |             |  |     |     |     |    |             |  |  |
| 15            | Follower 32                       | 1 = Follower 32 is polled by the master.   |            |      |             |   |             |  |   |             |  |     |     |     |    |             |  |  |
| 0000h...FFFFh |                                   | Selection of followers for D2D communication supervision (2).  | 1 = 1      |      |             |   |             |  |   |             |  |     |     |     |    |             |  |  |



| No.   | Name/Value                          | Description   | Def/FbEq16 |     |      |             |   |             |   |   |             |   |     |     |     |    |             |   |
|---|-------------------------------------|---|------------|-----|------|-------------|---|-------------|---|---|-------------|---|-----|-----|-----|----|-------------|---|
| 60.23   | <i>M/F status supervision sel 1</i> | <p>(This parameter is only effective when the drive is the master on a D2D link. See parameters <a href="#">60.01 M/F communication port</a> and <a href="#">60.03 M/F mode</a>.)</p> <p>In the master, parameters <a href="#">60.23 M/F status supervision sel 1</a> and <a href="#">60.24 M/F status supervision sel 2</a> specify the followers whose status word is monitored by the master.</p> <p>This parameter selects the followers (out of followers 1...16) whose status words are monitored by the master.</p> <p>If a follower reports a fault (bit 3 of the status word is on), the action specified in <a href="#">60.17 Follower fault action</a> is taken. Bits 0 and 1 of the status word (ready states) are handled as defined by <a href="#">60.18 Follower enable</a>.</p> <p>Using <a href="#">60.27 M/F status supv mode sel 1</a> and <a href="#">60.28 M/F status supv mode sel 2</a>, it is possible to define whether any given follower is only monitored when it is stopped.</p> <p><b>Note:</b> Also activate communication supervision for the same followers in parameter <a href="#">60.19 M/F comm supervision sel 1</a>.</p> <p>The status of communication is shown by <a href="#">62.37 M/F communication status 1</a> and <a href="#">62.38 M/F communication status 2</a>.</p> | -          |     |      |             |   |             |   |   |             |   |     |     |     |    |             |   |
| <table border="1"> <thead> <tr> <th>Bit</th> <th>Name</th> <th>Description</th> </tr> </thead> <tbody> <tr> <td>0</td> <td>Follower 1</td> <td>1 = Status of follower 1 is monitored.</td> </tr> <tr> <td>1</td> <td>Follower 2</td> <td>1 = Status of follower 2 is monitored.</td> </tr> <tr> <td>...</td> <td>...</td> <td>...</td> </tr> <tr> <td>15</td> <td>Follower 16</td> <td>1 = Status of follower 16 is monitored.</td> </tr> </tbody> </table>     |                                     |   |            | Bit | Name | Description | 0 | Follower 1  | 1 = Status of follower 1 is monitored.  | 1 | Follower 2  | 1 = Status of follower 2 is monitored.  | ... | ... | ... | 15 | Follower 16 | 1 = Status of follower 16 is monitored. |
| Bit   | Name                                | Description   |            |     |      |             |   |             |   |   |             |   |     |     |     |    |             |   |
| 0   | Follower 1                          | 1 = Status of follower 1 is monitored.  |            |     |      |             |   |             |   |   |             |   |     |     |     |    |             |   |
| 1   | Follower 2                          | 1 = Status of follower 2 is monitored.  |            |     |      |             |   |             |   |   |             |   |     |     |     |    |             |   |
| ...   | ...                                 | ...   |            |     |      |             |   |             |   |   |             |   |     |     |     |    |             |   |
| 15  | Follower 16                         | 1 = Status of follower 16 is monitored.   |            |     |      |             |   |             |   |   |             |   |     |     |     |    |             |   |
| 0000h...FFFFh   |                                     | D2D follower status supervision selection (followers 1...16).   | 1 = 1      |     |      |             |   |             |   |   |             |   |     |     |     |    |             |   |
| 60.24   | <i>M/F status supervision sel 2</i> | <p>Selects the followers (out of followers 17...32) whose status words are monitored by the D2D master.</p> <p><b>Note:</b> Also activate communication supervision for the same followers in parameter <a href="#">60.20 M/F comm supervision sel 2</a>. See parameter <a href="#">60.23 M/F status supervision sel 1</a>.</p>   | -          |     |      |             |   |             |   |   |             |   |     |     |     |    |             |   |
| <table border="1"> <thead> <tr> <th>Bit</th> <th>Name</th> <th>Description</th> </tr> </thead> <tbody> <tr> <td>0</td> <td>Follower 17</td> <td>1 = Status of follower 17 is monitored.</td> </tr> <tr> <td>1</td> <td>Follower 18</td> <td>1 = Status of follower 18 is monitored.</td> </tr> <tr> <td>...</td> <td>...</td> <td>...</td> </tr> <tr> <td>15</td> <td>Follower 32</td> <td>1 = Status of follower 32 is monitored.</td> </tr> </tbody> </table> |                                     |   |            | Bit | Name | Description | 0 | Follower 17 | 1 = Status of follower 17 is monitored. | 1 | Follower 18 | 1 = Status of follower 18 is monitored. | ... | ... | ... | 15 | Follower 32 | 1 = Status of follower 32 is monitored. |
| Bit   | Name                                | Description   |            |     |      |             |   |             |   |   |             |   |     |     |     |    |             |   |
| 0   | Follower 17                         | 1 = Status of follower 17 is monitored.   |            |     |      |             |   |             |   |   |             |   |     |     |     |    |             |   |
| 1   | Follower 18                         | 1 = Status of follower 18 is monitored.   |            |     |      |             |   |             |   |   |             |   |     |     |     |    |             |   |
| ...   | ...                                 | ...   |            |     |      |             |   |             |   |   |             |   |     |     |     |    |             |   |
| 15  | Follower 32                         | 1 = Status of follower 32 is monitored.   |            |     |      |             |   |             |   |   |             |   |     |     |     |    |             |   |
| 0000h...FFFFh   |                                     | D2D follower status supervision selection (followers 17...32).  | 1 = 1      |     |      |             |   |             |   |   |             |   |     |     |     |    |             |   |

| No.   | Name/Value                        | Description   | Def/FbEq16 |     |      |             |   |             |  |   |             |  |     |     |     |    |             |  |
|---|-----------------------------------|---|------------|-----|------|-------------|---|-------------|--|---|-------------|--|-----|-----|-----|----|-------------|--|
| 60.27   | <i>M/F status supv mode sel 1</i> | In the D2D master, parameters <i>60.27 M/F status supv mode sel 1</i> and <i>60.28 M/F status supv mode sel 2</i> specify the mode of follower status word monitoring. Each follower can individually be set to be monitored continuously, or only when it is in stopped state.<br>This parameter selects the mode of status word monitoring of followers 1...16. | -          |     |      |             |   |             |  |   |             |  |     |     |     |    |             |  |
| <table border="1"> <thead> <tr> <th>Bit</th> <th>Name</th> <th>Description</th> </tr> </thead> <tbody> <tr> <td>0</td> <td>Follower 1</td> <td>0 = Status of follower 1 is monitored continuously.<br/>1 = Status of follower 1 is monitored only when it is in stopped state.</td> </tr> <tr> <td>1</td> <td>Follower 2</td> <td>0 = Status of follower 2 is monitored continuously.<br/>1 = Status of follower 2 is monitored only when it is in stopped state.</td> </tr> <tr> <td>...</td> <td>...</td> <td>...</td> </tr> <tr> <td>15</td> <td>Follower 16</td> <td>0 = Status of follower 16 is monitored continuously.<br/>1 = Status of follower 16 is monitored only when it is in stopped state.</td> </tr> </tbody> </table>       |                                   |   |            | Bit | Name | Description | 0 | Follower 1  | 0 = Status of follower 1 is monitored continuously.<br>1 = Status of follower 1 is monitored only when it is in stopped state.   | 1 | Follower 2  | 0 = Status of follower 2 is monitored continuously.<br>1 = Status of follower 2 is monitored only when it is in stopped state.   | ... | ... | ... | 15 | Follower 16 | 0 = Status of follower 16 is monitored continuously.<br>1 = Status of follower 16 is monitored only when it is in stopped state. |
| Bit   | Name                              | Description   |            |     |      |             |   |             |  |   |             |  |     |     |     |    |             |  |
| 0   | Follower 1                        | 0 = Status of follower 1 is monitored continuously.<br>1 = Status of follower 1 is monitored only when it is in stopped state.  |            |     |      |             |   |             |  |   |             |  |     |     |     |    |             |  |
| 1   | Follower 2                        | 0 = Status of follower 2 is monitored continuously.<br>1 = Status of follower 2 is monitored only when it is in stopped state.  |            |     |      |             |   |             |  |   |             |  |     |     |     |    |             |  |
| ...   | ...                               | ...   |            |     |      |             |   |             |  |   |             |  |     |     |     |    |             |  |
| 15  | Follower 16                       | 0 = Status of follower 16 is monitored continuously.<br>1 = Status of follower 16 is monitored only when it is in stopped state.  |            |     |      |             |   |             |  |   |             |  |     |     |     |    |             |  |
| 0000h...FFFFh   |                                   | D2D status supervision mode selection 1.  | 1 = 1      |     |      |             |   |             |  |   |             |  |     |     |     |    |             |  |
| 60.28   | <i>M/F status supv mode sel 2</i> | Selects the mode of status word monitoring of followers 17...32.  | -          |     |      |             |   |             |  |   |             |  |     |     |     |    |             |  |
| <table border="1"> <thead> <tr> <th>Bit</th> <th>Name</th> <th>Description</th> </tr> </thead> <tbody> <tr> <td>0</td> <td>Follower 17</td> <td>0 = Status of follower 17 is monitored continuously.<br/>1 = Status of follower 17 is monitored only when it is in stopped state.</td> </tr> <tr> <td>1</td> <td>Follower 18</td> <td>0 = Status of follower 18 is monitored continuously.<br/>1 = Status of follower 18 is monitored only when it is in stopped state.</td> </tr> <tr> <td>...</td> <td>...</td> <td>...</td> </tr> <tr> <td>15</td> <td>Follower 32</td> <td>0 = Status of follower 32 is monitored continuously.<br/>1 = Status of follower 32 is monitored only when it is in stopped state.</td> </tr> </tbody> </table> |                                   |   |            | Bit | Name | Description | 0 | Follower 17 | 0 = Status of follower 17 is monitored continuously.<br>1 = Status of follower 17 is monitored only when it is in stopped state. | 1 | Follower 18 | 0 = Status of follower 18 is monitored continuously.<br>1 = Status of follower 18 is monitored only when it is in stopped state. | ... | ... | ... | 15 | Follower 32 | 0 = Status of follower 32 is monitored continuously.<br>1 = Status of follower 32 is monitored only when it is in stopped state. |
| Bit   | Name                              | Description   |            |     |      |             |   |             |  |   |             |  |     |     |     |    |             |  |
| 0   | Follower 17                       | 0 = Status of follower 17 is monitored continuously.<br>1 = Status of follower 17 is monitored only when it is in stopped state.  |            |     |      |             |   |             |  |   |             |  |     |     |     |    |             |  |
| 1   | Follower 18                       | 0 = Status of follower 18 is monitored continuously.<br>1 = Status of follower 18 is monitored only when it is in stopped state.  |            |     |      |             |   |             |  |   |             |  |     |     |     |    |             |  |
| ...   | ...                               | ...   |            |     |      |             |   |             |  |   |             |  |     |     |     |    |             |  |
| 15  | Follower 32                       | 0 = Status of follower 32 is monitored continuously.<br>1 = Status of follower 32 is monitored only when it is in stopped state.  |            |     |      |             |   |             |  |   |             |  |     |     |     |    |             |  |
| 0000h...FFFFh   |                                   | D2D status supervision mode selection 2.  | 1 = 1      |     |      |             |   |             |  |   |             |  |     |     |     |    |             |  |
| 60.31   | <i>M/F wake up delay</i>          | Defines a wake-up delay during which no master/follower communication faults or warnings are generated. This is to allow all drives on the master/follower link to power up.<br>The master cannot be started until the delay elapses or all monitored followers are found to be ready.  | 60.0 s     |     |      |             |   |             |  |   |             |  |     |     |     |    |             |  |
| 0.0 ... 180.0 s   |                                   | Master/follower wake-up delay.  | 10 = 1 s   |     |      |             |   |             |  |   |             |  |     |     |     |    |             |  |



| No.   | Name/Value                        | Description   | Def/FbEq16                  |     |      |       |   |       |   |   |       |   |   |       |   |        |          |  |
|---|-----------------------------------|---|-----------------------------|-----|------|-------|---|-------|---|---|-------|---|---|-------|---|--------|----------|--|
| 60.32   | <i>M/F comm supervision force</i> | Activates master/follower communication monitoring separately for each control location (see section <i>Local control vs. external control</i> on page 20).<br>The parameter is primarily intended for monitoring the communication with master or follower when it is connected to the application program and not selected as a control source by drive parameters. | 0000b                       |     |      |       |   |       |   |   |       |   |   |       |   |        |          |  |
| <table border="1"> <thead> <tr> <th>Bit</th> <th>Name</th> <th>Value</th> </tr> </thead> <tbody> <tr> <td>0</td> <td>Ext 1</td> <td>1 = Communication monitoring active when Ext 1 is being used.</td> </tr> <tr> <td>1</td> <td>Ext 2</td> <td>1 = Communication monitoring active when Ext 2 is being used.</td> </tr> <tr> <td>2</td> <td>Local</td> <td>1 = Communication monitoring active when local control is being used.</td> </tr> <tr> <td>3...15</td> <td>Reserved</td> <td></td> </tr> </tbody> </table> |                                   |   |                             | Bit | Name | Value | 0 | Ext 1 | 1 = Communication monitoring active when Ext 1 is being used. | 1 | Ext 2 | 1 = Communication monitoring active when Ext 2 is being used. | 2 | Local | 1 = Communication monitoring active when local control is being used. | 3...15 | Reserved |  |
| Bit   | Name                              | Value   |                             |     |      |       |   |       |   |   |       |   |   |       |   |        |          |  |
| 0   | Ext 1                             | 1 = Communication monitoring active when Ext 1 is being used.   |                             |     |      |       |   |       |   |   |       |   |   |       |   |        |          |  |
| 1   | Ext 2                             | 1 = Communication monitoring active when Ext 2 is being used.   |                             |     |      |       |   |       |   |   |       |   |   |       |   |        |          |  |
| 2   | Local                             | 1 = Communication monitoring active when local control is being used.   |                             |     |      |       |   |       |   |   |       |   |   |       |   |        |          |  |
| 3...15  | Reserved                          |   |                             |     |      |       |   |       |   |   |       |   |   |       |   |        |          |  |
|   | 0000b...0111b                     | Master/follower communication monitoring selection.   | 1 = 1                       |     |      |       |   |       |   |   |       |   |   |       |   |        |          |  |
| 60.41   | <i>Extension adapter com port</i> | Selects the channel used for connecting an optional FEA-xx extension adapter.   | <i>No connect</i>           |     |      |       |   |       |   |   |       |   |   |       |   |        |          |  |
|   | No connect                        | None (communication disabled).  | 0                           |     |      |       |   |       |   |   |       |   |   |       |   |        |          |  |
|   | Slot 1A                           | Channel A on FDCO module in slot 1.   | 1                           |     |      |       |   |       |   |   |       |   |   |       |   |        |          |  |
|   | Slot 2A                           | Channel A on FDCO module in slot 2.   | 2                           |     |      |       |   |       |   |   |       |   |   |       |   |        |          |  |
|   | Slot 3A                           | Channel A on FDCO module in slot 3.   | 3                           |     |      |       |   |       |   |   |       |   |   |       |   |        |          |  |
|   | Slot 1B                           | Channel B on FDCO module in slot 1.   | 4                           |     |      |       |   |       |   |   |       |   |   |       |   |        |          |  |
|   | Slot 2B                           | Channel B on FDCO module in slot 2.   | 5                           |     |      |       |   |       |   |   |       |   |   |       |   |        |          |  |
|   | Slot 3B                           | Channel B on FDCO module in slot 3.   | 6                           |     |      |       |   |       |   |   |       |   |   |       |   |        |          |  |
|   | RDCO CH 3                         | Channel CH 3 on RDCO module (with BCU control unit only).   | 13                          |     |      |       |   |       |   |   |       |   |   |       |   |        |          |  |
| 60.50   | <i>DDCS controller drive type</i> | In ModuleBus communication, defines whether the drive is of the "engineered" or "standard" type.  | <i>ABB engineered drive</i> |     |      |       |   |       |   |   |       |   |   |       |   |        |          |  |
|   | ABB engineered drive              | The drive is an "engineered drive" (data sets 10...25 are used).  | 0                           |     |      |       |   |       |   |   |       |   |   |       |   |        |          |  |
|   | ABB standard drive                | The drive is a "standard drive" (data sets 1...4 are used).   | 1                           |     |      |       |   |       |   |   |       |   |   |       |   |        |          |  |
| 60.51   | <i>DDCS controller comm port</i>  | Selects the DDCS channel used for connecting an external controller (such as an AC 800M).   | <i>Not in use</i>           |     |      |       |   |       |   |   |       |   |   |       |   |        |          |  |
|   | Not in use                        | None (communication disabled).  | 0                           |     |      |       |   |       |   |   |       |   |   |       |   |        |          |  |
|   | Slot 1A                           | Channel A on FDCO module in slot 1.   | 1                           |     |      |       |   |       |   |   |       |   |   |       |   |        |          |  |
|   | Slot 2A                           | Channel A on FDCO module in slot 2.   | 2                           |     |      |       |   |       |   |   |       |   |   |       |   |        |          |  |
|   | Slot 3A                           | Channel A on FDCO module in slot 3.   | 3                           |     |      |       |   |       |   |   |       |   |   |       |   |        |          |  |
|   | Slot 1B                           | Channel B on FDCO module in slot 1.   | 4                           |     |      |       |   |       |   |   |       |   |   |       |   |        |          |  |
|   | Slot 2B                           | Channel B on FDCO module in slot 2.   | 5                           |     |      |       |   |       |   |   |       |   |   |       |   |        |          |  |
|   | Slot 3B                           | Channel B on FDCO module in slot 3.   | 6                           |     |      |       |   |       |   |   |       |   |   |       |   |        |          |  |
|   | RDCO CH 0                         | Channel 0 on RDCO module (with BCU control unit only).  | 10                          |     |      |       |   |       |   |   |       |   |   |       |   |        |          |  |
|   | XD2D                              | Connector XD2D.   | 7                           |     |      |       |   |       |   |   |       |   |   |       |   |        |          |  |

| No.   | Name/Value                           | Description  | Def/FbEq16    |
|-------|--------------------------------------|--|---------------|
| 60.52 | <i>DDCS controller node address</i>  | Selects the node address of the drive for communication with the external controller. No two nodes on-line may have the same address.<br>With an AC 800M (CI858) DriveBus connection, drives must be addressed 1...24.<br>With an AC 80 DriveBus connection, drives must be addressed 1...12.<br>With optical ModuleBus, the drive address is set according to the position value as follows:<br>1. Multiply the hundreds of the position value by 16.<br>2. Add the tens and ones of the position value to the result.<br>For example, if the position value is 101, this parameter must be set to $1 \times 16 + 1 = 17$ . | 1             |
|       | 1...254                              | Node address.  |               |
| 60.55 | <i>DDCS controller HW connection</i> | Selects the topology of the fiber optic link with an external controller.  | <i>Star</i>   |
|       | Ring                                 | The devices are connected in a ring topology. Forwarding of messages is enabled.   | 0             |
|       | Star                                 | The devices are connected in a star topology (for example, through a branching unit). Forwarding of messages is disabled.  | 1             |
| 60.56 | <i>DDCS controller baud rate</i>     | Selects the communication speed of the channel selected by parameter <i>60.51 DDCS controller comm port</i> .  | <i>4 mbps</i> |
|       | 1 mbps                               | 1 megabit/second.  | 1             |
|       | 2 mbps                               | 2 megabit/second.  | 2             |
|       | 4 mbps                               | 4 megabit/second.  | 4             |
|       | 8 mbps                               | 8 megabit/second.  | 8             |
| 60.57 | <i>DDCS controller link control</i>  | Defines the light intensity of the transmission LED of RDCO module channel CH0. (This parameter is effective only when parameter <i>60.51 DDCS controller comm port</i> is set to <i>RDCO CH 0</i> . FDCO modules have a hardware transmitter current selector.)<br>In general, use higher values with longer fiber optic cables. The maximum setting is applicable to the maximum length of the fiber optic link. See <i>Specifications of the fiber optic master/follower link</i> (page 37).  | 10            |
|       | 1...15                               | Light intensity.   |               |

| No.   | Name/Value                                | Description   | Def/FbEq16   |
|-------|---|---|--------------|
| 60.58 | <i>DDCS controller comm loss time</i>     | <p>Sets a timeout for communication with the external controller. If a communication break lasts longer than the timeout, the action specified by parameter <i>60.59 DDCS controller comm loss function</i> is taken.</p> <p>As a rule of thumb, this parameter should be set to at least 3 times the transmit interval of the controller.</p> <p><b>Notes:</b></p> <ul style="list-style-type: none"> <li>• There is a 60-second boot-up delay immediately after power-up. During the delay, the communication break monitoring is disabled (but communication itself can be active).</li> <li>• With an AC 800M controller, the controller detects a communication break immediately but re-establishing the communication is done at 9-second idle intervals. Also note that the sending interval of a data set is not the same as the execution interval of the application task. On ModuleBus, the sending interval is defined by controller parameter <i>Scan Cycle Time</i> (by default, 100 ms).</li> </ul> | 100 ms       |
|       | 0...60000 ms                              | Timeout for communication with external controller.   |              |
| 60.59 | <i>DDCS controller comm loss function</i> | Selects how the drive reacts to a communication break between the drive and the external controller.  | <i>Fault</i> |
|       | No action                                 | No action taken (monitoring disabled).  | 0            |
|       | Fault                                     | Drive trips on <i>7581 DDCS controller comm loss</i> . This only occurs if control is expected from the external controller, or if supervision is forced using parameter <i>60.65 DDCS controller comm supervision force</i> .  | 1            |
|       | Last speed                                | <p>Drive generates an <i>A7CA DDCS controller comm loss</i> warning and freezes the speed to the level the drive was operating at. This only occurs if control is expected from the external controller, or if supervision is forced using parameter <i>60.65 DDCS controller comm supervision force</i>.</p> <p>The speed is determined on the basis of actual speed using 850 ms low-pass filtering.</p> <p> <b>WARNING!</b> Make sure that it is safe to continue operation in case of a communication break.</p>   | 2            |
|       | Speed ref safe                            | <p>Drive generates an <i>A7CA DDCS controller comm loss</i> warning and sets the speed to the speed defined by parameter <i>22.41 Speed ref safe</i> (or <i>28.41 Frequency ref safe</i> when frequency reference is being used). This only occurs if control is expected from the external controller, or if supervision is forced using parameter <i>60.65 DDCS controller comm supervision force</i>.</p> <p> <b>WARNING!</b> Make sure that it is safe to continue operation in case of a communication break.</p>   | 3            |
|       | Fault always                              | Drive trips on <i>7581 DDCS controller comm loss</i> . This occurs even though no control is expected from the external controller.   | 4            |
|       | Warning                                   | <p>Drive generates an <i>A7CA DDCS controller comm loss</i> warning. This only occurs if control is expected from the external controller, or if supervision is forced using parameter <i>60.65 DDCS controller comm supervision force</i>.</p> <p> <b>WARNING!</b> Make sure that it is safe to continue operation in case of a communication break.</p>  | 5            |

## 364 Parameters

| No.   | Name/Value                       | Description   | Def/FbEq16           |
|-------|----------------------------------|---|----------------------|
| 60.60 | <i>DDCS controller ref1 type</i> | Selects the type and scaling of reference 1 received from the external controller. The resulting value is shown by <a href="#">03.11 DDCS controller ref 1</a> .  | <i>Auto</i>          |
|       | Auto                             | Type and scaling are chosen automatically according to which reference chain (see settings <a href="#">Torque</a> , <a href="#">Speed</a> , <a href="#">Frequency</a> ) the incoming reference is connected to. If the reference is not connected to any chain, no scaling is applied (as with setting <a href="#">Transparent</a> ). | 0                    |
|       | Transparent                      | No scaling is applied.  | 1                    |
|       | General                          | Generic reference with a scaling of 100 = 1 (ie. integer and two decimals).   | 2                    |
|       | Torque                           | The scaling is defined by parameter <a href="#">46.03 Torque scaling</a> .  | 3                    |
|       | Speed                            | The scaling is defined by parameter <a href="#">46.01 Speed scaling</a> .   | 4                    |
|       | Frequency                        | The scaling is defined by parameter <a href="#">46.02 Frequency scaling</a> .   | 5                    |
| 60.61 | <i>DDCS controller ref2 type</i> | Selects the type and scaling of reference 2 received from the external controller. The resulting value is shown by <a href="#">03.12 DDCS controller ref 2</a> .<br>For the selections, see parameter <a href="#">60.60 DDCS controller ref1 type</a> .   | <i>Auto</i>          |
| 60.62 | <i>DDCS controller act1 type</i> | Selects the type/source and scaling of actual value ACT1 transmitted to the external controller.  | <i>Auto</i>          |
|       | Auto                             | Type/source and scaling follow the type of reference 1 selected by parameter <a href="#">60.60 DDCS controller ref1 type</a> . See the individual settings below for the sources and scalings.  | 0                    |
|       | Transparent                      | Reserved.   | 1                    |
|       | General                          | Reserved.   | 2                    |
|       | Torque                           | <a href="#">01.10 Motor torque</a> is sent as actual value 1. The scaling is defined by parameter <a href="#">46.03 Torque scaling</a> .  | 3                    |
|       | Speed                            | <a href="#">01.01 Motor speed used</a> is sent as actual value 1. The scaling is defined by parameter <a href="#">46.01 Speed scaling</a> .   | 4                    |
|       | Frequency                        | <a href="#">01.06 Output frequency</a> is sent as actual value 1. The scaling is defined by parameter <a href="#">46.02 Frequency scaling</a> .   | 5                    |
| 60.63 | <i>DDCS controller act2 type</i> | Selects the type/source and scaling of actual value ACT2 transmitted to the external controller.  | <i>Auto</i>          |
|       | Auto                             | Type/source and scaling follow the type of reference 2 selected by parameter <a href="#">60.61 DDCS controller ref2 type</a> . See the individual settings below for the sources and scalings.  | 0                    |
|       | Transparent                      | Reserved.   | 1                    |
|       | General                          | Reserved.   | 2                    |
|       | Torque                           | <a href="#">01.10 Motor torque</a> is sent as actual value 2. The scaling is defined by parameter <a href="#">46.03 Torque scaling</a> .  | 3                    |
|       | Speed                            | <a href="#">01.01 Motor speed used</a> is sent as actual value 2. The scaling is defined by parameter <a href="#">46.01 Speed scaling</a> .   | 4                    |
|       | Frequency                        | <a href="#">01.06 Output frequency</a> is sent as actual value 2. The scaling is defined by parameter <a href="#">46.02 Frequency scaling</a> .   | 5                    |
| 60.64 | <i>Mailbox dataset selection</i> | Selects the pair of data sets used by the mailbox service in the drive/controller communication.<br>See section <a href="#">External controller interface</a> (page 38).  | <i>Dataset 32/33</i> |
|       | Dataset 32/33                    | Data sets 32 and 33.  | 0                    |

| No.   | Name/Value                                    | Description   | Def/FbEq16   |     |      |       |   |       |   |   |       |   |   |       |   |        |          |  |
|---|---|---|--------------|-----|------|-------|---|-------|---|---|-------|---|---|-------|---|--------|----------|--|
|   | Dataset 24/25                                 | Data sets 24 and 25.  | 1            |     |      |       |   |       |   |   |       |   |   |       |   |        |          |  |
| 60.65   | <i>DDCS controller comm supervision force</i> | Activates DDCS controller communication monitoring separately for each control location (see section <i>Local control vs. external control</i> on page 20).<br>The parameter is primarily intended for monitoring the communication with the controller when it is connected to the application program and not selected as a control source by drive parameters.   | 0000b        |     |      |       |   |       |   |   |       |   |   |       |   |        |          |  |
| <table border="1"> <thead> <tr> <th>Bit</th> <th>Name</th> <th>Value</th> </tr> </thead> <tbody> <tr> <td>0</td> <td>Ext 1</td> <td>1 = Communication monitoring active when Ext 1 is being used.</td> </tr> <tr> <td>1</td> <td>Ext 2</td> <td>1 = Communication monitoring active when Ext 2 is being used.</td> </tr> <tr> <td>2</td> <td>Local</td> <td>1 = Communication monitoring active when local control is being used.</td> </tr> <tr> <td>3...15</td> <td>Reserved</td> <td></td> </tr> </tbody> </table> |   |   |              | Bit | Name | Value | 0 | Ext 1 | 1 = Communication monitoring active when Ext 1 is being used. | 1 | Ext 2 | 1 = Communication monitoring active when Ext 2 is being used. | 2 | Local | 1 = Communication monitoring active when local control is being used. | 3...15 | Reserved |  |
| Bit   | Name  | Value   |              |     |      |       |   |       |   |   |       |   |   |       |   |        |          |  |
| 0   | Ext 1   | 1 = Communication monitoring active when Ext 1 is being used.   |              |     |      |       |   |       |   |   |       |   |   |       |   |        |          |  |
| 1   | Ext 2   | 1 = Communication monitoring active when Ext 2 is being used.   |              |     |      |       |   |       |   |   |       |   |   |       |   |        |          |  |
| 2   | Local   | 1 = Communication monitoring active when local control is being used.   |              |     |      |       |   |       |   |   |       |   |   |       |   |        |          |  |
| 3...15  | Reserved                                      |   |              |     |      |       |   |       |   |   |       |   |   |       |   |        |          |  |
|   | 0000b...0111b                                 | DDCS controller communication monitoring selection.   | 1 = 1        |     |      |       |   |       |   |   |       |   |   |       |   |        |          |  |
| 60.71   | <i>INU-LSU communication port</i>             | <i>(Only visible when supply unit control activated by 95.20)</i><br>Selects the DDCS channel used for connecting to another converter (such as a supply unit).<br>The selections available, as well as the default, depend on drive hardware.<br>See also section <i>Control of a supply unit (LSU)</i> (page 40).   | see text     |     |      |       |   |       |   |   |       |   |   |       |   |        |          |  |
|   | Not in use                                    | None (communication disabled).  | 0            |     |      |       |   |       |   |   |       |   |   |       |   |        |          |  |
|   | RDCO CH 1                                     | Channel 1 on RDCO module.   | 11           |     |      |       |   |       |   |   |       |   |   |       |   |        |          |  |
|   | DDCS via BC                                   | Connector X201.   | 15           |     |      |       |   |       |   |   |       |   |   |       |   |        |          |  |
| 60.77   | <i>INU-LSU link control</i>                   | <i>(Only visible when supply unit control activated by 95.20)</i><br>Defines the light intensity of the transmission LED of RDCO module channel CH1. (This parameter is effective only when parameter <i>60.71 INU-LSU communication port</i> is set to <i>RDCO CH 1</i> . FDCO modules have a hardware transmitter current selector.)<br>In general, use higher values with longer fiber optic cables. The maximum setting is applicable to the maximum length of the fiber optic link. See <i>Specifications of the fiber optic master/follower link</i> (page 37). | 10           |     |      |       |   |       |   |   |       |   |   |       |   |        |          |  |
|   | 1...15  | Light intensity.  |              |     |      |       |   |       |   |   |       |   |   |       |   |        |          |  |
| 60.78   | <i>INU-LSU comm loss timeout</i>              | <i>(Only visible when supply unit control activated by 95.20)</i><br>Sets a timeout for communication with another converter (such as the supply unit). If a communication break lasts longer than the timeout, the action specified by parameter <i>60.79 INU-LSU comm loss function</i> is taken.   | 100 ms       |     |      |       |   |       |   |   |       |   |   |       |   |        |          |  |
|   | 0...65535 ms                                  | Timeout for communication between converters.   |              |     |      |       |   |       |   |   |       |   |   |       |   |        |          |  |
| 60.79   | <i>INU-LSU comm loss function</i>             | <i>(Only visible when supply unit control activated by 95.20)</i><br>Selects how the inverter unit reacts to a communication break between the inverter unit and the other converter (typically the supply unit).<br> <b>WARNING!</b> With settings other than <i>Fault</i> , the inverter unit will continue operating based on the status information that was last received from the other converter. Make sure this does not cause danger.                                     | <i>Fault</i> |     |      |       |   |       |   |   |       |   |   |       |   |        |          |  |
|   | No action                                     | No action taken.  | 0            |     |      |       |   |       |   |   |       |   |   |       |   |        |          |  |

| No.                                  | Name/Value                  | Description  | Def/FbEq16                    |
|--------------------------------------|-----------------------------|--|-------------------------------|
|                                      | Warning                     | The drive generates a warning ( <i>AF80 INU-LSU comm loss</i> ).   | 1                             |
|                                      | Fault                       | Drive trips on <i>7580 INU-LSU comm loss</i> .   | 2                             |
| <b>61 D2D and DDCS transmit data</b> |                             | Defines the data sent to the DDCS link.<br>See also parameter group <i>60 DDCS communication</i> .   |                               |
| <i>61.01</i>                         | <i>M/F data 1 selection</i> | Preselects the data to be sent as word 1 onto the master/follower link.<br>See also parameter <i>61.25 M/F data 1 value</i> , and section <i>Master/follower functionality</i> (page 31).  | <i>Follower CW</i>            |
|                                      | None                        | None.  | 0                             |
|                                      | CW 16bit                    | Control Word (16 bits)   | 1                             |
|                                      | SW 16bit                    | Status Word (16 bits)  | 4                             |
|                                      | Act1 16bit                  | Actual value ACT1 (16 bits)<br><b>Note:</b> Using this setting to send a reference to the follower is not recommended as the source signal is filtered. Use the "reference" selections instead.  | 5                             |
|                                      | Act2 16bit                  | Actual value ACT2 (16 bits)<br><b>Note:</b> Using this setting to send a reference to the follower is not recommended as the source signal is filtered. Use the "reference" selections instead.  | 6                             |
|                                      | Follower CW                 | A word consisting of bits 0...11 of <i>06.01 Main control word</i> and the bits selected by parameters <i>06.45...06.48</i> .<br><b>Note:</b> Bit 3 of the follower control word is kept on as long as the master is modulating, and when it switches to 0, the follower coasts to a stop. | 27                            |
|                                      | Used speed reference        | <i>24.01 Used speed reference</i> (page 224).  | 6145                          |
|                                      | Torque reference act 5      | <i>26.75 Torque reference act 5</i> (page 246).  | 6731                          |
|                                      | Torque reference used       | <i>26.02 Torque reference used</i> (page 240).   | 6658                          |
|                                      | ACS800 System ctrl SW       | A follower status word compatible with an ACS800 (System Control Program) master. With this setting, status word bit 0 is cleared whenever the run enable signal is missing.   | 28                            |
|                                      | <i>Other</i>                | Source selection (see <i>Terms and abbreviations</i> on page 112).   | -                             |
| <i>61.02</i>                         | <i>M/F data 2 selection</i> | Preselects the data to be sent as word 2 onto the master/follower link.<br>See also parameter <i>61.26 M/F data 2 value</i> .<br>For the selections, see parameter <i>61.01 M/F data 1 selection</i> .   | <i>Used speed reference</i>   |
| <i>61.03</i>                         | <i>M/F data 3 selection</i> | Preselects the data to be sent as word 3 onto the master/follower link.<br>See also parameter <i>61.27 M/F data 3 value</i> .<br>For the selections, see parameter <i>61.01 M/F data 1 selection</i> .   | <i>Torque reference act 5</i> |
| <i>61.25</i>                         | <i>M/F data 1 value</i>     | Displays the data to be sent onto the master/follower link as word 1 as an integer.<br>If no data has been preselected by <i>61.01 M/F data 1 selection</i> , the value to be sent can be written directly into this parameter.  | 0                             |
|                                      | 0...65535                   | Data to be sent as word 1 in master/follower communication.  |                               |

| No.   | Name/Value                          | Description   | Def/FbEq16 |
|-------|-------------------------------------|---|------------|
| 61.26 | <i>M/F data 2 value</i>             | Displays the data to be sent onto the master/follower link as word 2 as an integer.<br>If no data has been preselected by <a href="#">61.02 M/F data 2 selection</a> , the value to be sent can be written directly into this parameter.  | 0          |
|       | 0...65535                           | Data to be sent as word 2 in master/follower communication.   |            |
| 61.27 | <i>M/F data 3 value</i>             | Displays the data to be sent onto the master/follower link as word 3 as an integer.<br>If no data has been preselected by <a href="#">61.03 M/F data 3 selection</a> , the value to be sent can be written directly into this parameter.  | 0          |
|       | 0...65535                           | Data to be sent as word 3 in master/follower communication.   |            |
| 61.45 | <i>Data set 2 data 1 selection</i>  | Parameters <a href="#">61.45</a> ... <a href="#">61.50</a> preselect data to be sent in data sets 2 and 4 to the external controller. These data sets are used in ModuleBus communication with a "standard drive" ( <a href="#">60.50 DDCS controller drive type = ABB standard drive</a> ). Parameters <a href="#">61.95</a> ... <a href="#">61.100</a> display the data to be sent to the external controller. If no data has been preselected, the value to be sent can be written directly into these parameters.<br>For example, this parameter preselects the data for word 1 of data set 2. Parameter <a href="#">61.95 Data set 2 data 1 value</a> displays the selected data in integer format. If no data is preselected, the value to be sent can be written directly into parameter <a href="#">61.95</a> . | None       |
|       | None                                | None.   | 0          |
|       | CW 16bit                            | Control Word (16 bits)  | 1          |
|       | SW 16bit                            | Status Word (16 bits)   | 4          |
|       | Act1 16bit                          | Actual value ACT1 (16 bits)   | 5          |
|       | Act2 16bit                          | Actual value ACT2 (16 bits)   | 6          |
|       | <i>Other</i>                        | Source selection (see <a href="#">Terms and abbreviations</a> on page 112).   | -          |
| 61.46 | <i>Data set 2 data 2 selection</i>  | Preselects the data to be sent as word 2 of data set 2 to the external controller.<br>See also parameter <a href="#">61.96 Data set 2 data 2 value</a> .<br>For the selections, see parameter <a href="#">61.45 Data set 2 data 1 selection</a> .   | None       |
| 61.47 | <i>Data set 2 data 3 selection</i>  | See parameter <a href="#">61.45 Data set 2 data 1 selection</a> .   | None       |
| ...   | ...                                 | ...   | ...        |
| 61.50 | <i>Data set 4 data 3 selection</i>  | See parameter <a href="#">61.45 Data set 2 data 1 selection</a> .   | None       |
| 61.51 | <i>Data set 11 data 1 selection</i> | Parameters <a href="#">61.51</a> ... <a href="#">61.74</a> preselect data to be sent in data sets 11, 13, 15, 17, 19, 21, 23 and 25 to the external controller.<br>Parameters <a href="#">61.101</a> ... <a href="#">61.124</a> display the data to be sent to the external controller. If no data has been preselected, the value to be sent can be written directly into these parameters.<br>For example, this parameter preselects the data for word 1 of data set 11. Parameter <a href="#">61.101 Data set 11 data 1 value</a> displays the selected data in integer format. If no data is preselected, the value to be sent can be written directly into parameter <a href="#">61.101</a> .  | None       |
|       | None                                | None.   | 0          |



| No.    | Name/Value                          | Description   | Def/FbEq16  |
|--------|-------------------------------------|---|-------------|
|        | CW 16bit                            | Control Word (16 bits)  | 1           |
|        | SW 16bit                            | Status Word (16 bits)   | 4           |
|        | Act1 16bit                          | Actual value ACT1 (16 bits)   | 5           |
|        | Act2 16bit                          | Actual value ACT2 (16 bits)   | 6           |
|        | <i>Other</i>                        | Source selection (see <i>Terms and abbreviations</i> on page 112).  | -           |
| 61.52  | <i>Data set 11 data 2 selection</i> | Preselects the data to be sent as word 2 of data set 11 to the external controller.<br>See also parameter <i>61.102 Data set 11 data 2 value</i> .<br>For the selections, see parameter <i>61.51 Data set 11 data 1 selection</i> .                     | <i>None</i> |
| 61.53  | <i>Data set 11 data 3 selection</i> | Preselects the data to be sent as word 3 of data set 11 to the external controller.<br>See also parameter <i>61.103 Data set 11 data 3 value</i> .<br>For the selections, see parameter <i>61.51 Data set 11 data 1 selection</i> .                     | <i>None</i> |
| 61.54  | <i>Data set 13 data 1 selection</i> | See parameter <i>61.51 Data set 11 data 1 selection</i> .   | <i>None</i> |
| ...    | ...                                 | ...   | ...         |
| 61.74  | <i>Data set 25 data 3 selection</i> | See parameter <i>61.51 Data set 11 data 1 selection</i> .   | <i>None</i> |
| 61.95  | <i>Data set 2 data 1 value</i>      | Displays (in integer format) the data to be sent to the external controller as word 1 of data set 2.<br>If no data has been preselected by <i>61.45 Data set 2 data 1 selection</i> , the value to be sent can be written directly into this parameter. | 0           |
|        | 0...65535                           | Data to be sent as word 1 of data set 2.  |             |
| 61.96  | <i>Data set 2 data 2 value</i>      | Displays (in integer format) the data to be sent to the external controller as word 2 of data set 2.<br>If no data has been preselected by <i>61.46 Data set 2 data 2 selection</i> , the value to be sent can be written directly into this parameter. | 0           |
|        | 0...65535                           | Data to be sent as word 2 of data set 2.  |             |
| 61.97  | <i>Data set 2 data 3 value</i>      | Displays (in integer format) the data to be sent to the external controller as word 3 of data set 2.<br>If no data has been preselected by <i>61.47 Data set 2 data 3 selection</i> , the value to be sent can be written directly into this parameter. | 0           |
|        | 0...65535                           | Data to be sent as word 3 of data set 2.  |             |
| ...    | ...                                 | ...   | ...         |
| 61.100 | <i>Data set 4 data 3 value</i>      | Displays (in integer format) the data to be sent to the external controller as word 3 of data set 4.<br>If no data has been selected by <i>61.50 Data set 4 data 3 selection</i> , the value to be sent can be written directly into this parameter.    | 0           |
|        | 0...65535                           | Data to be sent as word 3 of data set 4.  |             |



| No.    | Name/Value                                     | Description   | Def/FbEq16 |
|--------|--|---|------------|
| 61.101 | <a href="#">Data set 11 data 1 value</a>       | Displays (in integer format) the data to be sent to the external controller as word 1 of data set 11.<br>If no data has been preselected by <a href="#">61.51 Data set 11 data 1 selection</a> , the value to be sent can be written directly into this parameter.  | 0          |
|        | 0...65535                                      | Data to be sent as word 1 of data set 11.   |            |
| 61.102 | <a href="#">Data set 11 data 2 value</a>       | Displays (in integer format) the data to be sent to the external controller as word 2 of data set 11.<br>If no data has been preselected by <a href="#">61.52 Data set 11 data 2 selection</a> , the value to be sent can be written directly into this parameter.  | 0          |
|        | 0...65535                                      | Data to be sent as word 2 of data set 11.   |            |
| 61.103 | <a href="#">Data set 11 data 3 value</a>       | Displays (in integer format) the data to be sent to the external controller as word 3 of data set 11.<br>If no data has been selected by <a href="#">61.53 Data set 11 data 3 selection</a> , the value to be sent can be written directly into this parameter.   | 0          |
|        | 0...65535                                      | Data to be sent as word 3 of data set 11.   |            |
| 61.104 | <a href="#">Data set 13 data 1 value</a>       | Displays (in integer format) the data to be sent to the external controller as word 1 of data set 13.<br>If no data has been selected by <a href="#">61.54 Data set 13 data 1 selection</a> , the value to be sent can be written directly into this parameter.   | 0          |
|        | 0...65535                                      | Data to be sent as word 1 of data set 13.   |            |
| ...    | ...  | ...   | ...        |
| 61.124 | <a href="#">Data set 25 data 3 value</a>       | Displays (in integer format) the data to be sent to the external controller as word 3 of data set 25.<br>If no data has been selected by <a href="#">61.74 Data set 25 data 3 selection</a> , the value to be sent can be written directly into this parameter.   | 0          |
|        | 0...65535                                      | Data to be sent as word 3 of data set 25.   |            |
| 61.151 | <a href="#">INU-LSU data set 10 data 1 sel</a> | <i>(Parameters 61.151...61.203 only visible when supply unit control activated by 95.20)</i><br>Parameters <a href="#">61.151...61.153</a> preselect data to be sent in data set 10 to another converter (typically the supply unit of the drive).<br>Parameters <a href="#">61.201...61.203</a> display the data to be sent to the other converter. If no data has been preselected, the value to be sent can be written directly into these parameters.<br>For example, this parameter preselects the data for word 1 of data set 10. Parameter <a href="#">61.201 INU-LSU data set 10 data 1 value</a> displays the selected data in integer format. If no data is preselected, the value to be sent can be written directly into parameter <a href="#">61.201</a> . | LSU CW     |
|        | None   | None.   | 0          |
|        | LSU CW   | Control word for the supply unit.   | 22         |
|        | DC voltage reference                           | <a href="#">94.20 DC voltage reference</a> (page 399).  | 24084      |
|        | Reactive power reference                       | <a href="#">94.30 Reactive power reference</a> (page 399).  | 24094      |
|        | <a href="#">Other</a>                          | Source selection (see <a href="#">Terms and abbreviations</a> on page 112).   | -          |

## 370 Parameters

| No.                                 | Name/Value                                       | Description  | Def/FbEq16                               |
|-------------------------------------|--|--|--|
| 61.152                              | <a href="#">INU-LSU data set 10 data 2 sel</a>   | Preselects the data to be sent as word 2 of data set 10 to the other converter.<br>See also parameter <a href="#">61.202 INU-LSU data set 10 data 2 value</a> .<br>For the selections, see parameter <a href="#">61.151 INU-LSU data set 10 data 1 sel</a> .       | <a href="#">DC voltage reference</a>     |
| 61.153                              | <a href="#">INU-LSU data set 10 data 3 sel</a>   | Preselects the data to be sent as word 3 of data set 10 to the other converter.<br>See also parameter <a href="#">61.203 INU-LSU data set 10 data 3 value</a> .<br>For the selections, see parameter <a href="#">61.151 INU-LSU data set 10 data 1 sel</a> .       | <a href="#">Reactive power reference</a> |
| 61.201                              | <a href="#">INU-LSU data set 10 data 1 value</a> | Displays (in integer format) the data to be sent to the other converter as word 1 of data set 10.<br>If no data has been preselected by <a href="#">61.151 INU-LSU data set 10 data 1 sel</a> , the value to be sent can be written directly into this parameter.  | 0  |
|                                     | 0...65535  | Data to be sent as word 1 of data set 10.  |  |
| 61.202                              | <a href="#">INU-LSU data set 10 data 2 value</a> | Displays (in integer format) the data to be sent to the other converter as word 2 of data set 10.<br>If no data has been preselected by <a href="#">61.152 INU-LSU data set 10 data 2 sel</a> , the value to be sent can be written directly into this parameter.  | 0  |
|                                     | 0...65535  | Data to be sent as word 2 of data set 10.  |  |
| 61.203                              | <a href="#">INU-LSU data set 10 data 3 value</a> | Displays (in integer format) the data to be sent to the other converter as word 3 of data set 10.<br>If no data has been selected by <a href="#">61.153 INU-LSU data set 10 data 3 sel</a> , the value to be sent can be written directly into this parameter.     | 0  |
|                                     | 0...65535  | Data to be sent as word 3 of data set 10.  |  |
| <b>62 D2D and DDCS receive data</b> |  | Mapping of data received through the DDCS link.<br>See also parameter group <a href="#">60 DDCS communication</a> .  |  |
| 62.01                               | <a href="#">M/F data 1 selection</a>             | (Follower only) Defines a target for the data received as word 1 from the master through the master/follower link.<br>See also parameter <a href="#">62.25 MF data 1 value</a> .   | <a href="#">None</a>                     |
|                                     | None   | None.  | 0  |
|                                     | CW 16bit   | Control Word (16 bits)   | 1  |
|                                     | Ref1 16bit                                       | Reference REF1 (16 bits)   | 2  |
|                                     | Ref2 16bit                                       | Reference REF2 (16 bits)   | 3  |
|                                     | <a href="#">Other</a>                            | Source selection (see <a href="#">Terms and abbreviations</a> on page 112).  | -  |
| 62.02                               | <a href="#">M/F data 2 selection</a>             | (Follower only) Defines a target for the data received as word 2 from the master through the master/follower link.<br>See also parameter <a href="#">62.26 MF data 2 value</a> .<br>For the selections, see parameter <a href="#">62.01 M/F data 1 selection</a> . | <a href="#">None</a>                     |
| 62.03                               | <a href="#">M/F data 3 selection</a>             | (Follower only) Defines a target for the data received as word 3 from the master through the master/follower link.<br>See also parameter <a href="#">62.27 MF data 3 value</a> .<br>For the selections, see parameter <a href="#">62.01 M/F data 1 selection</a> . | <a href="#">None</a>                     |
| 62.04                               | <a href="#">Follower node 2 data 1 sel</a>       | Defines a target for the data received as word 1 from the first follower (ie. the follower with node address 2) through the master/follower link.<br>See also parameter <a href="#">62.28 Follower node 2 data 1 value</a> .                                       | <a href="#">Follower SW</a>              |

| No.   | Name/Value                                 | Description   | Def/FbEq16  |
|-------|--|---|-------------|
|       | None                                       | None.   | 0           |
|       | Follower SW                                | Status word of the follower. See also parameter <a href="#">60.18 Follower enable</a> .   | 26          |
|       | <i>Other</i>                               | Source selection (see <a href="#">Terms and abbreviations</a> on page 112).   | -           |
| 62.05 | <a href="#">Follower node 2 data 2 sel</a> | Defines a target for the data received as word 2 from the first follower (ie. the follower with node address 2) through the master/follower link.<br>See also parameter <a href="#">62.29 Follower node 2 data 2 value</a> .<br>For the selections, see parameter <a href="#">62.04 Follower node 2 data 1 sel</a> .  | None        |
| 62.06 | <a href="#">Follower node 2 data 3 sel</a> | Defines a target for the data received as word 3 from the first follower (ie. the follower with node address 2) through the master/follower link.<br>See also parameter <a href="#">62.30 Follower node 2 data 3 value</a> .<br>For the selections, see parameter <a href="#">62.04 Follower node 2 data 1 sel</a> .  | None        |
| 62.07 | <a href="#">Follower node 3 data 1 sel</a> | Defines a target for the data received as word 1 from the second follower (ie. the follower with node address 3) through the master/follower link.<br>See also parameter <a href="#">62.31 Follower node 3 data 1 value</a> .<br>For the selections, see parameter <a href="#">62.04 Follower node 2 data 1 sel</a> . | Follower SW |
| 62.08 | <a href="#">Follower node 3 data 2 sel</a> | Defines a target for the data received as word 2 from the second follower (ie. the follower with node address 3) through the master/follower link.<br>See also parameter <a href="#">62.32 Follower node 3 data 2 value</a> .<br>For the selections, see parameter <a href="#">62.04 Follower node 2 data 1 sel</a> . | None        |
| 62.09 | <a href="#">Follower node 3 data 3 sel</a> | Defines a target for the data received as word 3 from the second follower (ie. the follower with node address 3) through the master/follower link.<br>See also parameter <a href="#">62.33 Follower node 3 data 3 value</a> .<br>For the selections, see parameter <a href="#">62.04 Follower node 2 data 1 sel</a> . | None        |
| 62.10 | <a href="#">Follower node 4 data 1 sel</a> | Defines a target for the data received as word 1 from the third follower (ie. the follower with node address 4) through the master/follower link.<br>See also parameter <a href="#">62.34 Follower node 4 data 1 value</a> .<br>For the selections, see parameter <a href="#">62.04 Follower node 2 data 1 sel</a> .  | Follower SW |
| 62.11 | <a href="#">Follower node 4 data 2 sel</a> | Defines a target for the data received as word 2 from the third follower (ie. the follower with node address 4) through the master/follower link.<br>See also parameter <a href="#">62.35 Follower node 4 data 2 value</a> .<br>For the selections, see parameter <a href="#">62.04 Follower node 2 data 1 sel</a> .  | None        |
| 62.12 | <a href="#">Follower node 4 data 3 sel</a> | Defines a target for the data received as word 3 from the third follower (ie. the follower with node address 4) through the master/follower link.<br>See also parameter <a href="#">62.36 Follower node 4 data 3 value</a> .<br>For the selections, see parameter <a href="#">62.04 Follower node 2 data 1 sel</a> .  | None        |

## 372 Parameters

| No.   | Name/Value                          | Description   | Def/FbEq16 |
|-------|-------------------------------------|---|------------|
| 62.25 | <i>MF data 1 value</i>              | (Follower only) Displays, in integer format, the data received from the master as word 1.<br>Parameter <a href="#">62.01 M/F data 1 selection</a> can be used to select a target for the received data. This parameter can also be used as a signal source by other parameters.                                   | 0          |
|       | 0...65535                           | Data received as word 1 in master/follower communication.   |            |
| 62.26 | <i>MF data 2 value</i>              | (Follower only) Displays, in integer format, the data received from the master as word 2.<br>Parameter <a href="#">62.02 M/F data 2 selection</a> can be used to select a target for the received data. This parameter can also be used as a signal source by other parameters.                                   | 0          |
|       | 0...65535                           | Data received as word 2 in master/follower communication.   |            |
| 62.27 | <i>MF data 3 value</i>              | (Follower only) Displays, in integer format, the data received from the master as word 3.<br>Parameter <a href="#">62.03 M/F data 3 selection</a> can be used to select a target for the received data. This parameter can also be used as a signal source by other parameters.                                   | 0          |
|       | 0...65535                           | Data received as word 3 in master/follower communication.   |            |
| 62.28 | <i>Follower node 2 data 1 value</i> | Displays, in integer format, the data received from the first follower (ie. follower with node address 2) as word 1.<br>Parameter <a href="#">62.04 Follower node 2 data 1 sel</a> can be used to select a target for the received data. This parameter can also be used as a signal source by other parameters.  | 0          |
|       | 0...65535                           | Data received as word 1 from follower with node address 2.  |            |
| 62.29 | <i>Follower node 2 data 2 value</i> | Displays, in integer format, the data received from the first follower (ie. follower with node address 2) as word 2.<br>Parameter <a href="#">62.05 Follower node 2 data 2 sel</a> can be used to select a target for the received data. This parameter can also be used as a signal source by other parameters.  | 0          |
|       | 0...65535                           | Data received as word 2 from follower with node address 2.  |            |
| 62.30 | <i>Follower node 2 data 3 value</i> | Displays, in integer format, the data received from the first follower (ie. follower with node address 2) as word 3.<br>Parameter <a href="#">62.06 Follower node 2 data 3 sel</a> can be used to select a target for the received data. This parameter can also be used as a signal source by other parameters.  | 0          |
|       | 0...65535                           | Data received as word 3 from follower with node address 2.  |            |
| 62.31 | <i>Follower node 3 data 1 value</i> | Displays, in integer format, the data received from the second follower (ie. follower with node address 3) as word 1.<br>Parameter <a href="#">62.07 Follower node 3 data 1 sel</a> can be used to select a target for the received data. This parameter can also be used as a signal source by other parameters. | 0          |
|       | 0...65535                           | Data received as word 1 from follower with node address 3.  |            |
| 62.32 | <i>Follower node 3 data 2 value</i> | Displays, in integer format, the data received from the second follower (ie. follower with node address 3) as word 2.<br>Parameter <a href="#">62.08 Follower node 3 data 2 sel</a> can be used to select a target for the received data. This parameter can also be used as a signal source by other parameters. | 0          |
|       | 0...65535                           | Data received as word 2 from follower with node address 3.  |            |

| No.   | Name/Value                          | Description  | Def/FbEq16 |      |             |   |             |  |   |             |  |     |     |     |    |             |  |  |
|-------|-------------------------------------|--|------------|------|-------------|---|-------------|--|---|-------------|--|-----|-----|-----|----|-------------|--|--|
| 62.33 | <i>Follower node 3 data 3 value</i> | Displays, in integer format, the data received from the second follower (ie. follower with node address 3) as word 3.<br>Parameter <a href="#">62.09 Follower node 3 data 3 sel</a> can be used to select a target for the received data. This parameter can also be used as a signal source by other parameters.  | 0          |      |             |   |             |  |   |             |  |     |     |     |    |             |  |  |
|       | 0...65535                           | Data received as word 3 from follower with node address 3.   |            |      |             |   |             |  |   |             |  |     |     |     |    |             |  |  |
| 62.34 | <i>Follower node 4 data 1 value</i> | Displays, in integer format, the data received from the third follower (ie. follower with node address 4) as word 1.<br>Parameter <a href="#">62.10 Follower node 4 data 1 sel</a> can be used to select a target for the received data. This parameter can also be used as a signal source by other parameters.   | 0          |      |             |   |             |  |   |             |  |     |     |     |    |             |  |  |
|       | 0...65535                           | Data received as word 1 from follower with node address 4.   |            |      |             |   |             |  |   |             |  |     |     |     |    |             |  |  |
| 62.35 | <i>Follower node 4 data 2 value</i> | Displays, in integer format, the data received from the third follower (ie. follower with node address 4) as word 2.<br>Parameter <a href="#">62.11 Follower node 4 data 2 sel</a> can be used to select a target for the received data. This parameter can also be used as a signal source by other parameters.   | 0          |      |             |   |             |  |   |             |  |     |     |     |    |             |  |  |
|       | 0...65535                           | Data received as word 2 from follower with node address 4.   |            |      |             |   |             |  |   |             |  |     |     |     |    |             |  |  |
| 62.36 | <i>Follower node 4 data 3 value</i> | Displays, in integer format, the data received from the third follower (ie. follower with node address 4) as word 3.<br>Parameter <a href="#">62.12 Follower node 4 data 3 sel</a> can be used to select a target for the received data. This parameter can also be used as a signal source by other parameters.   | 0          |      |             |   |             |  |   |             |  |     |     |     |    |             |  |  |
|       | 0...65535                           | Data received as word 3 from follower with node address 4.   |            |      |             |   |             |  |   |             |  |     |     |     |    |             |  |  |
| 62.37 | <i>M/F communication status 1</i>   | In the master, displays the status of the communication with followers specified by parameter <a href="#">60.19 M/F comm supervision sel 1</a> .<br>In a follower, bit 0 indicates the status of the communication with the master.  | -          |      |             |   |             |  |   |             |  |     |     |     |    |             |  |  |
|       |                                     | <table border="1"> <thead> <tr> <th>Bit</th> <th>Name</th> <th>Description</th> </tr> </thead> <tbody> <tr> <td>0</td> <td>Follower 1</td> <td>1 (in the master) = Communication with follower 1 OK.<br/>1 (in a follower) = Communication with master OK.</td> </tr> <tr> <td>1</td> <td>Follower 2</td> <td>1 = Communication with follower 2 OK.</td> </tr> <tr> <td>...</td> <td>...</td> <td>...</td> </tr> <tr> <td>15</td> <td>Follower 16</td> <td>1 = Communication with follower 16 OK.</td> </tr> </tbody> </table> | Bit        | Name | Description | 0 | Follower 1  | 1 (in the master) = Communication with follower 1 OK.<br>1 (in a follower) = Communication with master OK. | 1 | Follower 2  | 1 = Communication with follower 2 OK.  | ... | ... | ... | 15 | Follower 16 | 1 = Communication with follower 16 OK. |  |
| Bit   | Name                                | Description  |            |      |             |   |             |  |   |             |  |     |     |     |    |             |  |  |
| 0     | Follower 1                          | 1 (in the master) = Communication with follower 1 OK.<br>1 (in a follower) = Communication with master OK.   |            |      |             |   |             |  |   |             |  |     |     |     |    |             |  |  |
| 1     | Follower 2                          | 1 = Communication with follower 2 OK.  |            |      |             |   |             |  |   |             |  |     |     |     |    |             |  |  |
| ...   | ...                                 | ...  |            |      |             |   |             |  |   |             |  |     |     |     |    |             |  |  |
| 15    | Follower 16                         | 1 = Communication with follower 16 OK.   |            |      |             |   |             |  |   |             |  |     |     |     |    |             |  |  |
|       | 0000h...FFFFh                       | M/F communication status (followers 1...16).   | 1 = 1      |      |             |   |             |  |   |             |  |     |     |     |    |             |  |  |
| 62.38 | <i>M/F communication status 2</i>   | In the master, displays the status of the communication with followers specified by parameter <a href="#">60.20 M/F comm supervision sel 2</a> .   | -          |      |             |   |             |  |   |             |  |     |     |     |    |             |  |  |
|       |                                     | <table border="1"> <thead> <tr> <th>Bit</th> <th>Name</th> <th>Description</th> </tr> </thead> <tbody> <tr> <td>0</td> <td>Follower 17</td> <td>1 = Communication with follower 17 OK.</td> </tr> <tr> <td>1</td> <td>Follower 18</td> <td>1 = Communication with follower 18 OK.</td> </tr> <tr> <td>...</td> <td>...</td> <td>...</td> </tr> <tr> <td>15</td> <td>Follower 32</td> <td>1 = Communication with follower 32 OK.</td> </tr> </tbody> </table>   | Bit        | Name | Description | 0 | Follower 17 | 1 = Communication with follower 17 OK.   | 1 | Follower 18 | 1 = Communication with follower 18 OK. | ... | ... | ... | 15 | Follower 32 | 1 = Communication with follower 32 OK. |  |
| Bit   | Name                                | Description  |            |      |             |   |             |  |   |             |  |     |     |     |    |             |  |  |
| 0     | Follower 17                         | 1 = Communication with follower 17 OK.   |            |      |             |   |             |  |   |             |  |     |     |     |    |             |  |  |
| 1     | Follower 18                         | 1 = Communication with follower 18 OK.   |            |      |             |   |             |  |   |             |  |     |     |     |    |             |  |  |
| ...   | ...                                 | ...  |            |      |             |   |             |  |   |             |  |     |     |     |    |             |  |  |
| 15    | Follower 32                         | 1 = Communication with follower 32 OK.   |            |      |             |   |             |  |   |             |  |     |     |     |    |             |  |  |
|       | 0000h...FFFFh                       | M/F communication status (followers 17...32).  | 1 = 1      |      |             |   |             |  |   |             |  |     |     |     |    |             |  |  |

## 374 Parameters

| No.  | Name/Value                         | Description   | Def/FbEq16  |     |      |             |   |             |                        |   |             |                        |     |     |     |    |             |                        |
|--|------------------------------------|---|-------------|-----|------|-------------|---|-------------|------------------------|---|-------------|------------------------|-----|-----|-----|----|-------------|------------------------|
| 62.41  | <i>M/F follower ready status 1</i> | In the master, displays the ready status of the communication with followers specified by parameter <a href="#">60.23 M/F status supervision sel 1</a> .  | -           |     |      |             |   |             |                        |   |             |                        |     |     |     |    |             |                        |
| <table border="1"> <thead> <tr> <th>Bit</th> <th>Name</th> <th>Description</th> </tr> </thead> <tbody> <tr> <td>0</td> <td>Follower 1</td> <td>1 = Follower 1 ready.</td> </tr> <tr> <td>1</td> <td>Follower 2</td> <td>1 = Follower 2 ready.</td> </tr> <tr> <td>...</td> <td>...</td> <td>...</td> </tr> <tr> <td>15</td> <td>Follower 16</td> <td>1 = Follower 16 ready.</td> </tr> </tbody> </table>     |                                    |   |             | Bit | Name | Description | 0 | Follower 1  | 1 = Follower 1 ready.  | 1 | Follower 2  | 1 = Follower 2 ready.  | ... | ... | ... | 15 | Follower 16 | 1 = Follower 16 ready. |
| Bit  | Name                               | Description   |             |     |      |             |   |             |                        |   |             |                        |     |     |     |    |             |                        |
| 0  | Follower 1                         | 1 = Follower 1 ready.   |             |     |      |             |   |             |                        |   |             |                        |     |     |     |    |             |                        |
| 1  | Follower 2                         | 1 = Follower 2 ready.   |             |     |      |             |   |             |                        |   |             |                        |     |     |     |    |             |                        |
| ...  | ...                                | ...   |             |     |      |             |   |             |                        |   |             |                        |     |     |     |    |             |                        |
| 15   | Follower 16                        | 1 = Follower 16 ready.  |             |     |      |             |   |             |                        |   |             |                        |     |     |     |    |             |                        |
| 0000h...FFFFh  |                                    | Follower 1...16 ready status.   | 1 = 1       |     |      |             |   |             |                        |   |             |                        |     |     |     |    |             |                        |
| 62.42  | <i>M/F follower ready status 2</i> | In the master, displays the ready status of the communication with followers specified by parameter <a href="#">60.24 M/F status supervision sel 2</a> .  | -           |     |      |             |   |             |                        |   |             |                        |     |     |     |    |             |                        |
| <table border="1"> <thead> <tr> <th>Bit</th> <th>Name</th> <th>Description</th> </tr> </thead> <tbody> <tr> <td>0</td> <td>Follower 17</td> <td>1 = Follower 17 ready.</td> </tr> <tr> <td>1</td> <td>Follower 18</td> <td>1 = Follower 18 ready.</td> </tr> <tr> <td>...</td> <td>...</td> <td>...</td> </tr> <tr> <td>15</td> <td>Follower 32</td> <td>1 = Follower 32 ready.</td> </tr> </tbody> </table> |                                    |   |             | Bit | Name | Description | 0 | Follower 17 | 1 = Follower 17 ready. | 1 | Follower 18 | 1 = Follower 18 ready. | ... | ... | ... | 15 | Follower 32 | 1 = Follower 32 ready. |
| Bit  | Name                               | Description   |             |     |      |             |   |             |                        |   |             |                        |     |     |     |    |             |                        |
| 0  | Follower 17                        | 1 = Follower 17 ready.  |             |     |      |             |   |             |                        |   |             |                        |     |     |     |    |             |                        |
| 1  | Follower 18                        | 1 = Follower 18 ready.  |             |     |      |             |   |             |                        |   |             |                        |     |     |     |    |             |                        |
| ...  | ...                                | ...   |             |     |      |             |   |             |                        |   |             |                        |     |     |     |    |             |                        |
| 15   | Follower 32                        | 1 = Follower 32 ready.  |             |     |      |             |   |             |                        |   |             |                        |     |     |     |    |             |                        |
| 0000h...FFFFh  |                                    | Follower 17...32 ready status.  | 1 = 1       |     |      |             |   |             |                        |   |             |                        |     |     |     |    |             |                        |
| 62.45  | <i>Data set 1 data 1 selection</i> | Parameters <a href="#">62.45</a> ... <a href="#">62.50</a> define a target for the data received in data sets 1 and 3 from the external controller. These data sets are used in ModuleBus communication with a "standard drive" ( <a href="#">60.50 DDCS controller drive type = ABB standard drive</a> ).<br>Parameters <a href="#">62.95</a> ... <a href="#">62.100</a> display the data received from the external controller in integer format, and can be used as sources by other parameters.<br>For example, this parameter selects a target for word 1 of data set 1. Parameter <a href="#">62.95 Data set 1 data 1 value</a> displays the received data in integer format, and can also be used as a source by other parameters. | <i>None</i> |     |      |             |   |             |                        |   |             |                        |     |     |     |    |             |                        |
| None   |                                    | None.   | 0           |     |      |             |   |             |                        |   |             |                        |     |     |     |    |             |                        |
| CW 16bit   |                                    | Control Word (16 bits)  | 1           |     |      |             |   |             |                        |   |             |                        |     |     |     |    |             |                        |
| Ref1 16bit   |                                    | Reference REF1 (16 bits)  | 2           |     |      |             |   |             |                        |   |             |                        |     |     |     |    |             |                        |
| Ref2 16bit   |                                    | Reference REF2 (16 bits)  | 3           |     |      |             |   |             |                        |   |             |                        |     |     |     |    |             |                        |
| <i>Other</i>   |                                    | Source selection (see <a href="#">Terms and abbreviations</a> on page 112).   | -           |     |      |             |   |             |                        |   |             |                        |     |     |     |    |             |                        |
| 62.46  | <i>Data set 1 data 2 selection</i> | Defines a target for the data received as word 2 of data set 1. See also parameter <a href="#">62.96 Data set 1 data 2 value</a> .<br>For the selections, see parameter <a href="#">62.45 Data set 1 data 1 selection</a> .   | <i>None</i> |     |      |             |   |             |                        |   |             |                        |     |     |     |    |             |                        |
| 62.47  | <i>Data set 1 data 3 selection</i> | See parameter <a href="#">62.45 Data set 1 data 1 selection</a> .   | <i>None</i> |     |      |             |   |             |                        |   |             |                        |     |     |     |    |             |                        |
| ...  | ...                                | ...   | ...         |     |      |             |   |             |                        |   |             |                        |     |     |     |    |             |                        |
| 62.50  | <i>Data set 3 data 3 selection</i> | See parameter <a href="#">62.45 Data set 1 data 1 selection</a> .   | <i>None</i> |     |      |             |   |             |                        |   |             |                        |     |     |     |    |             |                        |

| No.   | Name/Value                                   | Description  | Def/FbEq16 |
|-------|--|--|------------|
| 62.51 | <a href="#">Data set 10 data 1 selection</a> | Parameters <a href="#">62.51</a> ... <a href="#">62.74</a> define a target for the data received in data sets 10, 12, 14, 16, 18, 20, 22 and 24 from the external controller.<br>Parameters <a href="#">62.101</a> ... <a href="#">62.124</a> display the data received from the external controller in integer format, and can be used as sources by other parameters.<br>For example, this parameter selects a target for word 1 of data set 10. Parameter <a href="#">62.101 Data set 10 data 1 value</a> displays the received data in integer format, and can also be used as a source by other parameters. | None       |
|       | None   | None.  | 0          |
|       | CW 16bit                                     | Control Word (16 bits)   | 1          |
|       | Ref1 16bit                                   | Reference REF1 (16 bits)   | 2          |
|       | Ref2 16bit                                   | Reference REF2 (16 bits)   | 3          |
|       | <i>Other</i>                                 | Source selection (see <a href="#">Terms and abbreviations</a> on page 112).  | -          |
| 62.52 | <a href="#">Data set 10 data 2 selection</a> | Defines a target for the data received as word 2 of data set 10. See also parameter <a href="#">62.102 Data set 10 data 2 value</a> .<br>For the selections, see parameter <a href="#">62.51 Data set 10 data 1 selection</a> .  | None       |
| 62.53 | <a href="#">Data set 10 data 3 selection</a> | Defines a target for the data received as word 3 of data set 10. See also parameter <a href="#">62.103 Data set 10 data 3 value</a> .<br>For the selections, see parameter <a href="#">62.51 Data set 10 data 1 selection</a> .  | None       |
| 62.54 | <a href="#">Data set 12 data 1 selection</a> | See parameter <a href="#">62.51 Data set 10 data 1 selection</a> .   | None       |
| ...   | ...  | ...  | ...        |
| 62.74 | <a href="#">Data set 24 data 3 selection</a> | See parameter <a href="#">62.51 Data set 10 data 1 selection</a> .   | None       |
| 62.95 | <a href="#">Data set 1 data 1 value</a>      | Displays (in integer format) the data received from the external controller as word 1 of data set 1.<br>A target for this data can be selected by parameter <a href="#">62.45 Data set 1 data 1 selection</a> . The value can also be used as a source by another parameter.   | 0          |
|       | 0...65535                                    | Data received as word 1 of data set 1.   |            |
| 62.96 | <a href="#">Data set 1 data 2 value</a>      | Displays (in integer format) the data received from the external controller as word 2 of data set 1.<br>A target for this data can be selected by parameter <a href="#">62.46 Data set 1 data 2 selection</a> . The value can also be used as a source by another parameter.   | 0          |
|       | 0...65535                                    | Data received as word 2 of data set 1.   |            |



## 376 Parameters

| No.    | Name/Value                               | Description  | Def/FbEq16 |
|--------|--|--|------------|
| 62.97  | <a href="#">Data set 1 data 3 value</a>  | Displays (in integer format) the data received from the external controller as word 3 of data set 1.<br>A target for this data can be selected by parameter <a href="#">62.47 Data set 1 data 3 selection</a> . The value can also be used as a source by another parameter.   | 0          |
|        | 0...65535                                | Data received as word 3 of data set 1.   |            |
| ...    | ...                                      | ...  | ...        |
| 62.100 | <a href="#">Data set 3 data 3 value</a>  | Displays (in integer format) the data received from the external controller as word 3 of data set 3.<br>A target for this data can be selected by parameter <a href="#">62.50 Data set 3 data 3 selection</a> . The value can also be used as a source by another parameter.   | 0          |
|        | 0...65535                                | Data received as word 3 of data set 3.   |            |
| 62.101 | <a href="#">Data set 10 data 1 value</a> | Displays (in integer format) the data received from the external controller as word 1 of data set 10.<br>A target for this data can be selected by parameter <a href="#">62.51 Data set 10 data 1 selection</a> . The value can also be used as a source by another parameter. | 0          |
|        | 0...65535                                | Data received as word 1 of data set 10.  |            |
| 62.102 | <a href="#">Data set 10 data 2 value</a> | Displays (in integer format) the data received from the external controller as word 2 of data set 10.<br>A target for this data can be selected by parameter <a href="#">62.52 Data set 10 data 2 selection</a> . The value can also be used as a source by another parameter. | 0          |
|        | 0...65535                                | Data received as word 2 of data set 10.  |            |
| 62.103 | <a href="#">Data set 10 data 3 value</a> | Displays (in integer format) the data received from the external controller as word 3 of data set 10.<br>A target for this data can be selected by parameter <a href="#">62.53 Data set 10 data 3 selection</a> . The value can also be used as a source by another parameter. | 0          |
|        | 0...65535                                | Data received as word 3 of data set 10.  |            |
| 62.104 | <a href="#">Data set 12 data 1 value</a> | Displays (in integer format) the data received from the external controller as word 1 of data set 12.<br>A target for this data can be selected by parameter <a href="#">62.54 Data set 12 data 1 selection</a> . The value can also be used as a source by another parameter. | 0          |
|        | 0...65535                                | Data received as word 1 of data set 12.  |            |
| ...    | ...                                      | ...  | ...        |
| 62.124 | <a href="#">Data set 24 data 3 value</a> | Displays (in integer format) the data received from the external controller as word 3 of data set 24.<br>A target for this data can be selected by parameter <a href="#">62.74 Data set 24 data 3 selection</a> . The value can also be used as a source by another parameter. | 0          |
|        | 0...65535                                | Data received as word 3 of data set 24.  |            |



| No.    | Name/Value                                       | Description   | Def/FbEq16             |
|--------|--|---|------------------------|
| 62.151 | <a href="#">INU-LSU data set 11 data 1 sel</a>   | (Parameters <a href="#">62.151</a> ... <a href="#">62.203</a> only visible when supply unit control activated by <a href="#">95.20</a> )<br>Parameters <a href="#">62.151</a> ... <a href="#">62.153</a> define a target for the data received in data set 11 from another converter (typically the supply unit of the drive).<br>Parameters <a href="#">62.201</a> ... <a href="#">62.203</a> display the data received from the other converter in integer format, and can be used as sources by other parameters.<br>For example, this parameter selects a target for word 1 of data set 11. Parameter <a href="#">62.201 INU-LSU data set 11 data 1 value</a> displays the received data in integer format, and can also be used as a source by other parameters. | <a href="#">LSU SW</a> |
|        | None   | None.   | 0                      |
|        | LSU SW   | Status word of the supply unit.   | 4                      |
|        | <a href="#">Other</a>                            | Source selection (see <a href="#">Terms and abbreviations</a> on page 112).   | -                      |
| 62.152 | <a href="#">INU-LSU data set 11 data 2 sel</a>   | Defines a target for the data received as word 2 of data set 11. See also parameter <a href="#">62.202 INU-LSU data set 11 data 2 value</a> . For the selections, see parameter <a href="#">62.151 INU-LSU data set 11 data 1 sel</a> .   | <a href="#">None</a>   |
| 62.153 | <a href="#">INU-LSU data set 11 data 3 sel</a>   | Defines a target for the data received as word 3 of data set 11. See also parameter <a href="#">62.203 INU-LSU data set 11 data 3 value</a> . For the selections, see parameter <a href="#">62.151 INU-LSU data set 11 data 1 sel</a> .   | <a href="#">None</a>   |
| 62.201 | <a href="#">INU-LSU data set 11 data 1 value</a> | Displays (in integer format) the data received from the other converter as word 1 of data set 11.<br>A target for this data can be selected by parameter <a href="#">62.151 INU-LSU data set 11 data 1 sel</a> . The value can also be used as a source by another parameter.   | 0                      |
|        | 0...65535  | Data received as word 1 of data set 11.   |                        |
| 62.202 | <a href="#">INU-LSU data set 11 data 2 value</a> | Displays (in integer format) the data received from the other converter as word 2 of data set 11.<br>A target for this data can be selected by parameter <a href="#">62.152 INU-LSU data set 11 data 2 sel</a> . The value can also be used as a source by another parameter.   | 0                      |
|        | 0...65535  | Data received as word 2 of data set 11.   |                        |
| 62.203 | <a href="#">INU-LSU data set 11 data 3 value</a> | Displays (in integer format) the data received from the other converter as word 3 of data set 11.<br>A target for this data can be selected by parameter <a href="#">62.153 INU-LSU data set 11 data 3 sel</a> . The value can also be used as a source by another parameter.   | 0                      |
|        | 0...65535  | Data received as word 3 of data set 11.   |                        |

| No.                          | Name/Value                       | Description  | Def/FbEq16                     |
|------------------------------|----------------------------------|--|--------------------------------|
| <b>90 Feedback selection</b> |                                  |  |                                |
| 90.01                        | <i>Motor speed for control</i>   | <p>Displays the estimated or measured motor speed that is used for motor control, ie. final motor speed feedback selected by parameter <a href="#">90.41 Motor feedback selection</a> and filtered by <a href="#">90.42 Motor speed filter time</a>.</p> <p>In case measured feedback is selected, it is also scaled by the motor gear function (<a href="#">90.43 Motor gear numerator</a> and <a href="#">90.44 Motor gear denominator</a>).</p> <p>This parameter is read-only.</p>   | -                              |
|                              | -32768.00 ...<br>32767.00 rpm    | Motor speed used for control.  | See par. <a href="#">46.01</a> |
| 90.02                        | <i>Motor position</i>            | <p>Displays the motor position (within one revolution) received from the source selected by parameter <a href="#">90.41 Motor feedback selection</a>.</p> <p>In case measured feedback is selected, it is also scaled by the motor gear function (<a href="#">90.43 Motor gear numerator</a> and <a href="#">90.44 Motor gear denominator</a>).</p> <p>This parameter is read-only.</p>  | -                              |
|                              | 0.00000000 ...<br>1.00000000 rev | Motor position.  | 32767 =<br>1 rev               |
| 90.03                        | <i>Load speed</i>                | <p>Displays the estimated or measured load speed that is used for motor control, ie. final load speed feedback selected by parameter <a href="#">90.51 Load feedback selection</a> and filtered by parameter <a href="#">90.52 Load speed filter time</a>.</p> <p>In case measured feedback is selected, it is also scaled by the load gear function (<a href="#">90.53 Load gear numerator</a> and <a href="#">90.54 Load gear denominator</a>).</p> <p>In case motor feedback or estimated feedback is used, it is inversely scaled by <a href="#">90.61 Gear numerator</a> and <a href="#">90.62 Gear denominator</a> (ie. <a href="#">90.62</a> divided by <a href="#">90.61</a>).</p> <p>This parameter is read-only.</p>   | -                              |
|                              | -32768.00 ...<br>32767.00 rpm    | Load speed.  | See par. <a href="#">46.01</a> |
| 90.04                        | <i>Load position</i>             | <p>Displays the load position received from the source selected by parameter <a href="#">90.51 Load feedback selection</a>. The value is multiplied as specified by parameter <a href="#">90.57 Load position resolution</a>.</p> <p>In case measured feedback is selected, it is also scaled by the load gear function (<a href="#">90.53 Load gear numerator</a> and <a href="#">90.54 Load gear denominator</a>).</p> <p>In case motor feedback or estimated feedback is used, it is inversely scaled by <a href="#">90.61 Gear numerator</a> and <a href="#">90.62 Gear denominator</a> (ie. <a href="#">90.62</a> divided by <a href="#">90.61</a>).</p> <p>An offset can be defined by <a href="#">90.56 Load position offset</a>.</p> <p>This parameter is read-only.</p> | -                              |
|                              | -2147483648 ...<br>2147483647    | Load position.   | -                              |

| No.   | Name/Value                             | Description  | Def/FbEq16                     |
|-------|--|--|--------------------------------|
| 90.05 | <i>Load position scaled</i>            | Displays the scaled load position in decimal format. The position is relative to the initial position set by parameters <a href="#">90.65</a> and <a href="#">90.66</a> .<br>The number of decimal places is defined by parameter <a href="#">90.38 Pos counter decimals</a> .<br><b>Note:</b> This is a floating point parameter, and the accuracy is compromised near the ends of the range. Consider using parameter <a href="#">90.07 Load position scaled int</a> instead of this parameter.<br>This parameter is read-only.  | -                              |
|       | -2147483.648 ...<br>2147483.647        | Scaled load position in decimal format.  | -                              |
| 90.06 | <i>Motor position scaled</i>           | Displays the calculated motor position.<br>The axis mode (linear or rollover) and resolution are defined by parameters <a href="#">90.48 Motor position axis mode</a> and <a href="#">90.49 Motor position resolution</a> respectively.<br><b>Note:</b> The position value can be sent on a fast time level to the fieldbus controller by selecting <i>Position</i> in either <a href="#">50.07 FBA A actual 1 type</a> , <a href="#">50.08 FBA A actual 2 type</a> , <a href="#">50.37 FBA B actual 1 type</a> or <a href="#">50.38 FBA B actual 2 type</a> .<br>This parameter is read-only. | -                              |
|       | -2147483.648 ...<br>2147483.647        | Motor position.  | -                              |
| 90.07 | <i>Load position scaled int</i>        | Displays the output of the position counter function as an integer, enabling backwards compatibility with ACS 600 and ACS800 drives. The position is relative to the initial position set by parameters <a href="#">90.58</a> and <a href="#">90.59</a> . See section <a href="#">Position counter</a> (page 51), and the block diagram on page 568.<br>This parameter is read-only.   | -                              |
|       | -2147483648 ...<br>2147483647          | Scaled load position in integer format.  | -                              |
| 90.10 | <i>Encoder 1 speed</i>                 | Displays encoder 1 speed in rpm.<br>This parameter is read-only.   | -                              |
|       | -32768.00 ...<br>32767.00 rpm          | Encoder 1 speed.   | See par. <a href="#">46.01</a> |
| 90.11 | <i>Encoder 1 position</i>              | Displays the actual position of encoder 1 within one revolution.<br>This parameter is read-only.   | -                              |
|       | 0.00000000 ...<br>1.00000000 rev       | Encoder 1 position within one revolution.  | 32767 =<br>1 rev               |
| 90.12 | <i>Encoder 1 multiturn revolutions</i> | Displays the revolutions of (multiturn) encoder 1 within its value range (see parameter <a href="#">92.14 Revolution data width</a> ).<br>This parameter is read-only.   | -                              |
|       | 0...16777215                           | Encoder 1 revolutions.   | -                              |

| No.   | Name/Value                                      | Description  | Def/FbEq16                     |
|-------|---|--|--------------------------------|
| 90.13 | <a href="#">Encoder 1 revolution extension</a>  | Displays the revolution count extension for encoder 1.<br>With a single-turn encoder, the counter is incremented when encoder position (parameter <a href="#">90.11</a> ) wraps around in the positive direction, and decremented in the negative direction.<br>With a multiturn encoder, the counter is incremented when the revolutions count (parameter <a href="#">90.12</a> ) exceeds the value range in the positive direction, and decremented in the negative direction.<br>This parameter is read-only. | -                              |
|       | -2147483648 ...<br>2147483647                   | Encoder 1 revolution count extension.  | -                              |
| 90.14 | <a href="#">Encoder 1 position raw</a>          | Displays the raw measurement data of encoder 1 position (within one revolution) as a 24-bit unsigned integer received from the encoder interface.<br>This parameter is read-only.  | -                              |
|       | 0...16777215                                    | Raw encoder 1 position within one revolution.  | -                              |
| 90.15 | <a href="#">Encoder 1 revolutions raw</a>       | Displays the revolutions of (multiturn) encoder 1 within its value range (see parameter <a href="#">92.14 Revolution data width</a> ) as a raw measurement.<br>This parameter is read-only.  | -                              |
|       | 0...16777215                                    | Raw encoder 1 revolution count.  | -                              |
| 90.20 | <a href="#">Encoder 2 speed</a>                 | Displays encoder 2 speed in rpm.<br>This parameter is read-only.   | -                              |
|       | -32768.00 ...<br>32767.00 rpm                   | Encoder 2 speed.   | See par. <a href="#">46.01</a> |
| 90.21 | <a href="#">Encoder 2 position</a>              | Displays the actual position of encoder 2 within one revolution.<br>This parameter is read-only.   | -                              |
|       | 0.00000000 ...<br>1.00000000 rev                | Encoder 2 position within one revolution.  | -                              |
| 90.22 | <a href="#">Encoder 2 multiturn revolutions</a> | Displays the revolutions of (multiturn) encoder 2 within its value range (see parameter <a href="#">93.14 Revolution data width</a> ).<br>This parameter is read-only.   | -                              |
|       | 0...16777215                                    | Encoder 2 revolutions.   | -                              |
| 90.23 | <a href="#">Encoder 2 revolution extension</a>  | Displays the revolution count extension for encoder 2.<br>With a single-turn encoder, the counter is incremented when encoder position (parameter <a href="#">90.21</a> ) wraps around in the positive direction, and decremented in the negative direction.<br>With a multiturn encoder, the counter is incremented when the revolutions count (parameter <a href="#">90.22</a> ) exceeds the value range in the positive direction, and decremented in the negative direction.<br>This parameter is read-only. | -                              |
|       | -2147483648 ...<br>2147483647                   | Encoder 2 revolution count extension.  | -                              |
| 90.24 | <a href="#">Encoder 2 position raw</a>          | Displays the raw measurement data of of encoder 2 position (within one revolution) as a 24-bit unsigned integer received from the encoder interface.<br>This parameter is read-only.   | -                              |
|       | 0...16777215                                    | Raw encoder 2 position within one revolution.  | -                              |

| No.    | Name/Value                                 | Description  | Def/FbEq16 |      |       |   |                    |  |   |                    |  |   |                            |  |   |                |   |   |                        |   |   |                                   |  |   |                          |  |        |          |  |  |
|--------|--|--|------------|------|-------|---|--------------------|--|---|--------------------|--|---|----------------------------|--|---|----------------|---|---|------------------------|---|---|-----------------------------------|--|---|--------------------------|--|--------|----------|--|--|
| 90.25  | <a href="#">Encoder 2 revolutions raw</a>  | Displays the revolutions of (multiturn) encoder 2 within its value range (see parameter <a href="#">93.14 Revolution data width</a> ) as a raw measurement.<br>This parameter is read-only.  | -          |      |       |   |                    |  |   |                    |  |   |                            |  |   |                |   |   |                        |   |   |                                   |  |   |                          |  |        |          |  |  |
|        | 0...16777215                               | Raw encoder 2 revolution count.  | -          |      |       |   |                    |  |   |                    |  |   |                            |  |   |                |   |   |                        |   |   |                                   |  |   |                          |  |        |          |  |  |
| 90.26  | <a href="#">Motor revolution extension</a> | Displays the motor revolution count extension.<br>The counter is incremented when the position selected by <a href="#">90.41 Motor feedback selection</a> wraps around in the positive direction, and decremented in the negative direction.<br>This parameter is read-only.   | -          |      |       |   |                    |  |   |                    |  |   |                            |  |   |                |   |   |                        |   |   |                                   |  |   |                          |  |        |          |  |  |
|        | -2147483648 ...<br>2147483647              | Motor revolution count extension.  | -          |      |       |   |                    |  |   |                    |  |   |                            |  |   |                |   |   |                        |   |   |                                   |  |   |                          |  |        |          |  |  |
| 90.27  | <a href="#">Load revolution extension</a>  | Displays the load revolution count extension.<br>The counter is incremented when the position selected by <a href="#">90.51 Load feedback selection</a> wraps around in the positive direction, and decremented in the negative direction.<br>This parameter is read-only.   | -          |      |       |   |                    |  |   |                    |  |   |                            |  |   |                |   |   |                        |   |   |                                   |  |   |                          |  |        |          |  |  |
|        | -2147483648 ...<br>2147483647              | Load revolution count extension.   | -          |      |       |   |                    |  |   |                    |  |   |                            |  |   |                |   |   |                        |   |   |                                   |  |   |                          |  |        |          |  |  |
| 90.35  | <a href="#">Pos counter status</a>         | Status information related to the position counter function.<br>See section <a href="#">Position counter</a> (page 51).<br>This parameter is read-only.  | -          |      |       |   |                    |  |   |                    |  |   |                            |  |   |                |   |   |                        |   |   |                                   |  |   |                          |  |        |          |  |  |
|        |  | <table border="1"> <thead> <tr> <th>Bit</th> <th>Name</th> <th>Value</th> </tr> </thead> <tbody> <tr> <td>0</td> <td>Encoder 1 feedback</td> <td>1 = Encoder 1 selected as load feedback source</td> </tr> <tr> <td>1</td> <td>Encoder 2 feedback</td> <td>1 = Encoder 2 selected as load feedback source</td> </tr> <tr> <td>2</td> <td>Internal position feedback</td> <td>1 = Internal load position estimate selected as load feedback source</td> </tr> <tr> <td>3</td> <td>Motor feedback</td> <td>1 = Motor feedback selected as load feedback source</td> </tr> <tr> <td>4</td> <td>Pos counter init ready</td> <td>0 = Position counter not initialized, or encoder feedback was lost.<br/>Fresh counter initialization recommended.<br/>1 = Position counter successfully initialized</td> </tr> <tr> <td>5</td> <td>Position counter re-init disabled</td> <td>1 = Position counter initialization is being prevented by par. <a href="#">90.68</a></td> </tr> <tr> <td>6</td> <td>Position data inaccurate</td> <td>1 = Encoder feedback intermittent or lost. (If the drive is running, estimated position is used whenever encoder feedback is unavailable. If the drive is in stopped state, position counting will continue based on encoder data after the connection is restored.)</td> </tr> <tr> <td>7...15</td> <td>Reserved</td> <td></td> </tr> </tbody> </table> | Bit        | Name | Value | 0 | Encoder 1 feedback | 1 = Encoder 1 selected as load feedback source | 1 | Encoder 2 feedback | 1 = Encoder 2 selected as load feedback source | 2 | Internal position feedback | 1 = Internal load position estimate selected as load feedback source | 3 | Motor feedback | 1 = Motor feedback selected as load feedback source | 4 | Pos counter init ready | 0 = Position counter not initialized, or encoder feedback was lost.<br>Fresh counter initialization recommended.<br>1 = Position counter successfully initialized | 5 | Position counter re-init disabled | 1 = Position counter initialization is being prevented by par. <a href="#">90.68</a> | 6 | Position data inaccurate | 1 = Encoder feedback intermittent or lost. (If the drive is running, estimated position is used whenever encoder feedback is unavailable. If the drive is in stopped state, position counting will continue based on encoder data after the connection is restored.) | 7...15 | Reserved |  |  |
| Bit    | Name                                       | Value  |            |      |       |   |                    |  |   |                    |  |   |                            |  |   |                |   |   |                        |   |   |                                   |  |   |                          |  |        |          |  |  |
| 0      | Encoder 1 feedback                         | 1 = Encoder 1 selected as load feedback source   |            |      |       |   |                    |  |   |                    |  |   |                            |  |   |                |   |   |                        |   |   |                                   |  |   |                          |  |        |          |  |  |
| 1      | Encoder 2 feedback                         | 1 = Encoder 2 selected as load feedback source   |            |      |       |   |                    |  |   |                    |  |   |                            |  |   |                |   |   |                        |   |   |                                   |  |   |                          |  |        |          |  |  |
| 2      | Internal position feedback                 | 1 = Internal load position estimate selected as load feedback source   |            |      |       |   |                    |  |   |                    |  |   |                            |  |   |                |   |   |                        |   |   |                                   |  |   |                          |  |        |          |  |  |
| 3      | Motor feedback                             | 1 = Motor feedback selected as load feedback source  |            |      |       |   |                    |  |   |                    |  |   |                            |  |   |                |   |   |                        |   |   |                                   |  |   |                          |  |        |          |  |  |
| 4      | Pos counter init ready                     | 0 = Position counter not initialized, or encoder feedback was lost.<br>Fresh counter initialization recommended.<br>1 = Position counter successfully initialized  |            |      |       |   |                    |  |   |                    |  |   |                            |  |   |                |   |   |                        |   |   |                                   |  |   |                          |  |        |          |  |  |
| 5      | Position counter re-init disabled          | 1 = Position counter initialization is being prevented by par. <a href="#">90.68</a>   |            |      |       |   |                    |  |   |                    |  |   |                            |  |   |                |   |   |                        |   |   |                                   |  |   |                          |  |        |          |  |  |
| 6      | Position data inaccurate                   | 1 = Encoder feedback intermittent or lost. (If the drive is running, estimated position is used whenever encoder feedback is unavailable. If the drive is in stopped state, position counting will continue based on encoder data after the connection is restored.)   |            |      |       |   |                    |  |   |                    |  |   |                            |  |   |                |   |   |                        |   |   |                                   |  |   |                          |  |        |          |  |  |
| 7...15 | Reserved                                   |  |            |      |       |   |                    |  |   |                    |  |   |                            |  |   |                |   |   |                        |   |   |                                   |  |   |                          |  |        |          |  |  |
|        | 0000 0000b ...<br>0111 1111b               | Position counter status word.  | 1 = 1      |      |       |   |                    |  |   |                    |  |   |                            |  |   |                |   |   |                        |   |   |                                   |  |   |                          |  |        |          |  |  |

| No.   | Name/Value                      | Description  | Def/FbEq16      |
|-------|---------------------------------|--|-----------------|
| 90.38 | <i>Pos counter decimals</i>     | Scales the values of parameters <i>90.05 Load position scaled</i> and <i>90.65 Pos counter init value</i> when written from or read to from an external source (eg. fieldbus). The setting corresponds to the number of decimal places.<br>For example, with the setting of 3, an integer value of 66770 written into <i>90.65 Pos counter init value</i> is divided by 1000, so the final value applied will be 66.770. Likewise, the value of <i>90.05 Load position scaled</i> is multiplied by 1000 when read. | 3               |
|       | 0...9                           | Number of position counter decimal places.   | 1 = 1           |
| 90.41 | <i>Motor feedback selection</i> | Selects the motor speed feedback value used during motor control.<br><b>Note:</b> With a permanent magnet motor, make sure an autophasing routine (see page 59) is performed using the selected encoder. If necessary, set parameter <i>99.13 ID run requested</i> to <i>Autophasing</i> to request a fresh autophasing routine.   | <i>Estimate</i> |
|       | Estimate                        | A calculated speed estimate generated from the DTC core is used.   | 0               |
|       | Encoder 1                       | Actual speed measured by encoder 1. The encoder is set up by the parameters in group <i>92 Encoder 1 configuration</i> .   | 1               |
|       | Encoder 2                       | Actual speed measured by encoder 2. The encoder is set up by the parameters in group <i>93 Encoder 2 configuration</i> .   | 2               |
| 90.42 | <i>Motor speed filter time</i>  | Defines a filter time for motor speed feedback used for control ( <i>90.01 Motor speed for control</i> ).  | 3 ms            |
|       | 0 ... 10000 ms                  | Motor speed filter time.   | 1 = 1 ms        |
| 90.43 | <i>Motor gear numerator</i>     | Parameters <i>90.43</i> and <i>90.44</i> define a gear function between the motor speed feedback and motor control. The gear is used to correct a difference between the motor and encoder speeds for example if the encoder is not mounted directly on the motor shaft.<br><br>$\frac{\text{90.43 Motor gear numerator}}{\text{90.44 Motor gear denominator}} = \frac{\text{Motor speed}}{\text{Encoder speed}}$  | 1               |
|       | -2147483648 ...<br>2147483647   | Motor gear numerator.  | -               |
| 90.44 | <i>Motor gear denominator</i>   | See parameter <i>90.43 Motor gear numerator</i> .  | 1               |
|       | -2147483648 ...<br>2147483647   | Motor gear denominator.  | -               |
| 90.45 | <i>Motor feedback fault</i>     | Selects how the drive reacts to loss of measured motor feedback.   | <i>Fault</i>    |
|       | Fault                           | Drive trips on a <i>7301 Motor speed feedback</i> or <i>7381 Encoder</i> fault.  | 0               |
|       | Warning                         | Drive generates an <i>A798 Encoder option comm loss</i> , <i>A7B0 Motor speed feedback</i> or <i>A7E1 Encoder</i> warning and continues operation using estimated feedbacks.<br><b>Note:</b> Before using this setting, test the stability of the speed control loop with estimated feedback by running the drive on estimated feedback (see <i>90.41 Motor feedback selection</i> ).  | 1               |

| No.   | Name/Value                       | Description   | Def/FbEq16 |
|-------|----------------------------------|---|------------|
| 90.46 | <i>Force open loop</i>           | Forces the DTC motor model to use estimated motor speed as feedback. This parameter can be activated when the encoder data is obviously unreliable because of slippage, for example.<br><b>Note:</b> This parameter only affects the selection of feedback for the motor model, not for the speed controller.   | No         |
|       | No                               | The motor model uses the feedback selected by <a href="#">90.41 Motor feedback selection</a> .  | 0          |
|       | Yes                              | The motor model uses the calculated speed estimate (regardless of the setting of <a href="#">90.41 Motor feedback selection</a> , which in this case only selects the source of feedback for the speed controller).   | 1          |
| 90.48 | <i>Motor position axis mode</i>  | Selects the axis type for motor position measurement.   | Rollover   |
|       | Linear                           | Linear.   | 0          |
|       | Rollover                         | The value is between 0 and 1 revolutions, and rolls over at 360 degrees.  | 1          |
| 90.49 | <i>Motor position resolution</i> | Defines how many bits are used for motor position count within one revolution. For example, with the setting of 24, the position value is multiplied by 16777216 for display in parameter <a href="#">90.06 Motor position scaled</a> (or for fieldbus).  | 24         |
|       | 0...31                           | Motor position resolution.  | -          |
| 90.51 | <i>Load feedback selection</i>   | Selects the source of load speed and position feedbacks used in control.  | None       |
|       | None                             | No load feedback selected.  | 0          |
|       | Encoder 1                        | Load feedbacks are updated based on the speed and position values read from encoder 1.<br>The values are scaled by the load gear function ( <a href="#">90.53 Load gear numerator</a> and <a href="#">90.54 Load gear denominator</a> ).<br>The encoder is set up by the parameters in group <a href="#">92 Encoder 1 configuration</a> .   | 1          |
|       | Encoder 2                        | Load feedbacks are updated based on the speed and position values read from encoder 2.<br>The values are scaled by the load gear function ( <a href="#">90.53 Load gear numerator</a> and <a href="#">90.54 Load gear denominator</a> ).<br>The encoder is set up by the parameters in group <a href="#">93 Encoder 2 configuration</a> .   | 2          |
|       | Estimate                         | Calculated speed and position estimates are used. The values are scaled from the motor side to the load side using the inverted ratio between <a href="#">90.61 Gear numerator</a> and <a href="#">90.62 Gear denominator</a> (ie. <a href="#">90.62</a> divided by <a href="#">90.61</a> ).  | 3          |
|       | Motor feedback                   | The source selected by parameter <a href="#">90.41 Motor feedback selection</a> for motor feedback is also used for load feedback. Any difference between the motor and load speeds (and positions) can be compensated by using the inverted ratio between <a href="#">90.61 Gear numerator</a> and <a href="#">90.62 Gear denominator</a> (ie. <a href="#">90.62</a> divided by <a href="#">90.61</a> ). | 4          |
| 90.52 | <i>Load speed filter time</i>    | Defines a filter time for load speed feedback ( <a href="#">90.03 Load speed</a> ).   | 4 ms       |
|       | 0 ... 10000 ms                   | Load speed filter time.   | -          |



| No.   | Name/Value                               | Description   | Def/FbEq16                        |
|-------|--|---|-----------------------------------|
| 90.53 | <i>Load gear numerator</i>               | Parameters 90.53 and 90.54 define a gear function between the load (ie. driven equipment) speed and the encoder feedback selected by parameter 90.51 <i>Load feedback selection</i> . The gear can be used to correct a difference between the load and encoder speeds for example if the encoder is not mounted directly on the rotated machinery.<br><br>$\frac{90.53 \text{ Load gear numerator}}{90.54 \text{ Load gear denominator}} = \frac{\text{Load speed}}{\text{Encoder speed}}$ | 1                                 |
|       | -2147483648 ...<br>2147483647            | Load gear numerator.  | -                                 |
| 90.54 | <i>Load gear denominator</i>             | See parameter 90.53 <i>Load gear numerator</i> .  | 1                                 |
|       | -2147483648 ...<br>2147483647            | Load gear denominator.  | -                                 |
| 90.55 | <i>Load feedback fault</i>               | Selects how the drive reacts to loss of load feedback.  | <i>Fault</i>                      |
|       | Fault                                    | Drive trips on a 73A1 <i>Load feedback</i> fault.   | 0                                 |
|       | Warning                                  | Drive generates an A798 <i>Encoder option comm loss</i> or A7B1 <i>Load speed feedback</i> warning and continues operation using estimated feedbacks.   | 1                                 |
| 90.56 | <i>Load position offset</i>              | Defines a load-side position offset. The resolution is determined by parameter 90.57 <i>Load position resolution</i> .  | 0 rev                             |
|       | -2147483648 ...<br>2147483647 rev        | Load-side position offset.  | -                                 |
| 90.57 | <i>Load position resolution</i>          | Defines how many bits are used for load position count within one revolution. For example, with the setting of 16, the position value is multiplied by 65536 for display in parameter 90.04 <i>Load position</i> .  | 16                                |
|       | 0...31                                   | Load position resolution.   | -                                 |
| 90.58 | <i>Pos counter init value int</i>        | Defines an initial position (or distance) for the position counter (as an integer value) when parameter 90.59 <i>Pos counter init value int source</i> is set to <i>Pos counter init value int</i> . See also section <i>Position counter</i> (page 51).  | 0                                 |
|       | -2147483648 ...<br>2147483647            | Initial integer value for position counter.   | -                                 |
| 90.59 | <i>Pos counter init value int source</i> | Selects the source of the initial position integer value. When the source selected by 90.67 <i>Pos counter init cmd source</i> activates, the value selected in this parameter is assumed to be the position of the load.   | <i>Pos counter init value int</i> |
|       | Zero                                     | 0.  | 0                                 |
|       | Pos counter init value int               | Parameter 90.58 <i>Pos counter init value int</i> .   | 1                                 |
|       | <i>Other</i>                             | Source selection (see <i>Terms and abbreviations</i> on page 112).  | -                                 |
| 90.60 | <i>Pos counter error and boot action</i> | Selects how the position counter reacts to loss of load feedback.   | <i>Request re-initialization</i>  |
|       | Request re-initialization                | Bit 4 of 90.35 <i>Pos counter status</i> is cleared. Reinitialization of position counter is recommended.   | 0                                 |



| No.                   | Name/Value                                    | Description   | Def/FbEq16                             |
|-----------------------|---|---|--|
|                       | Continue from previous value                  | Position counting resumes from the previous value over a loss of load feedback or control unit reboot. Bit 4 of <a href="#">90.35 Pos counter status</a> is not cleared, but bit 6 is set to indicate that an error has occurred.<br> <b>WARNING!</b> If load feedback is lost when the drive is in stopped state or not powered, the counter is not updated even if the load moves.   | 1                                      |
| <a href="#">90.61</a> | <a href="#">Gear numerator</a>                | Parameters <a href="#">90.61</a> and <a href="#">90.62</a> define a gear function between the motor and load speeds.<br>$\frac{\text{90.61 Gear numerator}}{\text{90.62 Gear denominator}} = \frac{\text{Motor speed}}{\text{Load speed}}$  | 1                                      |
|                       | -2147483648 ...<br>2147483647                 | Gear numerator (motor-side).  | -                                      |
| <a href="#">90.62</a> | <a href="#">Gear denominator</a>              | See parameter <a href="#">90.61 Gear numerator</a> .  | 1                                      |
|                       | -2147483648 ...<br>2147483647                 | Gear denominator (load-side).   | -                                      |
| <a href="#">90.63</a> | <a href="#">Feed constant numerator</a>       | Parameters <a href="#">90.63</a> and <a href="#">90.64</a> define the feed constant for the position calculation:<br>$\frac{\text{90.63 Feed constant numerator}}{\text{90.64 Feed constant denominator}}$<br>The feed constant converts rotational motion into translatory motion. The feed constant is the distance the load moves during one turn of the motor shaft.<br>The translatory load position is shown by parameter <a href="#">90.07 Load position scaled int</a> . Note that the load position is only updated after new position input data is received. | 1                                      |
|                       | -2147483648 ...<br>2147483647                 | Feed constant numerator.  | -                                      |
| <a href="#">90.64</a> | <a href="#">Feed constant denominator</a>     | See parameter <a href="#">90.63 Feed constant numerator</a> .   | 1                                      |
|                       | -2147483648 ...<br>2147483647                 | Feed constant denominator.  | -                                      |
| <a href="#">90.65</a> | <a href="#">Pos counter init value</a>        | Defines an initial position (or distance) for the position counter (as a decimal number) when parameter <a href="#">90.66 Pos counter init value source</a> is set to <a href="#">Pos counter init value</a> .<br>The number of decimal places is defined by parameter <a href="#">90.38 Pos counter decimals</a> .   | 0.000                                  |
|                       | -2147483.648 ...<br>2147483.647               | Initial value for position counter.   | -                                      |
| <a href="#">90.66</a> | <a href="#">Pos counter init value source</a> | Selects the source of the initial position value. When the source selected by <a href="#">90.67 Pos counter init cmd source</a> activates, the value selected in this parameter is assumed to be the position of the load (in decimal format).  | <a href="#">Pos counter init value</a> |
|                       | Zero  | 0.  | 0                                      |
|                       | Pos counter init value                        | Parameter <a href="#">90.65 Pos counter init value</a> .  | 1                                      |
|                       | <a href="#">Other</a>                         | Source selection (see <a href="#">Terms and abbreviations</a> on page 112).   | -                                      |

| No.   | Name/Value                                | Description   | Def/FbEq16          |
|-------|---|---|---------------------|
| 90.67 | <i>Pos counter init cmd source</i>        | Selects a digital source (for example, a limit switch connected to a digital input) that initializes the position counter. When the digital source activates, the value selected by <a href="#">90.66 Pos counter init value source</a> is assumed to be the position of the load.<br><b>Note:</b> Position counter initialization can be prevented by parameter <a href="#">90.68 Disable pos counter initialization</a> . | <i>Not selected</i> |
|       | Not selected                              | 0.  | 0                   |
|       | Selected                                  | 1.  | 1                   |
|       | DI1                                       | Digital input DI1 ( <a href="#">10.02 DI delayed status</a> , bit 0).   | 2                   |
|       | DI2                                       | Digital input DI2 ( <a href="#">10.02 DI delayed status</a> , bit 1).   | 3                   |
|       | DI3                                       | Digital input DI3 ( <a href="#">10.02 DI delayed status</a> , bit 2).   | 4                   |
|       | DI4                                       | Digital input DI4 ( <a href="#">10.02 DI delayed status</a> , bit 3).   | 5                   |
|       | DI5                                       | Digital input DI5 ( <a href="#">10.02 DI delayed status</a> , bit 4).   | 6                   |
|       | DI6                                       | Digital input DI6 ( <a href="#">10.02 DI delayed status</a> , bit 5).   | 7                   |
|       | DIO1                                      | Digital input/output DIO1 ( <a href="#">11.02 DIO delayed status</a> , bit 0).  | 10                  |
|       | DIO2                                      | Digital input/output DIO2 ( <a href="#">11.02 DIO delayed status</a> , bit 1).  | 11                  |
|       | <i>Other [bit]</i>                        | Source selection (see <a href="#">Terms and abbreviations</a> on page 112).   | -                   |
| 90.68 | <i>Disable pos counter initialization</i> | Selects a source that prevents the initialization of the position counter.  | <i>Not selected</i> |
|       | Not selected                              | 0.  | 0                   |
|       | Selected                                  | 1.  | 1                   |
|       | DI1                                       | Digital input DI1 ( <a href="#">10.02 DI delayed status</a> , bit 0).   | 2                   |
|       | DI2                                       | Digital input DI2 ( <a href="#">10.02 DI delayed status</a> , bit 1).   | 3                   |
|       | DI3                                       | Digital input DI3 ( <a href="#">10.02 DI delayed status</a> , bit 2).   | 4                   |
|       | DI4                                       | Digital input DI4 ( <a href="#">10.02 DI delayed status</a> , bit 3).   | 5                   |
|       | DI5                                       | Digital input DI5 ( <a href="#">10.02 DI delayed status</a> , bit 4).   | 6                   |
|       | DI6                                       | Digital input DI6 ( <a href="#">10.02 DI delayed status</a> , bit 5).   | 7                   |
|       | DIO1                                      | Digital input/output DIO1 ( <a href="#">11.02 DIO delayed status</a> , bit 0).  | 10                  |
|       | DIO2                                      | Digital input/output DIO2 ( <a href="#">11.02 DIO delayed status</a> , bit 1).  | 11                  |
|       | <i>Other [bit]</i>                        | Source selection (see <a href="#">Terms and abbreviations</a> on page 112).   | -                   |
| 90.69 | <i>Reset pos counter init ready</i>       | Selects a source that enables a new initialization of the position counter, ie. resets bit 4 of <a href="#">90.35 Pos counter status</a> .  | <i>Not selected</i> |
|       | Not selected                              | 0.  | 0                   |
|       | Selected                                  | 1.  | 1                   |
|       | DI1                                       | Digital input DI1 ( <a href="#">10.02 DI delayed status</a> , bit 0).   | 2                   |
|       | DI2                                       | Digital input DI2 ( <a href="#">10.02 DI delayed status</a> , bit 1).   | 3                   |
|       | DI3                                       | Digital input DI3 ( <a href="#">10.02 DI delayed status</a> , bit 2).   | 4                   |
|       | DI4                                       | Digital input DI4 ( <a href="#">10.02 DI delayed status</a> , bit 3).   | 5                   |
|       | DI5                                       | Digital input DI5 ( <a href="#">10.02 DI delayed status</a> , bit 4).   | 6                   |
|       | DI6                                       | Digital input DI6 ( <a href="#">10.02 DI delayed status</a> , bit 5).   | 7                   |
|       | DIO1                                      | Digital input/output DIO1 ( <a href="#">11.02 DIO delayed status</a> , bit 0).  | 10                  |
|       | DIO2                                      | Digital input/output DIO2 ( <a href="#">11.02 DIO delayed status</a> , bit 1).  | 11                  |
|       | <i>Other [bit]</i>                        | Source selection (see <a href="#">Terms and abbreviations</a> on page 112).   | -                   |

| No.   | Name/Value                   | Description   | Def/FbEq16 |     |      |             |   |               |   |   |               |   |       |          |  |   |               |   |   |               |   |        |          |  |
|---|------------------------------|---|------------|-----|------|-------------|---|---------------|---|---|---------------|---|-------|----------|--|---|---------------|---|---|---------------|---|--------|----------|--|
| <b>91 Encoder module settings</b>   |                              | Configuration of encoder interface modules.   |            |     |      |             |   |               |   |   |               |   |       |          |  |   |               |   |   |               |   |        |          |  |
| <b>91.01</b>  | <b>FEN DI status</b>         | Displays the status of the digital inputs of FEN-xx encoder interface modules.<br>This parameter is read-only.  | -          |     |      |             |   |               |   |   |               |   |       |          |  |   |               |   |   |               |   |        |          |  |
| <table border="1"> <thead> <tr> <th>Bit</th> <th>Name</th> <th>Information</th> </tr> </thead> <tbody> <tr> <td>0</td> <td>DI1 /module 1</td> <td>DI1 of interface module 1 (see parameters <a href="#">91.11</a> and <a href="#">91.12</a>)</td> </tr> <tr> <td>1</td> <td>DI2 /module 1</td> <td>DI2 of interface module 1 (see parameters <a href="#">91.11</a> and <a href="#">91.12</a>)</td> </tr> <tr> <td>2...3</td> <td colspan="2">Reserved</td> </tr> <tr> <td>4</td> <td>DI1 /module 2</td> <td>DI1 of interface module 2 (see parameters <a href="#">91.13</a> and <a href="#">91.14</a>)</td> </tr> <tr> <td>5</td> <td>DI2 /module 2</td> <td>DI2 of interface module 2 (see parameters <a href="#">91.13</a> and <a href="#">91.14</a>)</td> </tr> <tr> <td>6...15</td> <td colspan="2">Reserved</td> </tr> </tbody> </table> |                              |   |            | Bit | Name | Information | 0 | DI1 /module 1 | DI1 of interface module 1 (see parameters <a href="#">91.11</a> and <a href="#">91.12</a> ) | 1 | DI2 /module 1 | DI2 of interface module 1 (see parameters <a href="#">91.11</a> and <a href="#">91.12</a> ) | 2...3 | Reserved |  | 4 | DI1 /module 2 | DI1 of interface module 2 (see parameters <a href="#">91.13</a> and <a href="#">91.14</a> ) | 5 | DI2 /module 2 | DI2 of interface module 2 (see parameters <a href="#">91.13</a> and <a href="#">91.14</a> ) | 6...15 | Reserved |  |
| Bit   | Name                         | Information   |            |     |      |             |   |               |   |   |               |   |       |          |  |   |               |   |   |               |   |        |          |  |
| 0   | DI1 /module 1                | DI1 of interface module 1 (see parameters <a href="#">91.11</a> and <a href="#">91.12</a> )   |            |     |      |             |   |               |   |   |               |   |       |          |  |   |               |   |   |               |   |        |          |  |
| 1   | DI2 /module 1                | DI2 of interface module 1 (see parameters <a href="#">91.11</a> and <a href="#">91.12</a> )   |            |     |      |             |   |               |   |   |               |   |       |          |  |   |               |   |   |               |   |        |          |  |
| 2...3   | Reserved                     |   |            |     |      |             |   |               |   |   |               |   |       |          |  |   |               |   |   |               |   |        |          |  |
| 4   | DI1 /module 2                | DI1 of interface module 2 (see parameters <a href="#">91.13</a> and <a href="#">91.14</a> )   |            |     |      |             |   |               |   |   |               |   |       |          |  |   |               |   |   |               |   |        |          |  |
| 5   | DI2 /module 2                | DI2 of interface module 2 (see parameters <a href="#">91.13</a> and <a href="#">91.14</a> )   |            |     |      |             |   |               |   |   |               |   |       |          |  |   |               |   |   |               |   |        |          |  |
| 6...15  | Reserved                     |   |            |     |      |             |   |               |   |   |               |   |       |          |  |   |               |   |   |               |   |        |          |  |
|   | 0000 0000b ...<br>0011 0011b | Status word of digital inputs on FEN-xx modules.  | 1 = 1      |     |      |             |   |               |   |   |               |   |       |          |  |   |               |   |   |               |   |        |          |  |
| <b>91.02</b>  | <b>Module 1 status</b>       | Displays the type of the interface module found in the location specified by parameter <a href="#">91.12 Module 1 location</a> .<br>This parameter is read-only.  | -          |     |      |             |   |               |   |   |               |   |       |          |  |   |               |   |   |               |   |        |          |  |
|   | No option                    | No module detected in the specified slot.   | 0          |     |      |             |   |               |   |   |               |   |       |          |  |   |               |   |   |               |   |        |          |  |
|   | No communication             | A module has been detected but cannot be communicated with.   | 1          |     |      |             |   |               |   |   |               |   |       |          |  |   |               |   |   |               |   |        |          |  |
|   | Unknown                      | The module type is unknown.   | 2          |     |      |             |   |               |   |   |               |   |       |          |  |   |               |   |   |               |   |        |          |  |
|   | FEN-01                       | An FEN-01 module has been detected and is active.   | 16         |     |      |             |   |               |   |   |               |   |       |          |  |   |               |   |   |               |   |        |          |  |
|   | FEN-11                       | An FEN-11 module has been detected and is active.   | 17         |     |      |             |   |               |   |   |               |   |       |          |  |   |               |   |   |               |   |        |          |  |
|   | FEN-21                       | An FEN-21 module has been detected and is active.   | 18         |     |      |             |   |               |   |   |               |   |       |          |  |   |               |   |   |               |   |        |          |  |
|   | FEN-31                       | An FEN-31 module has been detected and is active.   | 21         |     |      |             |   |               |   |   |               |   |       |          |  |   |               |   |   |               |   |        |          |  |
|   | FSE-31                       | An FSE-31 module has been detected and is active.   | 25         |     |      |             |   |               |   |   |               |   |       |          |  |   |               |   |   |               |   |        |          |  |
| <b>91.03</b>  | <b>Module 2 status</b>       | Displays the type of the interface module found in the location specified by parameter <a href="#">91.14 Module 2 location</a> .<br>For the indications, see parameter <a href="#">91.02 Module 1 status</a> .<br>This parameter is read-only.  | -          |     |      |             |   |               |   |   |               |   |       |          |  |   |               |   |   |               |   |        |          |  |
| <b>91.04</b>  | <b>Module 1 temperature</b>  | Displays the temperature measured through the sensor input of interface module 1. The unit is selected by parameter <a href="#">96.16 Unit selection</a> .<br><b>Note:</b> With a PTC sensor, the unit is ohms.<br>This parameter is read-only. | -          |     |      |             |   |               |   |   |               |   |       |          |  |   |               |   |   |               |   |        |          |  |
|   | 0...1000 °C, °F or ohm       | Temperature measured through interface module 1.  | -          |     |      |             |   |               |   |   |               |   |       |          |  |   |               |   |   |               |   |        |          |  |
| <b>91.06</b>  | <b>Module 2 temperature</b>  | Displays the temperature measured through the sensor input of interface module 2. The unit is selected by parameter <a href="#">96.16 Unit selection</a> .<br><b>Note:</b> With a PTC sensor, the unit is ohms.<br>This parameter is read-only. | -          |     |      |             |   |               |   |   |               |   |       |          |  |   |               |   |   |               |   |        |          |  |
|   | 0...1000 °C, °F or ohm       | Temperature measured through interface module 2.  | -          |     |      |             |   |               |   |   |               |   |       |          |  |   |               |   |   |               |   |        |          |  |

| No.   | Name/Value                       | Description  | Def/FbEq16    |
|-------|----------------------------------|--|---------------|
| 91.10 | <i>Encoder parameter refresh</i> | Validates any changed encoder interface module parameters. This is needed for any parameter changes in groups 90...93 to take effect.<br>After refreshing, the value reverts automatically to <i>Done</i> .<br><b>Notes:</b> <ul style="list-style-type: none"> <li>Permanent magnet motors only: The drive will perform a fresh autophasing routine (see page 59) at next start if the motor feedback encoder settings have been changed.</li> <li>The parameter cannot be changed while the drive is running.</li> </ul> | <i>Done</i>   |
|       | Done                             | Refreshing done.   | 0             |
|       | Refresh                          | Refreshing.  | 1             |
| 91.11 | <i>Module 1 type</i>             | Defines the type of the module used as interface module 1.   | <i>None</i>   |
|       | None                             | None (communication disabled).   | 0             |
|       | FEN-01                           | FEN-01.  | 1             |
|       | FEN-11                           | FEN-11.  | 2             |
|       | FEN-21                           | FEN-21.  | 3             |
|       | FEN-31                           | FEN-31.  | 4             |
|       | FSE-31                           | FSE-31.  | 5             |
| 91.12 | <i>Module 1 location</i>         | Specifies the slot (1...3) on the control unit of the drive into which the interface module is installed. Alternatively, specifies the node ID of the slot on an FEA-03 extension adapter.   | <i>Slot 2</i> |
|       | Slot 1                           | Slot 1.  | 1             |
|       | Slot 2                           | Slot 2.  | 2             |
|       | Slot 3                           | Slot 3.  | 3             |
|       | 4...254                          | Node ID of the slot on the FEA-03 extension adapter.   | 1 = 1         |
| 91.13 | <i>Module 2 type</i>             | Defines the type of the module used as interface module 2.   | <i>None</i>   |
|       | None                             | None (communication disabled).   | 0             |
|       | FEN-01                           | FEN-01.  | 1             |
|       | FEN-11                           | FEN-11.  | 2             |
|       | FEN-21                           | FEN-21.  | 3             |
|       | FEN-31                           | FEN-31.  | 4             |
|       | FSE-31                           | FSE-31.  | 5             |
| 91.14 | <i>Module 2 location</i>         | Specifies the slot (1...3) on the control unit of the drive into which the interface module is installed. Alternatively, specifies the node ID of the slot on an FEA-03 extension adapter.   | <i>Slot 3</i> |
|       | Slot 1                           | Slot 1.  | 1             |
|       | Slot 2                           | Slot 2.  | 2             |
|       | Slot 3                           | Slot 3.  | 3             |
|       | 4...254                          | Node ID of the slot on the FEA-03 extension adapter.   | 1 = 1         |
| 91.21 | <i>Module 1 temp sensor type</i> | Specifies the type of temperature sensor connected to interface module 1. Note that the module must also be activated by parameters 91.11...91.12.   | <i>None</i>   |
|       | None                             | None.  | 0             |
|       | PTC                              | PTC. (The unit is ohms.)   | 1             |

| No.                   | Name/Value                                       | Description  | Def/FbEq16          |
|-----------------------|--|--|---------------------|
|                       | KTY-84   | KTY84. (The unit is selected by parameter <a href="#">96.16 Unit selection</a> .)  | 2                   |
| <a href="#">91.22</a> | <a href="#">Module 1 temp filter time</a>        | Defines a filtering time for the temperature measurement through interface module 1.   | 1500 ms             |
|                       | 0...10000 ms                                     | Filtering time for temperature measurement.  | -                   |
| <a href="#">91.24</a> | <a href="#">Module 2 temp sensor type</a>        | Specifies the type of temperature sensor connected to interface module 2. Note that the module must also be activated by parameters <a href="#">91.13</a> ... <a href="#">91.14</a> .  | <i>None</i>         |
|                       | None   | None.  | 0                   |
|                       | PTC  | PTC. (The unit is ohms.)   | 1                   |
|                       | KTY-84   | KTY84. (The unit is selected by parameter <a href="#">96.16 Unit selection</a> .)  | 2                   |
| <a href="#">91.25</a> | <a href="#">Module 2 temp filter time</a>        | Defines a filtering time for the temperature measurement through interface 2.  | 1500 ms             |
|                       | 0...10000 ms                                     | Filtering time for temperature measurement.  | -                   |
| <a href="#">91.31</a> | <a href="#">Module 1 TTL output source</a>       | Selects the encoder input on interface module 1 whose signal is echoed by or emulated to the TTL output. See also section <a href="#">Encoder support</a> (page 49).   | <i>Not selected</i> |
|                       | Not selected                                     | TTL output not in use.   | 0                   |
|                       | Module input 1                                   | Input 1 is echoed by or emulated to the TTL output.  | 1                   |
|                       | Module input 2                                   | Input 2 is echoed by or emulated to the TTL output.  | 2                   |
| <a href="#">91.32</a> | <a href="#">Module 1 emulation pulses/rev</a>    | Defines the number of TTL pulses per revolution for encoder emulation output of interface module 1.  | 0                   |
|                       | 0...65535  | Number of TTL pulses for emulation.  | 1 = 1               |
| <a href="#">91.33</a> | <a href="#">Module 1 emulated Z-pulse offset</a> | With interface module 1, defines when zero pulses are emulated in relation to zero position received from the encoder.<br>For example, with a value of 0.50000, a zero pulse is emulated whenever the encoder position passes 0.5 revolutions. With a value of 0.00000, a zero pulse is emulated whenever the encoder position passes zero position. | 0.00000             |
|                       | 0.00000 ... 1.00000 rev                          | Position of emulated zero pulses.  | 32767 = 1 rev       |
| <a href="#">91.41</a> | <a href="#">Module 2 TTL output source</a>       | Selects the encoder input on interface module 2 whose signal is echoed by or emulated to the TTL output. See also section <a href="#">Encoder support</a> (page 49).   | <i>Not selected</i> |
|                       | Not selected                                     | TTL output not in use.   | 0                   |
|                       | Module input 1                                   | Input 1 is echoed by or emulated to the TTL output.  | 1                   |
|                       | Module input 2                                   | Input 2 is echoed by or emulated to the TTL output.  | 2                   |
| <a href="#">91.42</a> | <a href="#">Module 2 emulation pulses/rev</a>    | Defines the number of TTL pulses per revolution for encoder emulation output of interface module 2.  | 0                   |
|                       | 0...65535  | Number of TTL pulses for emulation.  | 1 = 1               |

| No.                               | Name/Value                              | Description   | Def/FbEq16             |
|-----------------------------------|---|---|------------------------|
| 91.43                             | <i>Module 2 emulated Z-pulse offset</i> | With interface module 2, defines when zero pulses are emulated in relation to zero position received from the encoder.<br>For example, with a value of 0.50000, a zero pulse is emulated whenever the encoder position passes 0.5 revolutions. With a value of 0.00000, a zero pulse is emulated whenever the encoder position passes zero position.  | 0                      |
|                                   | 0.00000 ... 1.00000 rev                 | Position of emulated zero pulses.   | 32767 = 1 rev          |
| <b>92 Encoder 1 configuration</b> |   |   |                        |
|                                   |   | Settings for encoder 1.<br><b>Notes:</b> <ul style="list-style-type: none"> <li>The contents of the parameter group vary according to the selected encoder type.</li> <li>It is recommended that encoder connection 1 (this group) is used whenever possible since the data received through that interface is fresher than the data received through connection 2 (group <a href="#">93 Encoder 2 configuration</a>).</li> </ul> |                        |
| 92.01                             | <i>Encoder 1 type</i>                   | Selects the type of encoder/resolver 1.   | <i>None configured</i> |
|                                   | None configured                         | None.   | 0                      |
|                                   | TTL                                     | TTL. Module type (input): FEN-01 (X31), FEN-11 (X41) or FEN-21 (X51).   | 1                      |
|                                   | TTL+                                    | TTL+. Module type (input): FEN-01 (X32).  | 2                      |
|                                   | Absolute encoder                        | Absolute encoder. Module type (input): FEN-11 (X42).  | 3                      |
|                                   | Resolver                                | Resolver. Module type (input): FEN-21 (X52).  | 4                      |
|                                   | HTL                                     | HTL. Module type (input): FEN-31 (X82).   | 5                      |
|                                   | HTL 1                                   | HTL. Module type (input): FSE-31 (X31).   | 6                      |
|                                   | HTL 2                                   | HTL. Module type (input): FSE-31 (X32). Not supported at the time of publication.   | 7                      |
| 92.02                             | <i>Encoder 1 source</i>                 | Selects the interface module that the encoder is connected to. (The physical locations and types of encoder interface modules are defined in parameter group <a href="#">91 Encoder module settings</a> .)  | <i>Module 1</i>        |
|                                   | Module 1                                | Interface module 1.   | 0                      |
|                                   | Module 2                                | Interface module 2.   | 1                      |
| 92.10                             | <i>Pulses/revolution</i>                | (Visible when a TTL, TTL+ or HTL encoder is selected)<br>Defines the pulse number per revolution.   | 2048                   |
|                                   | 0...65535                               | Number of pulses.   | -                      |
| 92.10                             | <i>Sine/cosine number</i>               | (Visible when an absolute encoder is selected)<br>Defines the number of sine/cosine wave cycles within one revolution.<br><b>Note:</b> This parameter need not be set when an EnDat or SSI encoder is used in continuous mode. See parameter <a href="#">92.30 Serial link mode</a> .   | 0                      |
|                                   | 0...65535                               | Number of sine/cosine wave cycles within one revolution.  | -                      |

| No.                               | Name/Value                                  | Description   | Def/FbEq16                        |           |           |                             |                |                       |           |                          |  |
|-----------------------------------|---|---|-----------------------------------|-----------|-----------|-----------------------------|----------------|-----------------------|-----------|--------------------------|--|
| 92.10                             | <a href="#">Excitation signal frequency</a> | (Visible when a resolver is selected)<br>Defines the frequency of the excitation signal.<br><b>Note:</b> With an EnDat or HIPERFACE encoder and FEN-11 FPGA version VIE12200 or later, this parameter is automatically set upon validation of encoder settings ( <a href="#">92.10 Encoder parameter refresh</a> ).                               | 1 kHz                             |           |           |                             |                |                       |           |                          |  |
|                                   | 1...20 kHz                                  | Excitation signal frequency.  | 1 = 1 kHz                         |           |           |                             |                |                       |           |                          |  |
| 92.11                             | <a href="#">Pulse encoder type</a>          | (Visible when a TTL, TTL+ or HTL encoder is selected)<br>Selects the type of encoder.   | <a href="#">Quadrature</a>        |           |           |                             |                |                       |           |                          |  |
|                                   | Quadrature                                  | Quadrature encoder (with two channels, A and B)   | 0                                 |           |           |                             |                |                       |           |                          |  |
|                                   | Single track                                | Single-track encoder (with one channel, A).<br><b>Note:</b> With this setting, the measured speed value is always positive regardless of direction of rotation.   | 1                                 |           |           |                             |                |                       |           |                          |  |
| 92.11                             | <a href="#">Absolute position source</a>    | (Visible when an absolute encoder is selected)<br>Selects the source of the absolute position information.  | <a href="#">None</a>              |           |           |                             |                |                       |           |                          |  |
|                                   | None  | Not selected.   | 0                                 |           |           |                             |                |                       |           |                          |  |
|                                   | Commut signals                              | Commutation signals.  | 1                                 |           |           |                             |                |                       |           |                          |  |
|                                   | EnDat                                       | Serial interface: EnDat encoder.  | 2                                 |           |           |                             |                |                       |           |                          |  |
|                                   | Hiperface                                   | Serial interface: HIPERFACE encoder.  | 3                                 |           |           |                             |                |                       |           |                          |  |
|                                   | SSI   | Serial interface: SSI encoder.  | 4                                 |           |           |                             |                |                       |           |                          |  |
|                                   | Tamagawa                                    | Serial interface: Tamagawa 17/33-bit encoder.   | 5                                 |           |           |                             |                |                       |           |                          |  |
| 92.11                             | <a href="#">Excitation signal amplitude</a> | (Visible when a resolver is selected)<br>Defines the rms amplitude of the excitation signal.  | 4.0 V                             |           |           |                             |                |                       |           |                          |  |
|                                   | 4.0 ... 12.0 V                              | Excitation signal amplitude.  | 10 = 1 V                          |           |           |                             |                |                       |           |                          |  |
| 92.12                             | <a href="#">Speed calculation mode</a>      | (Visible when a TTL, TTL+ or HTL encoder is selected)<br>Selects the speed calculation mode.<br>*With a single-track encoder (parameter <a href="#">92.11 Pulse encoder type</a> is set to <a href="#">Single track</a> ), the speed is always positive.  | <a href="#">Auto rising</a>       |           |           |                             |                |                       |           |                          |  |
|                                   | A&B all                                     | Channels A and B: Rising and falling edges are used for speed calculation.<br>*Channel B: Defines the direction of rotation.<br><b>Note:</b> With a single-track encoder (parameter <a href="#">92.11 Pulse encoder type</a> ), this setting acts like setting <a href="#">A all</a> .  | 0                                 |           |           |                             |                |                       |           |                          |  |
|                                   | A all                                       | Channel A: Rising and falling edges are used for speed calculation.<br>*Channel B: Defines the direction of rotation.   | 1                                 |           |           |                             |                |                       |           |                          |  |
|                                   | A rising                                    | Channel A: Rising edges are used for speed calculation.<br>*Channel B: Defines the direction of rotation.   | 2                                 |           |           |                             |                |                       |           |                          |  |
|                                   | A falling                                   | Channel A: Falling edges are used for speed calculation.<br>*Channel B: Defines the direction of rotation.  | 3                                 |           |           |                             |                |                       |           |                          |  |
|                                   | Auto rising                                 | One of the above modes is selected automatically depending on the pulse frequency as follows:   | 4                                 |           |           |                             |                |                       |           |                          |  |
|                                   |   | <table border="1"> <thead> <tr> <th>Pulse frequency of the channel(s)</th> <th>Used mode</th> </tr> </thead> <tbody> <tr> <td>&lt; 2442 Hz</td> <td><a href="#">A&amp;B all</a></td> </tr> <tr> <td>2442...4884 Hz</td> <td><a href="#">A all</a></td> </tr> <tr> <td>&gt; 4884 Hz</td> <td><a href="#">A rising</a></td> </tr> </tbody> </table> | Pulse frequency of the channel(s) | Used mode | < 2442 Hz | <a href="#">A&amp;B all</a> | 2442...4884 Hz | <a href="#">A all</a> | > 4884 Hz | <a href="#">A rising</a> |  |
| Pulse frequency of the channel(s) | Used mode                                   |   |                                   |           |           |                             |                |                       |           |                          |  |
| < 2442 Hz                         | <a href="#">A&amp;B all</a>                 |   |                                   |           |           |                             |                |                       |           |                          |  |
| 2442...4884 Hz                    | <a href="#">A all</a>                       |   |                                   |           |           |                             |                |                       |           |                          |  |
| > 4884 Hz                         | <a href="#">A rising</a>                    |   |                                   |           |           |                             |                |                       |           |                          |  |



| No.                               | Name/Value                        | Description  | Def/FbEq16                        |           |           |                    |                |              |           |                  |   |
|-----------------------------------|-----------------------------------|--|-----------------------------------|-----------|-----------|--------------------|----------------|--------------|-----------|------------------|---|
|                                   | Auto falling                      | One of the above modes is selected automatically depending on the pulse frequency as follows:<br><table border="1" data-bbox="478 322 1188 504"> <thead> <tr> <th>Pulse frequency of the channel(s)</th> <th>Used mode</th> </tr> </thead> <tbody> <tr> <td>&lt; 2442 Hz</td> <td><i>A&amp;B all</i></td> </tr> <tr> <td>2442...4884 Hz</td> <td><i>A all</i></td> </tr> <tr> <td>&gt; 4884 Hz</td> <td><i>A falling</i></td> </tr> </tbody> </table>  | Pulse frequency of the channel(s) | Used mode | < 2442 Hz | <i>A&amp;B all</i> | 2442...4884 Hz | <i>A all</i> | > 4884 Hz | <i>A falling</i> | 5 |
| Pulse frequency of the channel(s) | Used mode                         |  |                                   |           |           |                    |                |              |           |                  |   |
| < 2442 Hz                         | <i>A&amp;B all</i>                |  |                                   |           |           |                    |                |              |           |                  |   |
| 2442...4884 Hz                    | <i>A all</i>                      |  |                                   |           |           |                    |                |              |           |                  |   |
| > 4884 Hz                         | <i>A falling</i>                  |  |                                   |           |           |                    |                |              |           |                  |   |
| 92.12                             | <i>Zero pulse enable</i>          | <i>(Visible when an absolute encoder is selected)</i><br>Enables the encoder zero pulse for the absolute encoder input (X42) of the FEN-11 interface module.<br><b>Note:</b> No zero pulse exists with serial interfaces, ie. when parameter <i>92.11 Absolute position source</i> is set to <i>EnDat</i> , <i>Hiperface</i> , <i>SSI</i> or <i>Tamagawa</i> .   | <i>Disable</i>                    |           |           |                    |                |              |           |                  |   |
|                                   | Disable                           | Zero pulse disabled.   | 0                                 |           |           |                    |                |              |           |                  |   |
|                                   | Enable                            | Zero pulse enabled.  | 1                                 |           |           |                    |                |              |           |                  |   |
| 92.12                             | <i>Resolver polepairs</i>         | <i>(Visible when a resolver is selected)</i><br>Defines the number of pole pairs of the resolver.  | 1                                 |           |           |                    |                |              |           |                  |   |
|                                   | 1...32                            | Number of resolver pole pairs.   | 1 = 1                             |           |           |                    |                |              |           |                  |   |
| 92.13                             | <i>Position estimation enable</i> | <i>(Visible when a TTL, TTL+ or HTL encoder is selected)</i><br>Selects whether position estimation is used with encoder 1 to increase position data resolution or not.  | <i>Enable</i>                     |           |           |                    |                |              |           |                  |   |
|                                   | Disable                           | Measured position used. (The resolution is 4 × pulses per revolution for quadrature encoders, 2 × pulses per revolution for single-track encoders.)  | 0                                 |           |           |                    |                |              |           |                  |   |
|                                   | Enable                            | Estimated position used. (Uses position interpolation; extrapolated at the time of data request.)  | 1                                 |           |           |                    |                |              |           |                  |   |
| 92.13                             | <i>Position data width</i>        | <i>(Visible when an absolute encoder is selected)</i><br>Defines the number of bits used to indicate position within one revolution. For example, a setting of 15 bits corresponds to 32768 positions per revolution.<br>The value is used when parameter <i>92.11 Absolute position source</i> is set to <i>EnDat</i> , <i>Hiperface</i> or <i>SSI</i> . When parameter <i>92.11 Absolute position source</i> is set to <i>Tamagawa</i> , this parameter is internally set to 17.<br><b>Note:</b> With an EnDat or HIPERFACE encoder and FEN-11 FPGA version VIE12200 or later, this parameter is automatically set upon validation of encoder settings ( <i>91.10 Encoder parameter refresh</i> ). | 0                                 |           |           |                    |                |              |           |                  |   |
|                                   | 0...32                            | Number of bits used in position indication within one revolution.  | 1 = 1                             |           |           |                    |                |              |           |                  |   |
| 92.14                             | <i>Speed estimation enable</i>    | <i>(Visible when a TTL, TTL+ or HTL encoder is selected)</i><br>Selects whether calculated or estimated speed is used.<br>Estimation increases the speed ripple in steady state operation, but improves the dynamics.<br><b>Note:</b> This parameter is not effective with FEN-xx modules with FPGA version VIEx 2000 or later.  | <i>Disable</i>                    |           |           |                    |                |              |           |                  |   |
|                                   | Disable                           | Last calculated speed used. (The calculation interval is 62.5 microseconds to 4 milliseconds.)   | 0                                 |           |           |                    |                |              |           |                  |   |
|                                   | Enable                            | Estimated speed (estimated at the time of data request) is used.   | 1                                 |           |           |                    |                |              |           |                  |   |



| No.   | Name/Value                              | Description   | Def/FbEq16 |
|-------|---|---|------------|
| 92.14 | <i>Revolution data width</i>            | (Visible when an absolute encoder is selected)<br>Defines the number of bits used in revolution counting with a multiturn encoder. For example, a setting of 12 bits would support counting up to 4096 revolutions.<br>The value is used when parameter <a href="#">92.11 Absolute position source</a> is set to <i>EnDat</i> , <i>Hiperface</i> or <i>SSI</i> . When parameter <a href="#">92.11 Absolute position source</a> is set to <i>Tamagawa</i> , setting this parameter to a non-zero value activates multiturn data requesting.<br><b>Note:</b> With an EnDat or HIPERFACE encoder and FEN-11 FPGA version VIE12200 or later, this parameter is automatically set upon validation of encoder settings ( <a href="#">91.10 Encoder parameter refresh</a> ). | 0          |
|       | 0...32                                  | Number of bits used in revolution count.  | 1 = 1      |
| 92.15 | <i>Transient filter</i>                 | (Visible when a TTL, TTL+ or HTL encoder is selected)<br>Activates transient filtering for the encoder (changes in direction of rotation are ignored above the selected pulse frequency).   | 4880 Hz    |
|       | 4880 Hz                                 | Change in direction of rotation allowed below 4880 Hz.  | 0          |
|       | 2440 Hz                                 | Change in direction of rotation allowed below 2440 Hz.  | 1          |
|       | 1220 Hz                                 | Change in direction of rotation allowed below 1220 Hz.  | 2          |
|       | Disabled                                | Change in direction of rotation allowed at any pulse frequency.   | 3          |
| 92.16 | <i>Encoder 1 supply voltage</i>         | (Visible when parameter <a href="#">92.01 Encoder 1 type</a> = <i>HTL 1</i> or <i>HTL 2</i> )<br>Selects the power supply voltage for encoder 1.  | 0V         |
|       | 0V                                      | Disabled.   | 0          |
|       | 5V                                      | 5 V.  | 1          |
|       | 24V                                     | 24 V.   | 2          |
| 92.17 | <i>Accepted pulse freq of encoder 1</i> | (Visible when parameter <a href="#">92.01 Encoder 1 type</a> = <i>HTL 1</i> or <i>HTL 2</i> )<br>Defines the maximum pulse frequency of encoder 1.  | 0 kHz      |
|       | 0...300 kHz                             | Pulse frequency.  | 1 = 1 kHz  |
| 92.21 | <i>Encoder cable fault mode</i>         | (Visible when a TTL, TTL+ or HTL encoder is selected)<br>Selects which encoder cable channels and wires are monitored for wiring faults.  | A, B       |
|       | A, B                                    | A and B.  | 0          |
|       | A, B, Z                                 | A, B and Z.   | 1          |
|       | A+, A-, B+, B-                          | A+, A-, B+ and B-.  | 2          |
|       | A+, A-, B+, B-, Z+, Z-                  | A+, A-, B+, B-, Z+ and Z-.  | 3          |

| No.   | Name/Value                          | Description  | Def/FbEq16       |
|-------|-------------------------------------|--|------------------|
| 92.23 | <i>Maximum pulse waiting time</i>   | (Visible when parameter 92.01 Encoder 1 type = TTL or HTL)<br>Determines a pulse waiting time used in speed calculation for the encoder interface. If no pulse edges are detected within this time, the measured speed is zeroed by the interface. Increasing the setting can improve measuring performance especially at low, near zero speeds.<br><b>Notes:</b> <ul style="list-style-type: none"> <li>The parameter is only supported by FEN-xx modules with FPGA version VIEx 2000 or later. On older modules, the pulse waiting time is fixed to 4 ms.</li> <li>The parameter only affects speed measurement. Position is updated whenever a new pulse edge is detected. When the measured speed from the interface is zero, the drive updates its speed data based on position changes.</li> </ul> | 4 ms             |
|       | 1...200 ms                          | Maximum pulse waiting time.  | 1 = 1 ms         |
| 92.24 | <i>Pulse edge filtering</i>         | (Visible when parameter 92.01 Encoder 1 type = HTL)<br>Enables pulse edge filtering. Pulse edge filtering can improve the reliability of measurements especially from encoders with a single-ended connection.<br><b>Notes:</b> <ul style="list-style-type: none"> <li>Pulse edge filtering is only supported by FEN-31 modules with FPGA version VIE3 2200 or later.</li> <li>Pulse edge filtering decreases the maximum pulse frequency. With 2 µs filtering time, the maximum pulse frequency is 200 kHz.</li> </ul>  | No filtering     |
|       | No filtering                        | Filtering disabled.  | 0                |
|       | 1 µs                                | Filtering time: 1 microsecond.   | 1                |
|       | 2 µs                                | Filtering time: 2 microseconds.  | 2                |
| 92.25 | <i>Pulse overfrequency function</i> | (Visible when parameter 92.01 Encoder 1 type = HTL)<br>Selects how the drive reacts when the encoder interface detects a pulse overfrequency condition.<br><b>Note:</b> This parameter is effective only with FEN-xx module FPGA version VIEx 2200 or later.   | Fault            |
|       | Warning                             | The drive generates a warning, <i>7381 Encoder</i> . The FEN-xx module will continue to update speed and position data.  | 0                |
|       | Fault                               | The drive trips on fault <i>A7E1 Encoder</i> .   | 1                |
| 92.30 | <i>Serial link mode</i>             | (Visible when an absolute encoder is selected)<br>Selects the serial link mode with an EnDat or SSI encoder.   | Initial position |
|       | Initial position                    | Single position transfer mode (initial position).  | 0                |
|       | Continuous                          | Continuous position data transfer mode.  | 1                |
|       | Continuous speed and position       | Continuous speed and position data transfer mode. This setting is intended for EnDat 2.2 encoders without sin/cos signals.<br><b>Note:</b> This setting requires an FEN-11 interface revision H or later.  | 2                |

| No.   | Name/Value                        | Description  | Def/FbEq16        |
|-------|-----------------------------------|--|-------------------|
| 92.31 | <i>EnDat max calculation time</i> | <i>(Visible when an absolute encoder is selected)</i><br>Selects the maximum encoder calculation time for an EnDat encoder.<br><b>Note:</b> This parameter needs to be set only when an EnDat encoder is used in continuous mode, ie. without incremental sin/cos signals (supported only as encoder 1). See also parameter <a href="#">92.30 Serial link mode</a> . | <i>50 ms</i>      |
|       | 10 us                             | 10 microseconds.   | 0                 |
|       | 100 us                            | 100 microseconds.  | 1                 |
|       | 1 ms                              | 1 millisecond.   | 2                 |
|       | 50 ms                             | 50 milliseconds.   | 3                 |
| 92.32 | <i>SSI cycle time</i>             | <i>(Visible when an absolute encoder is selected)</i><br>Selects the transmission cycle for an SSI encoder.<br><b>Note:</b> This parameter needs to be set only when an SSI encoder is used in continuous mode, ie. without incremental sin/cos signals (supported only as encoder 1). See also parameter <a href="#">92.30 Serial link mode</a> .                   | <i>100 us</i>     |
|       | 50 us                             | 50 microseconds.   | 0                 |
|       | 100 us                            | 100 microseconds.  | 1                 |
|       | 200 us                            | 200 microseconds.  | 2                 |
|       | 500 us                            | 500 microseconds.  | 3                 |
|       | 1 ms                              | 1 millisecond.   | 4                 |
|       | 2 ms                              | 2 milliseconds.  | 5                 |
| 92.33 | <i>SSI clock cycles</i>           | <i>(Visible when an absolute encoder is selected)</i><br>Defines the length of an SSI message. The length is defined as the number of clock cycles. The number of cycles can be calculated by adding 1 to the number of bits in an SSI message frame.  | 2                 |
|       | 2...127                           | SSI message length.  | -                 |
| 92.34 | <i>SSI position msb</i>           | <i>(Visible when an absolute encoder is selected)</i><br>With an SSI encoder, defines the location of the MSB (most significant bit) of the position data within an SSI message.   | 1                 |
|       | 1...126                           | Position data MSB location (bit number).   | -                 |
| 92.35 | <i>SSI revolution msb</i>         | <i>(Visible when an absolute encoder is selected)</i><br>With an SSI encoder, defines the location of the MSB (most significant bit) of the revolution count within an SSI message.  | 1                 |
|       | 1...126                           | Revolution count MSB location (bit number).  | -                 |
| 92.36 | <i>SSI data format</i>            | <i>(Visible when an absolute encoder is selected)</i><br>Selects the data format for an SSI encoder.   | <i>Binary</i>     |
|       | Binary                            | Binary code.   | 0                 |
|       | Gray                              | Gray code.   | 1                 |
| 92.37 | <i>SSI baud rate</i>              | <i>(Visible when an absolute encoder is selected)</i><br>Selects the baud rate for an SSI encoder.   | <i>100 kBit/s</i> |
|       | 10 kBit/s                         | 10 kbit/s.   | 0                 |
|       | 50 kBit/s                         | 50 kbit/s.   | 1                 |
|       | 100 kBit/s                        | 100 kbit/s.  | 2                 |
|       | 200 kBit/s                        | 200 kbit/s.  | 3                 |

| No.  | Name/Value                             | Description  | Def/FbEq16                      |
|--|--|--|---------------------------------|
|  | 500 kBit/s                             | 500 kbit/s.  | 4                               |
|  | 1000 kBit/s                            | 1000 kbit/s.   | 5                               |
| <a href="#">92.40</a>                      | <a href="#">SSI zero phase</a>         | <i>(Visible when an absolute encoder is selected)</i><br>Defines the phase angle within one sine/cosine signal period that corresponds to the value of zero on the SSI serial link data. The parameter is used to adjust the synchronization of the SSI position data and the position based on sine/cosine incremental signals. Incorrect synchronization may cause an error of $\pm 1$ incremental period.<br><b>Note:</b> This parameter needs to be set only when an SSI encoder is used in initial position mode (see parameter <a href="#">92.30 Serial link mode</a> ). | <a href="#">315-45 deg</a>      |
|  | 315-45 deg                             | 315-45 degrees.  | 0                               |
|  | 45-135 deg                             | 45-135 degrees.  | 1                               |
|  | 135-225 deg                            | 135-225 degrees.   | 2                               |
|  | 225-315 deg                            | 225-315 degrees.   | 3                               |
| <a href="#">92.45</a>                      | <a href="#">Hiperface parity</a>       | <i>(Visible when an absolute encoder is selected)</i><br>Defines the use of parity and stop bits with a HIPERFACE encoder.<br>Typically this parameter need not be set.  | <a href="#">Odd</a>             |
|  | Odd                                    | Odd parity indication bit, one stop bit.   | 0                               |
|  | Even                                   | Even parity indication bit, one stop bit.  | 1                               |
| <a href="#">92.46</a>                      | <a href="#">Hiperface baud rate</a>    | <i>(Visible when an absolute encoder is selected)</i><br>Defines the transfer rate of the link with a HIPERFACE encoder.<br>Typically this parameter need not be set.  | <a href="#">4800 bits/s</a>     |
|  | 4800 bits/s                            | 4800 bit/s.  | 0                               |
|  | 9600 bits/s                            | 9600 bit/s.  | 1                               |
|  | 19200 bits/s                           | 19200 bit/s.   | 2                               |
|  | 38400 bits/s                           | 38400 bit/s.   | 3                               |
| <a href="#">92.47</a>                      | <a href="#">Hiperface node address</a> | <i>(Visible when an absolute encoder is selected)</i><br>Defines the node address for a HIPERFACE encoder.<br>Typically this parameter need not be set.  | 64                              |
|  | 0...255                                | HIPERFACE encoder node address.  | -                               |
| <a href="#">93 Encoder 2 configuration</a> |  | Settings for encoder 2.<br><b>Notes:</b> <ul style="list-style-type: none"> <li>The contents of the parameter group vary according to the selected encoder type.</li> <li>It is recommended that encoder connection 1 (group <a href="#">92 Encoder 1 configuration</a>) is used whenever possible since the data received through that interface is fresher than the data received through connection 2 (this group).</li> </ul>  |                                 |
| <a href="#">93.01</a>                      | <a href="#">Encoder 2 type</a>         | Selects the type of encoder/resolver 2.  | <a href="#">None configured</a> |
|  | None configured                        | None.  | 0                               |
|  | TTL                                    | TTL. Module type (input): FEN-01 (X31), FEN-11 (X41) or FEN-21 (X51).  | 1                               |
|  | TTL+                                   | TTL+. Module type (input): FEN-01 (X32).   | 2                               |

| No.   | Name/Value                              | Description  | Def/FbEq16                  |
|-------|---|--|-----------------------------|
|       | Absolute encoder                        | Absolute encoder. Module type (input): FEN-11 (X42).   | 3                           |
|       | Resolver                                | Resolver. Module type (input): FEN-21 (X52).   | 4                           |
|       | HTL                                     | HTL. Module type (input): FEN-31 (X82).  | 5                           |
|       | HTL 1                                   | HTL. Module type (input): FSE-31 (X31).  | 6                           |
|       | HTL 2                                   | HTL. Module type (input): FSE-31 (X32). Not supported at the time of publication.  | 7                           |
| 93.02 | <i>Encoder 2 source</i>                 | Selects the interface module that the encoder is connected to. (The physical locations and types of encoder interface modules are defined in parameter group <a href="#">91 Encoder module settings</a> .) | <a href="#">Module 1</a>    |
|       | Module 1                                | Interface module 1.  | 1                           |
|       | Module 2                                | Interface module 2.  | 2                           |
| 93.10 | <i>Pulses/rev</i>                       | (Visible when a TTL, TTL+ or HTL encoder is selected)<br>See parameter <a href="#">92.10 Pulses/revolution</a> .   | 2048                        |
| 93.10 | <i>Sine/cosine number</i>               | (Visible when an absolute encoder is selected)<br>See parameter <a href="#">92.10 Sine/cosine number</a> .   | 0                           |
| 93.10 | <i>Excitation signal frequency</i>      | (Visible when a resolver is selected)<br>See parameter <a href="#">92.10 Excitation signal frequency</a> .   | 1 kHz                       |
| 93.11 | <i>Pulse encoder type</i>               | (Visible when a TTL, TTL+ or HTL encoder is selected)<br>See parameter <a href="#">92.11 Pulse encoder type</a> .  | <a href="#">Quadrature</a>  |
| 93.11 | <i>Absolute position source</i>         | (Visible when an absolute encoder is selected)<br>See parameter <a href="#">92.11 Absolute position source</a> .   | <a href="#">None</a>        |
| 93.11 | <i>Excitation signal amplitude</i>      | (Visible when a resolver is selected)<br>See parameter <a href="#">92.11 Excitation signal amplitude</a> .   | 4.0 V                       |
| 93.12 | <i>Speed calculation mode</i>           | (Visible when a TTL, TTL+ or HTL encoder is selected)<br>See parameter <a href="#">92.12 Speed calculation mode</a> .  | <a href="#">Auto rising</a> |
| 93.12 | <i>Zero pulse enable</i>                | (Visible when an absolute encoder is selected)<br>See parameter <a href="#">92.12 Zero pulse enable</a> .  | <a href="#">Disable</a>     |
| 93.12 | <i>Resolver polepairs</i>               | (Visible when a resolver is selected)<br>See parameter <a href="#">92.12 Resolver polepairs</a> .  | 1                           |
| 93.13 | <i>Position estimation enable</i>       | (Visible when a TTL, TTL+ or HTL encoder is selected)<br>See parameter <a href="#">92.13 Position estimation enable</a> .  | <a href="#">Enable</a>      |
| 93.13 | <i>Position data width</i>              | (Visible when an absolute encoder is selected)<br>See parameter <a href="#">92.13 Position data width</a> .  | 0                           |
| 93.14 | <i>Speed estimation enable</i>          | (Visible when a TTL, TTL+ or HTL encoder is selected)<br>See parameter <a href="#">92.14 Speed estimation enable</a> .   | <a href="#">Disable</a>     |
| 93.14 | <i>Revolution data width</i>            | (Visible when an absolute encoder is selected)<br>See parameter <a href="#">92.14 Revolution data width</a> .  | 0                           |
| 93.15 | <i>Transient filter</i>                 | (Visible when a TTL, TTL+ or HTL encoder is selected)<br>See parameter <a href="#">92.15 Transient filter</a> .  | <a href="#">4880 Hz</a>     |
| 93.16 | <i>Encoder 2 supply voltage</i>         | (Visible when parameter <a href="#">93.01 Encoder 2 type</a> = HTL 1 or HTL 2)<br>See parameter <a href="#">92.16 Encoder 1 supply voltage</a> .   | <a href="#">0V</a>          |
| 93.17 | <i>Accepted pulse freq of encoder 2</i> | (Visible when parameter <a href="#">93.01 Encoder 2 type</a> = HTL 1 or HTL 2)<br>See parameter <a href="#">92.17 Accepted pulse freq of encoder 1</a> .   | 0 kHz                       |

| No.                   | Name/Value                          | Description  | Def/FbEq16       |
|-----------------------|-------------------------------------|--|------------------|
| 93.21                 | <i>Encoder cable fault mode</i>     | (Visible when a TTL, TTL+ or HTL encoder is selected)<br>See parameter <a href="#">92.21 Encoder cable fault mode</a> .  | A, B             |
| 93.23                 | <i>Maximum pulse waiting time</i>   | (Visible when parameter <a href="#">93.01 Encoder 2 type = TTL or HTL</a> )<br>See parameter <a href="#">92.23 Maximum pulse waiting time</a> .  | 4 ms             |
| 93.24                 | <i>Pulse edge filtering</i>         | (Visible when parameter <a href="#">93.01 Encoder 2 type = HTL</a> )<br>See parameter <a href="#">92.24 Pulse edge filtering</a> .   | No filtering     |
| 93.25                 | <i>Pulse overfrequency function</i> | (Visible when parameter <a href="#">93.01 Encoder 2 type = HTL</a> )<br>See parameter <a href="#">92.25 Pulse overfrequency function</a> .   | Fault            |
| 93.30                 | <i>Serial link mode</i>             | (Visible when an absolute encoder is selected)<br>See parameter <a href="#">92.30 Serial link mode</a> .   | Initial position |
| 93.31                 | <i>EnDat calc time</i>              | (Visible when an absolute encoder is selected)<br>See parameter <a href="#">92.31 EnDat max calculation time</a> .   | 50 ms            |
| 93.32                 | <i>SSI cycle time</i>               | (Visible when an absolute encoder is selected)<br>See parameter <a href="#">92.32 SSI cycle time</a> .   | 100 us           |
| 93.33                 | <i>SSI clock cycles</i>             | (Visible when an absolute encoder is selected)<br>See parameter <a href="#">92.33 SSI clock cycles</a> .   | 2                |
| 93.34                 | <i>SSI position msb</i>             | (Visible when an absolute encoder is selected)<br>See parameter <a href="#">92.34 SSI position msb</a> .   | 1                |
| 93.35                 | <i>SSI revolution msb</i>           | (Visible when an absolute encoder is selected)<br>See parameter <a href="#">92.35 SSI revolution msb</a> .   | 1                |
| 93.36                 | <i>SSI data format</i>              | (Visible when an absolute encoder is selected)<br>See parameter <a href="#">92.36 SSI data format</a> .  | Binary           |
| 93.37                 | <i>SSI baud rate</i>                | (Visible when an absolute encoder is selected)<br>See parameter <a href="#">92.37 SSI baud rate</a> .  | 100 kBit/s       |
| 93.40                 | <i>SSI zero phase</i>               | (Visible when an absolute encoder is selected)<br>See parameter <a href="#">92.40 SSI zero phase</a> .   | 315-45 deg       |
| 93.45                 | <i>Hiperface parity</i>             | (Visible when an absolute encoder is selected)<br>See parameter <a href="#">92.45 Hiperface parity</a> .   | Odd              |
| 93.46                 | <i>Hiperface baud rate</i>          | (Visible when an absolute encoder is selected)<br>See parameter <a href="#">92.46 Hiperface baud rate</a> .  | 4800 bits/s      |
| 93.47                 | <i>Hiperface node address</i>       | (Visible when an absolute encoder is selected)<br>See parameter <a href="#">92.47 Hiperface node address</a> .   | 64               |
| <b>94 LSU control</b> |                                     | Control of the supply unit of the drive, such as DC voltage and reactive power reference.<br>Note that the references defined here must also be selected as the reference source in the supply control program to be effective.<br>This group is only visible when supply unit control has been activated by parameter <a href="#">95.20 HW options word 1</a> .<br>See also section <a href="#">Control of a supply unit (LSU)</a> (page 40). |                  |
| 94.01                 | <i>LSU control</i>                  | Enables/disables the internal INU-LSU state machine.<br>When the state machine is enabled, the inverter unit (INU) controls the supply unit (LSU) and prevents the inverter unit from starting until the supply unit is ready.<br>When the state machine is disabled, the status of the supply unit (LSU) is ignored by the inverter unit.   | On               |
|                       | Off                                 | INU-LSU state machine disabled.  | 0                |
|                       | On                                  | INU-LSU state machine enabled.   | 1                |

| No.   | Name/Value                                | Description  | Def/FbEq16               |
|-------|---|--|--------------------------|
| 94.02 | <a href="#">LSU panel communication</a>   | Enables/disables control panel and PC tool access to the supply unit (line-side converter) via the inverter unit (motor-side converter).<br><b>Note:</b> This feature is only supported by the following drives: <ul style="list-style-type: none"> <li>• ACS880-11</li> <li>• ACS880-31</li> <li>• ACS880-17 based on an integrated drive module</li> <li>• ACS880-37 based on an integrated drive module.</li> </ul> | <a href="#">Disable</a>  |
|       | Disable                                   | Control panel and PC tool access to supply unit via inverter unit disabled.  | 0                        |
|       | Enable                                    | Control panel and PC tool access to supply unit via inverter unit enabled.   | 1                        |
| 94.10 | <a href="#">LSU max charging time</a>     | Defines the maximum time the supply unit (LSU) is allowed for charging before a fault ( <a href="#">7584 LSU charge failed</a> ) is generated.   | 15 s                     |
|       | 0...65535 s                               | Maximum charging time.   | 1 = 1 s                  |
| 94.11 | <a href="#">LSU stop delay</a>            | Defines a stop delay for the supply unit. This parameter can be used to delay the opening of the main breaker/contactors when a restart is expected.   | 600.0 s                  |
|       | 0.0 ... 3600.0 s                          | Supply unit stop delay.  | 10 = 1 s                 |
| 94.20 | <a href="#">DC voltage reference</a>      | ( <i>Only visible when IGBT supply unit control activated by <a href="#">95.20</a></i> )<br>Displays the DC voltage reference sent to the supply unit. This parameter is read-only.  | -                        |
|       | 0.0 ... 2000.0 V                          | DC voltage reference sent to supply unit.  | 10 = 1 V                 |
| 94.21 | <a href="#">DC voltage ref source</a>     | ( <i>Only visible when IGBT supply unit control activated by <a href="#">95.20</a></i> )<br>Selects the source of the DC voltage reference to be sent to the supply unit.  | <a href="#">User ref</a> |
|       | Zero                                      | None.  | 0                        |
|       | User ref                                  | <a href="#">94.22 User DC voltage reference</a> .  | 1                        |
|       | <a href="#">Other</a>                     | Source selection (see <a href="#">Terms and abbreviations</a> on page 112).  | -                        |
| 94.22 | <a href="#">User DC voltage reference</a> | ( <i>Only visible when IGBT supply unit control activated by <a href="#">95.20</a></i> )<br>Defines the DC voltage reference for the supply unit when <a href="#">94.21 DC voltage ref source</a> is set to <a href="#">User ref</a> .   | 0.0 V                    |
|       | 0.0 ... 2000.0 V                          | User DC reference.   | 10 = 1 V                 |
| 94.30 | <a href="#">Reactive power reference</a>  | ( <i>Only visible when IGBT supply unit control activated by <a href="#">95.20</a></i> )<br>Displays the reactive power reference sent to the supply unit. This parameter is read-only.  | -                        |
|       | -3276.8 ... 3276.7 kvar                   | Reactive power reference sent to the supply unit.  | 10 = 1 kvar              |
| 94.31 | <a href="#">Reactive power ref source</a> | ( <i>Only visible when IGBT supply unit control activated by <a href="#">95.20</a></i> )<br>Selects the source of the reactive power reference to be sent to the supply unit.  | <a href="#">User ref</a> |
|       | Zero                                      | None.  | 0                        |
|       | User ref                                  | <a href="#">94.32 User reactive power reference</a> .  | 1                        |
|       | <a href="#">Other</a>                     | Source selection (see <a href="#">Terms and abbreviations</a> on page 112).  | -                        |



## 400 Parameters

| No.                        | Name/Value                           | Description   | Def/FbEq16  |
|----------------------------|--------------------------------------|---|-------------|
| 94.32                      | <i>User reactive power reference</i> | (Only visible when IGBT supply unit control activated by 95.20)<br>Defines the reactive power reference for the supply unit when 94.31 <i>Reactive power ref source</i> is set to <i>User ref</i> .   | 0.0 kvar    |
|                            | -3276.8 ... 3276.7 kvar              | User reactive power reference.  | 10 = 1 kvar |
| 94.40                      | <i>Power mot limit on net loss</i>   | Defines the maximum shaft power for motoring mode upon a supply network failure when IGBT supply unit control is active (bit 15 of 95.20 <i>HW options word 1</i> is on).<br>The value is given in percent of nominal motor power.<br><b>Note:</b> With a diode supply unit (bit 11 of 95.20 is on), the motoring shaft power is limited to 2% upon a network failure regardless of this parameter.   | 600.00%     |
|                            | 0.00 ... 600.00%                     | Maximum shaft power for motoring mode upon a supply network failure.  | 1 = 1%      |
| 94.41                      | <i>Power gen limit on net loss</i>   | Defines the maximum shaft power for generating upon a supply network failure when supply unit control is active (bit 11 or 15 of 95.20 <i>HW options word 1</i> is on).<br>The value is given in percent of nominal motor power.  | -600.00%    |
|                            | -600.00 ... 0.00%                    | Maximum shaft power for generating mode upon a supply network failure.  | 1 = 1%      |
| <b>95 HW configuration</b> |                                      | Various hardware-related settings.  |             |
| 95.01                      | <i>Supply voltage</i>                | Selects the supply voltage range. This parameter is used by the drive to determine the nominal voltage of the supply network. The parameter also affects the current ratings and the DC voltage control functions (trip and brake chopper activation limits) of the drive.<br> <b>WARNING!</b> An incorrect setting may cause the motor to rush uncontrollably, or the brake chopper or resistor to overload.<br><b>Note:</b> The selections shown depend on the hardware of the drive. If only one voltage range is valid for the drive in question, it is selected by default. | -           |
|                            | Not given                            | No voltage range selected. The drive will not start modulating before a range is selected.  | 0           |
|                            | 208...240 V                          | 208...240 V   | 1           |
|                            | 380...415 V                          | 380...415 V   | 2           |
|                            | 440...480 V                          | 440...480 V   | 3           |
|                            | 500 V                                | 500 V   | 4           |
|                            | 525...600 V                          | 525...600 V   | 5           |
|                            | 660...690 V                          | 660...690 V   | 6           |

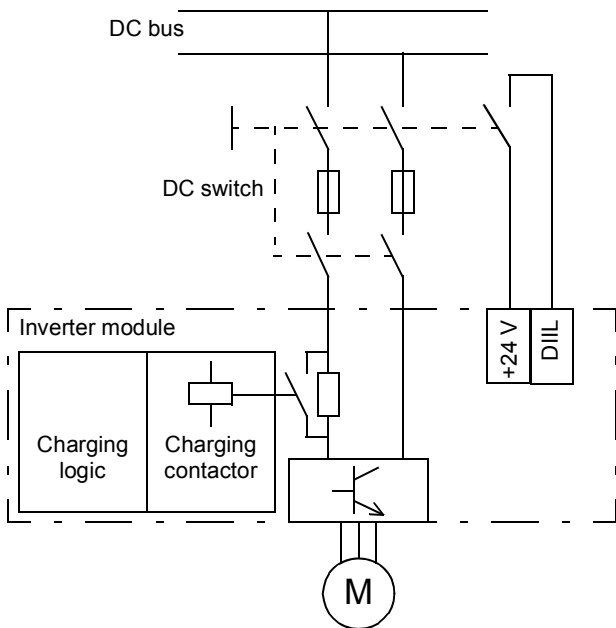

| No.   | Name/Value                     | Description   | Def/FbEq16  |
|-------|--------------------------------|---|---|
| 95.02 | <i>Adaptive voltage limits</i> | <p>Enables adaptive voltage limits.</p> <p>Adaptive voltage limits can be used if, for example, an IGBT supply unit is used to raise the DC voltage level. If the communication between the inverter and the IGBT supply unit is active (<i>95.20 HW options word 1</i>), the voltage limits are related to the DC voltage reference transmitted to the supply unit (<i>94.20 DC voltage reference</i>) assuming that the reference is high enough. Otherwise, the limits are calculated based on the measured DC voltage at the end of the pre-charging sequence.</p> <p>This function is also useful if the AC supply voltage to the drive is high, as the warning levels are raised accordingly.</p> | <i>Disable</i>  |
|       | Disable                        | Adaptive voltage limits disabled.   | 0   |
|       | Enable                         | Adaptive voltage limits enabled.  | 1   |
| 95.04 | <i>Control board supply</i>    | <p>Specifies how the control unit of the drive is powered. The default value depends on the type of the control unit and the setting of parameter <i>95.20</i>.</p>   | <i>Internal 24V</i> (ZCU);<br><i>External 24V</i> (BCU; <i>95.20 b4</i> ) |
|       | Internal 24V                   | <p>The drive control unit is powered from the drive power unit it is connected to.</p> <p><b>Note:</b> If reduced run (see page <i>92</i>) is required, select <i>External 24V</i> or <i>Redundant external 24V</i> instead.</p>  | 0   |
|       | External 24V                   | <p>The drive control unit is powered from an external power supply. The drive power unit and power unit link faults are masked when the drive is in stopped state, so the main circuit can be powered down without faults while the control unit is powered.</p>  | 1   |
|       | Redundant external 24V         | <p>(Type BCU control units only) The drive control unit is powered from two redundant external power supplies. The loss of one of the supplies generates a warning (<i>AFEC External power signal missing</i>). The drive power unit and power unit link faults are masked when the drive is in stopped state, so the main circuit can be powered down without faults while the control unit is powered.</p>  | 2   |

| No.   | Name/Value                    | Description   | Def/FbEq16                        |
|-------|-------------------------------|---|-----------------------------------|
| 95.08 | <i>DC switch monitoring</i>   | <p>(Only visible with a ZCU control unit)</p> <p>Enables/disables DC switch monitoring via the DIIL input. This setting is intended for use with inverter modules with an internal charging circuit that are connected to the DC bus through a DC switch.</p> <p>An auxiliary contact of the DC switch must be wired to the DIIL input so that the input switches off when the DC switch is opened.</p>  <p>If the DC switch is opened with the inverter running, the inverter is given a coast-to-stop command, and its charging circuit activated.</p> <p>Starting the inverter is prevented until the DC switch is closed and the DC circuit in the inverter unit recharged.</p> <p><b>Notes:</b></p> <ul style="list-style-type: none"> <li>• By default, DIIL is the input for the Run enable signal. Adjust <a href="#">20.12 Run enable 1 source</a> if necessary.</li> <li>• An internal charging circuit is standard on some inverter module types but optional on others; check with your local ABB representative.</li> </ul> | <i>Disable; Enable (95.20 b5)</i> |
|       | Disable                       | DC switch monitoring through the DIIL input disabled.   | 0                                 |
|       | Enable                        | DC switch monitoring through the DIIL input enabled.  | 1                                 |
| 95.09 | <i>Switch fuse controller</i> | <p>(Only visible with a BCU control unit)</p> <p>Activates communication to a xSFC charging controller. This setting is intended for use with inverter modules that are connected to a DC bus through a DC switch/charging circuit controlled by a charging controller. On units without a DC switch, this parameter should be set to <i>Disable</i>.</p> <p>The charging controller monitors the charging of the inverter unit, and sends an enable command when the charging has finished (ie. DC switch is closed after the 'charging OK' lamp lights, and charging switch opened).</p> <p>For more information, see xSFC documentation.</p>   | <i>Enable</i>                     |
|       | Disable                       | Communication with xSFC disabled.   | 0                                 |
|       | Enable                        | Communication with xSFC enabled.  | 1                                 |

| No.     | Name/Value                 | Description   | Def/FbEq16 |      |             |   |          |   |   |                 |  |     |                 |   |    |                    |  |         |          |  |  |
|---------|----------------------------|---|------------|------|-------------|---|----------|---|---|-----------------|--|-----|-----------------|---|----|--------------------|--|---------|----------|--|--|
| 95.13   | <i>Reduced run mode</i>    | <i>(Only visible with a BCU control unit)</i><br>Specifies the number of inverter modules available.<br>This parameter must be set if reduced run is required. A value other than 0 activates the reduced run function.<br>If the control program cannot detect the number of modules specified by this parameter, a fault ( <a href="#">5695 Reduced run</a> ) is generated.<br>See section <a href="#">Reduced run function</a> (page 92).<br>0 = Reduced run disabled<br>1...12 = Number of modules available  | 0          |      |             |   |          |   |   |                 |  |     |                 |   |    |                    |  |         |          |  |  |
|         | 0...65535                  | Number of inverter modules available  | -          |      |             |   |          |   |   |                 |  |     |                 |   |    |                    |  |         |          |  |  |
| 95.14   | <i>Connected modules</i>   | <i>(Only visible with a BCU control unit)</i><br>Shows which of the parallel-connected inverter modules have been detected by the control program.  | -          |      |             |   |          |   |   |                 |  |     |                 |   |    |                    |  |         |          |  |  |
|         |                            | <table border="1"> <thead> <tr> <th>Bit</th> <th>Name</th> <th>Description</th> </tr> </thead> <tbody> <tr> <td>0</td> <td>Module 1</td> <td>1 = Module 1 has been detected.</td> </tr> <tr> <td>1</td> <td>Module 2</td> <td>1 = Module 2 has been detected.</td> </tr> <tr> <td>...</td> <td>...</td> <td>...</td> </tr> <tr> <td>11</td> <td>Module 12</td> <td>1 = Module 12 has been detected.</td> </tr> <tr> <td>12...15</td> <td>Reserved</td> <td></td> </tr> </tbody> </table>  | Bit        | Name | Description | 0 | Module 1 | 1 = Module 1 has been detected.   | 1 | Module 2        | 1 = Module 2 has been detected.  | ... | ...             | ...   | 11 | Module 12          | 1 = Module 12 has been detected.   | 12...15 | Reserved |  |  |
| Bit     | Name                       | Description   |            |      |             |   |          |   |   |                 |  |     |                 |   |    |                    |  |         |          |  |  |
| 0       | Module 1                   | 1 = Module 1 has been detected.   |            |      |             |   |          |   |   |                 |  |     |                 |   |    |                    |  |         |          |  |  |
| 1       | Module 2                   | 1 = Module 2 has been detected.   |            |      |             |   |          |   |   |                 |  |     |                 |   |    |                    |  |         |          |  |  |
| ...     | ...                        | ...   |            |      |             |   |          |   |   |                 |  |     |                 |   |    |                    |  |         |          |  |  |
| 11      | Module 12                  | 1 = Module 12 has been detected.  |            |      |             |   |          |   |   |                 |  |     |                 |   |    |                    |  |         |          |  |  |
| 12...15 | Reserved                   |   |            |      |             |   |          |   |   |                 |  |     |                 |   |    |                    |  |         |          |  |  |
|         | 0000h...FFFFh              | Inverter modules connected.   | 1 = 1      |      |             |   |          |   |   |                 |  |     |                 |   |    |                    |  |         |          |  |  |
| 95.15   | <i>Special HW settings</i> | Contains hardware-related settings that can be enabled and disabled by toggling the specific bits.<br><b>Note:</b> The installation of the hardware specified by this parameter may require derating of drive output, or impose other limitations. Refer to the hardware manual of the drive.   | -          |      |             |   |          |   |   |                 |  |     |                 |   |    |                    |  |         |          |  |  |
|         |                            | <table border="1"> <thead> <tr> <th>Bit</th> <th>Name</th> <th>Information</th> </tr> </thead> <tbody> <tr> <td>0</td> <td>EX motor</td> <td>1 = The driven motor is an Ex motor provided by ABB for potentially explosive atmospheres. This sets the required minimum switching frequency for ABB Ex motors. <b>Note:</b> For non-ABB Ex motors, contact your local ABB representative.</td> </tr> <tr> <td>1</td> <td>ABB sine filter</td> <td>1 = An ABB sine filter is connected to the output of the drive/inverter.</td> </tr> <tr> <td>2</td> <td>High speed mode</td> <td>1 = Minimum switching frequency limit adaptation to output frequency active. This setting improves control performance at high output frequencies (typically above 120 Hz).</td> </tr> <tr> <td>3</td> <td>Custom sine filter</td> <td>1 = A custom sine filter is connected to the output of the drive/inverter. See also parameters <a href="#">97.01</a>, <a href="#">97.02</a>, <a href="#">99.18</a>, <a href="#">99.19</a>.</td> </tr> <tr> <td>4...15</td> <td>Reserved</td> <td></td> </tr> </tbody> </table> | Bit        | Name | Information | 0 | EX motor | 1 = The driven motor is an Ex motor provided by ABB for potentially explosive atmospheres. This sets the required minimum switching frequency for ABB Ex motors. <b>Note:</b> For non-ABB Ex motors, contact your local ABB representative. | 1 | ABB sine filter | 1 = An ABB sine filter is connected to the output of the drive/inverter. | 2   | High speed mode | 1 = Minimum switching frequency limit adaptation to output frequency active. This setting improves control performance at high output frequencies (typically above 120 Hz). | 3  | Custom sine filter | 1 = A custom sine filter is connected to the output of the drive/inverter. See also parameters <a href="#">97.01</a> , <a href="#">97.02</a> , <a href="#">99.18</a> , <a href="#">99.19</a> . | 4...15  | Reserved |  |  |
| Bit     | Name                       | Information   |            |      |             |   |          |   |   |                 |  |     |                 |   |    |                    |  |         |          |  |  |
| 0       | EX motor                   | 1 = The driven motor is an Ex motor provided by ABB for potentially explosive atmospheres. This sets the required minimum switching frequency for ABB Ex motors. <b>Note:</b> For non-ABB Ex motors, contact your local ABB representative.   |            |      |             |   |          |   |   |                 |  |     |                 |   |    |                    |  |         |          |  |  |
| 1       | ABB sine filter            | 1 = An ABB sine filter is connected to the output of the drive/inverter.  |            |      |             |   |          |   |   |                 |  |     |                 |   |    |                    |  |         |          |  |  |
| 2       | High speed mode            | 1 = Minimum switching frequency limit adaptation to output frequency active. This setting improves control performance at high output frequencies (typically above 120 Hz).   |            |      |             |   |          |   |   |                 |  |     |                 |   |    |                    |  |         |          |  |  |
| 3       | Custom sine filter         | 1 = A custom sine filter is connected to the output of the drive/inverter. See also parameters <a href="#">97.01</a> , <a href="#">97.02</a> , <a href="#">99.18</a> , <a href="#">99.19</a> .  |            |      |             |   |          |   |   |                 |  |     |                 |   |    |                    |  |         |          |  |  |
| 4...15  | Reserved                   |   |            |      |             |   |          |   |   |                 |  |     |                 |   |    |                    |  |         |          |  |  |
|         | 0000b...0111b              | Hardware options configuration word.  | 1 = 1      |      |             |   |          |   |   |                 |  |     |                 |   |    |                    |  |         |          |  |  |

| No.   | Name/Value        | Description   | Def/FbEq16 |
|-------|-------------------|---|------------|
| 95.20 | HW options word 1 | <p>Specifies hardware-related options that require differentiated parameter defaults. Activating a bit in this parameter makes the necessary changes in other parameters – for example, activating an emergency stop option reserves a digital input. In many cases, the differentiated parameters will also be write-protected.</p> <p>This parameter, as well as the changes in other parameters implemented by it, are not affected by a parameter restore.</p> <p> <b>WARNING!</b> After switching any bits in this word, recheck the values of the affected parameters.</p> | -          |

| Bit | Name                                  | Information  |
|-----|---------------------------------------|--|
| 0   | Supply frequency 60 Hz                | 0 = 50 Hz; 1 = 60 Hz. Affects parameters <a href="#">11.45</a> , <a href="#">11.59</a> , <a href="#">12.20</a> , <a href="#">13.18</a> , <a href="#">30.11</a> , <a href="#">30.12</a> , <a href="#">30.13</a> , <a href="#">30.14</a> , <a href="#">31.26</a> , <a href="#">31.27</a> , <a href="#">40.15</a> , <a href="#">40.37</a> , <a href="#">41.15</a> , <a href="#">41.37</a> , <a href="#">46.01</a> , <a href="#">46.02</a> . |
| 1   | Emergency stop Cat 0                  | 1 = Emergency stop, Category 0, without FSO module. Affects <a href="#">21.04</a> , <a href="#">21.05</a> , <a href="#">23.11</a> .  |
| 2   | Emergency stop Cat 1                  | 1 = Emergency stop, Category 1, without FSO module. Affects <a href="#">10.24</a> , <a href="#">21.04</a> , <a href="#">21.05</a> , <a href="#">23.11</a> .  |
| 3   | RO2 for -07 cabinet cooling fan       | 1 = Control of cabinet cooling fan (used only with specific ACS880-07 hardware). Affects <a href="#">10.27</a> , <a href="#">10.28</a> , <a href="#">10.29</a> .   |
| 4   | Externally powered control unit       | 1 = Control unit powered externally. Affects <a href="#">95.04</a> . (Only visible with a ZCU control unit)  |
| 5   | DC supply switch                      | 1 = DC switch monitoring active. Affects <a href="#">20.12</a> , <a href="#">31.03</a> , <a href="#">95.08</a> . (Only visible with a ZCU control unit)  |
| 6   | DOL motor switch                      | 1 = Motor fan control active. Affects <a href="#">10.24</a> , <a href="#">35.100</a> , <a href="#">35.103</a> , <a href="#">35.104</a> .   |
| 7   | xSFC-01 fuse switch controller        | 1 = xSFC charging controller used. Affects <a href="#">95.09</a> . (Only visible with a BCU control unit)  |
| 8   | Service switch                        | 1 = Service switch connected. Affects <a href="#">31.01</a> , <a href="#">31.02</a> .  |
| 9   | Output contactor                      | 1 = Output contactor present. Affects <a href="#">10.24</a> , <a href="#">20.12</a> .  |
| 10  | Brake resistor, sine filter, IP54 fan | 1 = Status (eg. thermal) switches connected to DIIL input. Affects <a href="#">20.11</a> , <a href="#">20.12</a> .   |
| 11  | INU-DSU communication                 | *1 = Diode supply unit control by inverter unit active. Makes several parameters visible in groups <a href="#">06</a> , <a href="#">60</a> , <a href="#">61</a> , <a href="#">62</a> and <a href="#">94</a> . (Only visible with a BCU control unit)   |
| 12  | Reserved                              |  |
| 13  | du/dt filter activation               | 1 = Active: An external du/dt filter is connected to the drive/inverter output. The setting will limit the output switching frequency, and force the fan of the drive/inverter module to full speed.<br><b>Note:</b> This bit is to be left at 0 if the drive/inverter module is equipped with internal du/dt filtering (for example, frame R8i inverter modules with option +E205).   |
| 14  | DOL fan activation                    | 1 = The inverter unit consists of frame R8i modules with direct-on-line cooling fans (option +C188). Disables fan feedback monitoring and changes fan control to ON/OFF type.  |
| 15  | INU-ISU communication                 | *1 = IGBT supply unit control by inverter unit active. Makes several parameters visible in groups <a href="#">01</a> , <a href="#">05</a> , <a href="#">06</a> , <a href="#">07</a> , <a href="#">30</a> , <a href="#">31</a> , <a href="#">60</a> , <a href="#">61</a> , <a href="#">62</a> , <a href="#">94</a> and <a href="#">96</a> .   |

\*See section [Control of a supply unit \(LSU\)](#) (page 40).

|               |  |       |
|---------------|--|-------|
| 0000h...FFFFh | Hardware options configuration word 1. | 1 = 1 |
|---------------|--|-------|

| No.   | Name/Value                           | Description  | Def/FbEq16          |     |      |             |   |          |  |   |       |   |   |            |  |        |          |  |
|---|--------------------------------------|--|---------------------|-----|------|-------------|---|----------|--|---|-------|---|---|------------|--|--------|----------|--|
| 95.21   | <i>HW options word 2</i>             | Specifies more hardware-related options that require differentiated parameter defaults. See parameter <a href="#">95.20 HW options word 1</a> .<br> <b>WARNING!</b> After switching any bits in this word, recheck the values of the affected parameters.   | -                   |     |      |             |   |          |  |   |       |   |   |            |  |        |          |  |
| <table border="1"> <thead> <tr> <th>Bit</th> <th>Name</th> <th>Information</th> </tr> </thead> <tbody> <tr> <td>0</td> <td>Dual use</td> <td>1 = Dual use active. For drives with option +N8200. (Allows higher output frequencies and frequency reference limits.)</td> </tr> <tr> <td>1</td> <td>SynRM</td> <td>1 = Synchronous reluctance motor used. Affects parameters <a href="#">25.02</a>, <a href="#">25.03</a>, <a href="#">25.15</a>, <a href="#">99.03</a>, <a href="#">99.13</a>.</td> </tr> <tr> <td>2</td> <td>Salient PM</td> <td>1 = Salient-pole permanent magnet motor used. Affects parameters <a href="#">25.02</a>, <a href="#">25.03</a>, <a href="#">25.15</a>, <a href="#">99.03</a>, <a href="#">99.13</a>.</td> </tr> <tr> <td>3...15</td> <td>Reserved</td> <td></td> </tr> </tbody> </table> |                                      |  |                     | Bit | Name | Information | 0 | Dual use | 1 = Dual use active. For drives with option +N8200. (Allows higher output frequencies and frequency reference limits.) | 1 | SynRM | 1 = Synchronous reluctance motor used. Affects parameters <a href="#">25.02</a> , <a href="#">25.03</a> , <a href="#">25.15</a> , <a href="#">99.03</a> , <a href="#">99.13</a> . | 2 | Salient PM | 1 = Salient-pole permanent magnet motor used. Affects parameters <a href="#">25.02</a> , <a href="#">25.03</a> , <a href="#">25.15</a> , <a href="#">99.03</a> , <a href="#">99.13</a> . | 3...15 | Reserved |  |
| Bit   | Name                                 | Information  |                     |     |      |             |   |          |  |   |       |   |   |            |  |        |          |  |
| 0   | Dual use                             | 1 = Dual use active. For drives with option +N8200. (Allows higher output frequencies and frequency reference limits.)   |                     |     |      |             |   |          |  |   |       |   |   |            |  |        |          |  |
| 1   | SynRM                                | 1 = Synchronous reluctance motor used. Affects parameters <a href="#">25.02</a> , <a href="#">25.03</a> , <a href="#">25.15</a> , <a href="#">99.03</a> , <a href="#">99.13</a> .  |                     |     |      |             |   |          |  |   |       |   |   |            |  |        |          |  |
| 2   | Salient PM                           | 1 = Salient-pole permanent magnet motor used. Affects parameters <a href="#">25.02</a> , <a href="#">25.03</a> , <a href="#">25.15</a> , <a href="#">99.03</a> , <a href="#">99.13</a> .   |                     |     |      |             |   |          |  |   |       |   |   |            |  |        |          |  |
| 3...15  | Reserved                             |  |                     |     |      |             |   |          |  |   |       |   |   |            |  |        |          |  |
|   | 0000b...0011b                        | Hardware options configuration word 2.   | 1 = 1               |     |      |             |   |          |  |   |       |   |   |            |  |        |          |  |
| 95.30   | <i>Parallel type filter</i>          | (Only visible with a BCU control unit)<br>Filters the list of drive/inverter types listed by parameter <a href="#">95.31 Parallel connection rating id</a> .   | <i>All types</i>    |     |      |             |   |          |  |   |       |   |   |            |  |        |          |  |
|   | All types                            | All types listed.  | 0                   |     |      |             |   |          |  |   |       |   |   |            |  |        |          |  |
|   | -3 (380-415V)                        | -3 (380...415 V) types listed.   | 1                   |     |      |             |   |          |  |   |       |   |   |            |  |        |          |  |
|   | -5 (380-500V)                        | -5 (380...500 V) types listed.   | 2                   |     |      |             |   |          |  |   |       |   |   |            |  |        |          |  |
|   | -7 (525-690V)                        | -7 (525...690 V) types listed.   | 3                   |     |      |             |   |          |  |   |       |   |   |            |  |        |          |  |
| 95.31   | <i>Parallel connection rating id</i> | (Only visible with a BCU control unit)<br>Defines the drive/inverter type if it consists of parallel-connected modules.<br>If the drive/inverter consists of a single module, leave the value at <i>Not selected</i> .   | <i>Not selected</i> |     |      |             |   |          |  |   |       |   |   |            |  |        |          |  |
|   | Not selected                         | The drive/inverter does not consist of parallel-connected modules, or type not selected.   | 0                   |     |      |             |   |          |  |   |       |   |   |            |  |        |          |  |
|   | [Drive/inverter type]                | Drive/inverter type consisting of parallel-connected modules.  | -                   |     |      |             |   |          |  |   |       |   |   |            |  |        |          |  |
| 95.40   | <i>Transformation ratio</i>          | Defines the ratio of the step-up transformer.  | 0.000               |     |      |             |   |          |  |   |       |   |   |            |  |        |          |  |
|   | 0.000 ... 100.000                    | Step-up transformer ratio.   |                     |     |      |             |   |          |  |   |       |   |   |            |  |        |          |  |
| <b>96 System</b>  |                                      | Language selection; access levels; macro selection; parameter save and restore; control unit reboot; user parameter sets; unit selection; data logger triggering; parameter checksum calculation; user lock.   |                     |     |      |             |   |          |  |   |       |   |   |            |  |        |          |  |
| 96.01   | <i>Language</i>                      | Selects the language of the parameter interface and other displayed information when viewed on the control panel.<br><b>Notes:</b> <ul style="list-style-type: none"> <li>Not all languages listed below are necessarily supported.</li> <li>This parameter does not affect the languages visible in the Drive composer PC tool. (Those are specified under View – Settings.)</li> </ul> | -                   |     |      |             |   |          |  |   |       |   |   |            |  |        |          |  |
|   | Not selected                         | None.  | 0                   |     |      |             |   |          |  |   |       |   |   |            |  |        |          |  |
|   | English                              | English.   | 1033                |     |      |             |   |          |  |   |       |   |   |            |  |        |          |  |
|   | Deutsch                              | German.  | 1031                |     |      |             |   |          |  |   |       |   |   |            |  |        |          |  |
|   | Italiano                             | Italian.   | 1040                |     |      |             |   |          |  |   |       |   |   |            |  |        |          |  |

## 406 Parameters

| No.   | Name/Value                | Description  | Def/FbEq16 |
|-------|---------------------------|--|------------|
|       | Español                   | Spanish.   | 3082       |
|       | Portugues                 | Portuguese.  | 2070       |
|       | Nederlands                | Dutch.   | 1043       |
|       | Français                  | French.  | 1036       |
|       | Dansk                     | Danish.  | 1030       |
|       | Suomi                     | Finnish.   | 1035       |
|       | Svenska                   | Swedish.   | 1053       |
|       | Russki                    | Russian.   | 1049       |
|       | Polski                    | Polish.  | 1045       |
|       | Czech                     | Czech.   | 1029       |
|       | Chinese (Simplified, PRC) | Simplified Chinese.  | 2052       |
|       | Türkçe                    | Turkish.   | 1055       |
|       | Japanese                  | Japanese.  | 1041       |
| 96.02 | <i>Pass code</i>          | <p>Pass codes can be entered into this parameter to activate further access levels (see parameter <a href="#">96.03 Access levels active</a>) or to configure the user lock.</p> <p>Entering “358” toggles the parameter lock, which prevents the changing of all other parameters through the control panel or the Drive composer PC tool.</p> <p>Entering the user pass code (by default, “10000000”) enables parameters <a href="#">96.100...96.102</a>, which can be used to define a new user pass code and to select the actions that are to be prevented.</p> <p>Entering an invalid pass code will close the user lock if open, ie. hide parameters <a href="#">96.100...96.102</a>. After entering the code, check that the parameters are in fact hidden. If they are not, enter another (random) pass code.</p> <p>Entering several invalid pass codes introduces a delay before a new attempt can be made. Entering further invalid codes will progressively lengthen the delay.</p> <p><b>Note:</b> You must change the default user pass code to maintain a high level of cybersecurity. <u>Store the code in a safe place – the protection cannot be disabled even by ABB if the code is lost.</u></p> <p>See also section <a href="#">User lock</a> (page <a href="#">91</a>).</p> | 0          |
|       | 0...99999999              | Pass code.   | -          |

| No.   | Name/Value                  | Description  | Def/FbEq16     |     |      |   |          |   |         |   |                     |        |          |    |                    |    |                    |    |                    |    |                |    |          |
|---|-----------------------------|--|----------------|-----|------|---|----------|---|---------|---|---------------------|--------|----------|----|--------------------|----|--------------------|----|--------------------|----|----------------|----|----------|
| 96.03   | <i>Access levels active</i> | Shows which access levels have been activated by pass codes entered into parameter <i>96.02 Pass code</i> .<br>This parameter is read-only.  | 0001h          |     |      |   |          |   |         |   |                     |        |          |    |                    |    |                    |    |                    |    |                |    |          |
| <table border="1"> <thead> <tr> <th>Bit</th> <th>Name</th> </tr> </thead> <tbody> <tr> <td>0</td> <td>End user</td> </tr> <tr> <td>1</td> <td>Service</td> </tr> <tr> <td>2</td> <td>Advanced programmer</td> </tr> <tr> <td>3...10</td> <td>Reserved</td> </tr> <tr> <td>11</td> <td>OEM access level 1</td> </tr> <tr> <td>12</td> <td>OEM access level 2</td> </tr> <tr> <td>13</td> <td>OEM access level 3</td> </tr> <tr> <td>14</td> <td>Parameter lock</td> </tr> <tr> <td>15</td> <td>Reserved</td> </tr> </tbody> </table> |                             |  |                | Bit | Name | 0 | End user | 1 | Service | 2 | Advanced programmer | 3...10 | Reserved | 11 | OEM access level 1 | 12 | OEM access level 2 | 13 | OEM access level 3 | 14 | Parameter lock | 15 | Reserved |
| Bit   | Name                        |  |                |     |      |   |          |   |         |   |                     |        |          |    |                    |    |                    |    |                    |    |                |    |          |
| 0   | End user                    |  |                |     |      |   |          |   |         |   |                     |        |          |    |                    |    |                    |    |                    |    |                |    |          |
| 1   | Service                     |  |                |     |      |   |          |   |         |   |                     |        |          |    |                    |    |                    |    |                    |    |                |    |          |
| 2   | Advanced programmer         |  |                |     |      |   |          |   |         |   |                     |        |          |    |                    |    |                    |    |                    |    |                |    |          |
| 3...10  | Reserved                    |  |                |     |      |   |          |   |         |   |                     |        |          |    |                    |    |                    |    |                    |    |                |    |          |
| 11  | OEM access level 1          |  |                |     |      |   |          |   |         |   |                     |        |          |    |                    |    |                    |    |                    |    |                |    |          |
| 12  | OEM access level 2          |  |                |     |      |   |          |   |         |   |                     |        |          |    |                    |    |                    |    |                    |    |                |    |          |
| 13  | OEM access level 3          |  |                |     |      |   |          |   |         |   |                     |        |          |    |                    |    |                    |    |                    |    |                |    |          |
| 14  | Parameter lock              |  |                |     |      |   |          |   |         |   |                     |        |          |    |                    |    |                    |    |                    |    |                |    |          |
| 15  | Reserved                    |  |                |     |      |   |          |   |         |   |                     |        |          |    |                    |    |                    |    |                    |    |                |    |          |
|   | 0000h...FFFFh               | Active access levels.  | -              |     |      |   |          |   |         |   |                     |        |          |    |                    |    |                    |    |                    |    |                |    |          |
| 96.04   | <i>Macro select</i>         | Selects the application macro. See chapter <i>Application macros</i> (page 95) for more information.<br>After a selection is made, the parameter reverts automatically to <i>Done</i> .      | <i>Done</i>    |     |      |   |          |   |         |   |                     |        |          |    |                    |    |                    |    |                    |    |                |    |          |
|   | Done                        | Macro selection complete; normal operation.  | 0              |     |      |   |          |   |         |   |                     |        |          |    |                    |    |                    |    |                    |    |                |    |          |
|   | Factory                     | Factory macro (see page 96).   | 1              |     |      |   |          |   |         |   |                     |        |          |    |                    |    |                    |    |                    |    |                |    |          |
|   | Hand/Auto                   | Hand/Auto macro (see page 98).   | 2              |     |      |   |          |   |         |   |                     |        |          |    |                    |    |                    |    |                    |    |                |    |          |
|   | PID-CTRL                    | PID control macro (see page 100).  | 3              |     |      |   |          |   |         |   |                     |        |          |    |                    |    |                    |    |                    |    |                |    |          |
|   | T-CTRL                      | Torque control macro (see page 104).   | 4              |     |      |   |          |   |         |   |                     |        |          |    |                    |    |                    |    |                    |    |                |    |          |
|   | Sequence control            | Sequential control macro (see page 106).   | 5              |     |      |   |          |   |         |   |                     |        |          |    |                    |    |                    |    |                    |    |                |    |          |
|   | FIELDBUS                    | Reserved.  | 6              |     |      |   |          |   |         |   |                     |        |          |    |                    |    |                    |    |                    |    |                |    |          |
| 96.05   | <i>Macro active</i>         | Shows which application macro is currently selected. See chapter <i>Application macros</i> (page 95) for more information.<br>To change the macro, use parameter <i>96.04 Macro select</i> . | <i>Factory</i> |     |      |   |          |   |         |   |                     |        |          |    |                    |    |                    |    |                    |    |                |    |          |
|   | Factory                     | Factory macro (see page 96).   | 1              |     |      |   |          |   |         |   |                     |        |          |    |                    |    |                    |    |                    |    |                |    |          |
|   | Hand/Auto                   | Hand/Auto macro (see page 98).   | 2              |     |      |   |          |   |         |   |                     |        |          |    |                    |    |                    |    |                    |    |                |    |          |
|   | PID-CTRL                    | PID control macro (see page 100).  | 3              |     |      |   |          |   |         |   |                     |        |          |    |                    |    |                    |    |                    |    |                |    |          |
|   | T-CTRL                      | Torque control macro (see page 104).   | 4              |     |      |   |          |   |         |   |                     |        |          |    |                    |    |                    |    |                    |    |                |    |          |
|   | Sequence control            | Sequential control macro (see page 106).   | 5              |     |      |   |          |   |         |   |                     |        |          |    |                    |    |                    |    |                    |    |                |    |          |
|   | FIELDBUS                    | Fieldbus control macro (see page 109).   | 6              |     |      |   |          |   |         |   |                     |        |          |    |                    |    |                    |    |                    |    |                |    |          |
| 96.06   | <i>Parameter restore</i>    | Restores the original settings of the control program, ie. parameter default values.<br><b>Note:</b> This parameter cannot be changed while the drive is running.                            | <i>Done</i>    |     |      |   |          |   |         |   |                     |        |          |    |                    |    |                    |    |                    |    |                |    |          |
|   | Done                        | Restoring is completed.  | 0              |     |      |   |          |   |         |   |                     |        |          |    |                    |    |                    |    |                    |    |                |    |          |

| No.                   | Name/Value                              | Description  | Def/FbEq16            |
|-----------------------|---|--|-----------------------|
|                       | Restore defaults                        | All editable parameter values are restored to default values, except <ul style="list-style-type: none"> <li>motor data and ID run results</li> <li>parameter <a href="#">31.42 Overcurrent fault limit</a></li> <li>control panel/PC communication settings</li> <li>I/O extension module settings</li> <li>fieldbus adapter settings</li> <li>encoder configuration data</li> <li>application macro selection and the parameter defaults implemented by it</li> <li>parameter <a href="#">95.01 Supply voltage</a></li> <li>parameter <a href="#">95.09 Switch fuse controller</a></li> <li>differentiated defaults implemented by parameters <a href="#">95.20 HW options word 1</a> and <a href="#">95.21 HW options word 2</a></li> <li>user lock configuration parameters <a href="#">96.100...96.102</a>.</li> </ul> | 8                     |
|                       | Clear all                               | All editable parameter values are restored to default values, except <ul style="list-style-type: none"> <li>control panel/PC communication settings</li> <li>application macro selection and the parameter defaults implemented by it</li> <li>parameter <a href="#">95.01 Supply voltage</a></li> <li>parameter <a href="#">95.09 Switch fuse controller</a></li> <li>differentiated defaults implemented by parameters <a href="#">95.20 HW options word 1</a> and <a href="#">95.21 HW options word 2</a></li> <li>user lock configuration parameters <a href="#">96.100...96.102</a>.</li> </ul> PC tool communication is interrupted during the restoring.  | 62                    |
|                       | Reset all fieldbus settings             | Fieldbus adapter and embedded fieldbus interface settings (parameter groups 50...58) are restored to default values. This will also restore the default settings of the fieldbus adapter if one is connected.  | 32                    |
| <a href="#">96.07</a> | <a href="#">Parameter save manually</a> | Saves the valid parameter values to permanent memory. This parameter should be used to store values sent from a fieldbus, or when using an external power supply to the control board as the supply might have a very short hold-up time when powered off.<br><b>Note:</b> A new parameter value is saved automatically when changed from the PC tool or control panel but not when altered through a fieldbus adapter connection.   | <a href="#">Done</a>  |
|                       | Done                                    | Save completed.  | 0                     |
|                       | Save                                    | Save in progress.  | 1                     |
| <a href="#">96.08</a> | <a href="#">Control board boot</a>      | Changing the value of this parameter to 1 reboots the control unit (without requiring a power off/on cycle of the complete drive module).<br>The value reverts to 0 automatically.   | 0                     |
|                       | 0...1                                   | 1 = Reboot the control unit.   | 1 = 1                 |
| <a href="#">96.09</a> | <a href="#">FSO reboot</a>              | Changing the value of (or the source selected by) this parameter from 0 to 1 reboots the optional FSO-xx safety functions module.<br><b>Note:</b> The value does not revert to 0 automatically.  | <a href="#">False</a> |
|                       | False                                   | 0.   | 0                     |
|                       | True                                    | 1.   | 1                     |
|                       | <a href="#">Other [bit]</a>             | Source selection (see <a href="#">Terms and abbreviations</a> on page <a href="#">112</a> ).   | -                     |



| No.   | Name/Value                | Description  | Def/FbEq16       |
|-------|---------------------------|--|------------------|
| 96.10 | <i>User set status</i>    | Shows the status of the user parameter sets. This parameter is read-only. See also section <i>User parameter sets</i> (page 90).   | -                |
|       | n/a                       | No user parameter sets have been saved.  | 0                |
|       | Loading                   | A user set is being loaded.  | 1                |
|       | Saving                    | A user set is being saved.   | 2                |
|       | Faulted                   | Invalid or empty parameter set.  | 3                |
|       | User set 1                | User set 1 has been loaded.  | 4                |
|       | User set 2                | User set 2 has been loaded.  | 5                |
|       | User set 3                | User set 3 has been loaded.  | 6                |
|       | User set 4                | User set 4 has been loaded.  | 7                |
| 96.11 | <i>User set save/load</i> | Enables the saving and restoring of up to four custom sets of parameter settings. See section <i>User parameter sets</i> (page 90).<br>The set that was in use before powering down the drive is in use after the next power-up.<br><b>Notes:</b> <ul style="list-style-type: none"> <li>Hardware configuration settings such as I/O extension module, fieldbus and encoder configuration parameters (groups 14...16, 51...56, 58 and 92...93, and parameters <i>50.01</i> and <i>50.31</i>), and forced input/output values (such as <i>10.03</i> and <i>10.04</i>) are not included in user parameter sets.</li> <li>Parameter changes made after loading a set are not automatically stored – they must be saved using this parameter.</li> </ul> | <i>No action</i> |
|       | No action                 | Load or save operation complete; normal operation.   | 0                |
|       | User set I/O mode         | Load user parameter set using parameters <i>96.12 User set I/O mode in1</i> and <i>96.13 User set I/O mode in2</i> .   | 1                |
|       | Load set 1                | Load user parameter set 1.   | 2                |
|       | Load set 2                | Load user parameter set 2.   | 3                |
|       | Load set 3                | Load user parameter set 3.   | 4                |
|       | Load set 4                | Load user parameter set 4.   | 5                |
|       | Save to set 1             | Save user parameter set 1.   | 18               |
|       | Save to set 2             | Save user parameter set 2.   | 19               |
|       | Save to set 3             | Save user parameter set 3.   | 20               |
|       | Save to set 4             | Save user parameter set 4.   | 21               |

## 410 Parameters

| No.                                    | Name/Value                             | Description   | Def/FbEq16                             |  |                             |   |            |                  |   |          |       |   |                  |                          |   |          |       |                     |             |                                  |        |          |  |            |
|--|--|---|--|--|-----------------------------|---|------------|------------------|---|----------|-------|---|------------------|--------------------------|---|----------|-------|---------------------|-------------|----------------------------------|--------|----------|--|------------|
| 96.12                                  | <i>User set I/O mode in1</i>           | When parameter 96.11 <i>User set save/load</i> is set to <i>User set I/O mode</i> , selects the user parameter set together with parameter 96.13 <i>User set I/O mode in2</i> as follows: <table border="1" data-bbox="478 353 1188 663"> <thead> <tr> <th>Status of source defined by par. 96.12</th> <th>Status of source defined by par. 96.13</th> <th>User parameter set selected</th> </tr> </thead> <tbody> <tr> <td>0</td> <td>0</td> <td>Set 1</td> </tr> <tr> <td>1</td> <td>0</td> <td>Set 2</td> </tr> <tr> <td>0</td> <td>1</td> <td>Set 3</td> </tr> <tr> <td>1</td> <td>1</td> <td>Set 4</td> </tr> </tbody> </table>      | Status of source defined by par. 96.12 | Status of source defined by par. 96.13 | User parameter set selected | 0 | 0          | Set 1            | 1 | 0        | Set 2 | 0 | 1                | Set 3                    | 1 | 1        | Set 4 | <i>Not selected</i> |             |                                  |        |          |  |            |
| Status of source defined by par. 96.12 | Status of source defined by par. 96.13 | User parameter set selected   |  |  |                             |   |            |                  |   |          |       |   |                  |                          |   |          |       |                     |             |                                  |        |          |  |            |
| 0                                      | 0                                      | Set 1   |  |  |                             |   |            |                  |   |          |       |   |                  |                          |   |          |       |                     |             |                                  |        |          |  |            |
| 1                                      | 0                                      | Set 2   |  |  |                             |   |            |                  |   |          |       |   |                  |                          |   |          |       |                     |             |                                  |        |          |  |            |
| 0                                      | 1                                      | Set 3   |  |  |                             |   |            |                  |   |          |       |   |                  |                          |   |          |       |                     |             |                                  |        |          |  |            |
| 1                                      | 1                                      | Set 4   |  |  |                             |   |            |                  |   |          |       |   |                  |                          |   |          |       |                     |             |                                  |        |          |  |            |
|  | Not selected                           | 0.  | 0                                      |  |                             |   |            |                  |   |          |       |   |                  |                          |   |          |       |                     |             |                                  |        |          |  |            |
|  | Selected                               | 1.  | 1                                      |  |                             |   |            |                  |   |          |       |   |                  |                          |   |          |       |                     |             |                                  |        |          |  |            |
|  | DI1                                    | Digital input DI1 ( <i>10.02 DI delayed status</i> , bit 0).  | 2                                      |  |                             |   |            |                  |   |          |       |   |                  |                          |   |          |       |                     |             |                                  |        |          |  |            |
|  | DI2                                    | Digital input DI2 ( <i>10.02 DI delayed status</i> , bit 1).  | 3                                      |  |                             |   |            |                  |   |          |       |   |                  |                          |   |          |       |                     |             |                                  |        |          |  |            |
|  | DI3                                    | Digital input DI3 ( <i>10.02 DI delayed status</i> , bit 2).  | 4                                      |  |                             |   |            |                  |   |          |       |   |                  |                          |   |          |       |                     |             |                                  |        |          |  |            |
|  | DI4                                    | Digital input DI4 ( <i>10.02 DI delayed status</i> , bit 3).  | 5                                      |  |                             |   |            |                  |   |          |       |   |                  |                          |   |          |       |                     |             |                                  |        |          |  |            |
|  | DI5                                    | Digital input DI5 ( <i>10.02 DI delayed status</i> , bit 4).  | 6                                      |  |                             |   |            |                  |   |          |       |   |                  |                          |   |          |       |                     |             |                                  |        |          |  |            |
|  | DI6                                    | Digital input DI6 ( <i>10.02 DI delayed status</i> , bit 5).  | 7                                      |  |                             |   |            |                  |   |          |       |   |                  |                          |   |          |       |                     |             |                                  |        |          |  |            |
|  | DIO1                                   | Digital input/output DIO1 ( <i>11.02 DIO delayed status</i> , bit 0).   | 10                                     |  |                             |   |            |                  |   |          |       |   |                  |                          |   |          |       |                     |             |                                  |        |          |  |            |
|  | DIO2                                   | Digital input/output DIO2 ( <i>11.02 DIO delayed status</i> , bit 1).   | 11                                     |  |                             |   |            |                  |   |          |       |   |                  |                          |   |          |       |                     |             |                                  |        |          |  |            |
|  | <i>Other [bit]</i>                     | Source selection (see <i>Terms and abbreviations</i> on page 112).  | -                                      |  |                             |   |            |                  |   |          |       |   |                  |                          |   |          |       |                     |             |                                  |        |          |  |            |
| 96.13                                  | <i>User set I/O mode in2</i>           | See parameter 96.12 <i>User set I/O mode in1</i> .  | <i>Not selected</i>                    |  |                             |   |            |                  |   |          |       |   |                  |                          |   |          |       |                     |             |                                  |        |          |  |            |
| 96.16                                  | <i>Unit selection</i>                  | Selects the unit of parameters indicating power, temperature and torque. <table border="1" data-bbox="222 1397 1357 1774"> <thead> <tr> <th>Bit</th> <th>Name</th> <th>Information</th> </tr> </thead> <tbody> <tr> <td>0</td> <td>Power unit</td> <td>0 = kW<br/>1 = hp</td> </tr> <tr> <td>1</td> <td>Reserved</td> <td></td> </tr> <tr> <td>2</td> <td>Temperature unit</td> <td>0 = C (°C)<br/>1 = F (°F)</td> </tr> <tr> <td>3</td> <td>Reserved</td> <td></td> </tr> <tr> <td>4</td> <td>Torque unit</td> <td>0 = Nm (N·m)<br/>1 = lbft (lb·ft)</td> </tr> <tr> <td>5...15</td> <td>Reserved</td> <td></td> </tr> </tbody> </table> | Bit                                    | Name                                   | Information                 | 0 | Power unit | 0 = kW<br>1 = hp | 1 | Reserved |       | 2 | Temperature unit | 0 = C (°C)<br>1 = F (°F) | 3 | Reserved |       | 4                   | Torque unit | 0 = Nm (N·m)<br>1 = lbft (lb·ft) | 5...15 | Reserved |  | 0000 0000b |
| Bit                                    | Name                                   | Information   |  |  |                             |   |            |                  |   |          |       |   |                  |                          |   |          |       |                     |             |                                  |        |          |  |            |
| 0                                      | Power unit                             | 0 = kW<br>1 = hp  |  |  |                             |   |            |                  |   |          |       |   |                  |                          |   |          |       |                     |             |                                  |        |          |  |            |
| 1                                      | Reserved                               |   |  |  |                             |   |            |                  |   |          |       |   |                  |                          |   |          |       |                     |             |                                  |        |          |  |            |
| 2                                      | Temperature unit                       | 0 = C (°C)<br>1 = F (°F)  |  |  |                             |   |            |                  |   |          |       |   |                  |                          |   |          |       |                     |             |                                  |        |          |  |            |
| 3                                      | Reserved                               |   |  |  |                             |   |            |                  |   |          |       |   |                  |                          |   |          |       |                     |             |                                  |        |          |  |            |
| 4                                      | Torque unit                            | 0 = Nm (N·m)<br>1 = lbft (lb·ft)  |  |  |                             |   |            |                  |   |          |       |   |                  |                          |   |          |       |                     |             |                                  |        |          |  |            |
| 5...15                                 | Reserved                               |   |  |  |                             |   |            |                  |   |          |       |   |                  |                          |   |          |       |                     |             |                                  |        |          |  |            |
|  | 0000 0000b ...<br>0001 0101b           | Unit selection word.  | 1 = 1                                  |  |                             |   |            |                  |   |          |       |   |                  |                          |   |          |       |                     |             |                                  |        |          |  |            |
| 96.20                                  | <i>Time sync primary source</i>        | Defines the 1st priority external source for synchronization of the drive's time and date.<br>The date and time can also be directly set into 96.24...96.26 in which case this parameter is ignored.  | <i>DDCS Controller</i>                 |  |                             |   |            |                  |   |          |       |   |                  |                          |   |          |       |                     |             |                                  |        |          |  |            |
|  | Internal                               | No external source selected.  | 0                                      |  |                             |   |            |                  |   |          |       |   |                  |                          |   |          |       |                     |             |                                  |        |          |  |            |

| No.          | Name/Value                                      | Description   | Def/FbEq16      |
|--------------|---|---|-----------------|
|              | DDCS Controller                                 | External controller.  | 1               |
|              | Fieldbus A or B                                 | Fieldbus interface A or B.  | 2               |
|              | Fieldbus A                                      | Fieldbus interface A.   | 3               |
|              | Fieldbus B                                      | Fieldbus interface B.   | 4               |
|              | D2D or M/F                                      | The master station on a master/follower or drive-to-drive link.   | 5               |
|              | Embedded FB                                     | Embedded fieldbus interface.  | 6               |
|              | Embedded Ethernet                               | Ethernet port on type BCU control unit.   | 7               |
|              | Panel link                                      | Control panel, or Drive composer PC tool connected to the control panel.  | 8               |
|              | Ethernet tool link                              | Drive composer PC tool through an FENA module.  | 9               |
| <b>96.23</b> | <b><i>M/F and D2D clock synchronization</i></b> | In the master drive, activates clock synchronization for master/follower and drive-to-drive communication.  | <i>Inactive</i> |
|              | Inactive  | Clock synchronization not active.   | 0               |
|              | Active  | Clock synchronization active.   | 1               |
| <b>96.24</b> | <b><i>Full days since 1st Jan 1980</i></b>      | Number of full days passed since beginning of the year 1980. This parameter, together with <b>96.25 Time in minutes within 24 h</b> and <b>96.26 Time in ms within one minute</b> makes it possible to set the date and time in the drive via the parameter interface from a fieldbus or application program. This may be necessary if the fieldbus protocol does not support time synchronization. | -               |
|              | 1...59999                                       | Days since beginning of 1980.   | 1 = 1           |
| <b>96.25</b> | <b><i>Time in minutes within 24 h</i></b>       | Number of full minutes passed since midnight. For example, the value 860 corresponds to 2:20 pm. See parameter <b>96.24 Full days since 1st Jan 1980</b> .  | 0 min           |
|              | 1...1439  | Minutes since midnight.   | 1 = 1           |
| <b>96.26</b> | <b><i>Time in ms within one minute</i></b>      | Number of milliseconds passed since last minute. See parameter <b>96.24 Full days since 1st Jan 1980</b> .  | 0 ms            |
|              | 0...59999                                       | Number of milliseconds since last minute.   | 1 = 1           |

## 412 Parameters

| No.   | Name/Value                     | Description  | Def/FbEq16    |      |             |   |                    |   |   |                        |  |   |                           |   |   |                 |  |   |                 |   |   |          |  |   |     |  |   |       |   |   |       |   |   |     |  |    |          |   |    |            |   |    |                    |   |    |                   |  |    |     |   |    |               |   |  |
|-------|--------------------------------|--|---------------|------|-------------|---|--------------------|---|---|------------------------|--|---|---------------------------|---|---|-----------------|--|---|-----------------|---|---|----------|--|---|-----|--|---|-------|---|---|-------|---|---|-----|--|----|----------|---|----|------------|---|----|--------------------|---|----|-------------------|--|----|-----|---|----|---------------|---|--|
| 96.29 | <i>Time sync source status</i> | Time source status word.<br>This parameter is read-only.   | -             |      |             |   |                    |   |   |                        |  |   |                           |   |   |                 |  |   |                 |   |   |          |  |   |     |  |   |       |   |   |       |   |   |     |  |    |          |   |    |            |   |    |                    |   |    |                   |  |    |     |   |    |               |   |  |
|       |                                | <table border="1"> <thead> <tr> <th>Bit</th> <th>Name</th> <th>Description</th> </tr> </thead> <tbody> <tr> <td>0</td> <td>Time tick received</td> <td>1 = 1st priority tick received: Tick has been received from 1st priority source (or from <a href="#">96.24</a>...<a href="#">96.26</a>).</td> </tr> <tr> <td>1</td> <td>Aux Time tick received</td> <td>1 = 2nd priority tick received: Tick has been received from 2nd priority source.</td> </tr> <tr> <td>2</td> <td>Tick interval is too long</td> <td>1 = Yes: Tick interval too long (accuracy compromised).</td> </tr> <tr> <td>3</td> <td>DDCS controller</td> <td>1 = Tick received: Tick has been received from an external controller.</td> </tr> <tr> <td>4</td> <td>Master/Follower</td> <td>1 = Tick received: Tick has been received through the master/follower link.</td> </tr> <tr> <td>5</td> <td>Reserved</td> <td></td> </tr> <tr> <td>6</td> <td>D2D</td> <td>1 = Tick received: Tick has been received through the drive-to-drive link.</td> </tr> <tr> <td>7</td> <td>FbusA</td> <td>1 = Tick received: Tick has been received through fieldbus interface A.</td> </tr> <tr> <td>8</td> <td>FbusB</td> <td>1 = Tick received: Tick has been received through fieldbus interface B.</td> </tr> <tr> <td>9</td> <td>EFB</td> <td>1 = Tick received: Tick has been received through the embedded fieldbus interface.</td> </tr> <tr> <td>10</td> <td>Ethernet</td> <td>1 = Tick received: Tick has been received through the Ethernet port on type BCU control unit.</td> </tr> <tr> <td>11</td> <td>Panel link</td> <td>1 = Tick received: Tick has been received from the control panel, or Drive composer PC tool connected to the control panel.</td> </tr> <tr> <td>12</td> <td>Ethernet tool link</td> <td>1 = Tick received: Tick has been received from Drive composer PC tool through an FENA module.</td> </tr> <tr> <td>13</td> <td>Parameter setting</td> <td>1 = Tick received: Tick has been set by parameters <a href="#">96.24</a>...<a href="#">96.26</a>.</td> </tr> <tr> <td>14</td> <td>RTC</td> <td>1 = RTC time in use: Time and date have been read from the real-time clock.</td> </tr> <tr> <td>15</td> <td>Drive On-Time</td> <td>1 = Drive on-time in use: Time and date are displaying drive on-time.</td> </tr> </tbody> </table> | Bit           | Name | Description | 0 | Time tick received | 1 = 1st priority tick received: Tick has been received from 1st priority source (or from <a href="#">96.24</a> ... <a href="#">96.26</a> ). | 1 | Aux Time tick received | 1 = 2nd priority tick received: Tick has been received from 2nd priority source. | 2 | Tick interval is too long | 1 = Yes: Tick interval too long (accuracy compromised). | 3 | DDCS controller | 1 = Tick received: Tick has been received from an external controller. | 4 | Master/Follower | 1 = Tick received: Tick has been received through the master/follower link. | 5 | Reserved |  | 6 | D2D | 1 = Tick received: Tick has been received through the drive-to-drive link. | 7 | FbusA | 1 = Tick received: Tick has been received through fieldbus interface A. | 8 | FbusB | 1 = Tick received: Tick has been received through fieldbus interface B. | 9 | EFB | 1 = Tick received: Tick has been received through the embedded fieldbus interface. | 10 | Ethernet | 1 = Tick received: Tick has been received through the Ethernet port on type BCU control unit. | 11 | Panel link | 1 = Tick received: Tick has been received from the control panel, or Drive composer PC tool connected to the control panel. | 12 | Ethernet tool link | 1 = Tick received: Tick has been received from Drive composer PC tool through an FENA module. | 13 | Parameter setting | 1 = Tick received: Tick has been set by parameters <a href="#">96.24</a> ... <a href="#">96.26</a> . | 14 | RTC | 1 = RTC time in use: Time and date have been read from the real-time clock. | 15 | Drive On-Time | 1 = Drive on-time in use: Time and date are displaying drive on-time. |  |
| Bit   | Name                           | Description  |               |      |             |   |                    |   |   |                        |  |   |                           |   |   |                 |  |   |                 |   |   |          |  |   |     |  |   |       |   |   |       |   |   |     |  |    |          |   |    |            |   |    |                    |   |    |                   |  |    |     |   |    |               |   |  |
| 0     | Time tick received             | 1 = 1st priority tick received: Tick has been received from 1st priority source (or from <a href="#">96.24</a> ... <a href="#">96.26</a> ).  |               |      |             |   |                    |   |   |                        |  |   |                           |   |   |                 |  |   |                 |   |   |          |  |   |     |  |   |       |   |   |       |   |   |     |  |    |          |   |    |            |   |    |                    |   |    |                   |  |    |     |   |    |               |   |  |
| 1     | Aux Time tick received         | 1 = 2nd priority tick received: Tick has been received from 2nd priority source.   |               |      |             |   |                    |   |   |                        |  |   |                           |   |   |                 |  |   |                 |   |   |          |  |   |     |  |   |       |   |   |       |   |   |     |  |    |          |   |    |            |   |    |                    |   |    |                   |  |    |     |   |    |               |   |  |
| 2     | Tick interval is too long      | 1 = Yes: Tick interval too long (accuracy compromised).  |               |      |             |   |                    |   |   |                        |  |   |                           |   |   |                 |  |   |                 |   |   |          |  |   |     |  |   |       |   |   |       |   |   |     |  |    |          |   |    |            |   |    |                    |   |    |                   |  |    |     |   |    |               |   |  |
| 3     | DDCS controller                | 1 = Tick received: Tick has been received from an external controller.   |               |      |             |   |                    |   |   |                        |  |   |                           |   |   |                 |  |   |                 |   |   |          |  |   |     |  |   |       |   |   |       |   |   |     |  |    |          |   |    |            |   |    |                    |   |    |                   |  |    |     |   |    |               |   |  |
| 4     | Master/Follower                | 1 = Tick received: Tick has been received through the master/follower link.  |               |      |             |   |                    |   |   |                        |  |   |                           |   |   |                 |  |   |                 |   |   |          |  |   |     |  |   |       |   |   |       |   |   |     |  |    |          |   |    |            |   |    |                    |   |    |                   |  |    |     |   |    |               |   |  |
| 5     | Reserved                       |  |               |      |             |   |                    |   |   |                        |  |   |                           |   |   |                 |  |   |                 |   |   |          |  |   |     |  |   |       |   |   |       |   |   |     |  |    |          |   |    |            |   |    |                    |   |    |                   |  |    |     |   |    |               |   |  |
| 6     | D2D                            | 1 = Tick received: Tick has been received through the drive-to-drive link.   |               |      |             |   |                    |   |   |                        |  |   |                           |   |   |                 |  |   |                 |   |   |          |  |   |     |  |   |       |   |   |       |   |   |     |  |    |          |   |    |            |   |    |                    |   |    |                   |  |    |     |   |    |               |   |  |
| 7     | FbusA                          | 1 = Tick received: Tick has been received through fieldbus interface A.  |               |      |             |   |                    |   |   |                        |  |   |                           |   |   |                 |  |   |                 |   |   |          |  |   |     |  |   |       |   |   |       |   |   |     |  |    |          |   |    |            |   |    |                    |   |    |                   |  |    |     |   |    |               |   |  |
| 8     | FbusB                          | 1 = Tick received: Tick has been received through fieldbus interface B.  |               |      |             |   |                    |   |   |                        |  |   |                           |   |   |                 |  |   |                 |   |   |          |  |   |     |  |   |       |   |   |       |   |   |     |  |    |          |   |    |            |   |    |                    |   |    |                   |  |    |     |   |    |               |   |  |
| 9     | EFB                            | 1 = Tick received: Tick has been received through the embedded fieldbus interface.   |               |      |             |   |                    |   |   |                        |  |   |                           |   |   |                 |  |   |                 |   |   |          |  |   |     |  |   |       |   |   |       |   |   |     |  |    |          |   |    |            |   |    |                    |   |    |                   |  |    |     |   |    |               |   |  |
| 10    | Ethernet                       | 1 = Tick received: Tick has been received through the Ethernet port on type BCU control unit.  |               |      |             |   |                    |   |   |                        |  |   |                           |   |   |                 |  |   |                 |   |   |          |  |   |     |  |   |       |   |   |       |   |   |     |  |    |          |   |    |            |   |    |                    |   |    |                   |  |    |     |   |    |               |   |  |
| 11    | Panel link                     | 1 = Tick received: Tick has been received from the control panel, or Drive composer PC tool connected to the control panel.  |               |      |             |   |                    |   |   |                        |  |   |                           |   |   |                 |  |   |                 |   |   |          |  |   |     |  |   |       |   |   |       |   |   |     |  |    |          |   |    |            |   |    |                    |   |    |                   |  |    |     |   |    |               |   |  |
| 12    | Ethernet tool link             | 1 = Tick received: Tick has been received from Drive composer PC tool through an FENA module.  |               |      |             |   |                    |   |   |                        |  |   |                           |   |   |                 |  |   |                 |   |   |          |  |   |     |  |   |       |   |   |       |   |   |     |  |    |          |   |    |            |   |    |                    |   |    |                   |  |    |     |   |    |               |   |  |
| 13    | Parameter setting              | 1 = Tick received: Tick has been set by parameters <a href="#">96.24</a> ... <a href="#">96.26</a> .   |               |      |             |   |                    |   |   |                        |  |   |                           |   |   |                 |  |   |                 |   |   |          |  |   |     |  |   |       |   |   |       |   |   |     |  |    |          |   |    |            |   |    |                    |   |    |                   |  |    |     |   |    |               |   |  |
| 14    | RTC                            | 1 = RTC time in use: Time and date have been read from the real-time clock.  |               |      |             |   |                    |   |   |                        |  |   |                           |   |   |                 |  |   |                 |   |   |          |  |   |     |  |   |       |   |   |       |   |   |     |  |    |          |   |    |            |   |    |                    |   |    |                   |  |    |     |   |    |               |   |  |
| 15    | Drive On-Time                  | 1 = Drive on-time in use: Time and date are displaying drive on-time.  |               |      |             |   |                    |   |   |                        |  |   |                           |   |   |                 |  |   |                 |   |   |          |  |   |     |  |   |       |   |   |       |   |   |     |  |    |          |   |    |            |   |    |                    |   |    |                   |  |    |     |   |    |               |   |  |
|       | 0000h...FFFFh                  | Time source status word 1.   | 1 = 1         |      |             |   |                    |   |   |                        |  |   |                           |   |   |                 |  |   |                 |   |   |          |  |   |     |  |   |       |   |   |       |   |   |     |  |    |          |   |    |            |   |    |                    |   |    |                   |  |    |     |   |    |               |   |  |
| 96.31 | <i>Drive ID number</i>         | Specifies an ID number for the drive. The ID can be read by an external controller through DDCS, for example, for comparison with an ID contained by the controller's application.   | 0             |      |             |   |                    |   |   |                        |  |   |                           |   |   |                 |  |   |                 |   |   |          |  |   |     |  |   |       |   |   |       |   |   |     |  |    |          |   |    |            |   |    |                    |   |    |                   |  |    |     |   |    |               |   |  |
|       | 0...32767                      | ID number.   | 1 = 1         |      |             |   |                    |   |   |                        |  |   |                           |   |   |                 |  |   |                 |   |   |          |  |   |     |  |   |       |   |   |       |   |   |     |  |    |          |   |    |            |   |    |                    |   |    |                   |  |    |     |   |    |               |   |  |
| 96.39 | <i>Power up event logging</i>  | Enables/disables power-up logging. When enabled, an event ( <a href="#">B5A2 Power up</a> ) is logged by the drive upon each power-up.   | <i>Enable</i> |      |             |   |                    |   |   |                        |  |   |                           |   |   |                 |  |   |                 |   |   |          |  |   |     |  |   |       |   |   |       |   |   |     |  |    |          |   |    |            |   |    |                    |   |    |                   |  |    |     |   |    |               |   |  |
|       | Disable                        | Power-up event logging disabled.   | 0             |      |             |   |                    |   |   |                        |  |   |                           |   |   |                 |  |   |                 |   |   |          |  |   |     |  |   |       |   |   |       |   |   |     |  |    |          |   |    |            |   |    |                    |   |    |                   |  |    |     |   |    |               |   |  |
|       | Enable                         | Power-up event logging enabled.  | 1             |      |             |   |                    |   |   |                        |  |   |                           |   |   |                 |  |   |                 |   |   |          |  |   |     |  |   |       |   |   |       |   |   |     |  |    |          |   |    |            |   |    |                    |   |    |                   |  |    |     |   |    |               |   |  |

| No.    | Name/Value                   | Description   | Def/FbEq16       |      |             |   |                     |  |   |                     |  |   |                     |  |   |                     |  |   |                         |   |   |                         |   |   |                         |   |   |                         |   |        |          |  |  |
|--------|------------------------------|---|------------------|------|-------------|---|---------------------|--|---|---------------------|--|---|---------------------|--|---|---------------------|--|---|-------------------------|---|---|-------------------------|---|---|-------------------------|---|---|-------------------------|---|--------|----------|--|--|
| 96.53  | <i>Actual checksum</i>       | Displays the actual parameter configuration checksum. The checksum is generated and updated whenever an action is selected in <a href="#">96.54 Checksum action</a> .<br>The parameters included in the calculation have been pre-selected, but the selection can be edited using the Drive customizer PC tool.<br>See also section <a href="#">Parameter checksum calculation</a> (page 90).   | 0h               |      |             |   |                     |  |   |                     |  |   |                     |  |   |                     |  |   |                         |   |   |                         |   |   |                         |   |   |                         |   |        |          |  |  |
|        | 00000000h...<br>FFFFFFFFh    | Actual checksum.  | -                |      |             |   |                     |  |   |                     |  |   |                     |  |   |                     |  |   |                         |   |   |                         |   |   |                         |   |   |                         |   |        |          |  |  |
| 96.54  | <i>Checksum action</i>       | Selects how the drive reacts if the parameter checksum ( <a href="#">96.53 Actual checksum</a> ) does not match any of the active approved checksums ( <a href="#">96.56...96.59</a> ). The active checksums are selected by <a href="#">96.55 Checksum control word</a> .  | <i>No action</i> |      |             |   |                     |  |   |                     |  |   |                     |  |   |                     |  |   |                         |   |   |                         |   |   |                         |   |   |                         |   |        |          |  |  |
|        | No action                    | No action taken. (The checksum feature is not in use.)  | 0                |      |             |   |                     |  |   |                     |  |   |                     |  |   |                     |  |   |                         |   |   |                         |   |   |                         |   |   |                         |   |        |          |  |  |
|        | Pure event                   | The drive generates an event log entry ( <a href="#">B686 Checksum mismatch</a> ).  | 1                |      |             |   |                     |  |   |                     |  |   |                     |  |   |                     |  |   |                         |   |   |                         |   |   |                         |   |   |                         |   |        |          |  |  |
|        | Warning                      | The drive generates a warning ( <a href="#">A686 Checksum mismatch</a> ).   | 2                |      |             |   |                     |  |   |                     |  |   |                     |  |   |                     |  |   |                         |   |   |                         |   |   |                         |   |   |                         |   |        |          |  |  |
|        | Warning and prevent start    | The drive generates a warning ( <a href="#">A686 Checksum mismatch</a> ). Starting the drive is prevented.  | 3                |      |             |   |                     |  |   |                     |  |   |                     |  |   |                     |  |   |                         |   |   |                         |   |   |                         |   |   |                         |   |        |          |  |  |
|        | Fault                        | The drive trips on <a href="#">6200 Checksum mismatch</a> .   | 4                |      |             |   |                     |  |   |                     |  |   |                     |  |   |                     |  |   |                         |   |   |                         |   |   |                         |   |   |                         |   |        |          |  |  |
| 96.55  | <i>Checksum control word</i> | Bits 0...3 select to which approved checksums (out of <a href="#">96.56...96.59</a> ) the actual checksum ( <a href="#">96.53</a> ) is compared.<br>Bits 4...7 select an approved (reference) checksum parameter ( <a href="#">96.56...96.59</a> ) into which the actual checksum from parameter <a href="#">96.53</a> is copied.   | 00000000b        |      |             |   |                     |  |   |                     |  |   |                     |  |   |                     |  |   |                         |   |   |                         |   |   |                         |   |   |                         |   |        |          |  |  |
|        |                              | <table border="1"> <thead> <tr> <th>Bit</th> <th>Name</th> <th>Description</th> </tr> </thead> <tbody> <tr> <td>0</td> <td>Approved checksum 1</td> <td>1 = Enabled: Checksum 1 (<a href="#">96.56</a>) is observed.</td> </tr> <tr> <td>1</td> <td>Approved checksum 2</td> <td>1 = Enabled: Checksum 2 (<a href="#">96.57</a>) is observed.</td> </tr> <tr> <td>2</td> <td>Approved checksum 3</td> <td>1 = Enabled: Checksum 3 (<a href="#">96.58</a>) is observed.</td> </tr> <tr> <td>3</td> <td>Approved checksum 4</td> <td>1 = Enabled: Checksum 4 (<a href="#">96.59</a>) is observed.</td> </tr> <tr> <td>4</td> <td>Set approved checksum 1</td> <td>1 = Set: Copy value of <a href="#">96.53</a> into <a href="#">96.56</a>.</td> </tr> <tr> <td>5</td> <td>Set approved checksum 2</td> <td>1 = Set: Copy value of <a href="#">96.53</a> into <a href="#">96.57</a>.</td> </tr> <tr> <td>6</td> <td>Set approved checksum 3</td> <td>1 = Set: Copy value of <a href="#">96.53</a> into <a href="#">96.58</a>.</td> </tr> <tr> <td>7</td> <td>Set approved checksum 4</td> <td>1 = Set: Copy value of <a href="#">96.53</a> into <a href="#">96.59</a>.</td> </tr> <tr> <td>8...15</td> <td>Reserved</td> <td></td> </tr> </tbody> </table> | Bit              | Name | Description | 0 | Approved checksum 1 | 1 = Enabled: Checksum 1 ( <a href="#">96.56</a> ) is observed. | 1 | Approved checksum 2 | 1 = Enabled: Checksum 2 ( <a href="#">96.57</a> ) is observed. | 2 | Approved checksum 3 | 1 = Enabled: Checksum 3 ( <a href="#">96.58</a> ) is observed. | 3 | Approved checksum 4 | 1 = Enabled: Checksum 4 ( <a href="#">96.59</a> ) is observed. | 4 | Set approved checksum 1 | 1 = Set: Copy value of <a href="#">96.53</a> into <a href="#">96.56</a> . | 5 | Set approved checksum 2 | 1 = Set: Copy value of <a href="#">96.53</a> into <a href="#">96.57</a> . | 6 | Set approved checksum 3 | 1 = Set: Copy value of <a href="#">96.53</a> into <a href="#">96.58</a> . | 7 | Set approved checksum 4 | 1 = Set: Copy value of <a href="#">96.53</a> into <a href="#">96.59</a> . | 8...15 | Reserved |  |  |
| Bit    | Name                         | Description   |                  |      |             |   |                     |  |   |                     |  |   |                     |  |   |                     |  |   |                         |   |   |                         |   |   |                         |   |   |                         |   |        |          |  |  |
| 0      | Approved checksum 1          | 1 = Enabled: Checksum 1 ( <a href="#">96.56</a> ) is observed.  |                  |      |             |   |                     |  |   |                     |  |   |                     |  |   |                     |  |   |                         |   |   |                         |   |   |                         |   |   |                         |   |        |          |  |  |
| 1      | Approved checksum 2          | 1 = Enabled: Checksum 2 ( <a href="#">96.57</a> ) is observed.  |                  |      |             |   |                     |  |   |                     |  |   |                     |  |   |                     |  |   |                         |   |   |                         |   |   |                         |   |   |                         |   |        |          |  |  |
| 2      | Approved checksum 3          | 1 = Enabled: Checksum 3 ( <a href="#">96.58</a> ) is observed.  |                  |      |             |   |                     |  |   |                     |  |   |                     |  |   |                     |  |   |                         |   |   |                         |   |   |                         |   |   |                         |   |        |          |  |  |
| 3      | Approved checksum 4          | 1 = Enabled: Checksum 4 ( <a href="#">96.59</a> ) is observed.  |                  |      |             |   |                     |  |   |                     |  |   |                     |  |   |                     |  |   |                         |   |   |                         |   |   |                         |   |   |                         |   |        |          |  |  |
| 4      | Set approved checksum 1      | 1 = Set: Copy value of <a href="#">96.53</a> into <a href="#">96.56</a> .   |                  |      |             |   |                     |  |   |                     |  |   |                     |  |   |                     |  |   |                         |   |   |                         |   |   |                         |   |   |                         |   |        |          |  |  |
| 5      | Set approved checksum 2      | 1 = Set: Copy value of <a href="#">96.53</a> into <a href="#">96.57</a> .   |                  |      |             |   |                     |  |   |                     |  |   |                     |  |   |                     |  |   |                         |   |   |                         |   |   |                         |   |   |                         |   |        |          |  |  |
| 6      | Set approved checksum 3      | 1 = Set: Copy value of <a href="#">96.53</a> into <a href="#">96.58</a> .   |                  |      |             |   |                     |  |   |                     |  |   |                     |  |   |                     |  |   |                         |   |   |                         |   |   |                         |   |   |                         |   |        |          |  |  |
| 7      | Set approved checksum 4      | 1 = Set: Copy value of <a href="#">96.53</a> into <a href="#">96.59</a> .   |                  |      |             |   |                     |  |   |                     |  |   |                     |  |   |                     |  |   |                         |   |   |                         |   |   |                         |   |   |                         |   |        |          |  |  |
| 8...15 | Reserved                     |   |                  |      |             |   |                     |  |   |                     |  |   |                     |  |   |                     |  |   |                         |   |   |                         |   |   |                         |   |   |                         |   |        |          |  |  |
|        | 00000000b...<br>11111111b    | Checksum control word.  | 1 = 1            |      |             |   |                     |  |   |                     |  |   |                     |  |   |                     |  |   |                         |   |   |                         |   |   |                         |   |   |                         |   |        |          |  |  |
| 96.56  | <i>Approved checksum 1</i>   | Approved (reference) checksum 1.  | 0h               |      |             |   |                     |  |   |                     |  |   |                     |  |   |                     |  |   |                         |   |   |                         |   |   |                         |   |   |                         |   |        |          |  |  |
|        | 00000000h...<br>FFFFFFFFh    | Approved checksum 1.  | -                |      |             |   |                     |  |   |                     |  |   |                     |  |   |                     |  |   |                         |   |   |                         |   |   |                         |   |   |                         |   |        |          |  |  |
| 96.57  | <i>Approved checksum 2</i>   | Approved (reference) checksum 2.  | 0h               |      |             |   |                     |  |   |                     |  |   |                     |  |   |                     |  |   |                         |   |   |                         |   |   |                         |   |   |                         |   |        |          |  |  |
|        | 00000000h...<br>FFFFFFFFh    | Approved checksum 2.  | -                |      |             |   |                     |  |   |                     |  |   |                     |  |   |                     |  |   |                         |   |   |                         |   |   |                         |   |   |                         |   |        |          |  |  |

## 414 Parameters

| No.  | Name/Value                            | Description  | Def/FbEq16   |     |      |             |   |         |   |   |           |   |   |                |   |   |            |  |        |          |  |
|--|---------------------------------------|--|--------------|-----|------|-------------|---|---------|---|---|-----------|---|---|----------------|---|---|------------|--|--------|----------|--|
| 96.58  | <i>Approved checksum 3</i>            | Approved (reference) checksum 3.   | 0h           |     |      |             |   |         |   |   |           |   |   |                |   |   |            |  |        |          |  |
|  | 0000000h...<br>FFFFFFFFh              | Approved checksum 3.   | -            |     |      |             |   |         |   |   |           |   |   |                |   |   |            |  |        |          |  |
| 96.59  | <i>Approved checksum 4</i>            | Approved (reference) checksum 4.   | 0h           |     |      |             |   |         |   |   |           |   |   |                |   |   |            |  |        |          |  |
|  | 0000000h...<br>FFFFFFFFh              | Approved checksum 4.   | -            |     |      |             |   |         |   |   |           |   |   |                |   |   |            |  |        |          |  |
| 96.61  | <i>User data logger status word</i>   | Provides status information on the user data logger (see page 489).  | 0000b        |     |      |             |   |         |   |   |           |   |   |                |   |   |            |  |        |          |  |
| <table border="1"> <thead> <tr> <th>Bit</th> <th>Name</th> <th>Description</th> </tr> </thead> <tbody> <tr> <td>0</td> <td>Running</td> <td>1 = The user data logger is running. The bit is cleared after the post-trigger time has passed.</td> </tr> <tr> <td>1</td> <td>Triggered</td> <td>1 = The user data logger has been triggered. The bit is cleared when the logger is restarted.</td> </tr> <tr> <td>2</td> <td>Data available</td> <td>1 = The user data logger contains data that can be read. Note that the bit is not cleared because the data is saved to the memory unit.</td> </tr> <tr> <td>3</td> <td>Configured</td> <td>1 = The user data logger has been configured. Note that the bit is not cleared because the configuration data is saved to the memory unit.</td> </tr> <tr> <td>4...15</td> <td>Reserved</td> <td></td> </tr> </tbody> </table> |                                       |  |              | Bit | Name | Description | 0 | Running | 1 = The user data logger is running. The bit is cleared after the post-trigger time has passed. | 1 | Triggered | 1 = The user data logger has been triggered. The bit is cleared when the logger is restarted. | 2 | Data available | 1 = The user data logger contains data that can be read. Note that the bit is not cleared because the data is saved to the memory unit. | 3 | Configured | 1 = The user data logger has been configured. Note that the bit is not cleared because the configuration data is saved to the memory unit. | 4...15 | Reserved |  |
| Bit  | Name                                  | Description  |              |     |      |             |   |         |   |   |           |   |   |                |   |   |            |  |        |          |  |
| 0  | Running                               | 1 = The user data logger is running. The bit is cleared after the post-trigger time has passed.  |              |     |      |             |   |         |   |   |           |   |   |                |   |   |            |  |        |          |  |
| 1  | Triggered                             | 1 = The user data logger has been triggered. The bit is cleared when the logger is restarted.  |              |     |      |             |   |         |   |   |           |   |   |                |   |   |            |  |        |          |  |
| 2  | Data available                        | 1 = The user data logger contains data that can be read. Note that the bit is not cleared because the data is saved to the memory unit.    |              |     |      |             |   |         |   |   |           |   |   |                |   |   |            |  |        |          |  |
| 3  | Configured                            | 1 = The user data logger has been configured. Note that the bit is not cleared because the configuration data is saved to the memory unit. |              |     |      |             |   |         |   |   |           |   |   |                |   |   |            |  |        |          |  |
| 4...15   | Reserved                              |  |              |     |      |             |   |         |   |   |           |   |   |                |   |   |            |  |        |          |  |
|  | 0000b...1111b                         | User data logger status word.  | 1 = 1        |     |      |             |   |         |   |   |           |   |   |                |   |   |            |  |        |          |  |
| 96.63  | <i>User data logger trigger</i>       | Triggers, or selects a source that triggers, the user data logger.   | <i>Off</i>   |     |      |             |   |         |   |   |           |   |   |                |   |   |            |  |        |          |  |
|  | Off                                   | 0.   | 0            |     |      |             |   |         |   |   |           |   |   |                |   |   |            |  |        |          |  |
|  | On                                    | 1.   | 1            |     |      |             |   |         |   |   |           |   |   |                |   |   |            |  |        |          |  |
|  | <i>Other [bit]</i>                    | Source selection (see <i>Terms and abbreviations</i> on page 112).   | -            |     |      |             |   |         |   |   |           |   |   |                |   |   |            |  |        |          |  |
| 96.64  | <i>User data logger start</i>         | Starts, or selects a source that starts, the user data logger.   | <i>Off</i>   |     |      |             |   |         |   |   |           |   |   |                |   |   |            |  |        |          |  |
|  | Off                                   | 0.   | 0            |     |      |             |   |         |   |   |           |   |   |                |   |   |            |  |        |          |  |
|  | On                                    | 1.   | 1            |     |      |             |   |         |   |   |           |   |   |                |   |   |            |  |        |          |  |
|  | <i>Other [bit]</i>                    | Source selection (see <i>Terms and abbreviations</i> on page 112).   | -            |     |      |             |   |         |   |   |           |   |   |                |   |   |            |  |        |          |  |
| 96.65  | <i>Factory data logger time level</i> | Selects the sampling interval for the factory data logger (see page 488).  | <i>500us</i> |     |      |             |   |         |   |   |           |   |   |                |   |   |            |  |        |          |  |
|  | 500us                                 | 500 microseconds.  | 500          |     |      |             |   |         |   |   |           |   |   |                |   |   |            |  |        |          |  |
|  | 2ms                                   | 2 milliseconds.  | 2000         |     |      |             |   |         |   |   |           |   |   |                |   |   |            |  |        |          |  |
|  | 10ms                                  | 10 milliseconds.   | 10000        |     |      |             |   |         |   |   |           |   |   |                |   |   |            |  |        |          |  |
| 96.70  | <i>Disable adaptive program</i>       | Enables/disables the adaptive program (if present). See also section <i>Adaptive programming</i> (page 27).                                | <i>No</i>    |     |      |             |   |         |   |   |           |   |   |                |   |   |            |  |        |          |  |
|  | No                                    | Adaptive program enabled.  | 0            |     |      |             |   |         |   |   |           |   |   |                |   |   |            |  |        |          |  |
|  | Yes                                   | Adaptive program disabled.   | 1            |     |      |             |   |         |   |   |           |   |   |                |   |   |            |  |        |          |  |

| No.    | Name/Value                    | Description   | Def/FbEq16 |
|--------|-------------------------------|---|------------|
| 96.100 | <i>Change user pass code</i>  | <i>(Visible when user lock is open)</i><br>To change the current user pass code, enter a new code into this parameter as well as <i>96.101 Confirm user pass code</i> . A warning will be active until the new pass code is confirmed. To cancel changing the pass code, close the user lock without confirming. To close the lock, enter an invalid pass code in parameter <i>96.02 Pass code</i> , activate parameter <i>96.08 Control board boot</i> , or cycle the power.<br>See also section <i>User lock</i> (page 91). | 10000000   |
|        | 10000000...<br>99999999       | New user pass code.   | -          |
| 96.101 | <i>Confirm user pass code</i> | <i>(Visible when user lock is open)</i><br>Confirms the new user pass code entered in <i>96.100 Change user pass code</i> .   |            |
|        | 10000000...<br>99999999       | Confirmation of new user pass code.   | -          |

| No.   | Name/Value                     | Description   | Def/FbEq16 |     |      |             |   |                           |   |   |                             |  |   |                       |   |   |                            |   |       |          |  |   |            |  |   |                         |   |        |          |  |    |                            |                                 |    |                            |                                 |    |                            |                                 |         |          |  |
|---|--------------------------------|---|------------|-----|------|-------------|---|---------------------------|---|---|-----------------------------|--|---|-----------------------|---|---|----------------------------|---|-------|----------|--|---|------------|--|---|-------------------------|---|--------|----------|--|----|----------------------------|---------------------------------|----|----------------------------|---------------------------------|----|----------------------------|---------------------------------|---------|----------|--|
| 96.102  | <i>User lock functionality</i> | <p>(Visible when user lock is open)</p> <p>Selects the actions or functionalities to be prevented by the user lock. Note that the changes made take effect only when the user lock is closed. See parameter <a href="#">96.02 Pass code</a>.</p> <p><b>Note:</b> We recommend you select all the actions and functionalities unless otherwise required by the application.</p>  | 0000h      |     |      |             |   |                           |   |   |                             |  |   |                       |   |   |                            |   |       |          |  |   |            |  |   |                         |   |        |          |  |    |                            |                                 |    |                            |                                 |    |                            |                                 |         |          |  |
| <table border="1"> <thead> <tr> <th>Bit</th> <th>Name</th> <th>Information</th> </tr> </thead> <tbody> <tr> <td>0</td> <td>Disable ABB access levels</td> <td>1 = ABB access levels (service, advanced programmer, etc.; see <a href="#">96.03</a>) disabled</td> </tr> <tr> <td>1</td> <td>Freeze parameter lock state</td> <td>1 = Changing the parameter lock state prevented, ie. pass code 358 has no effect</td> </tr> <tr> <td>2</td> <td>Disable file download</td> <td>1 = Loading of files to drive prevented. This applies to <ul style="list-style-type: none"> <li>firmware upgrades</li> <li>safety functions module (<i>FSO-xx</i>) configuration</li> <li>parameter restore</li> <li>loading an adaptive program</li> <li>loading and debugging an application program</li> <li>changing home view of control panel</li> <li>editing drive texts</li> <li>editing the favorite parameters list on control panel</li> <li>configuration settings made through control panel such as time/date formats and enabling/disabling clock display.</li> </ul> </td> </tr> <tr> <td>3</td> <td>Disable FB write to hidden</td> <td>1 = Access to parameters on disabled access levels from fieldbus prevented.</td> </tr> <tr> <td>4...5</td> <td>Reserved</td> <td></td> </tr> <tr> <td>6</td> <td>Protect AP</td> <td>1 = Creating a backup and restoring from a backup prevented.</td> </tr> <tr> <td>7</td> <td>Disable panel Bluetooth</td> <td>1 = Bluetooth disabled on ACS-AP-W control panel. If the drive is part of a panel bus, Bluetooth is disabled on all panels.</td> </tr> <tr> <td>8...10</td> <td>Reserved</td> <td></td> </tr> <tr> <td>11</td> <td>Disable OEM access level 1</td> <td>1 = OEM access level 1 disabled</td> </tr> <tr> <td>12</td> <td>Disable OEM access level 2</td> <td>1 = OEM access level 2 disabled</td> </tr> <tr> <td>13</td> <td>Disable OEM access level 3</td> <td>1 = OEM access level 3 disabled</td> </tr> <tr> <td>14...15</td> <td>Reserved</td> <td></td> </tr> </tbody> </table> |                                |   |            | Bit | Name | Information | 0 | Disable ABB access levels | 1 = ABB access levels (service, advanced programmer, etc.; see <a href="#">96.03</a> ) disabled | 1 | Freeze parameter lock state | 1 = Changing the parameter lock state prevented, ie. pass code 358 has no effect | 2 | Disable file download | 1 = Loading of files to drive prevented. This applies to <ul style="list-style-type: none"> <li>firmware upgrades</li> <li>safety functions module (<i>FSO-xx</i>) configuration</li> <li>parameter restore</li> <li>loading an adaptive program</li> <li>loading and debugging an application program</li> <li>changing home view of control panel</li> <li>editing drive texts</li> <li>editing the favorite parameters list on control panel</li> <li>configuration settings made through control panel such as time/date formats and enabling/disabling clock display.</li> </ul> | 3 | Disable FB write to hidden | 1 = Access to parameters on disabled access levels from fieldbus prevented. | 4...5 | Reserved |  | 6 | Protect AP | 1 = Creating a backup and restoring from a backup prevented. | 7 | Disable panel Bluetooth | 1 = Bluetooth disabled on ACS-AP-W control panel. If the drive is part of a panel bus, Bluetooth is disabled on all panels. | 8...10 | Reserved |  | 11 | Disable OEM access level 1 | 1 = OEM access level 1 disabled | 12 | Disable OEM access level 2 | 1 = OEM access level 2 disabled | 13 | Disable OEM access level 3 | 1 = OEM access level 3 disabled | 14...15 | Reserved |  |
| Bit   | Name                           | Information   |            |     |      |             |   |                           |   |   |                             |  |   |                       |   |   |                            |   |       |          |  |   |            |  |   |                         |   |        |          |  |    |                            |                                 |    |                            |                                 |    |                            |                                 |         |          |  |
| 0   | Disable ABB access levels      | 1 = ABB access levels (service, advanced programmer, etc.; see <a href="#">96.03</a> ) disabled   |            |     |      |             |   |                           |   |   |                             |  |   |                       |   |   |                            |   |       |          |  |   |            |  |   |                         |   |        |          |  |    |                            |                                 |    |                            |                                 |    |                            |                                 |         |          |  |
| 1   | Freeze parameter lock state    | 1 = Changing the parameter lock state prevented, ie. pass code 358 has no effect  |            |     |      |             |   |                           |   |   |                             |  |   |                       |   |   |                            |   |       |          |  |   |            |  |   |                         |   |        |          |  |    |                            |                                 |    |                            |                                 |    |                            |                                 |         |          |  |
| 2   | Disable file download          | 1 = Loading of files to drive prevented. This applies to <ul style="list-style-type: none"> <li>firmware upgrades</li> <li>safety functions module (<i>FSO-xx</i>) configuration</li> <li>parameter restore</li> <li>loading an adaptive program</li> <li>loading and debugging an application program</li> <li>changing home view of control panel</li> <li>editing drive texts</li> <li>editing the favorite parameters list on control panel</li> <li>configuration settings made through control panel such as time/date formats and enabling/disabling clock display.</li> </ul> |            |     |      |             |   |                           |   |   |                             |  |   |                       |   |   |                            |   |       |          |  |   |            |  |   |                         |   |        |          |  |    |                            |                                 |    |                            |                                 |    |                            |                                 |         |          |  |
| 3   | Disable FB write to hidden     | 1 = Access to parameters on disabled access levels from fieldbus prevented.   |            |     |      |             |   |                           |   |   |                             |  |   |                       |   |   |                            |   |       |          |  |   |            |  |   |                         |   |        |          |  |    |                            |                                 |    |                            |                                 |    |                            |                                 |         |          |  |
| 4...5   | Reserved                       |   |            |     |      |             |   |                           |   |   |                             |  |   |                       |   |   |                            |   |       |          |  |   |            |  |   |                         |   |        |          |  |    |                            |                                 |    |                            |                                 |    |                            |                                 |         |          |  |
| 6   | Protect AP                     | 1 = Creating a backup and restoring from a backup prevented.  |            |     |      |             |   |                           |   |   |                             |  |   |                       |   |   |                            |   |       |          |  |   |            |  |   |                         |   |        |          |  |    |                            |                                 |    |                            |                                 |    |                            |                                 |         |          |  |
| 7   | Disable panel Bluetooth        | 1 = Bluetooth disabled on ACS-AP-W control panel. If the drive is part of a panel bus, Bluetooth is disabled on all panels.   |            |     |      |             |   |                           |   |   |                             |  |   |                       |   |   |                            |   |       |          |  |   |            |  |   |                         |   |        |          |  |    |                            |                                 |    |                            |                                 |    |                            |                                 |         |          |  |
| 8...10  | Reserved                       |   |            |     |      |             |   |                           |   |   |                             |  |   |                       |   |   |                            |   |       |          |  |   |            |  |   |                         |   |        |          |  |    |                            |                                 |    |                            |                                 |    |                            |                                 |         |          |  |
| 11  | Disable OEM access level 1     | 1 = OEM access level 1 disabled   |            |     |      |             |   |                           |   |   |                             |  |   |                       |   |   |                            |   |       |          |  |   |            |  |   |                         |   |        |          |  |    |                            |                                 |    |                            |                                 |    |                            |                                 |         |          |  |
| 12  | Disable OEM access level 2     | 1 = OEM access level 2 disabled   |            |     |      |             |   |                           |   |   |                             |  |   |                       |   |   |                            |   |       |          |  |   |            |  |   |                         |   |        |          |  |    |                            |                                 |    |                            |                                 |    |                            |                                 |         |          |  |
| 13  | Disable OEM access level 3     | 1 = OEM access level 3 disabled   |            |     |      |             |   |                           |   |   |                             |  |   |                       |   |   |                            |   |       |          |  |   |            |  |   |                         |   |        |          |  |    |                            |                                 |    |                            |                                 |    |                            |                                 |         |          |  |
| 14...15   | Reserved                       |   |            |     |      |             |   |                           |   |   |                             |  |   |                       |   |   |                            |   |       |          |  |   |            |  |   |                         |   |        |          |  |    |                            |                                 |    |                            |                                 |    |                            |                                 |         |          |  |
|   | 0000h...FFFFh                  | Selection of actions to be prevented by user lock.  | -          |     |      |             |   |                           |   |   |                             |  |   |                       |   |   |                            |   |       |          |  |   |            |  |   |                         |   |        |          |  |    |                            |                                 |    |                            |                                 |    |                            |                                 |         |          |  |
| 96.108  | <i>LSU control board boot</i>  | <p>(Only visible when IGBT supply unit control activated by <a href="#">95.20</a>)</p> <p>Changing the value of this parameter to 1 reboots the supply control unit (without requiring a power off/on cycle of the drive system).</p> <p>The value reverts to 0 automatically.</p>  | 0          |     |      |             |   |                           |   |   |                             |  |   |                       |   |   |                            |   |       |          |  |   |            |  |   |                         |   |        |          |  |    |                            |                                 |    |                            |                                 |    |                            |                                 |         |          |  |
|   | 0...1                          | 1 = Reboot the supply control unit.   | 1 = 1      |     |      |             |   |                           |   |   |                             |  |   |                       |   |   |                            |   |       |          |  |   |            |  |   |                         |   |        |          |  |    |                            |                                 |    |                            |                                 |    |                            |                                 |         |          |  |



| No.                     | Name/Value                           | Description   | Def/FbEq16      |
|-------------------------|--------------------------------------|---|-----------------|
| <b>97 Motor control</b> |                                      | Motor model settings.   |                 |
| 97.01                   | <i>Switching frequency reference</i> | Defines the switching frequency when it is not otherwise being internally limited.<br><b>Note:</b> This is an expert level parameter and should not be adjusted without appropriate skill.  | 4.500 kHz       |
|                         | 0.000 ... 24.000 kHz                 | Switching frequency reference.  | 1000 = 1 kHz    |
| 97.02                   | <i>Minimum switching frequency</i>   | Defines a minimum switching frequency reference. The actual switching frequency will not fall below this limit under any circumstances.<br><b>Notes:</b> <ul style="list-style-type: none"> <li>This is an expert level parameter and should not be adjusted without appropriate skill.</li> <li>The drive has internal switching frequency limits that may override the value entered here.</li> </ul>   | 1.500 kHz       |
|                         | 0.000 ... 24.000 kHz                 | Minimum switching frequency.  | 1000 = 1 kHz    |
| 97.03                   | <i>Slip gain</i>                     | Defines the slip gain which is used to improve the estimated motor slip. 100% means full slip gain; 0% means no slip gain. The default value is 100%. Other values can be used if a static speed error is detected despite having the setting at full slip gain.<br><b>Example</b> (with nominal load and nominal slip of 40 rpm): A 1000 rpm constant speed reference is given to the drive. Despite having full slip gain (= 100%), a manual tachometer measurement from the motor axis gives a speed value of 998 rpm. The static speed error is 1000 rpm - 998 rpm = 2 rpm. To compensate the error, the slip gain should be increased to 105% (2 rpm / 40 rpm = 5%). | 100%            |
|                         | 0 ... 200%                           | Slip gain.  | 1 = 1%          |
| 97.04                   | <i>Voltage reserve</i>               | Defines the minimum allowed voltage reserve. When the voltage reserve has decreased to the set value, the drive enters the field weakening area.<br><b>Note:</b> This is an expert level parameter and should not be adjusted without appropriate skill.<br>If the intermediate circuit DC voltage $U_{dc} = 550$ V and the voltage reserve is 5%, the rms value of the maximum output voltage in steady-state operation is $0.95 \times 550$ V / $\sqrt{2} = 369$ V<br>The dynamic performance of the motor control in the field weakening area can be improved by increasing the voltage reserve value, but the drive enters the field weakening area earlier.          | -2%             |
|                         | -4 ... 50%                           | Voltage reserve.  | 1 = 1%          |
| 97.05                   | <i>Flux braking</i>                  | Defines the level of flux braking power. (Other stopping and braking modes can be configured in parameter group <a href="#">21 Start/stop mode</a> ).<br>See section <a href="#">Flux braking</a> (page 62).<br><b>Note:</b> This is an expert level parameter and should not be adjusted without appropriate skill.  | <i>Disabled</i> |
|                         | Disabled                             | Flux braking is disabled.   | 0               |
|                         | Moderate                             | Flux level is limited during the braking. Deceleration time is longer compared to full braking.   | 1               |

| No.   | Name/Value                      | Description   | Def/FbEq16                 |
|-------|---------------------------------|---|----------------------------|
|       | Full                            | Maximum braking power. Almost all available current is used to convert the mechanical braking energy to thermal energy in the motor.  | 2                          |
| 97.06 | <i>Flux reference select</i>    | Defines the source of flux reference.<br><b>Note:</b> This is an expert level parameter and should not be adjusted without appropriate skill.   | <i>User flux reference</i> |
|       | Zero                            | None.   | 0                          |
|       | User flux reference             | Parameter <i>97.07 User flux reference</i> .  | 1                          |
|       | <i>Other</i>                    | Source selection (see <i>Terms and abbreviations</i> on page 112).  | -                          |
| 97.07 | <i>User flux reference</i>      | Defines the flux reference when parameter <i>97.06 Flux reference select</i> is set to <i>User flux reference</i> .   | 100.00%                    |
|       | 0.00 ... 200.00%                | User-defined flux reference.  | 100 = 1%                   |
| 97.08 | <i>Optimizer minimum torque</i> | This parameter can be used to improve the control dynamics of a synchronous reluctance motor or a salient permanent magnet synchronous motor.<br>As a rule of thumb, define a level to which the output torque must rise with minimum delay. This will increase the motor current and improve the torque response at low speeds.  | 0.0%                       |
|       | 0.0 ... 1600.0%                 | Optimizer torque limit.   | 10 = 1%                    |
| 97.09 | <i>Switching freq mode</i>      | An optimization setting for balancing between control performance and motor noise level.<br><b>Note:</b> This is an expert level parameter and should not be adjusted without appropriate skill.  | <i>Normal</i>              |
|       | Normal                          | Control performance optimized for long motor cables.  | 0                          |
|       | Low noise                       | Minimizes motor noise.<br><b>Note:</b> This setting requires derating. Refer to the rating data in the <i>Hardware manual</i> .   | 1                          |
|       | Cyclic                          | Control performance optimized for cyclic load applications.<br><b>Note:</b> This setting is not suitable for long motor cables.   | 2                          |
|       | Custom                          | This setting is to be used by ABB-authorized service personnel only.<br><b>Note:</b> This setting may require derating. Refer to the rating data in the <i>Hardware manual</i> .  | 3                          |
| 97.10 | <i>Signal injection</i>         | Enables signal injection. A high-frequency alternating signal is injected into the motor at low speeds to improve the stability of torque control. Signal injection can be enabled with different amplitude levels.<br><b>Notes:</b> <ul style="list-style-type: none"> <li>This is an expert level parameter and should not be adjusted without appropriate skill.</li> <li>Use as low a level as possible that gives satisfactory performance.</li> <li>Signal injection cannot be applied to asynchronous motors.</li> </ul> | <i>Disabled</i>            |
|       | Disabled                        | Signal injection disabled.  | 0                          |
|       | Enabled (5 %)                   | Signal injection enabled with an amplitude level of 5%.   | 1                          |
|       | Enabled (10 %)                  | Signal injection enabled with an amplitude level of 10%.  | 2                          |
|       | Enabled (15 %)                  | Signal injection enabled with an amplitude level of 15%.  | 3                          |
|       | Enabled (20 %)                  | Signal injection enabled with an amplitude level of 20%.  | 4                          |

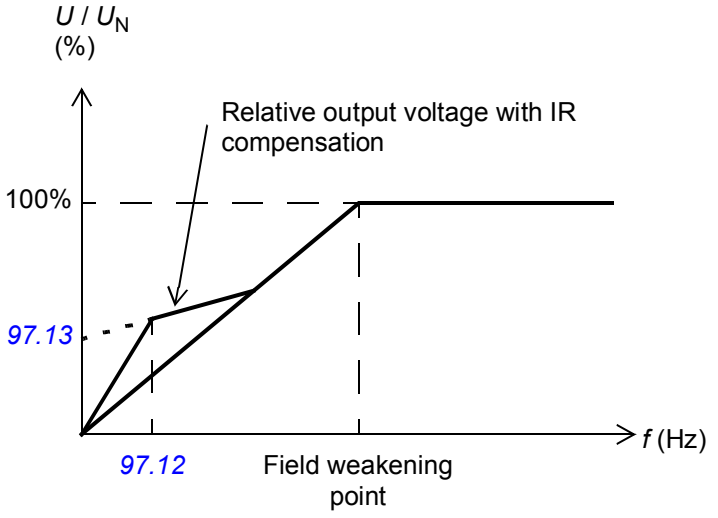
| No.             | Name/Value                       | Description  | Def/FbEq16 |
|-----------------|----------------------------------|--|------------|
| 97.11           | <i>TR tuning</i>                 | Rotor time constant tuning.<br>This parameter can be used to improve torque accuracy in closed-loop control of an induction motor. Normally, the motor identification run provides sufficient torque accuracy, but manual fine-tuning can be applied in exceptionally demanding applications to achieve optimal performance.<br><b>Note:</b> This is an expert level parameter and should not be adjusted without appropriate skill. | 100%       |
| 25...400%       |                                  | Rotor time constant tuning.  | 1 = 1%     |
| 97.12           | <i>IR comp step-up frequency</i> | IR compensation (ie. output voltage boost) can be used in step-up applications to compensate for resistive losses in the step-up transformer, cabling and motor. As voltage cannot be fed through a step-up transformer at 0 Hz, a specific type of IR compensation should be used.<br>This parameter adds a frequency breakpoint for parameter <a href="#">97.13 IR compensation</a> as shown below.                                | 0.0 Hz     |
|                 |                                  |  <p style="text-align: center;">0.0 Hz = Breakpoint disabled.</p>   |            |
| 0.0 ... 50.0 Hz |                                  | IR compensation breakpoint for step-up applications.   | 1 = 1 Hz   |

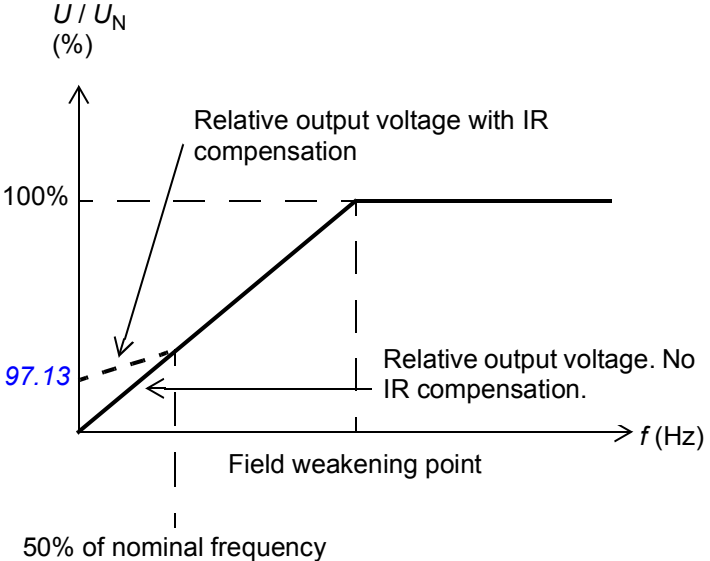
| No.   | Name/Value                                | Description   | Def/FbEq16      |
|-------|---|---|-----------------|
| 97.13 | <i>IR compensation</i>                    | <p>Defines the relative output voltage boost at zero speed (IR compensation). The function is useful in applications with a high break-away torque where direct torque control (DTC mode) cannot be applied.</p>  <p>See also section <i>IR compensation for scalar motor control</i> on page 58.</p> | 0.00%           |
|       | 0.00 ... 50.00%                           | Voltage boost at zero speed in percent of nominal motor voltage.  | 1 = 1%          |
| 97.15 | <i>Motor model temperature adaptation</i> | <p>Selects whether the temperature-dependent parameters (such as stator or rotor resistance) of the motor model adapt to actual (measured or estimated) temperature or not. See parameter group 35 <i>Motor thermal protection</i> for selection of temperature measurement sources.</p>  | <i>Disabled</i> |
|       | Disabled                                  | Temperature adaptation of motor model disabled.   | 0               |
|       | Estimated temperature                     | Estimated temperature ( <i>35.01 Motor estimated temperature</i> ) used for adaptation of motor model.  | 1               |
|       | Measured temperature 1                    | Measured temperature 1 ( <i>35.02 Measured temperature 1</i> ) used for adaptation of motor model.  | 2               |
|       | Measured temperature 2                    | Measured temperature 2 ( <i>35.03 Measured temperature 2</i> ) used for adaptation of motor model.  | 3               |
| 97.18 | <i>Hexagonal field weakening</i>          | <p>Activates hexagonal motor flux pattern in the field weakening area, ie. above the limit defined by parameter 97.19 <i>Hexagonal field weakening point</i>.<br/> <b>Note:</b> This parameter is only effective in scalar motor control mode.<br/>                     See also section <i>Hexagonal motor flux pattern</i> (page 65).</p>   | <i>Off</i>      |
|       | Off                                       | The rotating flux vector follows a circular pattern.  | 0               |
|       | On  | The flux vector follows a circular pattern below, and a hexagonal pattern above, the hexagonal field weakening point ( <i>97.19</i> ).  | 1               |

| No.                             | Name/Value                             | Description   | Def/FbEq16                     |
|---------------------------------|--|---|--------------------------------|
| 97.19                           | <i>Hexagonal field weakening point</i> | Defines the activation limit for hexagonal field weakening (in percent of the field weakening point, ie. the frequency at which maximum output voltage is reached). See parameter <a href="#">97.18 Hexagonal field weakening</a> .<br><b>Note:</b> This parameter is only effective in scalar motor control mode.  | 120.0%                         |
|                                 | 0.0 ... 500.0%                         | Activation limit for hexagonal field weakening.   | 1 = 1%                         |
| 97.32                           | <i>Motor torque unfiltered</i>         | Unfiltered motor torque in percent of the nominal motor torque.   | -                              |
|                                 | -1600.0 ... 1600.0%                    | Unfiltered motor torque.  | See par. <a href="#">46.03</a> |
| 97.33                           | <i>Speed estimate filter time</i>      | Defines a filtering time for estimated speed. See the diagram on page <a href="#">567</a> .   | 5.00 ms                        |
|                                 | 0.00 ... 100.00 ms                     | Filtering time for estimated speed.   | 1 = 1 ms                       |
| <b>98 User motor parameters</b> |  | Motor values supplied by the user that are used in the motor model.<br>These parameters are useful for non-standard motors, or to just get more accurate motor control of the motor on site. A better motor model always improves the shaft performance.  |                                |
| 98.01                           | <i>User motor model mode</i>           | Activates the motor model parameters <a href="#">98.02...98.14</a> and the rotor angle offset parameter <a href="#">98.15</a> .<br><b>Notes:</b> <ul style="list-style-type: none"> <li>Parameter value is automatically set to zero when ID run is selected by parameter <a href="#">99.13 ID run requested</a>. The values of parameters <a href="#">98.02...98.15</a> are then updated according to the motor characteristics identified during the ID run.</li> <li>Measurements made directly from the motor terminals during the ID run are likely to produce slightly different values than those on a datasheet from a motor manufacturer.</li> <li>This parameter cannot be changed while the drive is running.</li> </ul> | <i>Not selected</i>            |
|                                 | Not selected                           | Parameters <a href="#">98.02...98.15</a> inactive.  | 0                              |
|                                 | Motor parameters                       | The values of parameters <a href="#">98.02...98.14</a> are used as the motor model.   | 1                              |
|                                 | Position offset                        | The value of parameter <a href="#">98.15</a> is used as the rotor angle offset. Parameters <a href="#">98.02...98.14</a> are inactive.  | 2                              |
|                                 | Motor parameters & position offset     | The values of parameters <a href="#">98.02...98.14</a> are used as the motor model, and the value of parameter <a href="#">98.15</a> is used as the rotor angle offset.   | 3                              |
| 98.02                           | <i>Rs user</i>                         | Defines the stator resistance $R_S$ of the motor model. With a star-connected motor, $R_S$ is the resistance of one winding. With a delta-connected motor, $R_S$ is one-third of the resistance of one winding.   | 0.00000 p.u.                   |
|                                 | 0.00000 ... 0.50000 p.u.               | Stator resistance in per unit.  | -                              |
| 98.03                           | <i>Rr user</i>                         | Defines the rotor resistance $R_R$ of the motor model.<br><b>Note:</b> This parameter is valid only for asynchronous motors.  | 0.00000 p.u.                   |
|                                 | 0.00000 ... 0.50000 p.u.               | Rotor resistance in per unit.   | -                              |

## 422 Parameters

| No.   | Name/Value                   | Description   | Def/FbEq16   |
|-------|------------------------------|---|--------------|
| 98.04 | <i>Lm user</i>               | Defines the main inductance $L_M$ of the motor model.<br><b>Note:</b> This parameter is valid only for asynchronous motors.     | 0.00000 p.u. |
|       | 0.00000 ...<br>10.00000 p.u. | Main inductance in per unit.  | -            |
| 98.05 | <i>SigmaL user</i>           | Defines the leakage inductance $\sigma L_S$ .<br><b>Note:</b> This parameter is valid only for asynchronous motors.             | 0.00000 p.u. |
|       | 0.00000 ... 1.00000<br>p.u.  | Leakage inductance in per unit.   | -            |
| 98.06 | <i>Ld user</i>               | Defines the direct axis (synchronous) inductance.<br><b>Note:</b> This parameter is valid only for permanent magnet motors.     | 0.00000 p.u. |
|       | 0.00000 ...<br>10.00000 p.u  | Direct axis inductance in per unit.   | -            |
| 98.07 | <i>Lq user</i>               | Defines the quadrature axis (synchronous) inductance.<br><b>Note:</b> This parameter is valid only for permanent magnet motors. | 0.00000 p.u. |
|       | 0.00000 ...<br>10.00000 p.u  | Quadrature axis inductance in per unit.   | -            |
| 98.08 | <i>PM flux user</i>          | Defines the permanent magnet flux.<br><b>Note:</b> This parameter is valid only for permanent magnet motors.                    | 0.00000 p.u. |
|       | 0.00000 ... 2.00000<br>p.u   | Permanent magnet flux in per unit.  | -            |
| 98.09 | <i>Rs user SI</i>            | Defines the stator resistance $R_S$ of the motor model.   | 0.00000 ohm  |
|       | 0.00000 ...<br>100.00000 ohm | Stator resistance.  | -            |
| 98.10 | <i>Rr user SI</i>            | Defines the rotor resistance $R_R$ of the motor model.<br><b>Note:</b> This parameter is valid only for asynchronous motors.    | 0.00000 ohm  |
|       | 0.00000 ...<br>100.00000 ohm | Rotor resistance.   | -            |
| 98.11 | <i>Lm user SI</i>            | Defines the main inductance $L_M$ of the motor model.<br><b>Note:</b> This parameter is valid only for asynchronous motors.     | 0.00 mH      |
|       | 0.00 ...100000.00<br>mH      | Main inductance.  | 1 = 10 mH    |
| 98.12 | <i>SigmaL user SI</i>        | Defines the leakage inductance $\sigma L_S$ .<br><b>Note:</b> This parameter is valid only for asynchronous motors.             | 0.00 mH      |
|       | 0.00 ...100000.00<br>mH      | Leakage inductance.   | 1 = 10 mH    |
| 98.13 | <i>Ld user SI</i>            | Defines the direct axis (synchronous) inductance.<br><b>Note:</b> This parameter is valid only for permanent magnet motors.     | 0.00 mH      |
|       | 0.00 ...100000.00<br>mH      | Direct axis inductance.   | 1 = 10 mH    |
| 98.14 | <i>Lq user SI</i>            | Defines the quadrature axis (synchronous) inductance.<br><b>Note:</b> This parameter is valid only for permanent magnet motors. | 0.00 mH      |
|       | 0.00 ...100000.00<br>mH      | Quadrature axis inductance.   | 1 = 10 mH    |

| No.                  | Name/Value                  | Description  | Def/FbEq16   |
|----------------------|-----------------------------|--|--|
| 98.15                | <i>Position offset user</i> | <p>Defines an angle offset between the zero position of the synchronous motor and the zero position of the position sensor.</p> <p>This value is initially set by the autophasing routine when parameter <a href="#">21.13 Autophasing mode</a> is set to <i>Turning with Z-pulse</i>, and can be fine-tuned later on.</p> <p><b>Notes:</b></p> <ul style="list-style-type: none"> <li>The value is in electrical degrees. The electrical angle equals the mechanical angle multiplied by the number of motor pole pairs.</li> <li>This parameter is valid only for permanent magnet motors.</li> </ul>  | 0 deg  |
|                      | 0...360 deg                 | Angle offset.  | 1 = 1 deg  |
| <b>99 Motor data</b> |                             | Motor configuration settings.  |  |
| 99.03                | <i>Motor type</i>           | <p>Selects the motor type.</p> <p><b>Note:</b> This parameter cannot be changed while the drive is running.</p>  | <i>Asynchronous motor;</i><br><i>SynRM</i><br><i>(95.21 b1);</i><br><i>Permanent magnet motor</i><br><i>(95.21 b2)</i> |
|                      | Asynchronous motor          | Standard squirrel cage AC induction motor (asynchronous induction motor).  | 0  |
|                      | Permanent magnet motor      | Permanent magnet motor. Three-phase AC synchronous motor with permanent magnet rotor and sinusoidal BackEMF voltage.   | 1  |
|                      | SynRM                       | Synchronous reluctance motor. Three-phase AC synchronous motor with salient pole rotor without permanent magnets.  | 2  |
| 99.04                | <i>Motor control mode</i>   | Selects the motor control mode.  | <i>DTC</i>   |
|                      | DTC                         | <p>Direct torque control. This mode is suitable for most applications.</p> <p><b>Note:</b> Instead of direct torque control, scalar control is also available, and should be used in the following situations:</p> <ul style="list-style-type: none"> <li>with multimotor applications 1) if the load is not equally shared between the motors, 2) if the motors are of different sizes, or 3) if the motors are going to be changed after the motor identification (ID run)</li> <li>if the nominal current of the motor is less than 1/6 of the nominal output current of the drive</li> <li>if the drive is used with no motor connected (for example, for test purposes).</li> </ul> <p>See also section <a href="#">Operating modes of the drive</a> (page 22).</p> | 0  |
|                      | Scalar                      | <p>Scalar control. The outstanding motor control accuracy of DTC cannot be achieved in scalar control.</p> <p>Refer to the <i>DTC</i> selection above for a list of applications where scalar control should definitely be used.</p> <p><b>Notes:</b></p> <ul style="list-style-type: none"> <li>Correct motor operation requires that the magnetizing current of the motor does not exceed 90% of the nominal current of the inverter.</li> <li>Some standard features are disabled in scalar control mode.</li> </ul> <p>See also section <a href="#">Scalar motor control</a> (page 58), and section <a href="#">Operating modes of the drive</a> (page 22).</p>  | 1  |

| No.   | Name/Value                                      | Description  | Def/FbEq16    |
|-------|---|--|---------------|
| 99.06 | <i>Motor nominal current</i>                    | Defines the nominal motor current. This setting must match the value on the rating plate of the motor. If multiple motors are connected to the drive, enter the total current of the motors.<br><b>Notes:</b> <ul style="list-style-type: none"> <li>Correct motor operation requires that the magnetizing current of the motor does not exceed 90% of the nominal current of the drive.</li> <li>This parameter cannot be changed while the drive is running.</li> </ul>  | 0.0 A         |
|       | 0.0 ... 6400.0 A                                | Nominal current of the motor. The allowable range is $1/6...2 \times I_N$ (nominal current) of the drive ( $0...2 \times I_N$ with scalar control mode).   | 1 = 1 A       |
| 99.07 | <i>Motor nominal voltage</i>                    | Defines the nominal motor voltage supplied to the motor. This setting must match the value on the rating plate of the motor.<br><b>Notes:</b> <ul style="list-style-type: none"> <li>With permanent magnet motors, the nominal voltage is the BackEMF voltage at nominal speed of the motor. If the voltage is given as voltage per rpm, e.g. 60 V per 1000 rpm, the voltage for a nominal speed of 3000 rpm is <math>3 \times 60 \text{ V} = 180 \text{ V}</math>.</li> <li>The stress on the motor insulation is always dependent on the drive supply voltage. This also applies to the case where the motor voltage rating is lower than that of the drive and the supply.</li> <li>This parameter cannot be changed while the drive is running.</li> </ul> | 0.0 V         |
|       | 0.0 ... 800.0 V                                 | Nominal voltage of the motor. The allowable range is $1/6...2 \times U_N$ (nominal voltage) of the drive. $U_N$ equals the upper bound of the supply voltage range selected by parameter <a href="#">95.01 Supply voltage</a> .  | 10 = 1 V      |
| 99.08 | <i>Motor nominal frequency</i>                  | Defines the nominal motor frequency. This setting must match the value on the rating plate of the motor.<br><b>Note:</b> This parameter cannot be changed while the drive is running.  | 50.00 Hz      |
|       | 0.00 ... 1000.00 Hz                             | Nominal frequency of the motor.  | 10 = 1 Hz     |
| 99.09 | <i>Motor nominal speed</i>                      | Defines the nominal motor speed. The setting must match the value on the rating plate of the motor.<br><b>Note:</b> This parameter cannot be changed while the drive is running.   | 0 rpm         |
|       | 0 ... 30000 rpm                                 | Nominal speed of the motor.  | 1 = 1 rpm     |
| 99.10 | <i>Motor nominal power</i>                      | Defines the nominal motor power. The setting must match the value on the rating plate of the motor. If nominal power is not shown on the rating plate, nominal torque can be entered instead in parameter <a href="#">99.12</a> .<br>If multiple motors are connected to the drive, enter the total power of the motors.<br>The unit is selected by parameter <a href="#">96.16 Unit selection</a> .<br><b>Note:</b> This parameter cannot be changed while the drive is running.  | 0.00 kW or hp |
|       | 0.00 ... 10000.00 kW or<br>0.00 ... 13404.83 hp | Nominal power of the motor.  | 1 = 1 unit    |



| No.   | Name/Value                               | Description   | Def/FbEq16            |
|-------|--|---|-----------------------|
| 99.11 | <i>Motor nominal cos ?</i>               | Defines the cosphi of the motor for a more accurate motor model. The value is not obligatory, but is useful with an asynchronous motor, especially when performing a standstill identification run. With a permanent magnet or synchronous reluctance motor, this value is not needed.<br><b>Notes:</b> <ul style="list-style-type: none"> <li>• Do not enter an estimated value. If you do not know the exact value, leave the parameter at zero.</li> <li>• This parameter cannot be changed while the drive is running.</li> </ul> | 0.00                  |
|       | 0.00 ... 1.00                            | Cosphi of the motor.  | 100 = 1               |
| 99.12 | <i>Motor nominal torque</i>              | Defines the nominal motor shaft torque. This value can be given instead of nominal power (99.10) if shown on the rating plate of the motor.<br>The unit is selected by parameter 96.16 <i>Unit selection</i> .<br><b>Notes:</b> <ul style="list-style-type: none"> <li>• This setting is an alternative to the nominal power value (99.10). If both are entered, 99.12 takes priority.</li> <li>• This parameter cannot be changed while the drive is running.</li> </ul>   | 0.000<br>N·m or lb·ft |
|       | 0.000 ...<br>4000000.000<br>N·m or lb·ft | Nominal motor torque.   | 1 = 1 unit            |

| No.   | Name/Value              | Description  | Def/FbEq16   |
|-------|-------------------------|--|--|
| 99.13 | <i>ID run requested</i> | <p>Selects the type of the motor identification routine (ID run) performed at the next start of the drive. During the ID run, the drive will identify the characteristics of the motor for optimum motor control.</p> <p>If no ID run has been performed yet (or if default parameter values have been restored using parameter <a href="#">96.06 Parameter restore</a>), this parameter is automatically set to <i>Standstill</i>, signifying that an ID run must be performed.</p> <p>After the ID run, the drive stops and this parameter is automatically set to <i>None</i>.</p> <p><b>Notes:</b></p> <ul style="list-style-type: none"> <li>For the <i>Advanced</i> ID run, the machinery must always be de-coupled from the motor.</li> <li>Before activating the ID run, configure motor temperature measurement (if used) in parameter group <a href="#">35 Motor thermal protection</a>, and in parameter <a href="#">97.15</a>.</li> <li>If a sine filter is installed, set the appropriate bit in parameter <a href="#">95.15 Special HW settings</a> before activating the ID run. With a non-ABB (custom) filter, set also <a href="#">99.18</a> and <a href="#">99.19</a>.</li> <li>With scalar control mode (<a href="#">99.04 Motor control mode</a> = <i>Scalar</i>), the ID run is not requested automatically. However, an ID run can be performed for more accurate torque estimation.</li> <li>Once the ID run is activated, it can be canceled by stopping the drive.</li> <li>The ID run must be performed every time any of the motor parameters (<a href="#">99.04</a>, <a href="#">99.06</a>...<a href="#">99.12</a>) have been changed.</li> <li>Ensure that the Safe torque off and emergency stop circuits (if any) are closed during the ID run.</li> <li>Mechanical brake (if present) is not opened by the logic for the ID run.</li> <li>This parameter cannot be changed while the drive is running.</li> </ul> | <i>None</i> ;<br><i>Standstill</i><br>( <a href="#">95.21</a> b1/b2) |
|       | None                    | No motor ID run is requested. This mode can be selected only if the ID run ( <i>Normal</i> , <i>Reduced</i> , <i>Standstill</i> , <i>Advanced</i> , <i>Advanced Standstill</i> ) has already been performed once.  | 0  |
|       | Normal                  | <p>Normal ID run. Guarantees good control accuracy for all cases. The ID run takes about 90 seconds. This mode should be selected whenever it is possible.</p> <p><b>Notes:</b></p> <ul style="list-style-type: none"> <li>If the load torque will be higher than 20% of motor nominal torque, or if the machinery is not able to withstand the nominal torque transient during the ID run, then the driven machinery must be de-coupled from the motor during a Normal ID run.</li> <li>Check the direction of rotation of the motor before starting the ID run. During the run, the motor will rotate in the forward direction.</li> </ul> <p> <b>WARNING!</b> The motor will run at up to approximately 50...100% of the nominal speed during the ID run. ENSURE THAT IT IS SAFE TO RUN THE MOTOR BEFORE PERFORMING THE ID RUN!</p>  | 1  |

| No. | Name/Value                      | Description   | Def/FbEq16 |
|-----|---------------------------------|---|------------|
|     | Reduced                         | <p>Reduced ID run. This mode should be selected instead of the <i>Normal</i> or <i>Advanced</i> ID Run if</p> <ul style="list-style-type: none"> <li>• mechanical losses are higher than 20% (i.e. the motor cannot be de-coupled from the driven equipment), or if</li> <li>• flux reduction is not allowed while the motor is running (i.e. in case of a motor with an integrated brake supplied from the motor terminals).</li> </ul> <p>With this ID run mode, the resultant motor control in the field weakening area or at high torques is not necessarily as accurate as motor control following a Normal ID Run. Reduced ID run is completed faster than the Normal ID Run (&lt; 90 seconds).</p> <p><b>Note:</b> Check the direction of rotation of the motor before starting the ID run. During the run, the motor will rotate in the forward direction.</p> <p> <b>WARNING!</b> The motor will run at up to approximately 50...100% of the nominal speed during the ID run. ENSURE THAT IT IS SAFE TO RUN THE MOTOR BEFORE PERFORMING THE ID RUN!</p> | 2          |
|     | Standstill                      | <p>Standstill ID run. The motor is injected with DC current. With an AC induction (asynchronous) motor, the motor shaft is not rotated. With a permanent magnet motor or synchronous reluctance motor, the shaft can rotate up to half a revolution.</p> <p><b>Note:</b> A standstill ID run should be selected only if the <i>Normal</i>, <i>Reduced</i> or <i>Advanced</i> ID run is not possible due to the restrictions caused by the connected mechanics (eg. with lift or crane applications).</p> <p>See also selection <i>Advanced Standstill</i>.</p>  | 3          |
|     | Autophasing                     | <p>The autophasing routine determines the start angle of a permanent magnet or synchronous reluctance motor (see page 59). Autophasing does not update the other motor model values.</p> <p>Autophasing is automatically performed as part of the <i>Normal</i>, <i>Reduced</i>, <i>Standstill</i>, <i>Advanced</i> or <i>Advanced Standstill</i> ID runs. Using this setting, it is possible to perform autophasing alone. This is useful after changes in the feedback configuration, such as the replacement or addition of an absolute encoder, resolver, or pulse encoder with commutation signals.</p> <p><b>Notes:</b></p> <ul style="list-style-type: none"> <li>• This setting can only be used after a <i>Normal</i>, <i>Reduced</i>, <i>Standstill</i>, <i>Advanced</i> or <i>Advanced Standstill</i> ID run has already been performed.</li> <li>• Depending on the selected autophasing mode, the shaft can rotate during autophasing. See parameter <i>21.13 Autophasing mode</i>.</li> </ul>   | 4          |
|     | Current measurement calibration | <p>Requests current measurement calibration, ie. identification of current measurement offset and gain errors.</p> <p>The calibration will be performed at next start.</p>  | 5          |

| No.   | Name/Value                        | Description  | Def/FbEq16   |
|-------|-----------------------------------|--|--------------|
|       | Advanced                          | Advanced ID run. Guarantees the best possible control accuracy. The ID run can take a couple of minutes. This mode should be selected when top performance is needed across the whole operating area.<br><b>Note:</b> The driven machinery must be de-coupled from the motor because of high torque and speed transients that are applied.<br> <b>WARNING!</b> The motor will run at up to approximately 50...100% of the nominal speed during the ID run. Several accelerations and decelerations are done. ENSURE THAT IT IS SAFE TO RUN THE MOTOR BEFORE PERFORMING THE ID RUN!  | 6            |
|       | Advanced Standstill               | Advanced Standstill ID run.<br>This selection is recommended with AC induction motors up to 75 kW instead of the <i>Standstill</i> ID run if <ul style="list-style-type: none"> <li>the exact nominal ratings of the motor are not known, or</li> <li>the control performance of the motor is not satisfactory after a <i>Standstill</i> ID run.</li> </ul> <b>Note:</b> The time it takes for the <i>Advanced Standstill</i> ID run to complete varies according to motor size. With a small motor, the ID run typically completes within 5 minutes; with a large motor, the ID run may take up to an hour.   | 7            |
| 99.14 | <i>Last ID run performed</i>      | Shows the type of ID run that was performed last. For more information about the different modes, see the selections of parameter <i>99.13 ID run requested</i> .  | <i>None</i>  |
|       | None                              | No ID run has been performed.  | 0            |
|       | Normal                            | <i>Normal</i> ID run.  | 1            |
|       | Reduced                           | <i>Reduced</i> ID run.   | 2            |
|       | Standstill                        | <i>Standstill</i> ID run.  | 3            |
|       | Advanced                          | <i>Advanced</i> ID run.  | 6            |
|       | Advanced Standstill               | <i>Advanced Standstill</i> ID run.   | 7            |
| 99.15 | <i>Motor polepairs calculated</i> | Calculated number of pole pairs in the motor.  | 0            |
|       | 0...1000                          | Number of pole pairs.  | 1 = 1        |
| 99.16 | <i>Motor phase order</i>          | Switches the rotation direction of motor. This parameter can be used if the motor turns in the wrong direction (for example, because of the wrong phase order in the motor cable), and correcting the cabling is considered impractical.<br><b>Notes:</b> <ul style="list-style-type: none"> <li>Changing this parameter does not affect speed reference polarities, so positive speed reference will rotate the motor forward. The phase order selection just ensures that "forward" is in fact the correct direction.</li> <li>After changing this parameter, the sign of encoder feedback (if any) must be checked. This can be done by setting parameter <i>90.41 Motor feedback selection</i> to <i>Estimate</i>, and comparing the sign of <i>90.01 Motor speed for control</i> to <i>90.10 Encoder 1 speed</i> (or <i>90.20 Encoder 2 speed</i>). If the sign of the measurement is incorrect, the encoder wiring must be corrected or the sign of <i>90.43 Motor gear numerator</i> reversed.</li> </ul> | <i>U V W</i> |
|       | U V W                             | Normal.  | 0            |
|       | U W V                             | Reversed rotation direction.   | 1            |

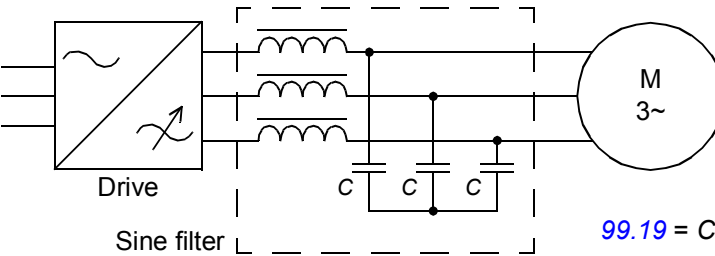
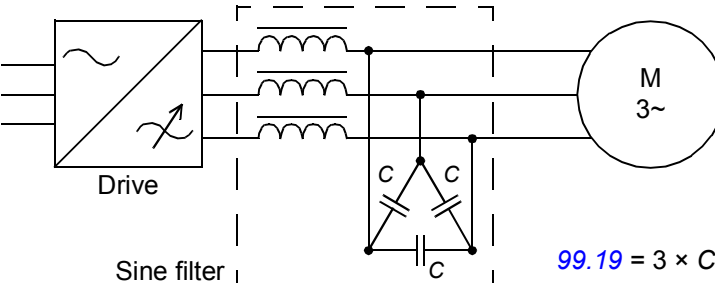
| No.   | Name/Value                 | Description   | Def/FbEq16      |
|-------|----------------------------|---|-----------------|
| 99.18 | Sine filter inductance     | Defines the inductance of a custom sine filter, ie. when parameter <a href="#">95.15 Special HW settings</a> bit 3 is activated.<br><b>Note:</b> For an ABB sine filter ( <a href="#">95.15 Special HW settings</a> bit 1), this parameter is set automatically and should not be adjusted. | -               |
|       | 0.000 ... 100000.000 mH    | Inductance of custom sine filter.   | 1000 = 1 mH     |
| 99.19 | Sine filter capacitance    | Defines the capacitance of a custom sine filter, ie. when parameter <a href="#">95.15 Special HW settings</a> bit 3 is activated. If the capacitors are star/gye-connected, enter the capacitance of <u>one leg</u> into the parameter.   | -               |
|       |                            |  <p style="text-align: right;"><b>99.19 = C</b></p>   |                 |
|       |                            | If the capacitors are delta-connected, multiply the capacitance of <u>one leg</u> by 3 and enter the result into the parameter.   |                 |
|       |                            |  <p style="text-align: right;"><b>99.19 = 3 × C</b></p>  |                 |
|       |                            | <b>Note:</b> For an ABB sine filter ( <a href="#">95.15 Special HW settings</a> bit 1), this parameter is set automatically and should not be adjusted.   |                 |
|       | 0.00 ... 100000.00 $\mu$ F | Capacitance of custom sine filter.  | 100 = 1 $\mu$ F |

**200 Safety**

FSO-xx settings.

This group contains parameters related to the optional FSO-xx safety functions module. For details on the parameters in this group, refer to the documentation of the FSO-xx module.



## 7

# Additional parameter data

---

## What this chapter contains

This chapter lists the parameters with some additional data such as their ranges and 32-bit fieldbus scaling. For parameter descriptions, see chapter [Parameters](#) (page [111](#)).

## Terms and abbreviations

| Term          | Definition   |
|---------------|--|
| Actual signal | Signal measured or calculated by the drive. Usually can only be monitored but not adjusted; some counter-type signals can however be reset.  |
| Analog src    | <p>Analog source: the parameter can be set to the value of another parameter by choosing “Other”, and selecting the source parameter from a list.</p> <p><b>Note:</b> The source parameter must be a 32-bit real (floating point) number. To use a 16-bit integer (for example, received in DDCS data sets) as the source, data storage parameters <a href="#">47.01...47.08</a> (see page <a href="#">328</a>) can be used.</p> <p>In addition to the “Other” selection, the parameter may offer other pre-selected settings.</p> |
| Binary src    | Binary source: the value of the parameter can be taken from a specific bit in another parameter value (“Other”). Sometimes the value can be fixed to 0 (false) or 1 (true). In addition, the parameter may offer other pre-selected settings.  |
| Data          | Data parameter.  |

---

| Term   | Definition  |
|--------|---|
| FbEq32 | 32-bit fieldbus equivalent: The scaling between the value shown on the panel and the integer used in communication when a 32-bit value is selected for transmission to an external system.<br>The corresponding 16-bit scalings are listed in chapter <a href="#">Parameters</a> (page <a href="#">111</a> ). |
| List   | Selection list.   |
| No.    | Parameter number.   |
| PB     | Packed Boolean (bit list).  |
| Real   | Real number.  |
| Type   | Parameter type. See <a href="#">Analog src</a> , <a href="#">Binary src</a> , <a href="#">List</a> , <a href="#">PB</a> , <a href="#">Real</a> .  |

## Fieldbus addresses

Refer to the *User's manual* of the fieldbus adapter.

---



## Parameter groups 1...9

| No.                     | Name                         | Type        | Range                  | Unit         | FbEq32        |
|-------------------------|------------------------------|-------------|------------------------|--------------|---------------|
| <b>01 Actual values</b> |                              |             |                        |              |               |
| 01.01                   | Motor speed used             | <i>Real</i> | -30000.00 ... 30000.00 | rpm          | 100 = 1 rpm   |
| 01.02                   | Motor speed estimated        | <i>Real</i> | -30000.00 ... 30000.00 | rpm          | 100 = 1 rpm   |
| 01.03                   | Motor speed %                | <i>Real</i> | -1000.00 ... 1000.00   | %            | 100 = 1%      |
| 01.04                   | Encoder 1 speed filtered     | <i>Real</i> | -30000.00 ... 30000.00 | rpm          | 100 = 1 rpm   |
| 01.05                   | Encoder 2 speed filtered     | <i>Real</i> | -30000.00 ... 30000.00 | rpm          | 100 = 1 rpm   |
| 01.06                   | Output frequency             | <i>Real</i> | -500.00 ... 500.00     | Hz           | 100 = 1 Hz    |
| 01.07                   | Motor current                | <i>Real</i> | 0.00 ... 30000.00      | A            | 100 = 1 A     |
| 01.08                   | Motor current % of motor nom | <i>Real</i> | 0.0 ... 1000.0         | %            | 10 = 1%       |
| 01.10                   | Motor torque                 | <i>Real</i> | -1600.0 ... 1600.0     | %            | 10 = 1%       |
| 01.11                   | DC voltage                   | <i>Real</i> | 0.00 ... 2000.00       | V            | 100 = 1 V     |
| 01.13                   | Output voltage               | <i>Real</i> | 0...2000               | V            | 1 = 1 V       |
| 01.14                   | Output power                 | <i>Real</i> | -32768.00 ... 32767.00 | kW or hp     | 100 = 1 unit  |
| 01.15                   | Output power % of motor nom  | <i>Real</i> | -300.00 ... 300.00     | %            | 10 = 1%       |
| 01.17                   | Motor shaft power            | <i>Real</i> | -32768.00 ... 32767.00 | kW or hp     | 100 = 1 unit  |
| 01.18                   | Inverter GWh motoring        | <i>Real</i> | 0...32767              | GWh          | 1 = 1 GWh     |
| 01.19                   | Inverter MWh motoring        | <i>Real</i> | 0...999                | MWh          | 1 = 1 MWh     |
| 01.20                   | Inverter kWh motoring        | <i>Real</i> | 0...999                | kWh          | 1 = 1 kWh     |
| 01.21                   | U-phase current              | <i>Real</i> | -30000.00 ... 30000.00 | A            | 100 = 1 A     |
| 01.22                   | V-phase current              | <i>Real</i> | -30000.00 ... 30000.00 | A            | 100 = 1 A     |
| 01.23                   | W-phase current              | <i>Real</i> | -30000.00 ... 30000.00 | A            | 100 = 1 A     |
| 01.24                   | Flux actual %                | <i>Real</i> | 0...200                | %            | 1 = 1%        |
| 01.25                   | INU momentary cos fii        | <i>Real</i> | -1.00 ... 1.00         | -            | 100 = 1       |
| 01.29                   | Speed change rate            | <i>Real</i> | -15000 ... 15000       | rpm/s        | 1 = 1 rpm/s   |
| 01.30                   | Nominal torque scale         | <i>Real</i> | 0.000...               | N·m or lb·ft | 1000 = 1 unit |
| 01.31                   | Ambient temperature          | <i>Real</i> | -40 ... 120            | °C or °F     | 10 = 1°       |
| 01.32                   | Inverter GWh regenerating    | <i>Real</i> | 0...32767              | GWh          | 1 = 1 GWh     |
| 01.33                   | Inverter MWh regenerating    | <i>Real</i> | 0...999                | MWh          | 1 = 1 MWh     |
| 01.34                   | Inverter kWh regenerating    | <i>Real</i> | 0...999                | kWh          | 1 = 1 kWh     |
| 01.35                   | Mot - regen energy GWh       | <i>Real</i> | -32768 ... 32767       | GWh          | 1 = 1 GWh     |
| 01.36                   | Mot - regen energy MWh       | <i>Real</i> | -999...999             | MWh          | 1 = 1 MWh     |
| 01.37                   | Mot - regen energy kWh       | <i>Real</i> | -999...999             | kWh          | 1 = 1 kWh     |
| 01.61                   | Abs motor speed used         | <i>Real</i> | 0.00 ... 30000.00      | rpm          | 100 = 1 rpm   |
| 01.62                   | Abs motor speed %            | <i>Real</i> | 0.00 ... 1000.00       | %            | 100 = 1%      |
| 01.63                   | Abs output frequency         | <i>Real</i> | 0.00 ... 500.00        | Hz           | 100 = 1 Hz    |
| 01.64                   | Abs motor torque             | <i>Real</i> | 0.0 ... 1600.0         | %            | 10 = 1%       |
| 01.65                   | Abs output power             | <i>Real</i> | 0.00 ... 32767.00      | kW or hp     | 100 = 1 unit  |
| 01.66                   | Abs output power % motor nom | <i>Real</i> | 0.00 ... 300.00        | %            | 10 = 1%       |

## 434 Additional parameter data

| No.   | Name                  | Type        | Range                    | Unit     | FbEq32       |
|---|-----------------------|-------------|--------------------------|----------|--------------|
| 01.68   | Abs motor shaft power | <i>Real</i> | 0.00 ... 32767.00        | kW or hp | 100 = 1 unit |
| 01.70   | Ambient temperature % | <i>Real</i> | -200.00 ... 200.00       | %        | 100 = 1%     |
| 01.71   | Step-up motor current | <i>Real</i> | 0.00 ... 30000.00        | A        | 100 = 1 A    |
| 01.72   | U-phase RMS current   | <i>Real</i> | 0.00 ... 30000.00        | A        | 100 = 1 A    |
| 01.73   | V-phase RMS current   | <i>Real</i> | 0.00 ... 30000.00        | A        | 100 = 1 A    |
| 01.74   | W-phase RMS current   | <i>Real</i> | 0.00 ... 30000.00        | A        | 100 = 1 A    |
| <i>(Parameters 01.102...01.164 only visible when IGBT supply unit control activated by 95.20)</i> |                       |             |                          |          |              |
| 01.102  | Line current          | <i>Real</i> | 0.00 ... 30000.00        | A        | 100 = 1 A    |
| 01.104  | Active current        | <i>Real</i> | 0.00 ... 30000.00        | A        | 100 = 1 A    |
| 01.106  | Reactive current      | <i>Real</i> | 0.00 ... 30000.00        | A        | 100 = 1 A    |
| 01.108  | Grid frequency        | <i>Real</i> | 0.00 ... 100.00          | Hz       | 100 = 1 Hz   |
| 01.109  | Grid voltage          | <i>Real</i> | 0.00 ... 2000.00         | V        | 100 = 1 V    |
| 01.110  | Grid apparent power   | <i>Real</i> | -30000.00 ... 30000.00   | kVA      | 100 = 1 kVA  |
| 01.112  | Grid power            | <i>Real</i> | -30000.00 ... 30000.00   | kW       | 100 = 1 kW   |
| 01.114  | Grid reactive power   | <i>Real</i> | -30000.00 ... 30000.00   | kvar     | 100 = 1 kvar |
| 01.116  | LSU cos $\Phi$        | <i>Real</i> | -1.00 ... 1.00           | -        | 100 = 1      |
| 01.164  | LSU nominal power     | <i>Real</i> | 0...30000                | kW       | 1 = 1 kW     |
| <b>03 Input references</b>  |                       |             |                          |          |              |
| 03.01   | Panel reference       | <i>Real</i> | -100000.00 ... 100000.00 | -        | 100 = 1      |
| 03.02   | Panel reference 2     | <i>Real</i> | -30000.00 ... 30000.00   | -        | 100 = 1      |
| 03.05   | FB A reference 1      | <i>Real</i> | -100000.00 ... 100000.00 | -        | 100 = 1      |
| 03.06   | FB A reference 2      | <i>Real</i> | -100000.00 ... 100000.00 | -        | 100 = 1      |
| 03.07   | FB B reference 1      | <i>Real</i> | -100000.00 ... 100000.00 | -        | 100 = 1      |
| 03.08   | FB B reference 2      | <i>Real</i> | -100000.00 ... 100000.00 | -        | 100 = 1      |
| 03.09   | EFB reference 1       | <i>Real</i> | -30000.00 ... 30000.00   | -        | 100 = 1      |
| 03.10   | EFB reference 2       | <i>Real</i> | -30000.00 ... 30000.00   | -        | 100 = 1      |
| 03.11   | DDCS controller ref 1 | <i>Real</i> | -30000.00 ... 30000.00   | -        | 100 = 1      |
| 03.12   | DDCS controller ref 2 | <i>Real</i> | -30000.00 ... 30000.00   | -        | 100 = 1      |
| 03.13   | M/F or D2D ref1       | <i>Real</i> | -30000.00 ... 30000.00   | -        | 100 = 1      |
| 03.14   | M/F or D2D ref2       | <i>Real</i> | -30000.00 ... 30000.00   | -        | 100 = 1      |
| <b>04 Warnings and faults</b>   |                       |             |                          |          |              |
| 04.01   | Tripping fault        | <i>Data</i> | 0000h...FFFFh            | -        | 1 = 1        |
| 04.02   | Active fault 2        | <i>Data</i> | 0000h...FFFFh            | -        | 1 = 1        |
| 04.03   | Active fault 3        | <i>Data</i> | 0000h...FFFFh            | -        | 1 = 1        |
| 04.04   | Active fault 4        | <i>Data</i> | 0000h...FFFFh            | -        | 1 = 1        |
| 04.05   | Active fault 5        | <i>Data</i> | 0000h...FFFFh            | -        | 1 = 1        |
| 04.06   | Active warning 1      | <i>Data</i> | 0000h...FFFFh            | -        | 1 = 1        |
| 04.07   | Active warning 2      | <i>Data</i> | 0000h...FFFFh            | -        | 1 = 1        |
| 04.08   | Active warning 3      | <i>Data</i> | 0000h...FFFFh            | -        | 1 = 1        |
| 04.09   | Active warning 4      | <i>Data</i> | 0000h...FFFFh            | -        | 1 = 1        |
| 04.10   | Active warning 5      | <i>Data</i> | 0000h...FFFFh            | -        | 1 = 1        |

| No.   | Name                             | Type        | Range                        | Unit | FbEq32  |
|---|----------------------------------|-------------|------------------------------|------|---------|
| 04.11   | Latest fault                     | <i>Data</i> | 0000h...FFFFh                | -    | 1 = 1   |
| 04.12   | 2nd latest fault                 | <i>Data</i> | 0000h...FFFFh                | -    | 1 = 1   |
| 04.13   | 3rd latest fault                 | <i>Data</i> | 0000h...FFFFh                | -    | 1 = 1   |
| 04.14   | 4th latest fault                 | <i>Data</i> | 0000h...FFFFh                | -    | 1 = 1   |
| 04.15   | 5th latest fault                 | <i>Data</i> | 0000h...FFFFh                | -    | 1 = 1   |
| 04.16   | Latest warning                   | <i>Data</i> | 0000h...FFFFh                | -    | 1 = 1   |
| 04.17   | 2nd latest warning               | <i>Data</i> | 0000h...FFFFh                | -    | 1 = 1   |
| 04.18   | 3rd latest warning               | <i>Data</i> | 0000h...FFFFh                | -    | 1 = 1   |
| 04.19   | 4th latest warning               | <i>Data</i> | 0000h...FFFFh                | -    | 1 = 1   |
| 04.20   | 5th latest warning               | <i>Data</i> | 0000h...FFFFh                | -    | 1 = 1   |
| 04.21   | Fault word 1                     | <i>PB</i>   | 0000h...FFFFh                | -    | 1 = 1   |
| 04.22   | Fault word 2                     | <i>PB</i>   | 0000h...FFFFh                | -    | 1 = 1   |
| 04.31   | Warning word 1                   | <i>PB</i>   | 0000h...FFFFh                | -    | 1 = 1   |
| 04.32   | Warning word 2                   | <i>PB</i>   | 0000h...FFFFh                | -    | 1 = 1   |
| 04.40   | Event word 1                     | <i>PB</i>   | 0000h...FFFFh                | -    | 1 = 1   |
| 04.41   | Event word 1 bit 0 code          | <i>Data</i> | 0000h...FFFFh                | -    | 1 = 1   |
| 04.42   | Event word 1 bit 0 aux code      | <i>Data</i> | 0000 0000h ...<br>FFFF FFFFh | -    | 1 = 1   |
| 04.43   | Event word 1 bit 1 code          | <i>Data</i> | 0000h...FFFFh                | -    | 1 = 1   |
| 04.44   | Event word 1 bit 1 aux code      | <i>Data</i> | 0000 0000h ...<br>FFFF FFFFh | -    | 1 = 1   |
| ...   | ...                              | ...         | ...                          | ...  |         |
| 04.71   | Event word 1 bit 15 code         | <i>Data</i> | 0000h...FFFFh                | -    | 1 = 1   |
| 04.72   | Event word 1 bit 15 aux code     | <i>Data</i> | 0000 0000h ...<br>FFFF FFFFh | -    | 1 = 1   |
| 04.120  | Fault/Warning word compatibility | <i>List</i> | 0...1                        | -    | 1 = 1   |
| <b>05 Diagnostics</b>   |                                  |             |                              |      |         |
| 05.01   | On-time counter                  | <i>Real</i> | 0...65535                    | d    | 1 = 1 d |
| 05.02   | Run-time counter                 | <i>Real</i> | 0...65535                    | d    | 1 = 1 d |
| 05.04   | Fan on-time counter              | <i>Real</i> | 0...65535                    | d    | 1 = 1 d |
| 05.11   | Inverter temperature             | <i>Real</i> | -40.0 ... 160.0              | %    | 10 = 1% |
| 05.22   | Diagnostic word 3                | <i>PB</i>   | 0000h...FFFFh                | -    |         |
| 05.41   | Main fan service counter         | <i>Real</i> | 0...150                      | %    | 1 = 1%  |
| 05.42   | Aux. fan service counter         | <i>Real</i> | 0...150                      | %    | 1 = 1%  |
| <i>(Parameters 05.111...05.121 only visible when IGBT supply unit control activated by 95.20)</i> |                                  |             |                              |      |         |
| 05.111  | Line converter temperature       | <i>Real</i> | -40.0 ... 160.0              | %    | 10 = 1% |
| 05.121  | MCB closing counter              | <i>Real</i> | 0...4294967295               | %    | 1 = 1   |
| <b>06 Control and status words</b>  |                                  |             |                              |      |         |
| 06.01   | Main control word                | <i>PB</i>   | 0000h...FFFFh                | -    | 1 = 1   |
| 06.02   | Application control word         | <i>PB</i>   | 0000h...FFFFh                | -    | 1 = 1   |
| 06.03   | FBA A transparent control word   | <i>PB</i>   | 00000000h...FFFFFFFFh        | -    | 1 = 1   |

## 436 Additional parameter data

| No.  | Name                             | Type              | Range                 | Unit | FbEq32 |
|--|----------------------------------|-------------------|-----------------------|------|--------|
| 06.04  | FBA B transparent control word   | <i>PB</i>         | 00000000h...FFFFFFFFh | -    |        |
| 06.05  | EFB transparent control word     | <i>PB</i>         | 00000000h...FFFFFFFFh | -    |        |
| 06.11  | Main status word                 | <i>PB</i>         | 0000h...FFFFh         | -    | 1 = 1  |
| 06.16  | Drive status word 1              | <i>PB</i>         | 0000h...FFFFh         | -    | 1 = 1  |
| 06.17  | Drive status word 2              | <i>PB</i>         | 0000h...FFFFh         | -    | 1 = 1  |
| 06.18  | Start inhibit status word        | <i>PB</i>         | 0000h...FFFFh         | -    | 1 = 1  |
| 06.19  | Speed control status word        | <i>PB</i>         | 0000h...FFFFh         | -    | 1 = 1  |
| 06.20  | Constant speed status word       | <i>PB</i>         | 0000h...FFFFh         | -    | 1 = 1  |
| 06.21  | Drive status word 3              | <i>PB</i>         | 0000h...FFFFh         | -    | 1 = 1  |
| 06.25  | Drive inhibit status word 2      | <i>PB</i>         | 0000h...FFFFh         | -    | 1 = 1  |
| 06.29  | MSW bit 10 sel                   | <i>Binary src</i> | -                     | -    | 1 = 1  |
| 06.30  | MSW bit 11 sel                   | <i>Binary src</i> | -                     | -    | 1 = 1  |
| 06.31  | MSW bit 12 sel                   | <i>Binary src</i> | -                     | -    | 1 = 1  |
| 06.32  | MSW bit 13 sel                   | <i>Binary src</i> | -                     | -    | 1 = 1  |
| 06.33  | MSW bit 14 sel                   | <i>Binary src</i> | -                     | -    | 1 = 1  |
| <i>(Parameters 06.36...06.43 only visible when supply unit control activated by 95.20)</i> |                                  |                   |                       |      |        |
| 06.36  | LSU Status Word                  | <i>PB</i>         | 0000h...FFFFh         | -    | 1 = 1  |
| 06.39  | Internal state machine LSU CW    | <i>PB</i>         | 0000h...FFFFh         | -    | 1 = 1  |
| 06.40  | LSU CW user bit 0 selection      | <i>Binary src</i> | -                     | -    | 1 = 1  |
| 06.41  | LSU CW user bit 1 selection      | <i>Binary src</i> | -                     | -    | 1 = 1  |
| 06.42  | LSU CW user bit 2 selection      | <i>Binary src</i> | -                     | -    | 1 = 1  |
| 06.43  | LSU CW user bit 3 selection      | <i>Binary src</i> | -                     | -    | 1 = 1  |
| 06.45  | Follower CW user bit 0 selection | <i>Binary src</i> | -                     | -    | 1 = 1  |
| 06.46  | Follower CW user bit 1 selection | <i>Binary src</i> | -                     | -    | 1 = 1  |
| 06.47  | Follower CW user bit 2 selection | <i>Binary src</i> | -                     | -    | 1 = 1  |
| 06.48  | Follower CW user bit 3 selection | <i>Binary src</i> | -                     | -    | 1 = 1  |
| 06.50  | User status word 1               | <i>PB</i>         | 0000h...FFFFh         | -    | 1 = 1  |
| 06.60  | User status word 1 bit 0 sel     | <i>Binary src</i> | -                     | -    | 1 = 1  |
| 06.61  | User status word 1 bit 1 sel     | <i>Binary src</i> | -                     | -    | 1 = 1  |

| No.   | Name                             | Type              | Range         | Unit | FbEq32 |
|---|----------------------------------|-------------------|---------------|------|--------|
| 06.62   | User status word 1 bit 2 sel     | <i>Binary src</i> | -             | -    | 1 = 1  |
| 06.63   | User status word 1 bit 3 sel     | <i>Binary src</i> | -             | -    | 1 = 1  |
| 06.64   | User status word 1 bit 4 sel     | <i>Binary src</i> | -             | -    | 1 = 1  |
| 06.65   | User status word 1 bit 5 sel     | <i>Binary src</i> | -             | -    | 1 = 1  |
| 06.66   | User status word 1 bit 6 sel     | <i>Binary src</i> | -             | -    | 1 = 1  |
| 06.67   | User status word 1 bit 7 sel     | <i>Binary src</i> | -             | -    | 1 = 1  |
| 06.68   | User status word 1 bit 8 sel     | <i>Binary src</i> | -             | -    | 1 = 1  |
| 06.69   | User status word 1 bit 9 sel     | <i>Binary src</i> | -             | -    | 1 = 1  |
| 06.70   | User status word 1 bit 10 sel    | <i>Binary src</i> | -             | -    | 1 = 1  |
| 06.71   | User status word 1 bit 11 sel    | <i>Binary src</i> | -             | -    | 1 = 1  |
| 06.72   | User status word 1 bit 12 sel    | <i>Binary src</i> | -             | -    | 1 = 1  |
| 06.73   | User status word 1 bit 13 sel    | <i>Binary src</i> | -             | -    | 1 = 1  |
| 06.74   | User status word 1 bit 14 sel    | <i>Binary src</i> | -             | -    | 1 = 1  |
| 06.75   | User status word 1 bit 15 sel    | <i>Binary src</i> | -             | -    | 1 = 1  |
| 06.100  | User control word 1              | <i>PB</i>         | 0000h...FFFFh | -    | 1 = 1  |
| 06.101  | User control word 2              | <i>PB</i>         | 0000h...FFFFh | -    | 1 = 1  |
| <i>(Parameters 06.116...06.118 only visible when IGBT supply unit control activated by 95.20)</i> |                                  |                   |               |      |        |
| 06.116  | LSU drive status word 1          | <i>PB</i>         | 0000h...FFFFh | -    | 1 = 1  |
| 06.118  | LSU start inhibit status word    | <i>PB</i>         | 0000h...FFFFh | -    | 1 = 1  |
| <b>07 System info</b>   |                                  |                   |               |      |        |
| 07.03   | Drive rating id                  | <i>List</i>       | -             | -    | 1 = 1  |
| 07.04   | Firmware name                    | <i>List</i>       | -             | -    | 1 = 1  |
| 07.05   | Firmware version                 | <i>Data</i>       | -             | -    | 1 = 1  |
| 07.06   | Loading package name             | <i>List</i>       | -             | -    | 1 = 1  |
| 07.07   | Loading package version          | <i>Data</i>       | -             | -    | 1 = 1  |
| 07.08   | Bootloader version               | <i>Data</i>       | -             | -    | 1 = 1  |
| 07.11   | Cpu usage                        | <i>Real</i>       | 0...100       | %    | 1 = 1% |
| 07.13   | PU logic version number          | <i>Data</i>       | -             | -    | 1 = 1  |
| <i>(Parameters 07.21...07.24 only visible with option +N8010 [application programmability])</i>   |                                  |                   |               |      |        |
| 07.21   | Application environment status 1 | <i>PB</i>         | 0000h...FFFFh | -    | 1 = 1  |

## 438 Additional parameter data

| No.   | Name                             | Type        | Range         | Unit | FbEq32  |
|---|----------------------------------|-------------|---------------|------|---------|
| 07.22   | Application environment status 2 | <i>PB</i>   | 0000h...FFFFh | -    | 1 = 1   |
| 07.23   | Application name                 | <i>Data</i> | -             | -    | 1 = 1   |
| 07.24   | Application version              | <i>Data</i> | -             | -    | 1 = 1   |
| 07.25   | Customization package name       | <i>Data</i> | -             | -    | 1 = 1   |
| 07.26   | Customization package version    | <i>Data</i> | -             | -    | 1 = 1   |
| 07.30   | Adaptive program status          | <i>PB</i>   | 0000h...FFFFh | -    | 1 = 1   |
| <i>(Parameters 07.40...07.41 only visible with option +N8010 [application programmability])</i>   |                                  |             |               |      |         |
| 07.40   | IEC application Cpu usage peak   | <i>Real</i> | 0.0 ... 100.0 | %    | 10 = 1% |
| 07.41   | IEC application Cpu load average | <i>Real</i> | 0.0 ... 100.0 | %    | 10 = 1% |
| <i>(Parameters 07.106...07.107 only visible when IGBT supply unit control activated by 95.20)</i> |                                  |             |               |      |         |
| 07.106  | LSU loading package name         | <i>List</i> | -             | -    | 1 = 1   |
| 07.107  | LSU loading package version      | <i>Data</i> | -             | -    | 1 = 1   |

## Parameter groups 10...99

| No.                            | Name                | Type              | Range          | Unit | FbEq32    |
|--------------------------------|---------------------|-------------------|----------------|------|-----------|
| <b>10 Standard DI, RO</b>      |                     |                   |                |      |           |
| 10.01                          | DI status           | <i>PB</i>         | 0000h...FFFFh  | -    | 1 = 1     |
| 10.02                          | DI delayed status   | <i>PB</i>         | 0000h...FFFFh  | -    | 1 = 1     |
| 10.03                          | DI force selection  | <i>PB</i>         | 0000h...FFFFh  | -    | 1 = 1     |
| 10.04                          | DI force data       | <i>PB</i>         | 0000h...FFFFh  | -    | 1 = 1     |
| 10.05                          | DI1 ON delay        | <i>Real</i>       | 0.0 ... 3000.0 | s    | 10 = 1 s  |
| 10.06                          | DI1 OFF delay       | <i>Real</i>       | 0.0 ... 3000.0 | s    | 10 = 1 s  |
| 10.07                          | DI2 ON delay        | <i>Real</i>       | 0.0 ... 3000.0 | s    | 10 = 1 s  |
| 10.08                          | DI2 OFF delay       | <i>Real</i>       | 0.0 ... 3000.0 | s    | 10 = 1 s  |
| 10.09                          | DI3 ON delay        | <i>Real</i>       | 0.0 ... 3000.0 | s    | 10 = 1 s  |
| 10.10                          | DI3 OFF delay       | <i>Real</i>       | 0.0 ... 3000.0 | s    | 10 = 1 s  |
| 10.11                          | DI4 ON delay        | <i>Real</i>       | 0.0 ... 3000.0 | s    | 10 = 1 s  |
| 10.12                          | DI4 OFF delay       | <i>Real</i>       | 0.0 ... 3000.0 | s    | 10 = 1 s  |
| 10.13                          | DI5 ON delay        | <i>Real</i>       | 0.0 ... 3000.0 | s    | 10 = 1 s  |
| 10.14                          | DI5 OFF delay       | <i>Real</i>       | 0.0 ... 3000.0 | s    | 10 = 1 s  |
| 10.15                          | DI6 ON delay        | <i>Real</i>       | 0.0 ... 3000.0 | s    | 10 = 1 s  |
| 10.16                          | DI6 OFF delay       | <i>Real</i>       | 0.0 ... 3000.0 | s    | 10 = 1 s  |
| 10.21                          | RO status           | <i>PB</i>         | 0000h...FFFFh  | -    | 1 = 1     |
| 10.24                          | RO1 source          | <i>Binary src</i> | -              | -    | 1 = 1     |
| 10.25                          | RO1 ON delay        | <i>Real</i>       | 0.0 ... 3000.0 | s    | 10 = 1 s  |
| 10.26                          | RO1 OFF delay       | <i>Real</i>       | 0.0 ... 3000.0 | s    | 10 = 1 s  |
| 10.27                          | RO2 source          | <i>Binary src</i> | -              | -    | 1 = 1     |
| 10.28                          | RO2 ON delay        | <i>Real</i>       | 0.0 ... 3000.0 | s    | 10 = 1 s  |
| 10.29                          | RO2 OFF delay       | <i>Real</i>       | 0.0 ... 3000.0 | s    | 10 = 1 s  |
| 10.30                          | RO3 source          | <i>Binary src</i> | -              | -    | 1 = 1     |
| 10.31                          | RO3 ON delay        | <i>Real</i>       | 0.0 ... 3000.0 | s    | 10 = 1 s  |
| 10.32                          | RO3 OFF delay       | <i>Real</i>       | 0.0 ... 3000.0 | s    | 10 = 1 s  |
| 10.51                          | DI filter time      | <i>Real</i>       | 0.3 ... 100.0  | ms   | 10 = 1 ms |
| 10.99                          | RO/DIO control word | <i>PB</i>         | 0000h...FFFFh  | -    | 1 = 1     |
| <b>11 Standard DIO, FI, FO</b> |                     |                   |                |      |           |
| 11.01                          | DIO status          | <i>PB</i>         | 0000h...FFFFh  | -    | 1 = 1     |
| 11.02                          | DIO delayed status  | <i>PB</i>         | 0000h...FFFFh  | -    | 1 = 1     |
| 11.05                          | DIO1 function       | <i>List</i>       | 0...2          | -    | 1 = 1     |
| 11.06                          | DIO1 output source  | <i>Binary src</i> | -              | -    | 1 = 1     |
| 11.07                          | DIO1 ON delay       | <i>Real</i>       | 0.0 ... 3000.0 | s    | 10 = 1 s  |
| 11.08                          | DIO1 OFF delay      | <i>Real</i>       | 0.0 ... 3000.0 | s    | 10 = 1 s  |
| 11.09                          | DIO2 function       | <i>List</i>       | 0...2          | -    | 1 = 1     |

## 440 Additional parameter data

| No.                   | Name                     | Type              | Range                    | Unit    | FbEq32           |
|-----------------------|--------------------------|-------------------|--------------------------|---------|------------------|
| 11.10                 | DIO2 output source       | <i>Binary src</i> | -                        |         | 1 = 1            |
| 11.11                 | DIO2 ON delay            | <i>Real</i>       | 0.0 ... 3000.0           | s       | 10 = 1 s         |
| 11.12                 | DIO2 OFF delay           | <i>Real</i>       | 0.0 ... 3000.0           | s       | 10 = 1 s         |
| 11.38                 | Freq in 1 actual value   | <i>Real</i>       | 0...16000                | Hz      | 1 = 1 Hz         |
| 11.39                 | Freq in 1 scaled         | <i>Real</i>       | -32768.000 ... 32767.000 | -       | 1000 = 1         |
| 11.42                 | Freq in 1 min            | <i>Real</i>       | 0...16000                | Hz      | 1 = 1 Hz         |
| 11.43                 | Freq in 1 max            | <i>Real</i>       | 0...16000                | Hz      | 1 = 1 Hz         |
| 11.44                 | Freq in 1 at scaled min  | <i>Real</i>       | -32768.000 ... 32767.000 | -       | 1000 = 1         |
| 11.45                 | Freq in 1 at scaled max  | <i>Real</i>       | -32768.000 ... 32767.000 | -       | 1000 = 1         |
| 11.54                 | Freq out 1 actual value  | <i>Real</i>       | 0...16000                | Hz      | 1 = 1 Hz         |
| 11.55                 | Freq out 1 source        | <i>Analog src</i> | -                        | -       | 1 = 1            |
| 11.58                 | Freq out 1 src min       | <i>Real</i>       | -32768.000 ... 32767.000 | -       | 1000 = 1         |
| 11.59                 | Freq out 1 src max       | <i>Real</i>       | -32768.000 ... 32767.000 | -       | 1000 = 1         |
| 11.60                 | Freq out 1 at src min    | <i>Real</i>       | 0...16000                | Hz      | 1 = 1 Hz         |
| 11.61                 | Freq out 1 at src max    | <i>Real</i>       | 0...16000                | Hz      | 1 = 1 Hz         |
| 11.81                 | DIO filter time          | <i>Real</i>       | 0.3 ... 100.0            | ms      | 10 = 1 ms        |
| <b>12 Standard AI</b> |                          |                   |                          |         |                  |
| 12.01                 | AI tune                  | enum              | 0...4                    | -       |                  |
| 12.03                 | AI supervision function  | <i>List</i>       | 0...4                    | -       | 1 = 1            |
| 12.04                 | AI supervision selection | <i>PB</i>         | 0000h...FFFFh            | -       | 1 = 1            |
| 12.05                 | AI supervision force     | <i>PB</i>         | 0000h...FFFFh            | -       | 1 = 1            |
| 12.11                 | AI1 actual value         | <i>Real</i>       | -22.000 ... 22.000       | mA or V | 1000 = 1 unit    |
| 12.12                 | AI1 scaled value         | <i>Real</i>       | -32768.000 ... 32767.000 | -       | 1000 = 1         |
| 12.15                 | AI1 unit selection       | <i>List</i>       | -                        | -       | 1 = 1            |
| 12.16                 | AI1 filter time          | <i>Real</i>       | 0.000 ... 30.000         | s       | 1000 = 1 s       |
| 12.17                 | AI1 min                  | <i>Real</i>       | -22.000 ... 22.000       | mA or V | 1000 = 1 mA or V |
| 12.18                 | AI1 max                  | <i>Real</i>       | -22.000 ... 22.000       | mA or V | 1000 = 1 mA or V |
| 12.19                 | AI1 scaled at AI1 min    | <i>Real</i>       | -32768.000 ... 32767.000 | -       | 1000 = 1         |
| 12.20                 | AI1 scaled at AI1 max    | <i>Real</i>       | -32768.000 ... 32767.000 | -       | 1000 = 1         |
| 12.21                 | AI2 actual value         | <i>Real</i>       | -22.000 ... 22.000       | mA or V | 1000 = 1 mA or V |
| 12.22                 | AI2 scaled value         | <i>Real</i>       | -32768.000 ... 32767.000 | -       | 1000 = 1         |
| 12.25                 | AI2 unit selection       | <i>List</i>       | -                        | -       | 1 = 1            |
| 12.26                 | AI2 filter time          | <i>Real</i>       | 0.000 ... 30.000         | s       | 1000 = 1 s       |
| 12.27                 | AI2 min                  | <i>Real</i>       | -22.000 ... 22.000       | mA or V | 1000 = 1 mA or V |
| 12.28                 | AI2 max                  | <i>Real</i>       | -22.000 ... 22.000       | mA or V | 1000 = 1 mA or V |
| 12.29                 | AI2 scaled at AI2 min    | <i>Real</i>       | -32768.000 ... 32767.000 | -       | 1000 = 1         |



| No.  | Name                   | Type              | Range                    | Unit | FbEq32      |
|--|------------------------|-------------------|--------------------------|------|-------------|
| 12.30  | AI2 scaled at AI2 max  | <i>Real</i>       | -32768.000 ... 32767.000 | -    | 1000 = 1    |
| <b>13 Standard AO</b>  |                        |                   |                          |      |             |
| 13.11  | AO1 actual value       | <i>Real</i>       | 0.000 ... 22.000         | mA   | 1000 = 1 mA |
| 13.12  | AO1 source             | <i>Analog src</i> | -                        | -    | 1 = 1       |
| 13.16  | AO1 filter time        | <i>Real</i>       | 0.000 ... 30.000         | s    | 1000 = 1 s  |
| 13.17  | AO1 source min         | <i>Real</i>       | -32768.0 ... 32767.0     | -    | 10 = 1      |
| 13.18  | AO1 source max         | <i>Real</i>       | -32768.0 ... 32767.0     | -    | 10 = 1      |
| 13.19  | AO1 out at AO1 src min | <i>Real</i>       | 0.000 ... 22.000         | mA   | 1000 = 1 mA |
| 13.20  | AO1 out at AO1 src max | <i>Real</i>       | 0.000 ... 22.000         | mA   | 1000 = 1 mA |
| 13.21  | AO2 actual value       | <i>Real</i>       | 0.000 ... 22.000         | mA   | 1000 = 1 mA |
| 13.22  | AO2 source             | <i>Analog src</i> | -                        | -    | 1 = 1       |
| 13.26  | AO2 filter time        | <i>Real</i>       | 0.000 ... 30.000         | s    | 1000 = 1 s  |
| 13.27  | AO2 source min         | <i>Real</i>       | -32768.0 ... 32767.0     | -    | 10 = 1      |
| 13.28  | AO2 source max         | <i>Real</i>       | -32768.0 ... 32767.0     | -    | 10 = 1      |
| 13.29  | AO2 out at AO2 src min | <i>Real</i>       | 0.000 ... 22.000         | mA   | 1000 = 1 mA |
| 13.30  | AO2 out at AO2 src max | <i>Real</i>       | 0.000 ... 22.000         | mA   | 1000 = 1 mA |
| 13.91  | AO1 data storage       | <i>Real</i>       | -327.68 ... 327.67       | -    | 100 = 1     |
| 13.92  | AO2 data storage       | <i>Real</i>       | -327.68 ... 327.67       | -    | 100 = 1     |
| <b>14 I/O extension module 1</b>   |                        |                   |                          |      |             |
| 14.01  | Module 1 type          | <i>List</i>       | 0...4                    | -    | 1 = 1       |
| 14.02  | Module 1 location      | <i>Real</i>       | 1...254                  | -    | 1 = 1       |
| 14.03  | Module 1 status        | <i>List</i>       | 0...4                    | -    | 1 = 1       |
| <i>Dlx (14.01 Module 1 type = FDIO-01)</i>                                 |                        |                   |                          |      |             |
| 14.05  | DI status              | <i>PB</i>         | 00000000h...FFFFFFFFh    | -    | 1 = 1       |
| 14.06  | DI delayed status      | <i>PB</i>         | 00000000h...FFFFFFFFh    | -    | 1 = 1       |
| 14.08  | DI filter time         | <i>Real</i>       | 0.8 ... 100.0            | ms   | 10 = 1 ms   |
| 14.12  | DI1 ON delay           | <i>Real</i>       | 0.00 ... 3000.00         | s    | 100 = 1 s   |
| 14.13  | DI1 OFF delay          | <i>Real</i>       | 0.00 ... 3000.00         | s    | 100 = 1 s   |
| 14.17  | DI2 ON delay           | <i>Real</i>       | 0.00 ... 3000.00         | s    | 100 = 1 s   |
| 14.18  | DI2 OFF delay          | <i>Real</i>       | 0.00 ... 3000.00         | s    | 100 = 1 s   |
| 14.22  | DI3 ON delay           | <i>Real</i>       | 0.00 ... 3000.00         | s    | 100 = 1 s   |
| 14.23  | DI3 OFF delay          | <i>Real</i>       | 0.00 ... 3000.00         | s    | 100 = 1 s   |
| <i>Common parameters for DIOx (14.01 Module 1 type = FIO-01 or FIO-11)</i> |                        |                   |                          |      |             |
| 14.05  | DIO status             | <i>PB</i>         | 00000000h...FFFFFFFFh    | -    | 1 = 1       |
| 14.06  | DIO delayed status     | <i>PB</i>         | 00000000h...FFFFFFFFh    | -    | 1 = 1       |
| <i>DIO1/DIO2 (14.01 Module 1 type = FIO-01 or FIO-11)</i>                  |                        |                   |                          |      |             |
| 14.08  | DIO filter time        | <i>Real</i>       | 0.8 ... 100.0            | ms   | 10 = 1 ms   |
| 14.09  | DIO1 function          | <i>List</i>       | 0...1                    | -    | 1 = 1       |
| 14.11  | DIO1 output source     | <i>Binary src</i> | -                        | -    | 1 = 1       |

## 442 Additional parameter data

| No.  | Name                     | Type              | Range   | Unit    | FbEq32        |
|--|--------------------------|-------------------|---|---------|---------------|
| 14.12  | DIO1 ON delay            | <i>Real</i>       | 0.00 ... 3000.00                                    | s       | 100 = 1 s     |
| 14.13  | DIO1 OFF delay           | <i>Real</i>       | 0.00 ... 3000.00                                    | s       | 100 = 1 s     |
| 14.14  | DIO2 function            | <i>List</i>       | 0...1   | -       | 1 = 1         |
| 14.16  | DIO2 output source       | <i>Binary src</i> | -   | -       | 1 = 1         |
| 14.17  | DIO2 ON delay            | <i>Real</i>       | 0.00 ... 3000.00                                    | s       | 100 = 1 s     |
| 14.18  | DIO2 OFF delay           | <i>Real</i>       | 0.00 ... 3000.00                                    | s       | 100 = 1 s     |
| <i>DIO3/DIO4 (14.01 Module 1 type = FIO-01)</i>                            |                          |                   |   |         |               |
| 14.19  | DIO3 function            | <i>List</i>       | 0...1   | -       | 1 = 1         |
| 14.21  | DIO3 output source       | <i>Binary src</i> | -   | -       | 1 = 1         |
| 14.22  | DIO3 ON delay            | <i>Real</i>       | 0.00 ... 3000.00                                    | s       | 100 = 1 s     |
| 14.23  | DIO3 OFF delay           | <i>Real</i>       | 0.00 ... 3000.00                                    | s       | 100 = 1 s     |
| 14.24  | DIO4 function            | <i>List</i>       | 0...1   | -       | 1 = 1         |
| 14.26  | DIO4 output source       | <i>Binary src</i> | -   | -       | 1 = 1         |
| 14.27  | DIO4 ON delay            | <i>Real</i>       | 0.00 ... 3000.00                                    | s       | 100 = 1 s     |
| 14.28  | DIO4 OFF delay           | <i>Real</i>       | 0.00 ... 3000.00                                    | s       | 100 = 1 s     |
| <i>RO1/RO2 (14.01 Module 1 type = FIO-01 or FDIO-01)</i>                   |                          |                   |   |         |               |
| 14.31  | RO status                | <i>PB</i>         | 0000h...FFFFh                                       | -       | 1 = 1         |
| 14.34  | RO1 source               | <i>Binary src</i> | -   | -       | 1 = 1         |
| 14.35  | RO1 ON delay             | <i>Real</i>       | 0.00 ... 3000.00                                    | s       | 100 = 1 s     |
| 14.36  | RO1 OFF delay            | <i>Real</i>       | 0.00 ... 3000.00                                    | s       | 100 = 1 s     |
| 14.37  | RO2 source               | <i>Binary src</i> | -   | -       | 1 = 1         |
| 14.38  | RO2 ON delay             | <i>Real</i>       | 0.00 ... 3000.00                                    | s       | 100 = 1 s     |
| 14.39  | RO2 OFF delay            | <i>Real</i>       | 0.00 ... 3000.00                                    | s       | 100 = 1 s     |
| <i>Common parameters for AIx (14.01 Module 1 type = FIO-11 or FAIO-01)</i> |                          |                   |   |         |               |
| 14.19  | AI supervision function  | <i>List</i>       | 0...4   | -       | 1 = 1         |
| 14.20  | AI supervision selection | <i>PB</i>         | 0000h...FFFFh                                       | -       | 1 = 1         |
| 14.21  | AI tune                  | <i>List</i>       | 0...6 ( <i>FIO-11</i> )<br>0...4 ( <i>FAIO-01</i> ) | -       | 1 = 1         |
| 14.22  | AI force selection       | <i>PB</i>         | 0000h...FFFFh                                       | -       | 1 = 1         |
| <i>AI1/AI2 (14.01 Module 1 type = FIO-11 or FAIO-01)</i>                   |                          |                   |   |         |               |
| 14.26  | AI1 actual value         | <i>Real</i>       | -22.000 ... 22.000                                  | mA or V | 1000 = 1 unit |
| 14.27  | AI1 scaled value         | <i>Real</i>       | -32768.000 ... 32767.000                            | -       | 1000 = 1      |
| 14.28  | AI1 force data           | <i>Real</i>       | -22.000 ... 22.000                                  | mA or V | 1000 = 1 unit |
| 14.29  | AI1 HW switch position   | <i>List</i>       | -   | -       | 1 = 1         |
| 14.30  | AI1 unit selection       | <i>List</i>       | -   | -       | 1 = 1         |
| 14.31  | AI1 filter gain          | <i>List</i>       | 0...7   | -       | 1 = 1         |
| 14.32  | AI1 filter time          | <i>Real</i>       | 0.000 ... 30.000                                    | s       | 1000 = 1 s    |

| No.  | Name                   | Type              | Range                    | Unit    | FbEq32           |
|--|------------------------|-------------------|--------------------------|---------|------------------|
| 14.33  | AI1 min                | <i>Real</i>       | -22.000 ... 22.000       | mA or V | 1000 = 1 mA or V |
| 14.34  | AI1 max                | <i>Real</i>       | -22.000 ... 22.000       | mA or V | 1000 = 1 mA or V |
| 14.35  | AI1 scaled at AI1 min  | <i>Real</i>       | -32768.000 ... 32767.000 | -       | 1000 = 1         |
| 14.36  | AI1 scaled at AI1 max  | <i>Real</i>       | -32768.000 ... 32767.000 | -       | 1000 = 1         |
| 14.41  | AI2 actual value       | <i>Real</i>       | -22.000 ... 22.000       | mA or V | 1000 = 1 unit    |
| 14.42  | AI2 scaled value       | <i>Real</i>       | -32768.000 ... 32767.000 | -       | 1000 = 1         |
| 14.43  | AI2 force data         | <i>Real</i>       | -22.000 ... 22.000       | mA or V | 1000 = 1 unit    |
| 14.44  | AI2 HW switch position | <i>List</i>       | -                        | -       | 1 = 1            |
| 14.45  | AI2 unit selection     | <i>List</i>       | -                        | -       | 1 = 1            |
| 14.46  | AI2 filter gain        | <i>List</i>       | 0...7                    | -       | 1 = 1            |
| 14.47  | AI2 filter time        | <i>Real</i>       | 0.000 ... 30.000         | s       | 1000 = 1 s       |
| 14.48  | AI2 min                | <i>Real</i>       | -22.000 ... 22.000       | mA or V | 1000 = 1 mA or V |
| 14.49  | AI2 max                | <i>Real</i>       | -22.000 ... 22.000       | mA or V | 1000 = 1 mA or V |
| 14.50  | AI2 scaled at AI2 min  | <i>Real</i>       | -32768.000 ... 32767.000 | -       | 1000 = 1         |
| 14.51  | AI2 scaled at AI2 max  | <i>Real</i>       | -32768.000 ... 32767.000 | -       | 1000 = 1         |
| <i>AI3 (14.01 Module 1 type = FIO-11)</i>                                  |                        |                   |                          |         |                  |
| 14.56  | AI3 actual value       | <i>Real</i>       | -22.000 ... 22.000       | mA or V | 1000 = 1 unit    |
| 14.57  | AI3 scaled value       | <i>Real</i>       | -32768.000 ... 32767.000 | -       | 1000 = 1         |
| 14.58  | AI3 force data         | <i>Real</i>       | -22.000 ... 22.000       | mA or V | 1000 = 1 unit    |
| 14.59  | AI3 HW switch position | <i>List</i>       | -                        | -       | 1 = 1            |
| 14.60  | AI3 unit selection     | <i>List</i>       | -                        | -       | 1 = 1            |
| 14.61  | AI3 filter gain        | <i>List</i>       | 0...7                    | -       | 1 = 1            |
| 14.62  | AI3 filter time        | <i>Real</i>       | 0.000 ... 30.000         | s       | 1000 = 1 s       |
| 14.63  | AI3 min                | <i>Real</i>       | -22.000 ... 22.000       | mA or V | 1000 = 1 mA or V |
| 14.64  | AI3 max                | <i>Real</i>       | -22.000 ... 22.000       | mA or V | 1000 = 1 mA or V |
| 14.65  | AI3 scaled at AI3 min  | <i>Real</i>       | -32768.000 ... 32767.000 | -       | 1000 = 1         |
| 14.66  | AI3 scaled at AI3 max  | <i>Real</i>       | -32768.000 ... 32767.000 | -       | 1000 = 1         |
| <i>Common parameters for AOx (14.01 Module 1 type = FIO-11 or FAIO-01)</i> |                        |                   |                          |         |                  |
| 14.71  | AO force selection     | <i>PB</i>         | 00000000h...FFFFFFFFh    | -       | 1 = 1            |
| <i>AO1 (14.01 Module 1 type = FIO-11 or FAIO-01)</i>                       |                        |                   |                          |         |                  |
| 14.76  | AO1 actual value       | <i>Real</i>       | 0.000 ... 22.000         | mA      | 1000 = 1 mA      |
| 14.77  | AO1 source             | <i>Analog src</i> | -                        | -       | 1 = 1            |
| 14.78  | AO1 force data         | <i>Real</i>       | 0.000 ... 22.000         | mA      | 1000 = 1 mA      |
| 14.79  | AO1 filter time        | <i>Real</i>       | 0.000 ... 30.000         | s       | 1000 = 1 s       |
| 14.80  | AO1 source min         | <i>Real</i>       | -32768.0 ... 32767.0     | -       | 10 = 1           |
| 14.81  | AO1 source max         | <i>Real</i>       | -32768.0 ... 32767.0     | -       | 10 = 1           |

#### 444 Additional parameter data

| No.  | Name                   | Type              | Range                 | Unit | FbEq32      |
|--|------------------------|-------------------|-----------------------|------|-------------|
| 14.82  | AO1 out at AO1 src min | <i>Real</i>       | 0.000 ... 22.000      | mA   | 1000 = 1 mA |
| 14.83  | AO1 out at AO1 src max | <i>Real</i>       | 0.000 ... 22.000      | mA   | 1000 = 1 mA |
| <i>AO2 (14.01 Module 1 type = FAIO-01)</i>                                 |                        |                   |                       |      |             |
| 14.86  | AO2 actual value       | <i>Real</i>       | 0.000 ... 22.000      | mA   | 1000 = 1 mA |
| 14.87  | AO2 source             | <i>Analog src</i> | -                     | -    | 1 = 1       |
| 14.88  | AO2 force data         | <i>Real</i>       | 0.000 ... 22.000      | mA   | 1000 = 1 mA |
| 14.89  | AO2 filter time        | <i>Real</i>       | 0.000 ... 30.000      | s    | 1000 = 1 s  |
| 14.90  | AO2 source min         | <i>Real</i>       | -32768.0 ... 32767.0  | -    | 10 = 1      |
| 14.91  | AO2 source max         | <i>Real</i>       | -32768.0 ... 32767.0  | -    | 10 = 1      |
| 14.92  | AO2 out at AO2 src min | <i>Real</i>       | 0.000 ... 22.000      | mA   | 1000 = 1 mA |
| 14.93  | AO2 out at AO2 src max | <i>Real</i>       | 0.000 ... 22.000      | mA   | 1000 = 1 mA |
| <b>15 I/O extension module 2</b>   |                        |                   |                       |      |             |
| 15.01  | Module 2 type          | <i>List</i>       | 0...4                 | -    | 1 = 1       |
| 15.02  | Module 2 location      | <i>Real</i>       | 1...254               | -    | 1 = 1       |
| 15.03  | Module 2 status        | <i>List</i>       | 0...2                 | -    | 1 = 1       |
| <i>DIx (15.01 Module 2 type = FDIO-01)</i>                                 |                        |                   |                       |      |             |
| 15.05  | DI status              | <i>PB</i>         | 00000000h...FFFFFFFFh | -    | 1 = 1       |
| 15.06  | DI delayed status      | <i>PB</i>         | 00000000h...FFFFFFFFh | -    | 1 = 1       |
| 15.08  | DI filter time         | <i>Real</i>       | 0.8 ... 100.0         | ms   | 10 = 1 ms   |
| 15.12  | DI1 ON delay           | <i>Real</i>       | 0.00 ... 3000.00      | s    | 100 = 1 s   |
| 15.13  | DI1 OFF delay          | <i>Real</i>       | 0.00 ... 3000.00      | s    | 100 = 1 s   |
| 15.17  | DI2 ON delay           | <i>Real</i>       | 0.00 ... 3000.00      | s    | 100 = 1 s   |
| 15.18  | DI2 OFF delay          | <i>Real</i>       | 0.00 ... 3000.00      | s    | 100 = 1 s   |
| 15.22  | DI3 ON delay           | <i>Real</i>       | 0.00 ... 3000.00      | s    | 100 = 1 s   |
| 15.23  | DI3 OFF delay          | <i>Real</i>       | 0.00 ... 3000.00      | s    | 100 = 1 s   |
| <i>Common parameters for DIOx (15.01 Module 2 type = FIO-01 or FIO-11)</i> |                        |                   |                       |      |             |
| 15.05  | DIO status             | <i>PB</i>         | 00000000h...FFFFFFFFh | -    | 1 = 1       |
| 15.06  | DIO delayed status     | <i>PB</i>         | 00000000h...FFFFFFFFh | -    | 1 = 1       |
| <i>DIO1/DIO2 (15.01 Module 2 type = FIO-01 or FIO-11)</i>                  |                        |                   |                       |      |             |
| 15.08  | DIO filter time        | <i>Real</i>       | 0.8 ... 100.0         | ms   | 10 = 1 ms   |
| 15.09  | DIO1 function          | <i>List</i>       | 0...1                 | -    | 1 = 1       |
| 15.11  | DIO1 output source     | <i>Binary src</i> | -                     | -    | 1 = 1       |
| 15.12  | DIO1 ON delay          | <i>Real</i>       | 0.00 ... 3000.00      | s    | 100 = 1 s   |
| 15.13  | DIO1 OFF delay         | <i>Real</i>       | 0.00 ... 3000.00      | s    | 100 = 1 s   |
| 15.14  | DIO2 function          | <i>List</i>       | 0...1                 | -    | 1 = 1       |
| 15.16  | DIO2 output source     | <i>Binary src</i> | -                     | -    | 1 = 1       |
| 15.17  | DIO2 ON delay          | <i>Real</i>       | 0.00 ... 3000.00      | s    | 100 = 1 s   |
| 15.18  | DIO2 OFF delay         | <i>Real</i>       | 0.00 ... 3000.00      | s    | 100 = 1 s   |

| No.  | Name                     | Type       | Range                             | Unit    | FbEq32              |
|--|--------------------------|------------|-----------------------------------|---------|---------------------|
| <i>DIO3/DIO4 (15.01 Module 2 type = FIO-01)</i>                            |                          |            |                                   |         |                     |
| 15.19  | DIO3 function            | List       | 0...1                             | -       | 1 = 1               |
| 15.21  | DIO3 output source       | Binary src | -                                 | -       | 1 = 1               |
| 15.22  | DIO3 ON delay            | Real       | 0.00 ... 3000.00                  | s       | 100 = 1 s           |
| 15.23  | DIO3 OFF delay           | Real       | 0.00 ... 3000.00                  | s       | 100 = 1 s           |
| 15.24  | DIO4 function            | List       | 0...1                             | -       | 1 = 1               |
| 15.26  | DIO4 output source       | Binary src | -                                 | -       | 1 = 1               |
| 15.27  | DIO4 ON delay            | Real       | 0.00 ... 3000.00                  | s       | 100 = 1 s           |
| 15.28  | DIO4 OFF delay           | Real       | 0.00 ... 3000.00                  | s       | 100 = 1 s           |
| <i>RO1/RO2 (15.01 Module 2 type = FIO-01 or FDIO-01)</i>                   |                          |            |                                   |         |                     |
| 15.31  | RO status                | PB         | 0000h...FFFFh                     | -       | 1 = 1               |
| 15.34  | RO1 source               | Binary src | -                                 | -       | 1 = 1               |
| 15.35  | RO1 ON delay             | Real       | 0.00 ... 3000.00                  | s       | 100 = 1 s           |
| 15.36  | RO1 OFF delay            | Real       | 0.00 ... 3000.00                  | s       | 100 = 1 s           |
| 15.37  | RO2 source               | Binary src | -                                 | -       | 1 = 1               |
| 15.38  | RO2 ON delay             | Real       | 0.00 ... 3000.00                  | s       | 100 = 1 s           |
| 15.39  | RO2 OFF delay            | Real       | 0.00 ... 3000.00                  | s       | 100 = 1 s           |
| <i>Common parameters for AIx (15.01 Module 2 type = FIO-11 or FAIO-01)</i> |                          |            |                                   |         |                     |
| 15.19  | AI supervision function  | List       | 0...4                             | -       | 1 = 1               |
| 15.20  | AI supervision selection | PB         | 0000h...FFFFh                     | -       | 1 = 1               |
| 15.21  | AI tune                  | List       | 0...6 (FIO-11)<br>0...4 (FAIO-01) | -       | 1 = 1               |
| 15.22  | AI force selection       | PB         | 00000000h...FFFFFFFFh             | -       | 1 = 1               |
| <i>AI1/AI2 (15.01 Module 2 type = FIO-11 or FAIO-01)</i>                   |                          |            |                                   |         |                     |
| 15.26  | AI1 actual value         | Real       | -22.000 ... 22.000                | mA or V | 1000 = 1 unit       |
| 15.27  | AI1 scaled value         | Real       | -32768.000 ... 32767.000          | -       | 1000 = 1            |
| 15.28  | AI1 force data           | Real       | -22.000 ... 22.000                | mA or V | 1000 = 1 unit       |
| 15.29  | AI1 HW switch position   | List       | -                                 | -       | 1 = 1               |
| 15.30  | AI1 unit selection       | List       | -                                 | -       | 1 = 1               |
| 15.31  | AI1 filter gain          | List       | 0...7                             | -       | 1 = 1               |
| 15.32  | AI1 filter time          | Real       | 0.000 ... 30.000                  | s       | 1000 = 1 s          |
| 15.33  | AI1 min                  | Real       | -22.000 ... 22.000                | mA or V | 1000 = 1 mA<br>or V |
| 15.34  | AI1 max                  | Real       | -22.000 ... 22.000                | mA or V | 1000 = 1 mA<br>or V |
| 15.35  | AI1 scaled at AI1 min    | Real       | -32768.000 ... 32767.000          | -       | 1000 = 1            |
| 15.36  | AI1 scaled at AI1 max    | Real       | -32768.000 ... 32767.000          | -       | 1000 = 1            |
| 15.41  | AI2 actual value         | Real       | -22.000 ... 22.000                | mA or V | 1000 = 1 unit       |
| 15.42  | AI2 scaled value         | Real       | -32768.000 ... 32767.000          | -       | 1000 = 1            |

446 Additional parameter data

| No.  | Name                   | Type              | Range                    | Unit    | FbEq32              |
|--|------------------------|-------------------|--------------------------|---------|---------------------|
| 15.43  | AI2 force data         | <i>Real</i>       | -22.000 ... 22.000       | mA or V | 1000 = 1 unit       |
| 15.44  | AI2 HW switch position | <i>List</i>       | -                        | -       | 1 = 1               |
| 15.45  | AI2 unit selection     | <i>List</i>       | -                        | -       | 1 = 1               |
| 15.46  | AI2 filter gain        | <i>List</i>       | 0...7                    | -       | 1 = 1               |
| 15.47  | AI2 filter time        | <i>Real</i>       | 0.000 ... 30.000         | s       | 1000 = 1 s          |
| 15.48  | AI2 min                | <i>Real</i>       | -22.000 ... 22.000       | mA or V | 1000 = 1 mA<br>or V |
| 15.49  | AI2 max                | <i>Real</i>       | -22.000 ... 22.000       | mA or V | 1000 = 1 mA<br>or V |
| 15.50  | AI2 scaled at AI2 min  | <i>Real</i>       | -32768.000 ... 32767.000 | -       | 1000 = 1            |
| 15.51  | AI2 scaled at AI2 max  | <i>Real</i>       | -32768.000 ... 32767.000 | -       | 1000 = 1            |
| <i>AI3 (15.01 Module 2 type = FIO-11)</i>                                  |                        |                   |                          |         |                     |
| 15.56  | AI3 actual value       | <i>Real</i>       | -22.000 ... 22.000       | mA or V | 1000 = 1 unit       |
| 15.57  | AI3 scaled value       | <i>Real</i>       | -32768.000 ... 32767.000 | -       | 1000 = 1            |
| 15.58  | AI3 force data         | <i>Real</i>       | -22.000 ... 22.000       | mA or V | 1000 = 1 unit       |
| 15.59  | AI3 HW switch position | <i>List</i>       | -                        | -       | 1 = 1               |
| 15.60  | AI3 unit selection     | <i>List</i>       | -                        | -       | 1 = 1               |
| 15.61  | AI3 filter gain        | <i>List</i>       | 0...7                    | -       | 1 = 1               |
| 15.62  | AI3 filter time        | <i>Real</i>       | 0.000 ... 30.000         | s       | 1000 = 1 s          |
| 15.63  | AI3 min                | <i>Real</i>       | -22.000 ... 22.000       | mA or V | 1000 = 1 mA<br>or V |
| 15.64  | AI3 max                | <i>Real</i>       | -22.000 ... 22.000       | mA or V | 1000 = 1 mA<br>or V |
| 15.65  | AI3 scaled at AI3 min  | <i>Real</i>       | -32768.000 ... 32767.000 | -       | 1000 = 1            |
| 15.66  | AI3 scaled at AI3 max  | <i>Real</i>       | -32768.000 ... 32767.000 | -       | 1000 = 1            |
| <i>Common parameters for AOx (15.01 Module 2 type = FIO-11 or FAIO-01)</i> |                        |                   |                          |         |                     |
| 15.71  | AO force selection     | <i>PB</i>         | 00000000h...FFFFFFFFh    | -       | 1 = 1               |
| <i>AO1 (15.01 Module 2 type = FIO-11 or FAIO-01)</i>                       |                        |                   |                          |         |                     |
| 15.76  | AO1 actual value       | <i>Real</i>       | 0.000 ... 22.000         | mA      | 1000 = 1 mA         |
| 15.77  | AO1 source             | <i>Analog src</i> | -                        | -       | 1 = 1               |
| 15.78  | AO1 force data         | <i>Real</i>       | 0.000 ... 22.000         | mA      | 1000 = 1 mA         |
| 15.79  | AO1 filter time        | <i>Real</i>       | 0.000 ... 30.000         | s       | 1000 = 1 s          |
| 15.80  | AO1 source min         | <i>Real</i>       | -32768.0 ... 32767.0     | -       | 10 = 1              |
| 15.81  | AO1 source max         | <i>Real</i>       | -32768.0 ... 32767.0     | -       | 10 = 1              |
| 15.82  | AO1 out at AO1 src min | <i>Real</i>       | 0.000 ... 22.000         | mA      | 1000 = 1 mA         |
| 15.83  | AO1 out at AO1 src max | <i>Real</i>       | 0.000 ... 22.000         | mA      | 1000 = 1 mA         |
| <i>AO2 (15.01 Module 2 type = FAIO-01)</i>                                 |                        |                   |                          |         |                     |
| 15.86  | AO2 actual value       | <i>Real</i>       | 0.000 ... 22.000         | mA      | 1000 = 1 mA         |
| 15.87  | AO2 source             | <i>Analog src</i> | -                        | -       | 1 = 1               |
| 15.88  | AO2 force data         | <i>Real</i>       | 0.000 ... 22.000         | mA      | 1000 = 1 mA         |
| 15.89  | AO2 filter time        | <i>Real</i>       | 0.000 ... 30.000         | s       | 1000 = 1 s          |

| No.  | Name                   | Type              | Range                 | Unit | FbEq32      |
|--|------------------------|-------------------|-----------------------|------|-------------|
| 15.90  | AO2 source min         | <i>Real</i>       | -32768.0 ... 32767.0  | -    | 10 = 1      |
| 15.91  | AO2 source max         | <i>Real</i>       | -32768.0 ... 32767.0  | -    | 10 = 1      |
| 15.92  | AO2 out at AO2 src min | <i>Real</i>       | 0.000 ... 22.000      | mA   | 1000 = 1 mA |
| 15.93  | AO2 out at AO2 src max | <i>Real</i>       | 0.000 ... 22.000      | mA   | 1000 = 1 mA |
| <b>16 I/O extension module 3</b>   |                        |                   |                       |      |             |
| 16.01  | Module 3 type          | <i>List</i>       | 0...4                 | -    | 1 = 1       |
| 16.02  | Module 3 location      | <i>Real</i>       | 1...254               | -    | 1 = 1       |
| 16.03  | Module 3 status        | <i>List</i>       | 0...2                 | -    | 1 = 1       |
| <i>Dlx (16.01 Module 3 type = FDIO-01)</i>                                 |                        |                   |                       |      |             |
| 16.05  | DI status              | <i>PB</i>         | 00000000h...FFFFFFFFh | -    | 1 = 1       |
| 16.06  | DI delayed status      | <i>PB</i>         | 00000000h...FFFFFFFFh | -    | 1 = 1       |
| 16.08  | DI filter time         | <i>Real</i>       | 0.8 ... 100.0         | ms   | 10 = 1 ms   |
| 16.12  | DI1 ON delay           | <i>Real</i>       | 0.00 ... 3000.00      | s    | 100 = 1 s   |
| 16.13  | DI1 OFF delay          | <i>Real</i>       | 0.00 ... 3000.00      | s    | 100 = 1 s   |
| 16.17  | DI2 ON delay           | <i>Real</i>       | 0.00 ... 3000.00      | s    | 100 = 1 s   |
| 16.18  | DI2 OFF delay          | <i>Real</i>       | 0.00 ... 3000.00      | s    | 100 = 1 s   |
| 16.22  | DI3 ON delay           | <i>Real</i>       | 0.00 ... 3000.00      | s    | 100 = 1 s   |
| 16.23  | DI3 OFF delay          | <i>Real</i>       | 0.00 ... 3000.00      | s    | 100 = 1 s   |
| <i>Common parameters for DIOx (16.01 Module 3 type = FIO-01 or FIO-11)</i> |                        |                   |                       |      |             |
| 16.05  | DIO status             | <i>PB</i>         | 00000000h...FFFFFFFFh | -    | 1 = 1       |
| 16.06  | DIO delayed status     | <i>PB</i>         | 00000000h...FFFFFFFFh | -    | 1 = 1       |
| <i>DIO1/DIO2 (16.01 Module 3 type = FIO-01 or FIO-11)</i>                  |                        |                   |                       |      |             |
| 16.08  | DIO filter time        | <i>Real</i>       | 0.8 ... 100.0         | ms   | 10 = 1 ms   |
| 16.09  | DIO1 function          | <i>List</i>       | 0...1                 | -    | 1 = 1       |
| 16.11  | DIO1 output source     | <i>Binary src</i> | -                     | -    | 1 = 1       |
| 16.12  | DIO1 ON delay          | <i>Real</i>       | 0.00 ... 3000.00      | s    | 100 = 1 s   |
| 16.13  | DIO1 OFF delay         | <i>Real</i>       | 0.00 ... 3000.00      | s    | 100 = 1 s   |
| 16.14  | DIO2 function          | <i>List</i>       | 0...1                 | -    | 1 = 1       |
| 16.16  | DIO2 output source     | <i>Binary src</i> | -                     | -    | 1 = 1       |
| 16.17  | DIO2 ON delay          | <i>Real</i>       | 0.00 ... 3000.00      | s    | 100 = 1 s   |
| 16.18  | DIO2 OFF delay         | <i>Real</i>       | 0.00 ... 3000.00      | s    | 100 = 1 s   |
| <i>DIO3/DIO4 (16.01 Module 3 type = FIO-01)</i>                            |                        |                   |                       |      |             |
| 16.19  | DIO3 function          | <i>List</i>       | 0...1                 | -    | 1 = 1       |
| 16.21  | DIO3 output source     | <i>Binary src</i> | -                     | -    | 1 = 1       |
| 16.22  | DIO3 ON delay          | <i>Real</i>       | 0.00 ... 3000.00      | s    | 100 = 1 s   |
| 16.23  | DIO3 OFF delay         | <i>Real</i>       | 0.00 ... 3000.00      | s    | 100 = 1 s   |
| 16.24  | DIO4 function          | <i>List</i>       | 0...1                 | -    | 1 = 1       |
| 16.26  | DIO4 output source     | <i>Binary src</i> | -                     | -    | 1 = 1       |

448 Additional parameter data

| No.  | Name                     | Type              | Range   | Unit    | FbEq32              |
|--|--------------------------|-------------------|---|---------|---------------------|
| 16.27  | DIO4 ON delay            | <i>Real</i>       | 0.00 ... 3000.00                                    | s       | 100 = 1 s           |
| 16.28  | DIO4 OFF delay           | <i>Real</i>       | 0.00 ... 3000.00                                    | s       | 100 = 1 s           |
| <i>RO1/RO2 (16.01 Module 3 type = FIO-01 or FDIO-01)</i>                   |                          |                   |   |         |                     |
| 16.31  | RO status                | <i>PB</i>         | 0000h...FFFFh                                       | -       | 1 = 1               |
| 16.34  | RO1 source               | <i>Binary src</i> | -   | -       | 1 = 1               |
| 16.35  | RO1 ON delay             | <i>Real</i>       | 0.00 ... 3000.00                                    | s       | 100 = 1 s           |
| 16.36  | RO1 OFF delay            | <i>Real</i>       | 0.00 ... 3000.00                                    | s       | 100 = 1 s           |
| 16.37  | RO2 source               | <i>Binary src</i> | -   | -       | 1 = 1               |
| 16.38  | RO2 ON delay             | <i>Real</i>       | 0.00 ... 3000.00                                    | s       | 100 = 1 s           |
| 16.39  | RO2 OFF delay            | <i>Real</i>       | 0.00 ... 3000.00                                    | s       | 100 = 1 s           |
| <i>Common parameters for AIx (16.01 Module 3 type = FIO-11 or FAIO-01)</i> |                          |                   |   |         |                     |
| 16.19  | AI supervision function  | <i>List</i>       | 0...4   | -       | 1 = 1               |
| 16.20  | AI supervision selection | <i>PB</i>         | 0000h...FFFFh                                       | -       | 1 = 1               |
| 16.21  | AI tune                  | <i>List</i>       | 0...6 ( <i>FIO-11</i> )<br>0...4 ( <i>FAIO-01</i> ) | -       | 1 = 1               |
| 16.22  | AI force selection       | <i>PB</i>         | 00000000h...FFFFFFFFh                               | -       | 1 = 1               |
| <i>AI1/AI2 (16.01 Module 3 type = FIO-11 or FAIO-01)</i>                   |                          |                   |   |         |                     |
| 16.26  | AI1 actual value         | <i>Real</i>       | -22.000 ... 22.000                                  | mA or V | 1000 = 1 unit       |
| 16.27  | AI1 scaled value         | <i>Real</i>       | -32768.000 ... 32767.000                            | -       | 1000 = 1            |
| 16.28  | AI1 force data           | <i>Real</i>       | -22.000 ... 22.000                                  | mA or V | 1000 = 1 unit       |
| 16.29  | AI1 HW switch position   | <i>List</i>       | -   | -       | 1 = 1               |
| 16.30  | AI1 unit selection       | <i>List</i>       | -   | -       | 1 = 1               |
| 16.31  | AI1 filter gain          | <i>List</i>       | 0...7   | -       | 1 = 1               |
| 16.32  | AI1 filter time          | <i>Real</i>       | 0.000 ... 30.000                                    | s       | 1000 = 1 s          |
| 16.33  | AI1 min                  | <i>Real</i>       | -22.000 ... 22.000                                  | mA or V | 1000 = 1 mA<br>or V |
| 16.34  | AI1 max                  | <i>Real</i>       | -22.000 ... 22.000                                  | mA or V | 1000 = 1 mA<br>or V |
| 16.35  | AI1 scaled at AI1 min    | <i>Real</i>       | -32768.000 ... 32767.000                            | -       | 1000 = 1            |
| 16.36  | AI1 scaled at AI1 max    | <i>Real</i>       | -32768.000 ... 32767.000                            | -       | 1000 = 1            |
| 16.41  | AI2 actual value         | <i>Real</i>       | -22.000 ... 22.000                                  | mA or V | 1000 = 1 unit       |
| 16.42  | AI2 scaled value         | <i>Real</i>       | -32768.000 ... 32767.000                            | -       | 1000 = 1            |
| 16.43  | AI2 force data           | <i>Real</i>       | -22.000 ... 22.000                                  | mA or V | 1000 = 1 unit       |
| 16.44  | AI2 HW switch position   | <i>List</i>       | -   | -       | 1 = 1               |
| 16.45  | AI2 unit selection       | <i>List</i>       | -   | -       | 1 = 1               |
| 16.46  | AI2 filter gain          | <i>List</i>       | 0...7   | -       | 1 = 1               |
| 16.47  | AI2 filter time          | <i>Real</i>       | 0.000 ... 30.000                                    | s       | 1000 = 1 s          |
| 16.48  | AI2 min                  | <i>Real</i>       | -22.000 ... 22.000                                  | mA or V | 1000 = 1 mA<br>or V |
| 16.49  | AI2 max                  | <i>Real</i>       | -22.000 ... 22.000                                  | mA or V | 1000 = 1 mA<br>or V |



| No.  | Name                   | Type              | Range                    | Unit    | FbEq32              |
|--|------------------------|-------------------|--------------------------|---------|---------------------|
| 16.50  | AI2 scaled at AI2 min  | <i>Real</i>       | -32768.000 ... 32767.000 | -       | 1000 = 1            |
| 16.51  | AI2 scaled at AI2 max  | <i>Real</i>       | -32768.000 ... 32767.000 | -       | 1000 = 1            |
| <i>AI3 (16.01 Module 3 type = FIO-11)</i>                                  |                        |                   |                          |         |                     |
| 16.56  | AI3 actual value       | <i>Real</i>       | -22.000 ... 22.000       | mA or V | 1000 = 1 unit       |
| 16.57  | AI3 scaled value       | <i>Real</i>       | -32768.000 ... 32767.000 | -       | 1000 = 1            |
| 16.58  | AI3 force data         | <i>Real</i>       | -22.000 ... 22.000       | mA or V | 1000 = 1 unit       |
| 16.59  | AI3 HW switch position | <i>List</i>       | -                        | -       | 1 = 1               |
| 16.60  | AI3 unit selection     | <i>List</i>       | -                        | -       | 1 = 1               |
| 16.61  | AI3 filter gain        | <i>List</i>       | 0...7                    | -       | 1 = 1               |
| 16.62  | AI3 filter time        | <i>Real</i>       | 0.000 ... 30.000         | s       | 1000 = 1 s          |
| 16.63  | AI3 min                | <i>Real</i>       | -22.000 ... 22.000       | mA or V | 1000 = 1 mA<br>or V |
| 16.64  | AI3 max                | <i>Real</i>       | -22.000 ... 22.000       | mA or V | 1000 = 1 mA<br>or V |
| 16.65  | AI3 scaled at AI3 min  | <i>Real</i>       | -32768.000 ... 32767.000 | -       | 1000 = 1            |
| 16.66  | AI3 scaled at AI3 max  | <i>Real</i>       | -32768.000 ... 32767.000 | -       | 1000 = 1            |
| <i>Common parameters for AOx (16.01 Module 3 type = FIO-11 or FAIO-01)</i> |                        |                   |                          |         |                     |
| 16.71  | AO force selection     | <i>PB</i>         | 00000000h...FFFFFFFFh    | -       | 1 = 1               |
| <i>AO1 (16.01 Module 3 type = FIO-11 or FAIO-01)</i>                       |                        |                   |                          |         |                     |
| 16.76  | AO1 actual value       | <i>Real</i>       | 0.000 ... 22.000         | mA      | 1000 = 1 mA         |
| 16.77  | AO1 source             | <i>Analog src</i> | -                        | -       | 1 = 1               |
| 16.78  | AO1 force data         | <i>Real</i>       | 0.000 ... 22.000         | mA      | 1000 = 1 mA         |
| 16.79  | AO1 filter time        | <i>Real</i>       | 0.000 ... 30.000         | s       | 1000 = 1 s          |
| 16.80  | AO1 source min         | <i>Real</i>       | -32768.0 ... 32767.0     | -       | 10 = 1              |
| 16.81  | AO1 source max         | <i>Real</i>       | -32768.0 ... 32767.0     | -       | 10 = 1              |
| 16.82  | AO1 out at AO1 src min | <i>Real</i>       | 0.000 ... 22.000         | mA      | 1000 = 1 mA         |
| 16.83  | AO1 out at AO1 src max | <i>Real</i>       | 0.000 ... 22.000         | mA      | 1000 = 1 mA         |
| <i>AO2 (16.01 Module 3 type = FAIO-01)</i>                                 |                        |                   |                          |         |                     |
| 16.86  | AO2 actual value       | <i>Real</i>       | 0.000 ... 22.000         | mA      | 1000 = 1 mA         |
| 16.87  | AO2 source             | <i>Analog src</i> | -                        | -       | 1 = 1               |
| 16.88  | AO2 force data         | <i>Real</i>       | 0.000 ... 22.000         | mA      | 1000 = 1 mA         |
| 16.89  | AO2 filter time        | <i>Real</i>       | 0.000 ... 30.000         | s       | 1000 = 1 s          |
| 16.90  | AO2 source min         | <i>Real</i>       | -32768.0 ... 32767.0     | -       | 10 = 1              |
| 16.91  | AO2 source max         | <i>Real</i>       | -32768.0 ... 32767.0     | -       | 10 = 1              |
| 16.92  | AO2 out at AO2 src min | <i>Real</i>       | 0.000 ... 22.000         | mA      | 1000 = 1 mA         |
| 16.93  | AO2 out at AO2 src max | <i>Real</i>       | 0.000 ... 22.000         | mA      | 1000 = 1 mA         |
| <b>19 Operation mode</b>   |                        |                   |                          |         |                     |
| 19.01  | Actual operation mode  | <i>List</i>       | -                        | -       | 1 = 1               |
| 19.11  | Ext1/Ext2 selection    | <i>Binary src</i> | -                        | -       | 1 = 1               |
| 19.12  | Ext1 control mode      | <i>List</i>       | 1...6                    | -       | 1 = 1               |

## 450 Additional parameter data

| No.                            | Name                            | Type              | Range     | Unit | FbEq32   |
|--------------------------------|---------------------------------|-------------------|-----------|------|----------|
| 19.14                          | Ext2 control mode               | <i>List</i>       | 1...6     | -    | 1 = 1    |
| 19.16                          | Local control mode              | <i>List</i>       | 0...1     | -    | 1 = 1    |
| 19.17                          | Local control disable           | <i>List</i>       | 0...1     | -    | 1 = 1    |
| 19.20                          | Scalar control reference unit   | <i>List</i>       | 0...1     | -    | 1 = 1    |
| <b>20 Start/stop/direction</b> |                                 |                   |           |      |          |
| 20.01                          | Ext1 commands                   | <i>List</i>       | -         | -    | 1 = 1    |
| 20.02                          | Ext1 start trigger type         | <i>List</i>       | 0...1     | -    | 1 = 1    |
| 20.03                          | Ext1 in1 source                 | <i>Binary src</i> | -         | -    | 1 = 1    |
| 20.04                          | Ext1 in2 source                 | <i>Binary src</i> | -         | -    | 1 = 1    |
| 20.05                          | Ext1 in3 source                 | <i>Binary src</i> | -         | -    | 1 = 1    |
| 20.06                          | Ext2 commands                   | <i>List</i>       | -         | -    | 1 = 1    |
| 20.07                          | Ext2 start trigger type         | <i>List</i>       | 0...1     | -    | 1 = 1    |
| 20.08                          | Ext2 in1 source                 | <i>Binary src</i> | -         | -    | 1 = 1    |
| 20.09                          | Ext2 in2 source                 | <i>Binary src</i> | -         | -    | 1 = 1    |
| 20.10                          | Ext2 in3 source                 | <i>Binary src</i> | -         | -    | 1 = 1    |
| 20.11                          | Run enable stop mode            | <i>List</i>       | 0...2     | -    | 1 = 1    |
| 20.12                          | Run enable 1 source             | <i>Binary src</i> | -         | -    | 1 = 1    |
| 20.19                          | Enable start command            | <i>Binary src</i> | -         | -    | 1 = 1    |
| 20.23                          | Positive speed enable           | <i>Binary src</i> | -         | -    | 1 = 1    |
| 20.24                          | Negative speed enable           | <i>Binary src</i> | -         | -    | 1 = 1    |
| 20.25                          | Jogging enable                  | <i>Binary src</i> | -         | -    | 1 = 1    |
| 20.26                          | Jogging 1 start source          | <i>Binary src</i> | -         | -    | 1 = 1    |
| 20.27                          | Jogging 2 start source          | <i>Binary src</i> | -         | -    | 1 = 1    |
| 20.29                          | Local start trigger type        | <i>List</i>       | 0...1     | -    | 1 = 1    |
| 20.30                          | Enable signals warning function | <i>PB</i>         | 00b...11b | -    | 1 = 1    |
| <b>21 Start/stop mode</b>      |                                 |                   |           |      |          |
| 21.01                          | Start mode                      | <i>List</i>       | 0...3     | -    | 1 = 1    |
| 21.02                          | Magnetization time              | <i>Real</i>       | 0...10000 | ms   | 1 = 1 ms |
| 21.03                          | Stop mode                       | <i>List</i>       | 0...2     | -    | 1 = 1    |
| 21.04                          | Emergency stop mode             | <i>List</i>       | 0...2     | -    | 1 = 1    |
| 21.05                          | Emergency stop source           | <i>Binary src</i> | -         | -    | 1 = 1    |

| No.                                 | Name                             | Type              | Range                  | Unit | FbEq32      |
|-------------------------------------|----------------------------------|-------------------|------------------------|------|-------------|
| 21.06                               | Zero speed limit                 | <i>Real</i>       | 0.00 ... 30000.00      | rpm  | 100 = 1 rpm |
| 21.07                               | Zero speed delay                 | <i>Real</i>       | 0...30000              | ms   | 1 = 1 ms    |
| 21.08                               | DC current control               | <i>PB</i>         | 00b...11b              | -    | 1 = 1       |
| 21.09                               | DC hold speed                    | <i>Real</i>       | 0.00 ... 1000.00       | rpm  | 100 = 1 rpm |
| 21.10                               | DC current reference             | <i>Real</i>       | 0.0 ... 100.0          | %    | 10 = 1%     |
| 21.11                               | Post magnetization time          | <i>Real</i>       | 0...3000               | s    | 1 = 1 s     |
| 21.12                               | Continuous magnetization command | <i>Binary src</i> | -                      | -    | 1 = 1       |
| 21.13                               | Autophasing mode                 | <i>List</i>       | 0...3                  | -    | 1 = 1       |
| 21.14                               | Pre-heating input source         | <i>Binary src</i> | -                      | -    | 1 = 1       |
| 21.16                               | Pre-heating current              | <i>Real</i>       | 0.0 ... 30.0           | %    | 10 = 1%     |
| 21.18                               | Auto restart time                | <i>Real</i>       | 0.0, 0.1 ... 5.0       | s    | 10 = 1 s    |
| 21.19                               | Scalar start mode                | <i>List</i>       | 0...2                  | -    | 1 = 1       |
| 21.20                               | Follower force ramp stop         | <i>Binary src</i> | -                      | -    | 1 = 1       |
| <b>22 Speed reference selection</b> |                                  |                   |                        |      |             |
| 22.01                               | Speed ref unlimited              | <i>Real</i>       | -30000.00 ... 30000.00 | rpm  | 100 = 1 rpm |
| 22.11                               | Speed ref1 source                | <i>Analog src</i> | -                      | -    | 1 = 1       |
| 22.12                               | Speed ref2 source                | <i>Analog src</i> | -                      | -    | 1 = 1       |
| 22.13                               | Speed ref1 function              | <i>List</i>       | 0...5                  | -    | 1 = 1       |
| 22.14                               | Speed ref1/2 selection           | <i>Binary src</i> | -                      | -    | 1 = 1       |
| 22.15                               | Speed additive 1 source          | <i>Analog src</i> | -                      | -    | 1 = 1       |
| 22.16                               | Speed share                      | <i>Real</i>       | -8.000 ... 8.000       | -    | 1000 = 1    |
| 22.17                               | Speed additive 2 source          | <i>Analog src</i> | -                      | -    | 1 = 1       |
| 22.21                               | Constant speed function          | <i>PB</i>         | 00b...11b              | -    | 1 = 1       |
| 22.22                               | Constant speed sel1              | <i>Binary src</i> | -                      | -    | 1 = 1       |
| 22.23                               | Constant speed sel2              | <i>Binary src</i> | -                      | -    | 1 = 1       |
| 22.24                               | Constant speed sel3              | <i>Binary src</i> | -                      | -    | 1 = 1       |
| 22.26                               | Constant speed 1                 | <i>Real</i>       | -30000.00 ... 30000.00 | rpm  | 100 = 1 rpm |
| 22.27                               | Constant speed 2                 | <i>Real</i>       | -30000.00 ... 30000.00 | rpm  | 100 = 1 rpm |
| 22.28                               | Constant speed 3                 | <i>Real</i>       | -30000.00 ... 30000.00 | rpm  | 100 = 1 rpm |
| 22.29                               | Constant speed 4                 | <i>Real</i>       | -30000.00 ... 30000.00 | rpm  | 100 = 1 rpm |
| 22.30                               | Constant speed 5                 | <i>Real</i>       | -30000.00 ... 30000.00 | rpm  | 100 = 1 rpm |
| 22.31                               | Constant speed 6                 | <i>Real</i>       | -30000.00 ... 30000.00 | rpm  | 100 = 1 rpm |
| 22.32                               | Constant speed 7                 | <i>Real</i>       | -30000.00 ... 30000.00 | rpm  | 100 = 1 rpm |
| 22.41                               | Speed ref safe                   | <i>Real</i>       | -30000.00 ... 30000.00 | rpm  | 100 = 1 rpm |

## 452 Additional parameter data

| No.                            | Name                              | Type              | Range                  | Unit | FbEq32      |
|--------------------------------|-----------------------------------|-------------------|------------------------|------|-------------|
| 22.42                          | Jogging 1 ref                     | <i>Real</i>       | -30000.00 ... 30000.00 | rpm  | 100 = 1 rpm |
| 22.43                          | Jogging 2 ref                     | <i>Real</i>       | -30000.00 ... 30000.00 | rpm  | 100 = 1 rpm |
| 22.51                          | Critical speed function           | <i>PB</i>         | 00b...11b              | -    | 1 = 1       |
| 22.52                          | Critical speed 1 low              | <i>Real</i>       | -30000.00 ... 30000.00 | rpm  | 100 = 1 rpm |
| 22.53                          | Critical speed 1 high             | <i>Real</i>       | -30000.00 ... 30000.00 | rpm  | 100 = 1 rpm |
| 22.54                          | Critical speed 2 low              | <i>Real</i>       | -30000.00 ... 30000.00 | rpm  | 100 = 1 rpm |
| 22.55                          | Critical speed 2 high             | <i>Real</i>       | -30000.00 ... 30000.00 | rpm  | 100 = 1 rpm |
| 22.56                          | Critical speed 3 low              | <i>Real</i>       | -30000.00 ... 30000.00 | rpm  | 100 = 1 rpm |
| 22.57                          | Critical speed 3 high             | <i>Real</i>       | -30000.00 ... 30000.00 | rpm  | 100 = 1 rpm |
| 22.71                          | Motor potentiometer function      | <i>List</i>       | 0...2                  | -    | 1 = 1       |
| 22.72                          | Motor potentiometer initial value | <i>Real</i>       | -32768.00 ... 32767.00 | -    | 100 = 1     |
| 22.73                          | Motor potentiometer up source     | <i>Binary src</i> | -                      | -    | 1 = 1       |
| 22.74                          | Motor potentiometer down source   | <i>Binary src</i> | -                      | -    | 1 = 1       |
| 22.75                          | Motor potentiometer ramp time     | <i>Real</i>       | 0.0 ... 3600.0         | s    | 10 = 1 s    |
| 22.76                          | Motor potentiometer min value     | <i>Real</i>       | -32768.00 ... 32767.00 | -    | 100 = 1     |
| 22.77                          | Motor potentiometer max value     | <i>Real</i>       | -32768.00 ... 32767.00 | -    | 100 = 1     |
| 22.80                          | Motor potentiometer ref act       | <i>Real</i>       | -32768.00 ... 32767.00 | -    | 100 = 1     |
| 22.81                          | Speed reference act 1             | <i>Real</i>       | -30000.00 ... 30000.00 | rpm  | 100 = 1 rpm |
| 22.82                          | Speed reference act 2             | <i>Real</i>       | -30000.00 ... 30000.00 | rpm  | 100 = 1 rpm |
| 22.83                          | Speed reference act 3             | <i>Real</i>       | -30000.00 ... 30000.00 | rpm  | 100 = 1 rpm |
| 22.84                          | Speed reference act 4             | <i>Real</i>       | -30000.00 ... 30000.00 | rpm  | 100 = 1 rpm |
| 22.85                          | Speed reference act 5             | <i>Real</i>       | -30000.00 ... 30000.00 | rpm  | 100 = 1 rpm |
| 22.86                          | Speed reference act 6             | <i>Real</i>       | -30000.00 ... 30000.00 | rpm  | 100 = 1 rpm |
| 22.87                          | Speed reference act 7             | <i>Real</i>       | -30000.00 ... 30000.00 | rpm  | 100 = 1 rpm |
| <b>23 Speed reference ramp</b> |                                   |                   |                        |      |             |
| 23.01                          | Speed ref ramp input              | <i>Real</i>       | -30000.00 ... 30000.00 | rpm  | 100 = 1 rpm |
| 23.02                          | Speed ref ramp output             | <i>Real</i>       | -30000.00 ... 30000.00 | rpm  | 100 = 1 rpm |
| 23.11                          | Ramp set selection                | <i>Binary src</i> | -                      | -    | 1 = 1       |
| 23.12                          | Acceleration time 1               | <i>Real</i>       | 0.000 ... 1800.000     | s    | 1000 = 1 s  |
| 23.13                          | Deceleration time 1               | <i>Real</i>       | 0.000 ... 1800.000     | s    | 1000 = 1 s  |
| 23.14                          | Acceleration time 2               | <i>Real</i>       | 0.000 ... 1800.000     | s    | 1000 = 1 s  |
| 23.15                          | Deceleration time 2               | <i>Real</i>       | 0.000 ... 1800.000     | s    | 1000 = 1 s  |
| 23.16                          | Shape time acc 1                  | <i>Real</i>       | 0.000 ... 1800.000     | s    | 1000 = 1 s  |
| 23.17                          | Shape time acc 2                  | <i>Real</i>       | 0.000 ... 1800.000     | s    | 1000 = 1 s  |
| 23.18                          | Shape time dec 1                  | <i>Real</i>       | 0.000 ... 1800.000     | s    | 1000 = 1 s  |
| 23.19                          | Shape time dec 2                  | <i>Real</i>       | 0.000 ... 1800.000     | s    | 1000 = 1 s  |
| 23.20                          | Acc time jogging                  | <i>Real</i>       | 0.000 ... 1800.000     | s    | 1000 = 1 s  |
| 23.21                          | Dec time jogging                  | <i>Real</i>       | 0.000 ... 1800.000     | s    | 1000 = 1 s  |

| No.                                    | Name                              | Type              | Range                  | Unit | FbEq32      |
|--|-----------------------------------|-------------------|------------------------|------|-------------|
| 23.23                                  | Emergency stop time               | <i>Real</i>       | 0.000 ... 1800.000     | s    | 1000 = 1 s  |
| 23.24                                  | Speed ramp in zero source         | <i>Binary src</i> | -                      | -    | 1 = 1       |
| 23.26                                  | Ramp out balancing enable         | <i>Binary src</i> | -                      | -    | 1 = 1       |
| 23.27                                  | Ramp out balancing ref            | <i>Real</i>       | -30000.00 ... 30000.00 | rpm  | 100 = 1 rpm |
| 23.28                                  | Variable slope enable             | <i>List</i>       | 0...1                  | -    | 1 = 1       |
| 23.29                                  | Variable slope rate               | <i>Real</i>       | 2...30000              | ms   | 1 = 1 ms    |
| 23.39                                  | Follower speed correction out     | <i>Real</i>       | -30000.00 ... 30000.00 | rpm  | 100 = 1 rpm |
| 23.40                                  | Follower speed correction enable  | <i>Binary src</i> | -                      | -    | 1 = 1       |
| 23.41                                  | Follower speed correction gain    | <i>Real</i>       | 0.00 ... 100.00        | %    | 100 = 1%    |
| 23.42                                  | Follower speed corr torq source   | <i>Analog src</i> | -                      | -    | 1 = 1       |
| <b>24 Speed reference conditioning</b> |                                   |                   |                        |      |             |
| 24.01                                  | Used speed reference              | <i>Real</i>       | -30000.00 ... 30000.00 | rpm  | 100 = 1 rpm |
| 24.02                                  | Used speed feedback               | <i>Real</i>       | -30000.00 ... 30000.00 | rpm  | 100 = 1 rpm |
| 24.03                                  | Speed error filtered              | <i>Real</i>       | -30000.0 ... 30000.0   | rpm  | 100 = 1 rpm |
| 24.04                                  | Speed error inverted              | <i>Real</i>       | -30000.0 ... 30000.0   | rpm  | 100 = 1 rpm |
| 24.11                                  | Speed correction                  | <i>Real</i>       | -10000.00 ... 10000.00 | rpm  | 100 = 1 rpm |
| 24.12                                  | Speed error filter time           | <i>Real</i>       | 0...10000              | ms   | 1 = 1 ms    |
| 24.13                                  | RFE speed filter                  | <i>List</i>       | 0...1                  | -    | 1 = 1       |
| 24.14                                  | Frequency of zero                 | <i>Real</i>       | 0.50 ... 500.00        | Hz   | 10 = 1 Hz   |
| 24.15                                  | Damping of zero                   | <i>Real</i>       | -1.000 ... 1.000       | -    | 100 = 1     |
| 24.16                                  | Frequency of pole                 | <i>Real</i>       | 0.50 ... 500.00        | Hz   | 10 = 1 Hz   |
| 24.17                                  | Damping of pole                   | <i>Real</i>       | -1.000 ... 1.000       | -    | 100 = 1     |
| 24.41                                  | Speed error window control enable | <i>Binary src</i> | -                      | -    | 1 = 1       |
| 24.42                                  | Speed window control mode         | <i>List</i>       | 0...1                  | -    | 1 = 1       |
| 24.43                                  | Speed error window high           | <i>Real</i>       | 0.00 ... 3000.00       | rpm  | 100 = 1 rpm |
| 24.44                                  | Speed error window low            | <i>Real</i>       | 0.00 ... 3000.00       | rpm  | 100 = 1 rpm |
| 24.46                                  | Speed error step                  | <i>Real</i>       | -3000.00 ... 3000.00   | rpm  | 100 = 1 rpm |
| <b>25 Speed control</b>                |                                   |                   |                        |      |             |
| 25.01                                  | Torque reference speed control    | <i>Real</i>       | -1600.0 ... 1600.0     | %    | 10 = 1%     |
| 25.02                                  | Speed proportional gain           | <i>Real</i>       | 0.00 ... 250.00        | -    | 100 = 1     |
| 25.03                                  | Speed integration time            | <i>Real</i>       | 0.00 ... 1000.00       | s    | 100 = 1 s   |
| 25.04                                  | Speed derivation time             | <i>Real</i>       | 0.000 ... 10.000       | s    | 1000 = 1 s  |
| 25.05                                  | Derivation filter time            | <i>Real</i>       | 0...10000              | ms   | 1 = 1 ms    |
| 25.06                                  | Acc comp derivation time          | <i>Real</i>       | 0.00 ... 1000.00       | s    | 100 = 1 s   |
| 25.07                                  | Acc comp filter time              | <i>Real</i>       | 0.0 ... 1000.0         | ms   | 10 = 1 ms   |
| 25.08                                  | Drooping rate                     | <i>Real</i>       | 0.00 ... 100.00        | %    | 100 = 1%    |

## 454 Additional parameter data

| No.                              | Name                           | Type              | Range                | Unit | FbEq32     |
|----------------------------------|--------------------------------|-------------------|----------------------|------|------------|
| 25.09                            | Speed ctrl balancing enable    | <i>Binary src</i> | -                    | -    | 1 = 1      |
| 25.10                            | Speed ctrl balancing ref       | <i>Real</i>       | -300.0 ... 300.0     | %    | 10 = 1%    |
| 25.11                            | Speed control min torque       | <i>Real</i>       | -1600.0 ... 0.0      | %    | 10 = 1%    |
| 25.12                            | Speed control max torque       | <i>Real</i>       | 0.0 ... 1600.0       | %    | 10 = 1%    |
| 25.13                            | Min torq sp ctrl em stop       | <i>Real</i>       | -1600 ... 0          | %    | 10 = 1%    |
| 25.14                            | Max torq sp ctrl em stop       | <i>Real</i>       | 0...1600             | %    | 10 = 1%    |
| 25.15                            | Proportional gain em stop      | <i>Real</i>       | 1.00 ... 250.00      | -    | 100 = 1    |
| 25.18                            | Speed adapt min limit          | <i>Real</i>       | 0...30000            | rpm  | 1 = 1 rpm  |
| 25.19                            | Speed adapt max limit          | <i>Real</i>       | 0...30000            | rpm  | 1 = 1 rpm  |
| 25.21                            | Kp adapt coef at min speed     | <i>Real</i>       | 0.000 ... 10.000     | -    | 1000 = 1   |
| 25.22                            | Ti adapt coef at min speed     | <i>Real</i>       | 0.000 ... 10.000     | -    | 1000 = 1   |
| 25.25                            | Torque adapt max limit         | <i>Real</i>       | 0.0 ... 1600.0       | %    | 10 = 1%    |
| 25.26                            | Torque adapt filt time         | <i>Real</i>       | 0.000 ... 100.000    | s    | 1000 = 1 s |
| 25.27                            | Kp adapt coef at min torque    | <i>Real</i>       | 0.000 ... 10.000     | -    | 1000 = 1   |
| 25.30                            | Flux adaption enable           | <i>List</i>       | 0...1                | -    | 1 = 1      |
| 25.33                            | Speed controller autotune      | <i>Binary src</i> | -                    | -    | 1 = 1      |
| 25.34                            | Speed controller autotune mode | <i>List</i>       | 0...2                | -    | 1 = 1      |
| 25.37                            | Mechanical time constant       | <i>Real</i>       | 0.00 ... 1000.00     | s    | 100 = 1 s  |
| 25.38                            | Autotune torque step           | <i>Real</i>       | 0.00 ... 100.00      | %    | 100 = 1%   |
| 25.39                            | Autotune speed step            | <i>Real</i>       | 0.00 ... 100.00      | %    | 100 = 1%   |
| 25.40                            | Autotune repeat times          | <i>Real</i>       | 1...10               | -    | 1 = 1      |
| 25.53                            | Torque prop reference          | <i>Real</i>       | -30000.0 ... 30000.0 | %    | 10 = 1%    |
| 25.54                            | Torque integral reference      | <i>Real</i>       | -30000.0 ... 30000.0 | %    | 10 = 1%    |
| 25.55                            | Torque deriv reference         | <i>Real</i>       | -30000.0 ... 30000.0 | %    | 10 = 1%    |
| 25.56                            | Torque acc compensation        | <i>Real</i>       | -30000.0 ... 30000.0 | %    | 10 = 1%    |
| 25.57                            | Torque reference unbalanced    | <i>Real</i>       | -30000.0 ... 30000.0 | %    | 10 = 1%    |
| <b>26 Torque reference chain</b> |                                |                   |                      |      |            |
| 26.01                            | Torque reference to TC         | <i>Real</i>       | -1600.0 ... 1600.0   | %    | 10 = 1%    |
| 26.02                            | Torque reference used          | <i>Real</i>       | -1600.0 ... 1600.0   | %    | 10 = 1%    |
| 26.08                            | Minimum torque ref             | <i>Real</i>       | -1000.0 ... 0.0      | %    | 10 = 1%    |
| 26.09                            | Maximum torque ref             | <i>Real</i>       | 0.0 ... 1000.0       | %    | 10 = 1%    |
| 26.11                            | Torque ref1 source             | <i>Analog src</i> | -                    | -    | 1 = 1      |
| 26.12                            | Torque ref2 source             | <i>Analog src</i> | -                    | -    | 1 = 1      |
| 26.13                            | Torque ref1 function           | <i>List</i>       | 0...5                | -    | 1 = 1      |
| 26.14                            | Torque ref1/2 selection        | <i>Binary src</i> | -                    | -    | 1 = 1      |
| 26.15                            | Load share                     | <i>Real</i>       | -8.000 ... 8.000     | -    | 1000 = 1   |

| No.                                 | Name                           | Type              | Range                  | Unit | FbEq32     |
|-------------------------------------|--------------------------------|-------------------|------------------------|------|------------|
| 26.16                               | Torque additive 1 source       | <i>Analog src</i> | -                      | -    | 1 = 1      |
| 26.17                               | Torque ref filter time         | <i>Real</i>       | 0.000 ... 30.000       | s    | 1000 = 1 s |
| 26.18                               | Torque ramp up time            | <i>Real</i>       | 0.000 ... 60.000       | s    | 1000 = 1 s |
| 26.19                               | Torque ramp down time          | <i>Real</i>       | 0.000 ... 60.000       | s    | 1000 = 1 s |
| 26.25                               | Torque additive 2 source       | <i>Analog src</i> | -                      | -    | 1 = 1      |
| 26.26                               | Force torque ref add 2 zero    | <i>Binary src</i> | -                      | -    | 1 = 1      |
| 26.41                               | Torque step                    | <i>Real</i>       | -300.0 ... 300.0       | %    | 10 = 1%    |
| 26.42                               | Torque step enable             | <i>List</i>       | 0...1                  | -    | 1 = 1      |
| 26.51                               | Oscillation damping            | <i>Binary src</i> | -                      | -    | 1 = 1      |
| 26.52                               | Oscillation damping out enable | <i>Binary src</i> | -                      | -    | 1 = 1      |
| 26.53                               | Oscillation compensation input | <i>List</i>       | 0...1                  | -    | 1 = 1      |
| 26.55                               | Oscillation damping frequency  | <i>Real</i>       | 0.1 ... 60.0           | Hz   | 10 = 1 Hz  |
| 26.56                               | Oscillation damping phase      | <i>Real</i>       | 0...360                | deg  | 1 = 1 deg  |
| 26.57                               | Oscillation damping gain       | <i>Real</i>       | 0.0 ... 100.0          | %    | 10 = 1%    |
| 26.58                               | Oscillation damping output     | <i>Real</i>       | -1600.000 ... 1600.000 | %    | 1000 = 1%  |
| 26.70                               | Torque reference act 1         | <i>Real</i>       | -1600.0 ... 1600.0     | %    | 10 = 1%    |
| 26.71                               | Torque reference act 2         | <i>Real</i>       | -1600.0 ... 1600.0     | %    | 10 = 1%    |
| 26.72                               | Torque reference act 3         | <i>Real</i>       | -1600.0 ... 1600.0     | %    | 10 = 1%    |
| 26.73                               | Torque reference act 4         | <i>Real</i>       | -1600.0 ... 1600.0     | %    | 10 = 1%    |
| 26.74                               | Torque ref ramp out            | <i>Real</i>       | -1600.0 ... 1600.0     | %    | 10 = 1%    |
| 26.75                               | Torque reference act 5         | <i>Real</i>       | -1600.0 ... 1600.0     | %    | 10 = 1%    |
| 26.76                               | Torque reference act 6         | <i>Real</i>       | -1600.0 ... 1600.0     | %    | 10 = 1%    |
| 26.77                               | Torque ref add A actual        | <i>Real</i>       | -1600.0 ... 1600.0     | %    | 10 = 1%    |
| 26.78                               | Torque ref add B actual        | <i>Real</i>       | -1600.0 ... 1600.0     | %    | 10 = 1%    |
| 26.81                               | Rush control gain              | <i>Real</i>       | 0.0 ... 10000.0        | -    | 10 = 1     |
| 26.82                               | Rush control integration time  | <i>Real</i>       | 0.0 ... 10.0           | s    | 10 = 1 s   |
| <b>28 Frequency reference chain</b> |                                |                   |                        |      |            |
| 28.01                               | Frequency ref ramp input       | <i>Real</i>       | -500.00 ... 500.00     | Hz   | 100 = 1 Hz |
| 28.02                               | Frequency ref ramp output      | <i>Real</i>       | -500.00 ... 500.00     | Hz   | 100 = 1 Hz |
| 28.11                               | Frequency ref1 source          | <i>Analog src</i> | -                      | -    | 1 = 1      |
| 28.12                               | Frequency ref2 source          | <i>Analog src</i> | -                      | -    | 1 = 1      |
| 28.13                               | Frequency ref1 function        | <i>List</i>       | 0...5                  | -    | 1 = 1      |
| 28.14                               | Frequency ref1/2 selection     | <i>Binary src</i> | -                      | -    | 1 = 1      |
| 28.21                               | Constant frequency function    | <i>PB</i>         | 00b...11b              | -    | 1 = 1      |
| 28.22                               | Constant frequency sel1        | <i>Binary src</i> | -                      | -    | 1 = 1      |

| No.              | Name                           | Type              | Range                  | Unit | FbEq32      |
|------------------|--------------------------------|-------------------|------------------------|------|-------------|
| 28.23            | Constant frequency sel2        | <i>Binary src</i> | -                      | -    | 1 = 1       |
| 28.24            | Constant frequency sel3        | <i>Binary src</i> | -                      | -    | 1 = 1       |
| 28.26            | Constant frequency 1           | <i>Real</i>       | -500.00 ... 500.00     | Hz   | 100 = 1 Hz  |
| 28.27            | Constant frequency 2           | <i>Real</i>       | -500.00 ... 500.00     | Hz   | 100 = 1 Hz  |
| 28.28            | Constant frequency 3           | <i>Real</i>       | -500.00 ... 500.00     | Hz   | 100 = 1 Hz  |
| 28.29            | Constant frequency 4           | <i>Real</i>       | -500.00 ... 500.00     | Hz   | 100 = 1 Hz  |
| 28.30            | Constant frequency 5           | <i>Real</i>       | -500.00 ... 500.00     | Hz   | 100 = 1 Hz  |
| 28.31            | Constant frequency 6           | <i>Real</i>       | -500.00 ... 500.00     | Hz   | 100 = 1 Hz  |
| 28.32            | Constant frequency 7           | <i>Real</i>       | -500.00 ... 500.00     | Hz   | 100 = 1 Hz  |
| 28.41            | Frequency ref safe             | <i>Real</i>       | -500.00 ... 500.00     | Hz   | 100 = 1 Hz  |
| 28.51            | Critical frequency function    | <i>PB</i>         | 00b...11b              | -    | 1 = 1       |
| 28.52            | Critical frequency 1 low       | <i>Real</i>       | -500.00 ... 500.00     | Hz   | 100 = 1 Hz  |
| 28.53            | Critical frequency 1 high      | <i>Real</i>       | -500.00 ... 500.00     | Hz   | 100 = 1 Hz  |
| 28.54            | Critical frequency 2 low       | <i>Real</i>       | -500.00 ... 500.00     | Hz   | 100 = 1 Hz  |
| 28.55            | Critical frequency 2 high      | <i>Real</i>       | -500.00 ... 500.00     | Hz   | 100 = 1 Hz  |
| 28.56            | Critical frequency 3 low       | <i>Real</i>       | -500.00 ... 500.00     | Hz   | 100 = 1 Hz  |
| 28.57            | Critical frequency 3 high      | <i>Real</i>       | -500.00 ... 500.00     | Hz   | 100 = 1 Hz  |
| 28.71            | Freq ramp set selection        | <i>Binary src</i> | -                      | -    | 1 = 1       |
| 28.72            | Freq acceleration time 1       | <i>Real</i>       | 0.000 ...1800.000      | s    | 1000 = 1 s  |
| 28.73            | Freq deceleration time 1       | <i>Real</i>       | 0.000 ...1800.000      | s    | 1000 = 1 s  |
| 28.74            | Freq acceleration time 2       | <i>Real</i>       | 0.000 ...1800.000      | s    | 1000 = 1 s  |
| 28.75            | Freq deceleration time 2       | <i>Real</i>       | 0.000 ...1800.000      | s    | 1000 = 1 s  |
| 28.76            | Freq ramp in zero source       | <i>Binary src</i> | -                      | -    | 1 = 1       |
| 28.77            | Freq ramp hold                 | <i>Binary src</i> | -                      | -    | 1 = 1       |
| 28.78            | Freq ramp output balancing     | <i>Real</i>       | -500.00 ... 500.00     | Hz   | 100 = 1 Hz  |
| 28.79            | Freq ramp out balancing enable | <i>Binary src</i> | -                      | -    | 1 = 1       |
| 28.90            | Frequency ref act 1            | <i>Real</i>       | -500.00 ... 500.00     | Hz   | 100 = 1 Hz  |
| 28.91            | Frequency ref act 2            | <i>Real</i>       | -500.00 ... 500.00     | Hz   | 100 = 1 Hz  |
| 28.92            | Frequency ref act 3            | <i>Real</i>       | -500.00 ... 500.00     | Hz   | 100 = 1 Hz  |
| 28.96            | Frequency ref act 7            | <i>Real</i>       | -500.00 ... 500.00     | Hz   | 100 = 1 Hz  |
| 28.97            | Frequency ref unlimited        | <i>Real</i>       | -500.00 ... 500.00     | Hz   | 100 = 1 Hz  |
| <b>30 Limits</b> |                                |                   |                        |      |             |
| 30.01            | Limit word 1                   | <i>PB</i>         | 0000h...FFFFh          | -    | 1 = 1       |
| 30.02            | Torque limit status            | <i>PB</i>         | 0000h...FFFFh          | -    | 1 = 1       |
| 30.11            | Minimum speed                  | <i>Real</i>       | -30000.00 ... 30000.00 | rpm  | 100 = 1 rpm |
| 30.12            | Maximum speed                  | <i>Real</i>       | -30000.00 ... 30000.00 | rpm  | 100 = 1 rpm |
| 30.13            | Minimum frequency              | <i>Real</i>       | -500.00 ... 500.00     | Hz   | 100 = 1 Hz  |



| No.   | Name                         | Type              | Range              | Unit | FbEq32     |
|---|------------------------------|-------------------|--------------------|------|------------|
| 30.14   | Maximum frequency            | <i>Real</i>       | -500.00 ... 500.00 | Hz   | 100 = 1 Hz |
| 30.15   | Maximum start current enable | <i>List</i>       | 0...1              | -    | 1 = 1      |
| 30.16   | Maximum start current        | <i>Real</i>       | 0.00 ... 30000.00  | A    | 100 = 1 A  |
| 30.17   | Maximum current              | <i>Real</i>       | 0.00 ... 30000.00  | A    | 100 = 1 A  |
| 30.18   | Minimum torque sel           | <i>Binary src</i> | -                  | -    | 1 = 1      |
| 30.19   | Minimum torque 1             | <i>Real</i>       | -1600.0 ... 0.0    | %    | 10 = 1%    |
| 30.20   | Maximum torque 1             | <i>Real</i>       | 0.0 ... 1600.0     | %    | 10 = 1%    |
| 30.21   | Minimum torque 2 source      | <i>Analog src</i> | -                  | -    | 1 = 1      |
| 30.22   | Maximum torque 2 source      | <i>Analog src</i> | -                  | -    | 1 = 1      |
| 30.23   | Minimum torque 2             | <i>Real</i>       | -1600.0 ... 0.0    | %    | 10 = 1%    |
| 30.24   | Maximum torque 2             | <i>Real</i>       | 0.0 ... 1600.0     | %    | 10 = 1%    |
| 30.25   | Maximum torque sel           | <i>Binary src</i> | -                  | -    | 1 = 1      |
| 30.26   | Power motoring limit         | <i>Real</i>       | 0.00 ... 600.00    | %    | 100 = 1%   |
| 30.27   | Power generating limit       | <i>Real</i>       | -600.00 ... 0.00   | %    | 100 = 1%   |
| 30.30   | Oversvoltage control         | <i>List</i>       | 0...1              | -    | 1 = 1      |
| 30.31   | Undervoltage control         | <i>List</i>       | 0...1              | -    | 1 = 1      |
| <i>(Parameters 30.101...30.149 only visible when IGBT supply unit control activated by 95.20)</i> |                              |                   |                    |      |            |
| 30.101  | LSU limit word 1             | <i>PB</i>         | 0000h...FFFFh      | -    | 1 = 1      |
| 30.102  | LSU limit word 2             | <i>PB</i>         | 0000h...FFFFh      | -    | 1 = 1      |
| 30.103  | LSU limit word 3             | <i>PB</i>         | 0000h...FFFFh      | -    | 1 = 1      |
| 30.104  | LSU limit word 4             | <i>PB</i>         | 0000h...FFFFh      | -    | 1 = 1      |
| 30.148  | LSU minimum power limit      | <i>Real</i>       | -200.0 ... 0.0     | %    | 10 = 1%    |
| 30.149  | LSU maximum power limit      | <i>Real</i>       | 0.0 ... 200.0      | %    | 10 = 1%    |
| <b>31 Fault functions</b>   |                              |                   |                    |      |            |
| 31.01   | External event 1 source      | <i>Binary src</i> | -                  | -    | 1 = 1      |
| 31.02   | External event 1 type        | <i>List</i>       | 0...3              | -    | 1 = 1      |
| 31.03   | External event 2 source      | <i>Binary src</i> | -                  | -    | 1 = 1      |
| 31.04   | External event 2 type        | <i>List</i>       | 0...3              | -    | 1 = 1      |
| 31.05   | External event 3 source      | <i>Binary src</i> | -                  | -    | 1 = 1      |
| 31.06   | External event 3 type        | <i>List</i>       | 0...3              | -    | 1 = 1      |
| 31.07   | External event 4 source      | <i>Binary src</i> | -                  | -    | 1 = 1      |
| 31.08   | External event 4 type        | <i>List</i>       | 0...3              | -    | 1 = 1      |
| 31.09   | External event 5 source      | <i>Binary src</i> | -                  | -    | 1 = 1      |
| 31.10   | External event 5 type        | <i>List</i>       | 0...3              | -    | 1 = 1      |

## 458 Additional parameter data

| No.   | Name                             | Type              | Range                           | Unit | FbEq32      |
|---|----------------------------------|-------------------|---------------------------------|------|-------------|
| 31.11   | Fault reset selection            | <i>Binary src</i> | -                               | -    | 1 = 1       |
| 31.12   | Autoreset selection              | <i>PB</i>         | 0000h...FFFFh                   | -    | 1 = 1       |
| 31.13   | User selectable fault            | <i>Real</i>       | 0000h...FFFFh                   | -    | 1 = 1       |
| 31.14   | Number of trials                 | <i>Real</i>       | 0...5                           | -    | 1 = 1       |
| 31.15   | Total trials time                | <i>Real</i>       | 1.0 ... 600.0                   | s    | 10 = 1 s    |
| 31.16   | Delay time                       | <i>Real</i>       | 0.0 ... 120.0                   | s    | 10 = 1 s    |
| 31.19   | Motor phase loss                 | <i>List</i>       | 0...1                           | -    | 1 = 1       |
| 31.20   | Earth fault                      | <i>List</i>       | 0...2                           | -    | 1 = 1       |
| 31.21   | Supply phase loss                | <i>List</i>       | 0...1                           | -    | 1 = 1       |
| 31.22   | STO indication run/stop          | <i>List</i>       | 0...5                           | -    | 1 = 1       |
| 31.23   | Wiring or earth fault            | <i>List</i>       | 0...1                           | -    | 1 = 1       |
| 31.24   | Stall function                   | <i>List</i>       | 0...2                           | -    | 1 = 1       |
| 31.25   | Stall current limit              | <i>Real</i>       | 0.0 ... 1600.0                  | %    | 10 = 1%     |
| 31.26   | Stall speed limit                | <i>Real</i>       | 0.00 ... 10000.00               | rpm  | 100 = 1 rpm |
| 31.27   | Stall frequency limit            | <i>Real</i>       | 0.00 ... 500.00                 | Hz   | 100 = 1 Hz  |
| 31.28   | Stall time                       | <i>Real</i>       | 0...3600                        | s    | 1 = 1 s     |
| 31.30   | Overspeed trip margin            | <i>Real</i>       | 0.00 ... 10000.00               | rpm  | 100 = 1 rpm |
| 31.32   | Emergency ramp supervision       | <i>Real</i>       | 0...300                         | %    | 1 = 1%      |
| 31.33   | Emergency ramp supervision delay | <i>Real</i>       | 0...32767                       | s    | 1 = 1 s     |
| 31.35   | Main fan fault function          | <i>List</i>       | 0...2                           | -    | 1 = 1       |
| 31.36   | Aux fan fault bypass             | <i>List</i>       | 0...1                           | -    | 1 = 1       |
| 31.37   | Ramp stop supervision            | <i>Real</i>       | 0...300                         | %    | 1 = 1%      |
| 31.38   | Ramp stop supervision delay      | <i>Real</i>       | 0...32767                       | s    | 1 = 1 s     |
| 31.40   | Disable warning messages         | <i>PB</i>         | 0000h...FFFFh                   | -    | 1 = 1       |
| 31.42   | Overcurrent fault limit          | <i>Real</i>       | 0.00 ... 30000.00               | A    | 100 = 1 A   |
| <i>(Parameters 31.120...31.121 only visible when IGBT supply unit control activated by 95.20)</i> |                                  |                   |                                 |      |             |
| 31.120  | LSU earth fault                  | <i>List</i>       | 0...1                           | -    | 1 = 1       |
| 31.121  | LSU supply phase loss            | <i>List</i>       | 0...1                           | -    | 1 = 1       |
| <b>32 Supervision</b>   |                                  |                   |                                 |      |             |
| 32.01   | Supervision status               | <i>PB</i>         | 000b...111b                     | -    | 1 = 1       |
| 32.05   | Supervision 1 function           | <i>List</i>       | 0...6                           | -    | 1 = 1       |
| 32.06   | Supervision 1 action             | <i>List</i>       | 0...3                           | -    | 1 = 1       |
| 32.07   | Supervision 1 signal             | <i>Analog src</i> | -                               | -    | 1 = 1       |
| 32.08   | Supervision 1 filter time        | <i>Real</i>       | 0.000 ... 30.000                | s    | 1000 = 1 s  |
| 32.09   | Supervision 1 low                | <i>Real</i>       | -21474830.00 ...<br>21474830.00 | -    | 100 = 1     |
| 32.10   | Supervision 1 high               | <i>Real</i>       | -21474830.00 ...<br>21474830.00 | -    | 100 = 1     |
| 32.15   | Supervision 2 function           | <i>List</i>       | 0...6                           | -    | 1 = 1       |
| 32.16   | Supervision 2 action             | <i>List</i>       | 0...3                           | -    | 1 = 1       |

| No.                                   | Name                        | Type              | Range                           | Unit | FbEq32     |
|---------------------------------------|-----------------------------|-------------------|---------------------------------|------|------------|
| 32.17                                 | Supervision 2 signal        | <i>Analog src</i> | -                               | -    | 1 = 1      |
| 32.18                                 | Supervision 2 filter time   | <i>Real</i>       | 0.000 ... 30.000                | s    | 1000 = 1 s |
| 32.19                                 | Supervision 2 low           | <i>Real</i>       | -21474830.00 ...<br>21474830.00 | -    | 100 = 1    |
| 32.20                                 | Supervision 2 high          | <i>Real</i>       | -21474830.00 ...<br>21474830.00 | -    | 100 = 1    |
| 32.25                                 | Supervision 3 function      | <i>List</i>       | 0...6                           | -    | 1 = 1      |
| 32.26                                 | Supervision 3 action        | <i>List</i>       | 0...3                           | -    | 1 = 1      |
| 32.27                                 | Supervision 3 signal        | <i>Analog src</i> | -                               | -    | 1 = 1      |
| 32.28                                 | Supervision 3 filter time   | <i>Real</i>       | 0.000 ... 30.000                | s    | 1000 = 1 s |
| 32.29                                 | Supervision 3 low           | <i>Real</i>       | -21474830.00 ...<br>21474830.00 | -    | 100 = 1    |
| 32.30                                 | Supervision 3 high          | <i>Real</i>       | -21474830.00 ...<br>21474830.00 | -    | 100 = 1    |
| <b>33 Generic timer &amp; counter</b> |                             |                   |                                 |      |            |
| 33.01                                 | Counter status              | <i>PB</i>         | 000000b...111111b               | -    | 1 = 1      |
| 33.10                                 | On-time 1 actual            | <i>Real</i>       | 0...4294967295                  | s    | 1 = 1 s    |
| 33.11                                 | On-time 1 warn limit        | <i>Real</i>       | 0...4294967295                  | s    | 1 = 1 s    |
| 33.12                                 | On-time 1 function          | <i>PB</i>         | 00b...11b                       | -    | 1 = 1      |
| 33.13                                 | On-time 1 source            | <i>Binary src</i> | -                               | -    | 1 = 1      |
| 33.14                                 | On-time 1 warn message      | <i>List</i>       | -                               | -    | 1 = 1      |
| 33.20                                 | On-time 2 actual            | <i>Real</i>       | 0...4294967295                  | s    | 1 = 1 s    |
| 33.21                                 | On-time 2 warn limit        | <i>Real</i>       | 0...4294967295                  | s    | 1 = 1 s    |
| 33.22                                 | On-time 2 function          | <i>PB</i>         | 00b...11b                       | -    | 1 = 1      |
| 33.23                                 | On-time 2 source            | <i>Binary src</i> | -                               | -    | 1 = 1      |
| 33.24                                 | On-time 2 warn message      | <i>List</i>       | -                               | -    | 1 = 1      |
| 33.30                                 | Edge counter 1 actual       | <i>Real</i>       | 0...4294967295                  | -    | 1 = 1      |
| 33.31                                 | Edge counter 1 warn limit   | <i>Real</i>       | 0...4294967295                  | -    | 1 = 1      |
| 33.32                                 | Edge counter 1 function     | <i>PB</i>         | 0000b...1111b                   | -    | 1 = 1      |
| 33.33                                 | Edge counter 1 source       | <i>Binary src</i> | -                               | -    | 1 = 1      |
| 33.34                                 | Edge counter 1 divider      | <i>Real</i>       | 1...4294967295                  | -    | 1 = 1      |
| 33.35                                 | Edge counter 1 warn message | <i>List</i>       | -                               | -    | 1 = 1      |
| 33.40                                 | Edge counter 2 actual       | <i>Real</i>       | 0...4294967295                  | -    | 1 = 1      |
| 33.41                                 | Edge counter 2 warn limit   | <i>Real</i>       | 0...4294967295                  | -    | 1 = 1      |
| 33.42                                 | Edge counter 2 function     | <i>PB</i>         | 0000b...1111b                   | -    | 1 = 1      |
| 33.43                                 | Edge counter 2 source       | <i>Binary src</i> | -                               | -    | 1 = 1      |
| 33.44                                 | Edge counter 2 divider      | <i>Real</i>       | 1...4294967295                  | -    | 1 = 1      |
| 33.45                                 | Edge counter 2 warn message | <i>List</i>       | -                               | -    | 1 = 1      |

460 Additional parameter data

| No.                                | Name                         | Type                  | Range  | Unit             | FbEq32     |
|------------------------------------|------------------------------|-----------------------|--|------------------|------------|
| 33.50                              | Value counter 1 actual       | <i>Real</i>           | -2147483008 ...<br>2147483008                          | -                | 1 = 1      |
| 33.51                              | Value counter 1 warn limit   | <i>Real</i>           | -2147483008 ...<br>2147483008                          | -                | 1 = 1      |
| 33.52                              | Value counter 1 function     | <i>PB</i>             | 00b...11b  | -                | 1 = 1      |
| 33.53                              | Value counter 1 source       | <i>Analog<br/>src</i> | -  | -                | 1 = 1      |
| 33.54                              | Value counter 1 divider      | <i>Real</i>           | 0.001 ... 2147483.000                                  | -                | 1000 = 1   |
| 33.55                              | Value counter 1 warn message | <i>List</i>           | -  | -                | 1 = 1      |
| 33.60                              | Value counter 2 actual       | <i>Real</i>           | -2147483008 ...<br>2147483008                          | -                | 1 = 1      |
| 33.61                              | Value counter 2 warn limit   | <i>Real</i>           | -2147483008 ...<br>2147483008                          | -                | 1 = 1      |
| 33.62                              | Value counter 2 function     | <i>PB</i>             | 00b...11b  | -                | 1 = 1      |
| 33.63                              | Value counter 2 source       | <i>Analog<br/>src</i> | -  | -                | 1 = 1      |
| 33.64                              | Value counter 2 divider      | <i>Real</i>           | 0.001 ... 2147483.000                                  | -                | 1000 = 1   |
| 33.65                              | Value counter 2 warn message | <i>List</i>           | -  | -                | 1 = 1      |
| <b>35 Motor thermal protection</b> |                              |                       |  |                  |            |
| 35.01                              | Motor estimated temperature  | <i>Real</i>           | -60 ... 1000   | °C or °F         | 1 = 1°     |
| 35.02                              | Measured temperature 1       | <i>Real</i>           | -60 ... 1000 °C,<br>-76 ... 1832 °F,<br>0...5000 ohm   | °C, °F or<br>ohm | 1 = 1 unit |
| 35.03                              | Measured temperature 2       | <i>Real</i>           | -60 ... 1000 °C,<br>-76 ... 1832 °F,<br>0...5000 ohm   | °C, °F or<br>ohm | 1 = 1 unit |
| 35.04                              | FPTC status word             | <i>PB</i>             | 0000h...FFFFh  | -                | 1 = 1      |
| 35.11                              | Temperature 1 source         | <i>List</i>           | 0...11   | -                | 1 = 1      |
| 35.12                              | Temperature 1 fault limit    | <i>Real</i>           | -60 ... 1000 °C,<br>-76 ... 1832 °F or<br>0...5000 ohm | °C, °F or<br>ohm | 1 = 1 unit |
| 35.13                              | Temperature 1 warning limit  | <i>Real</i>           | -60 ... 1000 °C,<br>-76 ... 1832 °F or<br>0...5000 ohm | °C, °F or<br>ohm | 1 = 1 unit |
| 35.14                              | Temperature 1 AI source      | <i>Analog<br/>src</i> | -  | -                | 1 = 1      |
| 35.21                              | Temperature 2 source         | <i>List</i>           | 0...11   | -                | 1 = 1      |
| 35.22                              | Temperature 2 fault limit    | <i>Real</i>           | -60 ... 1000 °C,<br>-76 ... 1832 °F or<br>0...5000 ohm | °C, °F or<br>ohm | 1 = 1 unit |
| 35.23                              | Temperature 2 warning limit  | <i>Real</i>           | -60 ... 1000 °C,<br>-76 ... 1832 °F or<br>0...5000 ohm | °C, °F or<br>ohm | 1 = 1 unit |
| 35.24                              | Temperature 2 AI source      | <i>Analog<br/>src</i> | -  | -                | 1 = 1      |
| 35.30                              | FPTC configuration word      | <i>PB</i>             | 0000h...FFFFh  | -                | 1 = 1      |
| 35.50                              | Motor ambient temperature    | <i>Real</i>           | -60 ... 100 °C or<br>-76 ... 212 °F                    | °C or °F         | 1 = 1°     |

| No.                     | Name                           | Type              | Range                     | Unit     | FbEq32      |
|-------------------------|--------------------------------|-------------------|---------------------------|----------|-------------|
| 35.51                   | Motor load curve               | <i>Real</i>       | 50...150                  | %        | 1 = 1%      |
| 35.52                   | Zero speed load                | <i>Real</i>       | 50...150                  | %        | 1 = 1%      |
| 35.53                   | Break point                    | <i>Real</i>       | 1.00 ... 500.00           | Hz       | 100 = 1 Hz  |
| 35.54                   | Motor nominal temperature rise | <i>Real</i>       | 0...300 °C or 32...572 °F | °C or °F | 1 = 1°      |
| 35.55                   | Motor thermal time constant    | <i>Real</i>       | 100...10000               | s        | 1 = 1 s     |
| 35.60                   | Cable temperature              | <i>Real</i>       | 0.0 ... 200.0             | %        | 10 = 1%     |
| 35.61                   | Cable nominal current          | <i>Real</i>       | 0.00 ... 10000.0          | A        | 100 = 1 A   |
| 35.62                   | Cable thermal rise time        | <i>Real</i>       | 0...50000                 | s        | 1 = 1 s     |
| 35.100                  | DOL starter control source     | <i>Binary src</i> | -                         | -        | 1 = 1       |
| 35.101                  | DOL starter on delay           | <i>Real</i>       | 0...42949673              | s        | 1 = 1 s     |
| 35.102                  | DOL starter off delay          | <i>Real</i>       | 0...715828                | min      | 1 = 1 min   |
| 35.103                  | DOL starter feedback source    | <i>Binary src</i> | -                         | -        | 1 = 1       |
| 35.104                  | DOL starter feedback delay     | <i>Real</i>       | 0...42949673              | s        | 1 = 1 s     |
| 35.105                  | DOL starter status word        | <i>PB</i>         | 0000b...1111b             | -        | 1 = 1       |
| 35.106                  | DOL starter event type         | <i>List</i>       | 0...2                     | -        | 1 = 1       |
| <b>36 Load analyzer</b> |                                |                   |                           |          |             |
| 36.01                   | PVL signal source              | <i>Analog src</i> | -                         | -        | 1 = 1       |
| 36.02                   | PVL filter time                | <i>Real</i>       | 0.00 ... 120.00           | s        | 100 = 1 s   |
| 36.06                   | AL2 signal source              | <i>Analog src</i> | -                         | -        | 1 = 1       |
| 36.07                   | AL2 signal scaling             | <i>Real</i>       | 0.00 ... 32767.00         | -        | 100 = 1     |
| 36.09                   | Reset loggers                  | <i>List</i>       | 0...3                     | -        | 1 = 1       |
| 36.10                   | PVL peak value                 | <i>Real</i>       | -32768.00 ... 32767.00    | -        | 100 = 1     |
| 36.11                   | PVL peak date                  | <i>Data</i>       | -                         | -        | 1 = 1       |
| 36.12                   | PVL peak time                  | <i>Data</i>       | -                         | -        | 1 = 1       |
| 36.13                   | PVL current at peak            | <i>Real</i>       | -32768.00 ... 32767.00    | A        | 100 = 1 A   |
| 36.14                   | PVL DC voltage at peak         | <i>Real</i>       | 0.00 ... 2000.00          | V        | 100 = 1 V   |
| 36.15                   | PVL speed at peak              | <i>Real</i>       | -32768.00 ... 32767.00    | rpm      | 100 = 1 rpm |
| 36.16                   | PVL reset date                 | <i>Data</i>       | -                         | -        | 1 = 1       |
| 36.17                   | PVL reset time                 | <i>Data</i>       | -                         | -        | 1 = 1       |
| 36.20                   | AL1 below 10%                  | <i>Real</i>       | 0.00 ... 100.00           | %        | 100 = 1%    |
| 36.21                   | AL1 10 to 20%                  | <i>Real</i>       | 0.00 ... 100.00           | %        | 100 = 1%    |
| 36.22                   | AL1 20 to 30%                  | <i>Real</i>       | 0.00 ... 100.00           | %        | 100 = 1%    |
| 36.23                   | AL1 30 to 40%                  | <i>Real</i>       | 0.00 ... 100.00           | %        | 100 = 1%    |
| 36.24                   | AL1 40 to 50%                  | <i>Real</i>       | 0.00 ... 100.00           | %        | 100 = 1%    |
| 36.25                   | AL1 50 to 60%                  | <i>Real</i>       | 0.00 ... 100.00           | %        | 100 = 1%    |
| 36.26                   | AL1 60 to 70%                  | <i>Real</i>       | 0.00 ... 100.00           | %        | 100 = 1%    |
| 36.27                   | AL1 70 to 80%                  | <i>Real</i>       | 0.00 ... 100.00           | %        | 100 = 1%    |
| 36.28                   | AL1 80 to 90%                  | <i>Real</i>       | 0.00 ... 100.00           | %        | 100 = 1%    |

## 462 Additional parameter data

| No.                       | Name                        | Type        | Range           | Unit | FbEq32     |
|---------------------------|-----------------------------|-------------|-----------------|------|------------|
| 36.29                     | AL1 over 90%                | <i>Real</i> | 0.00 ... 100.00 | %    | 100 = 1%   |
| 36.40                     | AL2 below 10%               | <i>Real</i> | 0.00 ... 100.00 | %    | 100 = 1%   |
| 36.41                     | AL2 10 to 20%               | <i>Real</i> | 0.00 ... 100.00 | %    | 100 = 1%   |
| 36.42                     | AL2 20 to 30%               | <i>Real</i> | 0.00 ... 100.00 | %    | 100 = 1%   |
| 36.43                     | AL2 30 to 40%               | <i>Real</i> | 0.00 ... 100.00 | %    | 100 = 1%   |
| 36.44                     | AL2 40 to 50%               | <i>Real</i> | 0.00 ... 100.00 | %    | 100 = 1%   |
| 36.45                     | AL2 50 to 60%               | <i>Real</i> | 0.00 ... 100.00 | %    | 100 = 1%   |
| 36.46                     | AL2 60 to 70%               | <i>Real</i> | 0.00 ... 100.00 | %    | 100 = 1%   |
| 36.47                     | AL2 70 to 80%               | <i>Real</i> | 0.00 ... 100.00 | %    | 100 = 1%   |
| 36.48                     | AL2 80 to 90%               | <i>Real</i> | 0.00 ... 100.00 | %    | 100 = 1%   |
| 36.49                     | AL2 over 90%                | <i>Real</i> | 0.00 ... 100.00 | %    | 100 = 1%   |
| 36.50                     | AL2 reset date              | <i>Data</i> | -               | -    | 1 = 1      |
| 36.51                     | AL2 reset time              | <i>Data</i> | -               | -    | 1 = 1      |
| <b>37 User load curve</b> |                             |             |                 |      |            |
| 37.01                     | ULC output status word      | <i>PB</i>   | 0000h...FFFFh   | -    | 1 = 1      |
| 37.02                     | ULC supervision signal      | <i>List</i> | -               | -    | 1 = 1      |
| 37.03                     | ULC overload actions        | <i>List</i> | 0...3           | -    | 1 = 1      |
| 37.04                     | ULC underload actions       | <i>List</i> | 0...3           | -    | 1 = 1      |
| 37.11                     | ULC speed table point 1     | <i>Real</i> | 0.0 ... 30000.0 | rpm  | 10 = 1 rpm |
| 37.12                     | ULC speed table point 2     | <i>Real</i> | 0.0 ... 30000.0 | rpm  | 10 = 1 rpm |
| 37.13                     | ULC speed table point 3     | <i>Real</i> | 0.0 ... 30000.0 | rpm  | 10 = 1 rpm |
| 37.14                     | ULC speed table point 4     | <i>Real</i> | 0.0 ... 30000.0 | rpm  | 10 = 1 rpm |
| 37.15                     | ULC speed table point 5     | <i>Real</i> | 0.0 ... 30000.0 | rpm  | 10 = 1 rpm |
| 37.16                     | ULC frequency table point 1 | <i>Real</i> | 0.0 ... 500.0   | Hz   | 10 = 1 Hz  |
| 37.17                     | ULC frequency table point 2 | <i>Real</i> | 0.0 ... 500.0   | Hz   | 10 = 1 Hz  |
| 37.18                     | ULC frequency table point 3 | <i>Real</i> | 0.0 ... 500.0   | Hz   | 10 = 1 Hz  |
| 37.19                     | ULC frequency table point 4 | <i>Real</i> | 0.0 ... 500.0   | Hz   | 10 = 1 Hz  |
| 37.20                     | ULC frequency table point 5 | <i>Real</i> | 0.0 ... 500.0   | Hz   | 10 = 1 Hz  |
| 37.21                     | ULC underload point 1       | <i>Real</i> | 0.0 ... 1600.0  | %    | 10 = 1%    |
| 37.22                     | ULC underload point 2       | <i>Real</i> | 0.0 ... 1600.0  | %    | 10 = 1%    |
| 37.23                     | ULC underload point 3       | <i>Real</i> | 0.0 ... 1600.0  | %    | 10 = 1%    |
| 37.24                     | ULC underload point 4       | <i>Real</i> | 0.0 ... 1600.0  | %    | 10 = 1%    |
| 37.25                     | ULC underload point 5       | <i>Real</i> | 0.0 ... 1600.0  | %    | 10 = 1%    |
| 37.31                     | ULC overload point 1        | <i>Real</i> | 0.0 ... 1600.0  | %    | 10 = 1%    |
| 37.32                     | ULC overload point 2        | <i>Real</i> | 0.0 ... 1600.0  | %    | 10 = 1%    |
| 37.33                     | ULC overload point 3        | <i>Real</i> | 0.0 ... 1600.0  | %    | 10 = 1%    |
| 37.34                     | ULC overload point 4        | <i>Real</i> | 0.0 ... 1600.0  | %    | 10 = 1%    |
| 37.35                     | ULC overload point 5        | <i>Real</i> | 0.0 ... 1600.0  | %    | 10 = 1%    |
| 37.41                     | ULC overload timer          | <i>Real</i> | 0.0 ... 10000.0 | s    | 10 = 1 s   |
| 37.42                     | ULC underload timer         | <i>Real</i> | 0.0 ... 10000.0 | s    | 10 = 1 s   |

| No.                         | Name                         | Type              | Range                  | Unit         | FbEq32               |
|-----------------------------|------------------------------|-------------------|------------------------|--------------|----------------------|
| <b>40 Process PID set 1</b> |                              |                   |                        |              |                      |
| 40.01                       | Process PID output actual    | <i>Real</i>       | -32768.00 ... 32767.00 | rpm, % or Hz | 100 = 1 rpm, % or Hz |
| 40.02                       | Process PID feedback actual  | <i>Real</i>       | -32768.00 ... 32767.00 | rpm, % or Hz | 100 = 1 rpm, % or Hz |
| 40.03                       | Process PID setpoint actual  | <i>Real</i>       | -32768.00 ... 32767.00 | rpm, % or Hz | 100 = 1 rpm, % or Hz |
| 40.04                       | Process PID deviation actual | <i>Real</i>       | -32768.00 ... 32767.00 | rpm, % or Hz | 100 = 1 rpm, % or Hz |
| 40.05                       | Process PID trim output act  | <i>Real</i>       | -32768.00 ... 32767.00 | rpm, % or Hz | 100 = 1 rpm, % or Hz |
| 40.06                       | Process PID status word      | <i>PB</i>         | 0000h...FFFFh          | -            | 1 = 1                |
| 40.07                       | Set 1 PID operation mode     | <i>List</i>       | 0...2                  | -            | 1 = 1                |
| 40.08                       | Set 1 feedback 1 source      | <i>Analog src</i> | -                      | -            | 1 = 1                |
| 40.09                       | Set 1 feedback 2 source      | <i>Analog src</i> | -                      | -            | 1 = 1                |
| 40.10                       | Set 1 feedback function      | <i>List</i>       | 0...11                 | -            | 1 = 1                |
| 40.11                       | Set 1 feedback filter time   | <i>Real</i>       | 0.000 ... 30.000       | s            | 1000 = 1 s           |
| 40.12                       | Set 1 unit selection         | <i>List</i>       | 0...2                  | -            | 1 = 1                |
| 40.14                       | Set 1 setpoint scaling       | <i>Real</i>       | -32768.00 ... 32767.00 | -            | 100 = 1              |
| 40.15                       | Set 1 output scaling         | <i>Real</i>       | -32768.00 ... 32767.00 | -            | 100 = 1              |
| 40.16                       | Set 1 setpoint 1 source      | <i>Analog src</i> | -                      | -            | 1 = 1                |
| 40.17                       | Set 1 setpoint 2 source      | <i>Analog src</i> | -                      | -            | 1 = 1                |
| 40.18                       | Set 1 setpoint function      | <i>List</i>       | 0...11                 | -            | 1 = 1                |
| 40.19                       | Set 1 internal setpoint sel1 | <i>Binary src</i> | -                      | -            | 1 = 1                |
| 40.20                       | Set 1 internal setpoint sel2 | <i>Binary src</i> | -                      | -            | 1 = 1                |
| 40.21                       | Set 1 internal setpoint 1    | <i>Real</i>       | -32768.00 ... 32767.00 | rpm, % or Hz | 100 = 1 rpm, % or Hz |
| 40.22                       | Set 1 internal setpoint 2    | <i>Real</i>       | -32768.00 ... 32767.00 | rpm, % or Hz | 100 = 1 rpm, % or Hz |
| 40.23                       | Set 1 internal setpoint 3    | <i>Real</i>       | -32768.00 ... 32767.00 | rpm, % or Hz | 100 = 1 rpm, % or Hz |
| 40.24                       | Set 1 internal setpoint 4    | <i>Real</i>       | -32768.00 ... 32767.00 | rpm, % or Hz | 100 = 1 rpm, % or Hz |
| 40.25                       | Set 1 setpoint selection     | <i>Binary src</i> | -                      | -            | 1 = 1                |
| 40.26                       | Set 1 setpoint min           | <i>Real</i>       | -32768.00 ... 32767.00 | -            | 100 = 1              |
| 40.27                       | Set 1 setpoint max           | <i>Real</i>       | -32768.00 ... 32767.00 | -            | 100 = 1              |
| 40.28                       | Set 1 setpoint increase time | <i>Real</i>       | 0.0 ... 1800.0         | s            | 10 = 1 s             |
| 40.29                       | Set 1 setpoint decrease time | <i>Real</i>       | 0.0 ... 1800.0         | s            | 10 = 1 s             |
| 40.30                       | Set 1 setpoint freeze enable | <i>Binary src</i> | -                      | -            | 1 = 1                |

## 464 Additional parameter data

| No.                         | Name                         | Type              | Range                  | Unit         | FbEq32               |
|-----------------------------|------------------------------|-------------------|------------------------|--------------|----------------------|
| 40.31                       | Set 1 deviation inversion    | <i>Binary src</i> | -                      | -            | 1 = 1                |
| 40.32                       | Set 1 gain                   | <i>Real</i>       | 0.10 ... 100.00        | -            | 100 = 1              |
| 40.33                       | Set 1 integration time       | <i>Real</i>       | 0.0 ... 32767.0        | s            | 10 = 1 s             |
| 40.34                       | Set 1 derivation time        | <i>Real</i>       | 0.000 ... 10.000       | s            | 1000 = 1 s           |
| 40.35                       | Set 1 derivation filter time | <i>Real</i>       | 0.0 ... 10.0           | s            | 10 = 1 s             |
| 40.36                       | Set 1 output min             | <i>Real</i>       | -32768.0 ... 32767.0   | -            | 10 = 1               |
| 40.37                       | Set 1 output max             | <i>Real</i>       | -32768.0 ... 32767.0   | -            | 10 = 1               |
| 40.38                       | Set 1 output freeze enable   | <i>Binary src</i> | -                      | -            | 1 = 1                |
| 40.39                       | Set 1 deadband range         | <i>Real</i>       | 0.0 ... 32767.0        | -            | 10 = 1               |
| 40.40                       | Set 1 deadband delay         | <i>Real</i>       | 0.0 ... 3600.0         | s            | 10 = 1 s             |
| 40.41                       | Set 1 sleep mode             | <i>List</i>       | 0...2                  | -            | 1 = 1                |
| 40.42                       | Set 1 sleep enable           | <i>Binary src</i> | -                      | -            | 1 = 1                |
| 40.43                       | Set 1 sleep level            | <i>Real</i>       | 0.0 ... 32767.0        | -            | 10 = 1               |
| 40.44                       | Set 1 sleep delay            | <i>Real</i>       | 0.0 ... 3600.0         | s            | 10 = 1 s             |
| 40.45                       | Set 1 sleep boost time       | <i>Real</i>       | 0.0 ... 3600.0         | s            | 10 = 1 s             |
| 40.46                       | Set 1 sleep boost step       | <i>Real</i>       | 0.0 ... 32767.0        | -            | 10 = 1               |
| 40.47                       | Set 1 wake-up deviation      | <i>Real</i>       | -32768.00 ... 32767.00 | rpm, % or Hz | 100 = 1 rpm, % or Hz |
| 40.48                       | Set 1 wake-up delay          | <i>Real</i>       | 0.00 ... 60.00         | s            | 100 = 1 s            |
| 40.49                       | Set 1 tracking mode          | <i>Binary src</i> | -                      | -            | 1 = 1                |
| 40.50                       | Set 1 tracking ref selection | <i>Analog src</i> | -                      | -            | 1 = 1                |
| 40.51                       | Set 1 trim mode              | <i>List</i>       | 0...3                  | -            | 1 = 1                |
| 40.52                       | Set 1 trim selection         | <i>List</i>       | 1...3                  | -            | 1 = 1                |
| 40.53                       | Set 1 trimmed ref pointer    | <i>Analog src</i> | -                      | -            | 1 = 1                |
| 40.54                       | Set 1 trim mix               | <i>Real</i>       | 0.000 ... 1.000        | -            | 1000 = 1             |
| 40.55                       | Set 1 trim adjust            | <i>Real</i>       | -100.000 ... 100.000   | -            | 1000 = 1             |
| 40.56                       | Set 1 trim source            | <i>List</i>       | 1...2                  | -            | 1 = 1                |
| 40.57                       | PID set1/set2 selection      | <i>Binary src</i> | -                      | -            | 1 = 1                |
| 40.60                       | Set 1 PID activation source  | <i>Binary src</i> | -                      | -            | 1 = 1                |
| 40.91                       | Feedback data storage        | <i>Real</i>       | -327.68 ... 327.67     | -            | 100 = 1              |
| 40.92                       | Setpoint data storage        | <i>Real</i>       | -327.68 ... 327.67     | -            | 100 = 1              |
| <b>41 Process PID set 2</b> |                              |                   |                        |              |                      |
| 41.07                       | Set 2 PID operation mode     | <i>List</i>       | 0...2                  | -            | 1 = 1                |
| 41.08                       | Set 2 feedback 1 source      | <i>Analog src</i> | -                      | -            | 1 = 1                |
| 41.09                       | Set 2 feedback 2 source      | <i>Analog src</i> | -                      | -            | 1 = 1                |



| No.   | Name                         | Type          | Range                | Unit            | FbEq32                  |
|-------|------------------------------|---------------|----------------------|-----------------|-------------------------|
| 41.10 | Set 2 feedback function      | List          | 0...11               | -               | 1 = 1                   |
| 41.11 | Set 2 feedback filter time   | Real          | 0.000 ... 30.000     | s               | 1000 = 1 s              |
| 41.12 | Set 2 unit selection         | List          | 0...2                | -               | 1 = 1                   |
| 41.14 | Set 2 setpoint scaling       | Real          | -32768 ... 32767     | -               | 100 = 1                 |
| 41.15 | Set 2 output scaling         | Real          | -32768 ... 32767     | -               | 100 = 1                 |
| 41.16 | Set 2 setpoint 1 source      | Analog<br>src | -                    | -               | 1 = 1                   |
| 41.17 | Set 2 setpoint 2 source      | Analog<br>src | -                    | -               | 1 = 1                   |
| 41.18 | Set 2 setpoint function      | List          | 0...11               | -               | 1 = 1                   |
| 41.19 | Set 2 internal setpoint sel1 | Binary<br>src | -                    | -               | 1 = 1                   |
| 41.20 | Set 2 internal setpoint sel2 | Binary<br>src | -                    | -               | 1 = 1                   |
| 41.21 | Set 2 internal setpoint 1    | Real          | -32768.0 ... 32767.0 | rpm, % or<br>Hz | 100 = 1 rpm, %<br>or Hz |
| 41.22 | Set 2 internal setpoint 2    | Real          | -32768.0 ... 32767.0 | rpm, % or<br>Hz | 100 = 1 rpm, %<br>or Hz |
| 41.23 | Set 2 internal setpoint 3    | Real          | -32768.0 ... 32767.0 | rpm, % or<br>Hz | 100 = 1 rpm, %<br>or Hz |
| 41.24 | Set 2 internal setpoint 4    | Real          | -32768.0 ... 32767.0 | rpm, % or<br>Hz | 100 = 1 rpm, %<br>or Hz |
| 41.25 | Set 2 setpoint selection     | Binary<br>src | -                    | -               | 1 = 1                   |
| 41.26 | Set 2 setpoint min           | Real          | -32768.0 ... 32767.0 | -               | 100 = 1                 |
| 41.27 | Set 2 setpoint max           | Real          | -32768.0 ... 32767.0 | -               | 100 = 1                 |
| 41.28 | Set 2 setpoint increase time | Real          | 0.0 ... 1800.0       | s               | 10 = 1 s                |
| 41.29 | Set 2 setpoint decrease time | Real          | 0.0 ... 1800.0       | s               | 10 = 1 s                |
| 41.30 | Set 2 setpoint freeze enable | Binary<br>src | -                    | -               | 1 = 1                   |
| 41.31 | Set 2 deviation inversion    | Binary<br>src | -                    | -               | 1 = 1                   |
| 41.32 | Set 2 gain                   | Real          | 0.1 ... 100.0        | -               | 100 = 1                 |
| 41.33 | Set 2 integration time       | Real          | 0.0 ... 3600.0       | s               | 10 = 1 s                |
| 41.34 | Set 2 derivation time        | Real          | 0.0 ... 10.0         | s               | 1000 = 1 s              |
| 41.35 | Set 2 derivation filter time | Real          | 0.0 ... 10.0         | s               | 10 = 1 s                |
| 41.36 | Set 2 output min             | Real          | -32768.0 ... 32767.0 | -               | 10 = 1                  |
| 41.37 | Set 2 output max             | Real          | -32768.0 ... 32767.0 | -               | 10 = 1                  |
| 41.38 | Set 2 output freeze enable   | Binary<br>src | -                    | -               | 1 = 1                   |
| 41.39 | Set 2 deadband range         | Real          | 0.0 ... 32767.0      | -               | 10 = 1                  |
| 41.40 | Set 2 deadband delay         | Real          | 0.0 ... 3600.0       | s               | 10 = 1 s                |
| 41.41 | Set 2 sleep mode             | List          | 0...2                | -               | 1 = 1                   |
| 41.42 | Set 2 sleep enable           | Binary<br>src | -                    | -               | 1 = 1                   |

## 466 Additional parameter data

| No.                                | Name                         | Type              | Range                  | Unit         | FbEq32               |
|------------------------------------|------------------------------|-------------------|------------------------|--------------|----------------------|
| 41.43                              | Set 2 sleep level            | <i>Real</i>       | 0.0 ... 32767.0        | -            | 10 = 1               |
| 41.44                              | Set 2 sleep delay            | <i>Real</i>       | 0.0 ... 3600.0         | s            | 10 = 1 s             |
| 41.45                              | Set 2 sleep boost time       | <i>Real</i>       | 0.0 ... 3600.0         | s            | 10 = 1 s             |
| 41.46                              | Set 2 sleep boost step       | <i>Real</i>       | 0.0 ... 32767.0        | -            | 10 = 1               |
| 41.47                              | Set 2 wake-up deviation      | <i>Real</i>       | -32768.00 ... 32767.00 | rpm, % or Hz | 100 = 1 rpm, % or Hz |
| 41.48                              | Set 2 wake-up delay          | <i>Real</i>       | 0.00 ... 60.00         | s            | 100 = 1 s            |
| 41.49                              | Set 2 tracking mode          | <i>Binary src</i> | -                      | -            | 1 = 1                |
| 41.50                              | Set 2 tracking ref selection | <i>Analog src</i> | -                      | -            | 1 = 1                |
| 41.51                              | Set 2 trim mode              | <i>List</i>       | 0...3                  | -            | 1 = 1                |
| 41.52                              | Set 2 trim selection         | <i>List</i>       | 1...3                  | -            | 1 = 1                |
| 41.53                              | Set 2 trimmed ref pointer    | <i>Analog src</i> | -                      | -            | 1 = 1                |
| 41.54                              | Set 2 trim mix               | <i>Real</i>       | 0.000 ... 1.000        | -            | 1000 = 1             |
| 41.55                              | Set 2 trim adjust            | <i>Real</i>       | -100.000 ... 100.000   | -            | 1000 = 1             |
| 41.56                              | Set 2 trim source            | <i>List</i>       | 1...2                  | -            | 1 = 1                |
| 41.60                              | Set 2 PID activation source  | <i>Binary src</i> | -                      | -            | 1 = 1                |
| <b>43 Brake chopper</b>            |                              |                   |                        |              |                      |
| 43.01                              | Braking resistor temperature | <i>Real</i>       | 0.0 ... 120.0          | %            | 10 = 1%              |
| 43.06                              | Brake chopper function       | <i>List</i>       | 0...3                  | -            | 1 = 1                |
| 43.07                              | Brake chopper run enable     | <i>Binary src</i> | -                      | -            | 1 = 1                |
| 43.08                              | Brake resistor thermal tc    | <i>Real</i>       | 0...10000              | s            | 1 = 1 s              |
| 43.09                              | Brake resistor Pmax cont     | <i>Real</i>       | 0.00 ... 10000.00      | kW           | 100 = 1 kW           |
| 43.10                              | Brake resistance             | <i>Real</i>       | 0.0 ... 1000.0         | ohm          | 10 = 1 ohm           |
| 43.11                              | Brake resistor fault limit   | <i>Real</i>       | 0...150                | %            | 1 = 1%               |
| 43.12                              | Brake resistor warning limit | <i>Real</i>       | 0...150                | %            | 1 = 1%               |
| <b>44 Mechanical brake control</b> |                              |                   |                        |              |                      |
| 44.01                              | Brake control status         | <i>PB</i>         | 00000000b...11111111b  | -            | 1 = 1                |
| 44.02                              | Brake torque memory          | <i>Real</i>       | -1600.0 ... 1600.0     | %            | 10 = 1%              |
| 44.03                              | Brake open torque reference  | <i>Real</i>       | -1600.0 ... 1600.0     | %            | 10 = 1%              |
| 44.06                              | Brake control enable         | <i>Binary src</i> | -                      | -            | 1 = 1                |
| 44.07                              | Brake acknowledge selection  | <i>Binary src</i> | -                      | -            | 1 = 1                |
| 44.08                              | Brake open delay             | <i>Real</i>       | 0.00 ... 5.00          | s            | 100 = 1 s            |
| 44.09                              | Brake open torque source     | <i>Analog src</i> | -                      | -            | 1 = 1                |
| 44.10                              | Brake open torque            | <i>Real</i>       | -1000...1000           | %            | 10 = 1%              |
| 44.11                              | Keep brake closed            | <i>Binary src</i> | -                      | -            | 1 = 1                |

| No.                                   | Name                         | Type              | Range   | Unit            | FbEq32                  |
|---------------------------------------|------------------------------|-------------------|---|-----------------|-------------------------|
| 44.12                                 | Brake close request          | <i>Binary src</i> | -   | -               | 1 = 1                   |
| 44.13                                 | Brake close delay            | <i>Real</i>       | 0.00 ... 60.00                                  | s               | 100 = 1 s               |
| 44.14                                 | Brake close level            | <i>Real</i>       | 0.0 ... 1000.0                                  | rpm             | 100 = 1 rpm             |
| 44.15                                 | Brake close level delay      | <i>Real</i>       | 0.00 ... 10.00                                  | s               | 100 = 1 s               |
| 44.16                                 | Brake reopen delay           | <i>Real</i>       | 0.00 ... 10.00                                  | s               | 100 = 1 s               |
| 44.17                                 | Brake fault function         | <i>List</i>       | 0...2   | -               | 1 = 1                   |
| 44.18                                 | Brake fault delay            | <i>Real</i>       | 0.00 ... 60.00                                  | s               | 100 = 1 s               |
| <b>45 Energy efficiency</b>           |                              |                   |   |                 |                         |
| 45.01                                 | Saved GW hours               | <i>Real</i>       | 0...65535                                       | GWh             | 1 = 1 GWh               |
| 45.02                                 | Saved MW hours               | <i>Real</i>       | 0...999   | MWh             | 1 = 1 MWh               |
| 45.03                                 | Saved kW hours               | <i>Real</i>       | 0.0 ... 999.0                                   | kWh             | 10 = 1 kWh              |
| 45.05                                 | Saved money x1000            | <i>Real</i>       | 0...4294967295                                  | thousand        | 1 = 1 thousand          |
| 45.06                                 | Saved money                  | <i>Real</i>       | 0.00 ... 999.99                                 | (selectable)    | 100 = 1 unit            |
| 45.08                                 | CO2 reduction in kilotons    | <i>Real</i>       | 0...65535                                       | metric kiloton  | 1 = 1 metric kiloton    |
| 45.09                                 | CO2 reduction in tons        | <i>Real</i>       | 0.0 ... 999.9                                   | metric ton      | 10 = 1 metric ton       |
| 45.11                                 | Energy optimizer             | <i>List</i>       | 0...1   | -               | 1 = 1                   |
| 45.12                                 | Energy tariff 1              | <i>Real</i>       | 0.000 ... 4294967.295                           | (selectable)    | 1000 = 1 unit           |
| 45.13                                 | Energy tariff 2              | <i>Real</i>       | 0.000 ... 4294967.295                           | (selectable)    | 1000 = 1 unit           |
| 45.14                                 | Tariff selection             | <i>Binary src</i> | -   | -               | 1 = 1                   |
| 45.17                                 | Tariff currency unit         | <i>List</i>       | 100...102                                       | -               | 1 = 1                   |
| 45.18                                 | CO2 conversion factor        | <i>Real</i>       | 0.000 ... 65.535                                | metric ton/ MWh | 1000 = 1 metric ton/MWh |
| 45.19                                 | Comparison power             | <i>Real</i>       | 0.0 ... 100000.0                                | kW              | 10 = 1 kW               |
| 45.21                                 | Energy calculations reset    | <i>List</i>       | 0...1   | -               | 1 = 1                   |
| <b>46 Monitoring/scaling settings</b> |                              |                   |   |                 |                         |
| 46.01                                 | Speed scaling                | <i>Real</i>       | 0.10 ... 30000.00                               | rpm             | 100 = 1 rpm             |
| 46.02                                 | Frequency scaling            | <i>Real</i>       | 0.10 ... 1000.00                                | Hz              | 100 = 1 Hz              |
| 46.03                                 | Torque scaling               | <i>Real</i>       | 0.1 ... 1000.0                                  | %               | 10 = 1%                 |
| 46.04                                 | Power scaling                | <i>Real</i>       | 0.10 ... 30000.00 kW or<br>0.10 ... 40214.48 hp | kW or hp        | 100 = 1 unit            |
| 46.05                                 | Current scaling              | <i>Real</i>       | 0...30000                                       | A               | 1 = 1 A                 |
| 46.06                                 | Speed ref zero scaling       | <i>Real</i>       | 0.00 ... 30000.00                               | rpm             | 100 = 1 rpm             |
| 46.07                                 | Frequency ref zero scaling   | <i>Real</i>       | 0.00 ... 1000.00                                | Hz              | 100 = 1 Hz              |
| 46.11                                 | Filter time motor speed      | <i>Real</i>       | 0...20000                                       | ms              | 1 = 1 ms                |
| 46.12                                 | Filter time output frequency | <i>Real</i>       | 0...20000                                       | ms              | 1 = 1 ms                |
| 46.13                                 | Filter time motor torque     | <i>Real</i>       | 0...20000                                       | ms              | 1 = 1 ms                |

468 Additional parameter data

| No.                    | Name                       | Type        | Range                            | Unit | FbEq32      |
|------------------------|----------------------------|-------------|----------------------------------|------|-------------|
| 46.14                  | Filter time power out      | <i>Real</i> | 0...20000                        | ms   | 1 = 1 ms    |
| 46.21                  | At speed hysteresis        | <i>Real</i> | 0.00 ... 30000.00                | rpm  | 100 = 1 rpm |
| 46.22                  | At frequency hysteresis    | <i>Real</i> | 0.00 ... 1000.00                 | Hz   | 100 = 1 Hz  |
| 46.23                  | At torque hysteresis       | <i>Real</i> | 0.0 ... 300.0                    | %    | 1 = 1%      |
| 46.31                  | Above speed limit          | <i>Real</i> | 0.00 ... 30000.00                | rpm  | 100 = 1 rpm |
| 46.32                  | Above frequency limit      | <i>Real</i> | 0.00 ... 1000.00                 | Hz   | 100 = 1 Hz  |
| 46.33                  | Above torque limit         | <i>Real</i> | 0.0 ... 1600.0                   | %    | 10 = 1%     |
| 46.42                  | Torque decimals            | <i>List</i> | 0...2                            | -    | 1 = 1       |
| <b>47 Data storage</b> |                            |             |                                  |      |             |
| 47.01                  | Data storage 1 real32      | <i>Real</i> | Defined by <a href="#">47.31</a> | -    | 1000 = 1    |
| 47.02                  | Data storage 2 real32      | <i>Real</i> | Defined by <a href="#">47.32</a> | -    | 1000 = 1    |
| 47.03                  | Data storage 3 real32      | <i>Real</i> | Defined by <a href="#">47.33</a> | -    | 1000 = 1    |
| 47.04                  | Data storage 4 real32      | <i>Real</i> | Defined by <a href="#">47.34</a> | -    | 1000 = 1    |
| 47.05                  | Data storage 5 real32      | <i>Real</i> | Defined by <a href="#">47.35</a> | -    | 1000 = 1    |
| 47.06                  | Data storage 6 real32      | <i>Real</i> | Defined by <a href="#">47.36</a> | -    | 1000 = 1    |
| 47.07                  | Data storage 7 real32      | <i>Real</i> | Defined by <a href="#">47.37</a> | -    | 1000 = 1    |
| 47.08                  | Data storage 8 real32      | <i>Real</i> | Defined by <a href="#">47.38</a> | -    | 1000 = 1    |
| 47.11                  | Data storage 1 int32       | <i>Real</i> | -2147483648 ...<br>2147483647    | -    | 1 = 1       |
| 47.12                  | Data storage 2 int32       | <i>Real</i> | -2147483648 ...<br>2147483647    | -    | 1 = 1       |
| 47.13                  | Data storage 3 int32       | <i>Real</i> | -2147483648 ...<br>2147483647    | -    | 1 = 1       |
| 47.14                  | Data storage 4 int32       | <i>Real</i> | -2147483648 ...<br>2147483647    | -    | 1 = 1       |
| 47.15                  | Data storage 5 int32       | <i>Real</i> | -2147483648 ...<br>2147483647    | -    | 1 = 1       |
| 47.16                  | Data storage 6 int32       | <i>Real</i> | -2147483648 ...<br>2147483647    | -    | 1 = 1       |
| 47.17                  | Data storage 7 int32       | <i>Real</i> | -2147483648 ...<br>2147483647    | -    | 1 = 1       |
| 47.18                  | Data storage 8 int32       | <i>Real</i> | -2147483648 ...<br>2147483647    | -    | 1 = 1       |
| 47.21                  | Data storage 1 int16       | <i>Real</i> | -32768 ... 32767                 | -    | 1 = 1       |
| 47.22                  | Data storage 2 int16       | <i>Real</i> | -32768 ... 32767                 | -    | 1 = 1       |
| 47.23                  | Data storage 3 int16       | <i>Real</i> | -32768 ... 32767                 | -    | 1 = 1       |
| 47.24                  | Data storage 4 int16       | <i>Real</i> | -32768 ... 32767                 | -    | 1 = 1       |
| 47.25                  | Data storage 5 int16       | <i>Real</i> | -32768 ... 32767                 | -    | 1 = 1       |
| 47.26                  | Data storage 6 int16       | <i>Real</i> | -32768 ... 32767                 | -    | 1 = 1       |
| 47.27                  | Data storage 7 int16       | <i>Real</i> | -32768 ... 32767                 | -    | 1 = 1       |
| 47.28                  | Data storage 8 int16       | <i>Real</i> | -32768 ... 32767                 | -    | 1 = 1       |
| 47.31                  | Data storage 1 real32 type | <i>List</i> | 0...5                            | -    | 1 = 1       |
| 47.32                  | Data storage 2 real32 type | <i>List</i> | 0...5                            | -    | 1 = 1       |
| 47.33                  | Data storage 3 real32 type | <i>List</i> | 0...5                            | -    | 1 = 1       |

| No.                                | Name                            | Type              | Range                      | Unit | FbEq32      |
|------------------------------------|---------------------------------|-------------------|----------------------------|------|-------------|
| 47.34                              | Data storage 4 real32 type      | <i>List</i>       | 0...5                      | -    | 1 = 1       |
| 47.35                              | Data storage 5 real32 type      | <i>List</i>       | 0...5                      | -    | 1 = 1       |
| 47.36                              | Data storage 6 real32 type      | <i>List</i>       | 0...5                      | -    | 1 = 1       |
| 47.37                              | Data storage 7 real32 type      | <i>List</i>       | 0...5                      | -    | 1 = 1       |
| 47.38                              | Data storage 8 real32 type      | <i>List</i>       | 0...5                      | -    | 1 = 1       |
| <b>49 Panel port communication</b> |                                 |                   |                            |      |             |
| 49.01                              | Node ID number                  | <i>Real</i>       | 1...32                     | -    | 1 = 1       |
| 49.03                              | Baud rate                       | <i>List</i>       | 1...5                      | -    | 1 = 1       |
| 49.04                              | Communication loss time         | <i>Real</i>       | 0.3 ... 3000.0             | s    | 10 = 1 s    |
| 49.05                              | Communication loss action       | <i>List</i>       | 0...5                      | -    | 1 = 1       |
| 49.06                              | Refresh settings                | <i>List</i>       | 0...1                      | -    | 1 = 1       |
| 49.07                              | Panel comm supervision force    | <i>PB</i>         | 0000h...FFFFh              | -    | 1 = 1       |
| 49.08                              | Secondary comm. loss action     | <i>List</i>       | 0...5                      | -    | 1 = 1       |
| 49.14                              | Panel speed reference unit      | <i>List</i>       | 0...1                      | -    | 1 = 1       |
| 49.15                              | Minimum ext speed ref panel     | <i>Real</i>       | -30000.00 ... 30000.00     | rpm  | 100 = 1 rpm |
| 49.16                              | Maximum ext speed ref panel     | <i>Real</i>       | -30000.00 ... 30000.00     | rpm  | 100 = 1 rpm |
| 49.17                              | Minimum ext frequency ref panel | <i>Real</i>       | -500.00 ... 500.00         | Hz   | 100 = 1 Hz  |
| 49.18                              | Maximum ext frequency ref panel | <i>Real</i>       | -500.00 ... 500.00         | Hz   | 100 = 1 Hz  |
| 49.24                              | Panel actual source             | <i>Analog src</i> | -                          | -    | 1 = 1       |
| <b>50 Fieldbus adapter (FBA)</b>   |                                 |                   |                            |      |             |
| 50.01                              | FBA A enable                    | <i>List</i>       | 0...3                      | -    | 1 = 1       |
| 50.02                              | FBA A comm loss func            | <i>List</i>       | 0...5                      | -    | 1 = 1       |
| 50.03                              | FBA A comm loss t out           | <i>Real</i>       | 0.3 ... 6553.5             | s    | 10 = 1 s    |
| 50.04                              | FBA A ref1 type                 | <i>List</i>       | 0...5                      | -    | 1 = 1       |
| 50.05                              | FBA A ref2 type                 | <i>List</i>       | 0...5                      | -    | 1 = 1       |
| 50.07                              | FBA A actual 1 type             | <i>List</i>       | 0...6                      | -    | 1 = 1       |
| 50.08                              | FBA A actual 2 type             | <i>List</i>       | 0...6                      | -    | 1 = 1       |
| 50.09                              | FBA A SW transparent source     | <i>Analog src</i> | -                          | -    | 1 = 1       |
| 50.10                              | FBA A act1 transparent source   | <i>Analog src</i> | -                          | -    | 1 = 1       |
| 50.11                              | FBA A act2 transparent source   | <i>Analog src</i> | -                          | -    | 1 = 1       |
| 50.12                              | FBA A debug mode                | <i>List</i>       | 0...1                      | -    | 1 = 1       |
| 50.13                              | FBA A control word              | <i>Data</i>       | 00000000h ... FFFFFFFFh    | -    | 1 = 1       |
| 50.14                              | FBA A reference 1               | <i>Real</i>       | -2147483648 ... 2147483647 | -    | 1 = 1       |
| 50.15                              | FBA A reference 2               | <i>Real</i>       | -2147483648 ... 2147483647 | -    | 1 = 1       |
| 50.16                              | FBA A status word               | <i>Data</i>       | 00000000h ... FFFFFFFFh    | -    | 1 = 1       |

470 Additional parameter data

| No.                      | Name                          | Type                  | Range                         | Unit | FbEq32   |
|--------------------------|-------------------------------|-----------------------|-------------------------------|------|----------|
| 50.17                    | FBA A actual value 1          | <i>Real</i>           | -2147483648 ...<br>2147483647 | -    | 1 = 1    |
| 50.18                    | FBA A actual value 2          | <i>Real</i>           | -2147483648 ...<br>2147483647 | -    | 1 = 1    |
| 50.21                    | FBA A timelevel sel           | <i>List</i>           | 0...3                         | -    | 1 = 1    |
| 50.26                    | FBA A comm supervision force  | <i>PB</i>             | 0000h...FFFFh                 | -    | 1 = 1    |
| 50.31                    | FBA B enable                  | <i>List</i>           | 0...1                         | -    | 1 = 1    |
| 50.32                    | FBA B comm loss func          | <i>Real</i>           | 0...5                         | -    | 1 = 1    |
| 50.33                    | FBA B comm loss timeout       | <i>List</i>           | 0.3 ... 6553.5                | s    | 10 = 1 s |
| 50.34                    | FBA B ref1 type               | <i>List</i>           | 0...5                         | -    | 1 = 1    |
| 50.35                    | FBA B ref2 type               | <i>List</i>           | 0...5                         | -    | 1 = 1    |
| 50.37                    | FBA B actual 1 type           | <i>List</i>           | 0...6                         | -    | 1 = 1    |
| 50.38                    | FBA B actual 2 type           | <i>List</i>           | 0...6                         | -    | 1 = 1    |
| 50.39                    | FBA B SW transparent source   | <i>Analog<br/>src</i> | -                             | -    | 1 = 1    |
| 50.40                    | FBA B act1 transparent source | <i>Analog<br/>src</i> | -                             | -    | 1 = 1    |
| 50.41                    | FBA B act2 transparent source | <i>List</i>           | -                             | -    | 1 = 1    |
| 50.42                    | FBA B debug mode              | <i>Data</i>           | 0...1                         | -    | 1 = 1    |
| 50.43                    | FBA B control word            | <i>Real</i>           | 00000000h ... FFFFFFFFh       | -    | 1 = 1    |
| 50.44                    | FBA B reference 1             | <i>Real</i>           | -2147483648 ...<br>2147483647 | -    | 1 = 1    |
| 50.45                    | FBA B reference 2             | <i>Data</i>           | -2147483648 ...<br>2147483647 | -    | 1 = 1    |
| 50.46                    | FBA B status word             | <i>Real</i>           | 00000000h ... FFFFFFFFh       | -    | 1 = 1    |
| 50.47                    | FBA B actual value 1          | <i>Real</i>           | -2147483648 ...<br>2147483647 | -    | 1 = 1    |
| 50.48                    | FBA B actual value 2          |                       | -2147483648 ...<br>2147483647 | -    | 1 = 1    |
| 50.51                    | FBA B timelevel sel           | <i>List</i>           | 0...3                         | -    | 1 = 1    |
| 50.56                    | FBA B comm supervision force  | <i>PB</i>             | 0000h...FFFFh                 | -    | 1 = 1    |
| <b>51 FBA A settings</b> |                               |                       |                               |      |          |
| 51.01                    | FBA A type                    | <i>List</i>           | -                             | -    | 1 = 1    |
| 51.02                    | FBA A Par2                    | <i>Real</i>           | 0...65535                     | -    | 1 = 1    |
| ...                      | ...                           | ...                   | ...                           | ...  |          |
| 51.26                    | FBA A Par26                   | <i>Real</i>           | 0...65535                     | -    | 1 = 1    |
| 51.27                    | FBA A par refresh             | <i>List</i>           | 0...1                         | -    | 1 = 1    |
| 51.28                    | FBA A par table ver           | <i>Data</i>           | -                             | -    | 1 = 1    |
| 51.29                    | FBA A drive type code         | <i>Real</i>           | 0...65535                     | -    | 1 = 1    |
| 51.30                    | FBA A mapping file ver        | <i>Real</i>           | 0...65535                     | -    | 1 = 1    |
| 51.31                    | D2FBA A comm status           | <i>List</i>           | 0...6                         | -    | 1 = 1    |
| 51.32                    | FBA A comm SW ver             | <i>Data</i>           | -                             | -    | 1 = 1    |
| 51.33                    | FBA A appl SW ver             | <i>Data</i>           | -                             | -    | 1 = 1    |

| No.                         | Name                      | Type   | Range          | Unit | FbEq32 |
|-----------------------------|---------------------------|--------|----------------|------|--------|
| <b>52 FBA A data in</b>     |                           |        |                |      |        |
| 52.01                       | FBA A data in1            | List   | -              | -    | 1 = 1  |
| ...                         | ...                       | ...    | ...            | ...  |        |
| 52.12                       | FBA A data in12           | List   | -              | -    | 1 = 1  |
| <b>53 FBA A data out</b>    |                           |        |                |      |        |
| 53.01                       | FBA A data out1           | List   | -              | -    | 1 = 1  |
| ...                         | ...                       | ...    | ...            | ...  |        |
| 53.12                       | FBA A data out12          | List   | -              | -    | 1 = 1  |
| <b>54 FBA B settings</b>    |                           |        |                |      |        |
| 54.01                       | FBA B type                |        |                |      |        |
| 54.02                       | FBA B Par2                | UINT16 | 0...65535      | -    |        |
| ...                         | ...                       | ...    | ...            | ...  |        |
| 54.26                       | FBA B Par26               | UINT16 | 0...65535      | -    |        |
| 54.27                       | FBA B par refresh         | List   | 0...1          | -    |        |
| 54.28                       | FBA B par table ver       | UINT16 | 0...65535      | -    |        |
| 54.29                       | FBA B drive type code     | UINT16 | 0...65535      | -    |        |
| 54.30                       | FBA B mapping file ver    | UINT16 | 0...65535      | -    |        |
| 54.31                       | D2FBA B comm status       | List   | 0...6          | -    |        |
| 54.32                       | FBA B comm SW ver         | UINT16 | 0...65535      | -    |        |
| 54.33                       | FBA B appl SW ver         | UINT16 | 0...65535      | -    |        |
| <b>55 FBA B data in</b>     |                           |        |                |      |        |
| 55.01                       | FBA B data in1            | List   | -              | -    | 1 = 1  |
| ...                         | ...                       | ...    | ...            | ...  |        |
| 55.12                       | FBA B data in12           | List   | -              | -    | 1 = 1  |
| <b>56 FBA B data out</b>    |                           |        |                |      |        |
| 56.01                       | FBA B data out1           | List   | -              | -    | 1 = 1  |
| ...                         | ...                       | ...    | ...            | ...  |        |
| 56.12                       | FBA B data out12          | List   | -              | -    | 1 = 1  |
| <b>58 Embedded fieldbus</b> |                           |        |                |      |        |
| 58.01                       | Protocol enable           | List   | 0...1          | -    | 1 = 1  |
| 58.02                       | Protocol ID               | Real   | 0000h...FFFFh  | -    | 1 = 1  |
| 58.03                       | Node address              | Real   | 0...255        | -    | 1 = 1  |
| 58.04                       | Baud rate                 | List   | 2...7          | -    | 1 = 1  |
| 58.05                       | Parity                    | List   | 0...3          | -    | 1 = 1  |
| 58.06                       | Communication control     | List   | 0...2          | -    | 1 = 1  |
| 58.07                       | Communication diagnostics | PB     | 0000h...FFFFh  | -    | 1 = 1  |
| 58.08                       | Received packets          | Real   | 0...4294967295 | -    | 1 = 1  |
| 58.09                       | Transmitted packets       | Real   | 0...4294967295 | -    | 1 = 1  |
| 58.10                       | All packets               | Real   | 0...4294967295 | -    | 1 = 1  |
| 58.11                       | UART errors               | Real   | 0...4294967295 | -    | 1 = 1  |
| 58.12                       | CRC errors                | Real   | 0...4294967295 | -    | 1 = 1  |

## 472 Additional parameter data

| No.                          | Name                               | Type              | Range          | Unit | FbEq32   |
|------------------------------|------------------------------------|-------------------|----------------|------|----------|
| 58.14                        | Communication loss action          | <i>List</i>       | 0...5          | -    | 1 = 1    |
| 58.15                        | Communication loss mode            | <i>List</i>       | 1...2          | -    | 1 = 1    |
| 58.16                        | Communication loss time            | <i>Real</i>       | 0.0 ... 6000.0 | s    | 10 = 1 s |
| 58.17                        | Transmit delay                     | <i>Real</i>       | 0...65535      | ms   | 1 = 1 ms |
| 58.18                        | EFB control word                   | <i>PB</i>         | 0000h...FFFFh  | -    | 1 = 1    |
| 58.19                        | EFB status word                    | <i>PB</i>         | 0000h...FFFFh  | -    | 1 = 1    |
| 58.25                        | Control profile                    | <i>List</i>       | 0, 2           | -    | 1 = 1    |
| 58.26                        | EFB ref1 type                      | <i>List</i>       | 0...5          | -    | 1 = 1    |
| 58.27                        | EFB ref2 type                      | <i>List</i>       | 0...5          | -    | 1 = 1    |
| 58.28                        | EFB act1 type                      | <i>List</i>       | 0...6          | -    | 1 = 1    |
| 58.29                        | EFB act2 type                      | <i>List</i>       | 0...6          | -    | 1 = 1    |
| 58.30                        | EFB status word transparent source | <i>Analog src</i> | -              | -    | 1 = 1    |
| 58.31                        | EFB act1 transparent source        | <i>Analog src</i> | -              | -    | 1 = 1    |
| 58.32                        | EFB act2 transparent source        | <i>Analog src</i> | -              | -    | 1 = 1    |
| 58.33                        | Addressing mode                    | <i>List</i>       | 0...2          | -    | 1 = 1    |
| 58.34                        | Word order                         | <i>List</i>       | 0...1          | -    | 1 = 1    |
| 58.36                        | EFB comm supervision force         | <i>PB</i>         | 0000h...FFFFh  | -    | 1 = 1    |
| 58.101                       | Data I/O 1                         | <i>Analog src</i> | -              | -    | 1 = 1    |
| 58.102                       | Data I/O 2                         | <i>Analog src</i> | -              | -    | 1 = 1    |
| 58.103                       | Data I/O 3                         | <i>Analog src</i> | -              | -    | 1 = 1    |
| 58.104                       | Data I/O 4                         | <i>Analog src</i> | -              | -    | 1 = 1    |
| 58.105                       | Data I/O 5                         | <i>Analog src</i> | -              | -    | 1 = 1    |
| 58.106                       | Data I/O 6                         | <i>Analog src</i> | -              | -    | 1 = 1    |
| 58.107                       | Data I/O 7                         | <i>Analog src</i> | -              | -    | 1 = 1    |
| ...                          | ...                                | ...               | ...            | ...  |          |
| 58.124                       | Data I/O 24                        | <i>Analog src</i> | -              | -    | 1 = 1    |
| <b>60 DDCS communication</b> |                                    |                   |                |      |          |
| 60.01                        | M/F communication port             | <i>List</i>       | -              | -    | -        |
| 60.02                        | M/F node address                   | <i>Real</i>       | 1...254        | -    | -        |
| 60.03                        | M/F mode                           | <i>List</i>       | 0...6          | -    | -        |
| 60.05                        | M/F HW connection                  | <i>List</i>       | 0...1          | -    | -        |
| 60.07                        | M/F link control                   | <i>Real</i>       | 1...15         | -    | -        |
| 60.08                        | M/F comm loss timeout              | <i>Real</i>       | 0...65535      | ms   | -        |
| 60.09                        | M/F comm loss function             | <i>List</i>       | 0...3          | -    | -        |



| No.  | Name                                   | Type       | Range         | Unit | FbEq32   |
|--|--|------------|---------------|------|----------|
| 60.10  | M/F ref1 type                          | List       | 0...5         | -    | -        |
| 60.11  | M/F ref2 type                          | List       | 0...5         | -    | -        |
| 60.12  | M/F act1 type                          | List       | 0...5         | -    | -        |
| 60.13  | M/F act2 type                          | List       | 0...5         | -    | -        |
| 60.14  | M/F follower selection                 | Real       | 0...16        | -    | -        |
| 60.15  | Force master                           | Binary src | -             | -    | 1 = 1    |
| 60.16  | Force follower                         | Binary src | -             | -    | 1 = 1    |
| 60.17  | Follower fault action                  | List       | 0...2         | -    | -        |
| 60.18  | Follower enable                        | List       | 0...6         | -    | -        |
| 60.19  | M/F comm supervision sel 1             | PB         | 0000h...FFFFh | -    | 1 = 1    |
| 60.20  | M/F comm supervision sel 2             | PB         | 0000h...FFFFh | -    | 1 = 1    |
| 60.23  | M/F status supervision sel 1           | PB         | 0000h...FFFFh | -    | 1 = 1    |
| 60.24  | M/F status supervision sel 2           | PB         | 0000h...FFFFh | -    | 1 = 1    |
| 60.27  | M/F status supv mode sel 1             | PB         | 0000h...FFFFh | -    | 1 = 1    |
| 60.28  | M/F status supv mode sel 2             | PB         | 0000h...FFFFh | -    | 1 = 1    |
| 60.31  | M/F wake up delay                      | Real       | 0.0 ... 180.0 | s    | 10 = 1 s |
| 60.32  | M/F comm supervision force             | PB         | 0000h...FFFFh | -    | 1 = 1    |
| 60.41  | Extension adapter com port             | List       | -             | -    | -        |
| 60.50  | DDCS controller drive type             | List       | 0...1         | -    | -        |
| 60.51  | DDCS controller comm port              | List       | -             | -    | -        |
| 60.52  | DDCS controller node address           | Real       | 1...254       | -    | -        |
| 60.55  | DDCS controller HW connection          | List       | 0...1         | -    | -        |
| 60.56  | DDCS controller baud rate              | List       | 1, 2, 4, 8    | -    | -        |
| 60.57  | DDCS controller link control           | Real       | 1...15        | -    | -        |
| 60.58  | DDCS controller comm loss time         | Real       | 0...60000     | ms   | -        |
| 60.59  | DDCS controller comm loss function     | List       | 0...5         | -    | -        |
| 60.60  | DDCS controller ref1 type              | List       | 0...5         | -    | -        |
| 60.61  | DDCS controller ref2 type              | List       | 0...5         | -    | -        |
| 60.62  | DDCS controller act1 type              | List       | 0...5         | -    | -        |
| 60.63  | DDCS controller act2 type              | List       | 0...5         | -    | -        |
| 60.64  | Mailbox dataset selection              | List       | 0...1         | -    | -        |
| 60.65  | DDCS controller comm supervision force | PB         | 0000h...FFFFh | -    | 1 = 1    |
| <i>(Parameters 60.71...60.79 only visible when supply unit control activated by 95.20)</i> |  |            |               |      |          |
| 60.71  | INU-LSU communication port             | List       | -             | -    | 1 = 1    |
| 60.77  | INU-LSU link control                   | Real       | 1...15        | -    | -        |
| 60.78  | INU-LSU comm loss timeout              | Real       | 0...65535     | ms   | -        |

474 Additional parameter data

| No.                                  | Name                         | Type              | Range     | Unit | FbEq32 |
|--------------------------------------|------------------------------|-------------------|-----------|------|--------|
| 60.79                                | INU-LSU comm loss function   | <i>Binary src</i> | -         | -    | 1 = 1  |
| <b>61 D2D and DDCS transmit data</b> |                              |                   |           |      |        |
| 61.01                                | M/F data 1 selection         | <i>List</i>       | -         | -    | -      |
| 61.02                                | M/F data 2 selection         | <i>List</i>       | -         | -    | -      |
| 61.03                                | M/F data 3 selection         | <i>List</i>       | -         | -    | -      |
| 61.25                                | M/F data 1 value             | <i>Real</i>       | 0...65535 | -    | -      |
| 61.26                                | M/F data 2 value             | <i>Real</i>       | 0...65535 | -    | -      |
| 61.27                                | M/F data 3 value             | <i>Real</i>       | 0...65535 | -    | -      |
| 61.45                                | Data set 2 data 1 selection  | <i>List</i>       | -         | -    | -      |
| 61.46                                | Data set 2 data 2 selection  | <i>List</i>       | -         | -    | -      |
| 61.47                                | Data set 2 data 3 selection  | <i>List</i>       | -         | -    | -      |
| 61.48                                | Data set 4 data 1 selection  | <i>List</i>       | -         | -    | -      |
| 61.49                                | Data set 4 data 2 selection  | <i>List</i>       | -         | -    | -      |
| 61.50                                | Data set 4 data 3 selection  | <i>List</i>       | -         | -    | -      |
| 61.51                                | Data set 11 data 1 selection | <i>List</i>       | -         | -    | -      |
| 61.52                                | Data set 11 data 2 selection | <i>List</i>       | -         | -    | -      |
| 61.53                                | Data set 11 data 3 selection | <i>List</i>       | -         | -    | -      |
| 61.54                                | Data set 13 data 1 selection | <i>List</i>       | -         | -    | -      |
| 61.55                                | Data set 13 data 2 selection | <i>List</i>       | -         | -    | -      |
| 61.56                                | Data set 13 data 3 selection | <i>List</i>       | -         | -    | -      |
| 61.57                                | Data set 15 data 1 selection | <i>List</i>       | -         | -    | -      |
| 61.58                                | Data set 15 data 2 selection | <i>List</i>       | -         | -    | -      |
| 61.59                                | Data set 15 data 3 selection | <i>List</i>       | -         | -    | -      |
| 61.60                                | Data set 17 data 1 selection | <i>List</i>       | -         | -    | -      |
| 61.61                                | Data set 17 data 2 selection | <i>List</i>       | -         | -    | -      |
| 61.62                                | Data set 17 data 3 selection | <i>List</i>       | -         | -    | -      |
| 61.63                                | Data set 19 data 1 selection | <i>List</i>       | -         | -    | -      |
| 61.64                                | Data set 19 data 2 selection | <i>List</i>       | -         | -    | -      |
| 61.65                                | Data set 19 data 3 selection | <i>List</i>       | -         | -    | -      |
| 61.66                                | Data set 21 data 1 selection | <i>List</i>       | -         | -    | -      |
| 61.67                                | Data set 21 data 2 selection | <i>List</i>       | -         | -    | -      |
| 61.68                                | Data set 21 data 3 selection | <i>List</i>       | -         | -    | -      |
| 61.69                                | Data set 23 data 1 selection | <i>List</i>       | -         | -    | -      |
| 61.70                                | Data set 23 data 2 selection | <i>List</i>       | -         | -    | -      |
| 61.71                                | Data set 23 data 3 selection | <i>List</i>       | -         | -    | -      |
| 61.72                                | Data set 25 data 1 selection | <i>List</i>       | -         | -    | -      |
| 61.73                                | Data set 25 data 2 selection | <i>List</i>       | -         | -    | -      |
| 61.74                                | Data set 25 data 3 selection | <i>List</i>       | -         | -    | -      |
| 61.95                                | Data set 2 data 1 value      | <i>Real</i>       | 0...65535 | -    | -      |
| 61.96                                | Data set 2 data 2 value      | <i>Real</i>       | 0...65535 | -    | -      |

| No.  | Name                             | Type        | Range     | Unit | FbEq32 |
|--|----------------------------------|-------------|-----------|------|--------|
| 61.97  | Data set 2 data 3 value          | <i>Real</i> | 0...65535 | -    | -      |
| 61.98  | Data set 4 data 1 value          | <i>Real</i> | 0...65535 | -    | -      |
| 61.99  | Data set 4 data 2 value          | <i>Real</i> | 0...65535 | -    | -      |
| 61.100   | Data set 4 data 3 value          | <i>Real</i> | 0...65535 | -    | -      |
| 61.101   | Data set 11 data 1 value         | <i>Real</i> | 0...65535 | -    | -      |
| 61.102   | Data set 11 data 2 value         | <i>Real</i> | 0...65535 | -    | -      |
| 61.103   | Data set 11 data 3 value         | <i>Real</i> | 0...65535 | -    | -      |
| 61.104   | Data set 13 data 1 value         | <i>Real</i> | 0...65535 | -    | -      |
| 61.105   | Data set 13 data 2 value         | <i>Real</i> | 0...65535 | -    | -      |
| 61.106   | Data set 13 data 3 value         | <i>Real</i> | 0...65535 | -    | -      |
| 61.107   | Data set 15 data 1 value         | <i>Real</i> | 0...65535 | -    | -      |
| 61.108   | Data set 15 data 2 value         | <i>Real</i> | 0...65535 | -    | -      |
| 61.109   | Data set 15 data 3 value         | <i>Real</i> | 0...65535 | -    | -      |
| 61.110   | Data set 17 data 1 value         | <i>Real</i> | 0...65535 | -    | -      |
| 61.111   | Data set 17 data 2 value         | <i>Real</i> | 0...65535 | -    | -      |
| 61.112   | Data set 17 data 3 value         | <i>Real</i> | 0...65535 | -    | -      |
| 61.113   | Data set 19 data 1 value         | <i>Real</i> | 0...65535 | -    | -      |
| 61.114   | Data set 19 data 2 value         | <i>Real</i> | 0...65535 | -    | -      |
| 61.115   | Data set 19 data 3 value         | <i>Real</i> | 0...65535 | -    | -      |
| 61.116   | Data set 21 data 1 value         | <i>Real</i> | 0...65535 | -    | -      |
| 61.117   | Data set 21 data 2 value         | <i>Real</i> | 0...65535 | -    | -      |
| 61.118   | Data set 21 data 3 value         | <i>Real</i> | 0...65535 | -    | -      |
| 61.119   | Data set 23 data 1 value         | <i>Real</i> | 0...65535 | -    | -      |
| 61.120   | Data set 23 data 2 value         | <i>Real</i> | 0...65535 | -    | -      |
| 61.121   | Data set 23 data 3 value         | <i>Real</i> | 0...65535 | -    | -      |
| 61.122   | Data set 25 data 1 value         | <i>Real</i> | 0...65535 | -    | -      |
| 61.123   | Data set 25 data 2 value         | <i>Real</i> | 0...65535 | -    | -      |
| 61.124   | Data set 25 data 3 value         | <i>Real</i> | 0...65535 | -    | -      |
| <i>(Parameters 61.151...61.203 only visible when supply unit control activated by 95.20)</i> |                                  |             |           |      |        |
| 61.151   | INU-LSU data set 10 data 1 sel   | <i>List</i> | -         | -    | -      |
| 61.152   | INU-LSU data set 10 data 2 sel   | <i>List</i> | -         | -    | -      |
| 61.153   | INU-LSU data set 10 data 3 sel   | <i>List</i> | -         | -    | -      |
| 61.201   | INU-LSU data set 10 data 1 value | <i>Real</i> | 0...65535 | -    | -      |
| 61.202   | INU-LSU data set 10 data 2 value | <i>Real</i> | 0...65535 | -    | -      |
| 61.203   | INU-LSU data set 10 data 3 value | <i>Real</i> | 0...65535 | -    | -      |
| <b>62 D2D and DDCS receive data</b>  |                                  |             |           |      |        |
| 62.01  | M/F data 1 selection             | <i>List</i> | -         | -    | -      |

476 *Additional parameter data*

| No.   | Name                         | Type        | Range         | Unit | FbEq32 |
|-------|------------------------------|-------------|---------------|------|--------|
| 62.02 | M/F data 2 selection         | <i>List</i> | -             | -    | -      |
| 62.03 | M/F data 3 selection         | <i>List</i> | -             | -    | -      |
| 62.04 | Follower node 2 data 1 sel   | <i>List</i> | -             | -    | -      |
| 62.05 | Follower node 2 data 2 sel   | <i>List</i> | -             | -    | -      |
| 62.06 | Follower node 2 data 3 sel   | <i>List</i> | -             | -    | -      |
| 62.07 | Follower node 3 data 1 sel   | <i>List</i> | -             | -    | -      |
| 62.08 | Follower node 3 data 2 sel   | <i>List</i> | -             | -    | -      |
| 62.09 | Follower node 3 data 3 sel   | <i>List</i> | -             | -    | -      |
| 62.10 | Follower node 4 data 1 sel   | <i>List</i> | -             | -    | -      |
| 62.11 | Follower node 4 data 2 sel   | <i>List</i> | -             | -    | -      |
| 62.12 | Follower node 4 data 3 sel   | <i>List</i> | -             | -    | -      |
| 62.25 | MF data 1 value              | <i>Real</i> | 0...65535     | -    | -      |
| 62.26 | MF data 2 value              | <i>Real</i> | 0...65535     | -    | -      |
| 62.27 | MF data 3 value              | <i>Real</i> | 0...65535     | -    | -      |
| 62.28 | Follower node 2 data 1 value | <i>Real</i> | 0...65535     | -    | -      |
| 62.29 | Follower node 2 data 2 value | <i>Real</i> | 0...65535     | -    | -      |
| 62.30 | Follower node 2 data 3 value | <i>Real</i> | 0...65535     | -    | -      |
| 62.31 | Follower node 3 data 1 value | <i>Real</i> | 0...65535     | -    | -      |
| 62.32 | Follower node 3 data 2 value | <i>Real</i> | 0...65535     | -    | -      |
| 62.33 | Follower node 3 data 3 value | <i>Real</i> | 0...65535     | -    | -      |
| 62.34 | Follower node 4 data 1 value | <i>Real</i> | 0...65535     | -    | -      |
| 62.35 | Follower node 4 data 2 value | <i>Real</i> | 0...65535     | -    | -      |
| 62.36 | Follower node 4 data 3 value | <i>Real</i> | 0...65535     | -    | -      |
| 62.37 | M/F communication status 1   | <i>PB</i>   | 0000h...FFFFh | -    | 1 = 1  |
| 62.38 | M/F communication status 2   | <i>PB</i>   | 0000h...FFFFh | -    | 1 = 1  |
| 62.41 | M/F follower ready status 1  | <i>PB</i>   | 0000h...FFFFh | -    | 1 = 1  |
| 62.42 | M/F follower ready status 2  | <i>PB</i>   | 0000h...FFFFh | -    | 1 = 1  |
| 62.45 | Data set 1 data 1 selection  | <i>List</i> | -             | -    | -      |
| 62.46 | Data set 1 data 2 selection  | <i>List</i> | -             | -    | -      |
| 62.47 | Data set 1 data 3 selection  | <i>List</i> | -             | -    | -      |
| 62.48 | Data set 3 data 1 selection  | <i>List</i> | -             | -    | -      |
| 62.49 | Data set 3 data 2 selection  | <i>List</i> | -             | -    | -      |
| 62.50 | Data set 3 data 3 selection  | <i>List</i> | -             | -    | -      |
| 62.51 | Data set 10 data 1 selection | <i>List</i> | -             | -    | -      |
| 62.52 | Data set 10 data 2 selection | <i>List</i> | -             | -    | -      |
| 62.53 | Data set 10 data 3 selection | <i>List</i> | -             | -    | -      |
| 62.54 | Data set 12 data 1 selection | <i>List</i> | -             | -    | -      |
| 62.55 | Data set 12 data 2 selection | <i>List</i> | -             | -    | -      |
| 62.56 | Data set 12 data 3 selection | <i>List</i> | -             | -    | -      |
| 62.57 | Data set 14 data 1 selection | <i>List</i> | -             | -    | -      |
| 62.58 | Data set 14 data 2 selection | <i>List</i> | -             | -    | -      |

| No.    | Name                         | Type | Range     | Unit | FbEq32 |
|--------|------------------------------|------|-----------|------|--------|
| 62.59  | Data set 14 data 3 selection | List | -         | -    | -      |
| 62.60  | Data set 16 data 1 selection | List | -         | -    | -      |
| 62.61  | Data set 16 data 2 selection | List | -         | -    | -      |
| 62.62  | Data set 16 data 3 selection | List | -         | -    | -      |
| 62.63  | Data set 18 data 1 selection | List | -         | -    | -      |
| 62.64  | Data set 18 data 2 selection | List | -         | -    | -      |
| 62.65  | Data set 18 data 3 selection | List | -         | -    | -      |
| 62.66  | Data set 20 data 1 selection | List | -         | -    | -      |
| 62.67  | Data set 20 data 2 selection | List | -         | -    | -      |
| 62.68  | Data set 20 data 3 selection | List | -         | -    | -      |
| 62.69  | Data set 22 data 1 selection | List | -         | -    | -      |
| 62.70  | Data set 22 data 2 selection | List | -         | -    | -      |
| 62.71  | Data set 22 data 3 selection | List | -         | -    | -      |
| 62.72  | Data set 24 data 1 selection | List | -         | -    | -      |
| 62.73  | Data set 24 data 2 selection | List | -         | -    | -      |
| 62.74  | Data set 24 data 3 selection | List | -         | -    | -      |
| 62.95  | Data set 1 data 1 value      | Real | 0...65535 | -    | -      |
| 62.96  | Data set 1 data 2 value      | Real | 0...65535 | -    | -      |
| 62.97  | Data set 1 data 3 value      | Real | 0...65535 | -    | -      |
| 62.98  | Data set 3 data 1 value      | Real | 0...65535 | -    | -      |
| 62.99  | Data set 3 data 2 value      | Real | 0...65535 | -    | -      |
| 62.100 | Data set 3 data 3 value      | Real | 0...65535 | -    | -      |
| 62.101 | Data set 10 data 1 value     | Real | 0...65535 | -    | -      |
| 62.102 | Data set 10 data 2 value     | Real | 0...65535 | -    | -      |
| 62.103 | Data set 10 data 3 value     | Real | 0...65535 | -    | -      |
| 62.104 | Data set 12 data 1 value     | Real | 0...65535 | -    | -      |
| 62.105 | Data set 12 data 2 value     | Real | 0...65535 | -    | -      |
| 62.106 | Data set 12 data 3 value     | Real | 0...65535 | -    | -      |
| 62.107 | Data set 14 data 1 value     | Real | 0...65535 | -    | -      |
| 62.108 | Data set 14 data 2 value     | Real | 0...65535 | -    | -      |
| 62.109 | Data set 14 data 3 value     | Real | 0...65535 | -    | -      |
| 62.110 | Data set 16 data 1 value     | Real | 0...65535 | -    | -      |
| 62.111 | Data set 16 data 2 value     | Real | 0...65535 | -    | -      |
| 62.112 | Data set 16 data 3 value     | Real | 0...65535 | -    | -      |
| 62.113 | Data set 18 data 1 value     | Real | 0...65535 | -    | -      |
| 62.114 | Data set 18 data 2 value     | Real | 0...65535 | -    | -      |
| 62.115 | Data set 18 data 3 value     | Real | 0...65535 | -    | -      |
| 62.116 | Data set 20 data 1 value     | Real | 0...65535 | -    | -      |
| 62.117 | Data set 20 data 2 value     | Real | 0...65535 | -    | -      |
| 62.118 | Data set 20 data 3 value     | Real | 0...65535 | -    | -      |
| 62.119 | Data set 22 data 1 value     | Real | 0...65535 | -    | -      |

478 Additional parameter data

| No.  | Name                             | Type        | Range                        | Unit | FbEq32            |
|--|----------------------------------|-------------|------------------------------|------|-------------------|
| 62.120   | Data set 22 data 2 value         | <i>Real</i> | 0...65535                    | -    | -                 |
| 62.121   | Data set 22 data 3 value         | <i>Real</i> | 0...65535                    | -    | -                 |
| 62.122   | Data set 24 data 1 value         | <i>Real</i> | 0...65535                    | -    | -                 |
| 62.123   | Data set 24 data 2 value         | <i>Real</i> | 0...65535                    | -    | -                 |
| 62.124   | Data set 24 data 3 value         | <i>Real</i> | 0...65535                    | -    | -                 |
| <i>(Parameters 62.151...62.203 only visible when supply unit control activated by 95.20)</i> |                                  |             |                              |      |                   |
| 62.151   | INU-LSU data set 11 data 1 sel   | <i>Real</i> | <i>List</i>                  | -    | -                 |
| 62.152   | INU-LSU data set 11 data 2 sel   | <i>Real</i> | <i>List</i>                  | -    | -                 |
| 62.153   | INU-LSU data set 11 data 3 sel   | <i>Real</i> | <i>List</i>                  | -    | -                 |
| 62.201   | INU-LSU data set 11 data 1 value | <i>Real</i> | 0...65535                    | -    | -                 |
| 62.202   | INU-LSU data set 11 data 2 value | <i>Real</i> | 0...65535                    | -    | -                 |
| 62.203   | INU-LSU data set 11 data 3 value | <i>Real</i> | 0...65535                    | -    | -                 |
| <b>90 Feedback selection</b>   |                                  |             |                              |      |                   |
| 90.01  | Motor speed for control          | <i>Real</i> | -32768.00 ... 32767.00       | rpm  | 100 = 1 rpm       |
| 90.02  | Motor position                   | <i>Real</i> | 0.00000000 ... 1.00000000    | rev  | 100000000 = 1 rev |
| 90.03  | Load speed                       | <i>Real</i> | -32768.00 ... 32767.00       | rpm  | 100 = 1 rpm       |
| 90.04  | Load position                    | <i>Real</i> | -2147483648 ... 2147483647   | -    | 1 = 1             |
| 90.05  | Load position scaled             | <i>Real</i> | -2147483.648 ... 2147483.647 | -    | 100000 = 1        |
| 90.06  | Motor position scaled            | <i>Real</i> | -2147483.648 ... 2147483.647 | -    | 1000 = 1          |
| 90.07  | Load position scaled int         | <i>Real</i> | -2147483648 ... 2147483647   | -    | 1 = 1             |
| 90.10  | Encoder 1 speed                  | <i>Real</i> | -32768.00 ... 32767.00       | rpm  | 100 = 1 rpm       |
| 90.11  | Encoder 1 position               | <i>Real</i> | 0.00000000 ... 1.00000000    | rev  | 100000000 = 1 rev |
| 90.12  | Encoder 1 multiturn revolutions  | <i>Real</i> | 0...16777215                 | -    | 1 = 1             |
| 90.13  | Encoder 1 revolution extension   | <i>Real</i> | -2147483648 ... 2147483647   | -    | 1 = 1             |
| 90.14  | Encoder 1 position raw           | <i>Real</i> | 0...16777215                 | -    | 1 = 1             |
| 90.15  | Encoder 1 revolutions raw        | <i>Real</i> | 0...16777215                 | -    | 1 = 1             |
| 90.20  | Encoder 2 speed                  | <i>Real</i> | -32768.00 ... 32767.00       | rpm  | 100 = 1 rpm       |
| 90.21  | Encoder 2 position               | <i>Real</i> | 0.00000000 ... 1.00000000    | rev  | 100000000 = 1 rev |
| 90.22  | Encoder 2 multiturn revolutions  | <i>Real</i> | 0...16777215                 | -    | 1 = 1             |
| 90.23  | Encoder 2 revolution extension   | <i>Real</i> | -2147483648 ... 2147483647   | -    | 1 = 1             |
| 90.24  | Encoder 2 position raw           | <i>Real</i> | 0...16777215                 | -    | 1 = 1             |
| 90.25  | Encoder 2 revolutions raw        | <i>Real</i> | 0...16777215                 | -    | 1 = 1             |

| No.   | Name                               | Type              | Range                           | Unit | FbEq32    |
|-------|------------------------------------|-------------------|---------------------------------|------|-----------|
| 90.26 | Motor revolution extension         | <i>Real</i>       | -2147483648 ...<br>2147483647   | -    | 1 = 1     |
| 90.27 | Load revolution extension          | <i>Real</i>       | -2147483648 ...<br>2147483647   | -    | 1 = 1     |
| 90.35 | Pos counter status                 | <i>PB</i>         | 000000b...111111b               | -    | 1 = 1     |
| 90.38 | Pos counter decimals               | <i>List</i>       | 0...9                           | -    | 1 = 1     |
| 90.41 | Motor feedback selection           | <i>List</i>       | 0...2                           | -    | 1 = 1     |
| 90.42 | Motor speed filter time            | <i>Real</i>       | 0...10000                       | ms   | 1 = 1 ms  |
| 90.43 | Motor gear numerator               | <i>Real</i>       | -32768...32767                  | -    | 1 = 1     |
| 90.44 | Motor gear denominator             | <i>Real</i>       | -32768...32767                  | -    | 1 = 1     |
| 90.45 | Motor feedback fault               | <i>List</i>       | 0...1                           | -    | 1 = 1     |
| 90.46 | Force open loop                    | <i>List</i>       | 0...1                           | -    | 1 = 1     |
| 90.48 | Motor position axis mode           | <i>List</i>       | 0...1                           | -    | 1 = 1     |
| 90.49 | Motor position resolution          | <i>Real</i>       | 0...31                          | -    | 1 = 1     |
| 90.51 | Load feedback selection            | <i>List</i>       | 0...4                           | -    | 1 = 1     |
| 90.52 | Load speed filter time             | <i>Real</i>       | 0...10000                       | ms   | 1 = 1 ms  |
| 90.53 | Load gear numerator                | <i>Real</i>       | -2147483648 ...<br>2147483647   | -    | 1 = 1     |
| 90.54 | Load gear denominator              | <i>Real</i>       | -2147483648 ...<br>2147483647   | -    | 1 = 1     |
| 90.55 | Load feedback fault                | <i>List</i>       | 0...1                           | -    | 1 = 1     |
| 90.56 | Load position offset               | <i>Real</i>       | -2147483648 ...<br>2147483647   | rev  | 1 = 1 rev |
| 90.57 | Load position resolution           | <i>Real</i>       | 0...31                          | -    | 1 = 1     |
| 90.58 | Pos counter init value int         | <i>Real</i>       | -2147483648 ...<br>2147483647   | -    | 1 = 1     |
| 90.59 | Pos counter init value int source  | <i>Binary src</i> | -                               | -    | 1 = 1     |
| 90.60 | Pos counter error and boot action  | <i>List</i>       | 0...1                           | -    | 1 = 1     |
| 90.61 | Gear numerator                     | <i>Real</i>       | -2147483648 ...<br>2147483647   | -    | 1 = 1     |
| 90.62 | Gear denominator                   | <i>Real</i>       | -2147483648 ...<br>2147483647   | -    | 1 = 1     |
| 90.63 | Feed constant numerator            | <i>Real</i>       | -2147483648 ...<br>2147483647   | -    | 1 = 1     |
| 90.64 | Feed constant denominator          | <i>Real</i>       | -2147483648 ...<br>2147483647   | -    | 1 = 1     |
| 90.65 | Pos counter init value             | <i>Real</i>       | -2147483.648 ...<br>2147483.647 | -    | 1 = 1     |
| 90.66 | Pos counter init value source      | <i>Binary src</i> | -                               | -    | 1 = 1     |
| 90.67 | Pos counter init cmd source        | <i>Binary src</i> | -                               | -    | 1 = 1     |
| 90.68 | Disable pos counter initialization | <i>Binary src</i> | -                               | -    | 1 = 1     |

## 480 Additional parameter data

| No.  | Name                             | Type              | Range               | Unit          | FbEq32         |
|--|----------------------------------|-------------------|---------------------|---------------|----------------|
| 90.69  | Reset pos counter init ready     | <i>Binary src</i> | -                   | -             | 1 = 1          |
| <b>91 Encoder module settings</b>  |                                  |                   |                     |               |                |
| 91.01  | FEN DI status                    | <i>PB</i>         | 000000b...111111b   | -             | 1 = 1          |
| 91.02  | Module 1 status                  | <i>List</i>       | -                   | -             | 1 = 1          |
| 91.03  | Module 2 status                  | <i>List</i>       | -                   | -             | 1 = 1          |
| 91.04  | Module 1 temperature             | <i>Real</i>       | 0...1000            | °C, °F or ohm | 1 = 1 unit     |
| 91.06  | Module 2 temperature             | <i>Real</i>       | 0...1000            | °C, °F or ohm | 1 = 1 unit     |
| 91.10  | Encoder parameter refresh        | <i>List</i>       | 0...1               | -             | 1 = 1          |
| 91.11  | Module 1 type                    | <i>List</i>       | 0...4               | -             | 1 = 1          |
| 91.12  | Module 1 location                | <i>Real</i>       | 1...254             | -             | 1 = 1          |
| 91.13  | Module 2 type                    | <i>List</i>       | 0...4               | -             | 1 = 1          |
| 91.14  | Module 2 location                | <i>Real</i>       | 1...254             | -             | 1 = 1          |
| 91.21  | Module 1 temp sensor type        | <i>List</i>       | 0...2               | -             | 1 = 1          |
| 91.22  | Module 1 temp filter time        | <i>Real</i>       | 0...10000           | ms            | 1 = 1 ms       |
| 91.24  | Module 2 temp sensor type        | <i>List</i>       | 0...2               | -             | 1 = 1          |
| 91.25  | Module 2 temp filter time        | <i>Real</i>       | 0...10000           | ms            | 1 = 1 ms       |
| 91.31  | Module 1 TTL output source       | <i>List</i>       | 0...2               | -             | 1 = 1          |
| 91.32  | Module 1 emulation pulses/rev    | <i>Real</i>       | 0...65535           | -             | 1 = 1          |
| 91.33  | Module 1 emulated Z-pulse offset | <i>Real</i>       | 0.00000 ... 1.00000 | rev           | 100000 = 1 rev |
| 91.41  | Module 2 TTL output source       | <i>List</i>       | 0...2               | -             | 1 = 1          |
| 91.42  | Module 2 emulation pulses/rev    | <i>Real</i>       | 0...65535           | -             | 1 = 1          |
| 91.43  | Module 2 emulated Z-pulse offset | <i>Real</i>       | 0.00000 ... 1.00000 | rev           | 100000 = 1 rev |
| <b>92 Encoder 1 configuration</b>  |                                  |                   |                     |               |                |
| 92.01  | Encoder 1 type                   | <i>List</i>       | 0...7               | -             | 1 = 1          |
| 92.02  | Encoder 1 source                 | <i>List</i>       | 1...2               | -             | 1 = 1          |
| <i>Other parameters in this group when a TTL, TTL+ and HTL encoder is selected<br/>(92.16, 92.17, 92.23...92.25 visible depending on encoder type selection)</i> |                                  |                   |                     |               |                |
| 92.10  | Pulses/revolution                | <i>Real</i>       | 0...65535           | -             | 1 = 1          |
| 92.11  | Pulse encoder type               | <i>List</i>       | 0...1               | -             | 1 = 1          |
| 92.12  | Speed calculation mode           | <i>List</i>       | 0...5               | -             | 1 = 1          |
| 92.13  | Position estimation enable       | <i>List</i>       | 0...1               | -             | 1 = 1          |
| 92.14  | Speed estimation enable          | <i>List</i>       | 0...1               | -             | 1 = 1          |
| 92.15  | Transient filter                 | <i>List</i>       | 0...3               | -             | 1 = 1          |
| 92.16  | Encoder 1 supply voltage         | <i>List</i>       | 0...2               | -             | 1 = 1          |
| 92.17  | Accepted pulse freq of encoder 1 | <i>Real</i>       | 0...300             | kHz           | 1 = 1 kHz      |
| 92.21  | Encoder cable fault mode         | <i>List</i>       | 0...3               | -             | 1 = 1          |



| No.  | Name                             | Type        | Range        | Unit | FbEq32    |
|--|----------------------------------|-------------|--------------|------|-----------|
| 92.23  | Maximum pulse waiting time       | <i>Real</i> | 1...200      | ms   | 1 = 1 ms  |
| 92.24  | Pulse edge filtering             | <i>List</i> | 0...2        | -    | 1 = 1     |
| 92.25  | Pulse overfrequency function     | <i>List</i> | 0...1        | -    | 1 = 1     |
| <i>Other parameters in this group when an absolute encoder is selected</i>   |                                  |             |              |      |           |
| 92.10  | Sine/cosine number               | <i>Real</i> | 0...65535    | -    | 1 = 1     |
| 92.11  | Absolute position source         | <i>List</i> | 0...5        | -    | 1 = 1     |
| 92.12  | Zero pulse enable                | <i>List</i> | 0...1        | -    | 1 = 1     |
| 92.13  | Position data width              | <i>Real</i> | 0...32       | -    | 1 = 1     |
| 92.14  | Revolution data width            | <i>Real</i> | 0...32       | -    | 1 = 1     |
| 92.30  | Serial link mode                 | <i>List</i> | 0...2        | -    | 1 = 1     |
| 92.31  | EnDat max calculation time       | <i>List</i> | 0...3        | -    | 1 = 1     |
| 92.32  | SSI cycle time                   | <i>List</i> | 0...5        | -    | 1 = 1     |
| 92.33  | SSI clock cycles                 | <i>Real</i> | 2...127      | -    | 1 = 1     |
| 92.34  | SSI position msb                 | <i>Real</i> | 1...126      | -    | 1 = 1     |
| 92.35  | SSI revolution msb               | <i>Real</i> | 1...126      | -    | 1 = 1     |
| 92.36  | SSI data format                  | <i>List</i> | 0...1        | -    | 1 = 1     |
| 92.37  | SSI baud rate                    | <i>List</i> | 0...5        | -    | 1 = 1     |
| 92.40  | SSI zero phase                   | <i>List</i> | 0...3        | -    | 1 = 1     |
| 92.45  | Hiperface parity                 | <i>List</i> | 0...1        | -    | 1 = 1     |
| 92.46  | Hiperface baud rate              | <i>List</i> | 0...3        | -    | 1 = 1     |
| 92.47  | Hiperface node address           | <i>Real</i> | 0...255      | -    | 1 = 1     |
| <i>Other parameters in this group when a resolver is selected</i>  |                                  |             |              |      |           |
| 92.10  | Excitation signal frequency      | <i>Real</i> | 1...20       | kHz  | 1 = 1 kHz |
| 92.11  | Excitation signal amplitude      | <i>Real</i> | 4.0 ... 12.0 | V    | 10 = 1 V  |
| 92.12  | Resolver polepairs               | <i>List</i> | 1...32       | -    | 1 = 1     |
| <b>93 Encoder 2 configuration</b>  |                                  |             |              |      |           |
| 93.01  | Encoder 2 type                   | <i>List</i> | 0...7        | -    | 1 = 1     |
| 93.02  | Encoder 2 source                 | <i>List</i> | 1...2        | -    | 1 = 1     |
| <i>Other parameters in this group when a TTL, TTL+ and HTL encoder is selected<br/>(93.16, 93.17, 93.23...93.25 visible depending on encoder type selection)</i> |                                  |             |              |      |           |
| 93.10  | Pulses/rev                       | <i>Real</i> | 0...65535    | -    | 1 = 1     |
| 93.11  | Pulse encoder type               | <i>List</i> | 0...1        | -    | 1 = 1     |
| 93.12  | Speed calculation mode           | <i>List</i> | 0...5        | -    | 1 = 1     |
| 93.13  | Position estimation enable       | <i>List</i> | 0...1        | -    | 1 = 1     |
| 93.14  | Speed estimation enable          | <i>List</i> | 0...1        | -    | 1 = 1     |
| 93.15  | Transient filter                 | <i>List</i> | 0...3        | -    | 1 = 1     |
| 93.16  | Encoder 2 supply voltage         | <i>List</i> | 0...2        | -    | 1 = 1     |
| 93.17  | Accepted pulse freq of encoder 2 | <i>Real</i> | 0...300      | kHz  | 1 = 1 kHz |
| 93.21  | Encoder cable fault mode         | <i>List</i> | 0...3        | -    | 1 = 1     |
| 93.23  | Maximum pulse waiting time       | <i>Real</i> | 1...200      | ms   | 1 = 1 ms  |
| 93.24  | Pulse edge filtering             | <i>List</i> | 0...2        | -    | 1 = 1     |

## 482 Additional parameter data

| No.   | Name                          | Type | Range              | Unit | FbEq32      |
|---|-------------------------------|------|--------------------|------|-------------|
| 93.25   | Pulse overfrequency function  | List | 0...1              | -    | 1 = 1       |
| <i>Other parameters in this group when an absolute encoder is selected</i>                      |                               |      |                    |      |             |
| 93.10   | Sine/cosine number            | Real | 0...65535          | -    | 1 = 1       |
| 93.11   | Absolute position source      | List | 0...5              | -    | 1 = 1       |
| 93.12   | Zero pulse enable             | List | 0...1              | -    | 1 = 1       |
| 93.13   | Position data width           | Real | 0...32             | -    | 1 = 1       |
| 93.14   | Revolution data width         | Real | 0...32             | -    | 1 = 1       |
| 93.30   | Serial link mode              | List | 0...2              | -    | 1 = 1       |
| 93.31   | EnDat calc time               | List | 0...3              | -    | 1 = 1       |
| 93.32   | SSI cycle time                | List | 0...5              | -    | 1 = 1       |
| 93.33   | SSI clock cycles              | Real | 2...127            | -    | 1 = 1       |
| 93.34   | SSI position msb              | Real | 1...126            | -    | 1 = 1       |
| 93.35   | SSI revolution msb            | Real | 1...126            | -    | 1 = 1       |
| 93.36   | SSI data format               | List | 0...1              | -    | 1 = 1       |
| 93.37   | SSI baud rate                 | List | 0...5              | -    | 1 = 1       |
| 93.40   | SSI zero phase                | List | 0...3              | -    | 1 = 1       |
| 93.45   | Hiperface parity              | List | 0...1              | -    | 1 = 1       |
| 93.46   | Hiperface baud rate           | List | 0...3              | -    | 1 = 1       |
| 93.47   | Hiperface node address        | Real | 0...255            | -    | 1 = 1       |
| <i>Other parameters in this group when a resolver is selected</i>                               |                               |      |                    |      |             |
| 93.10   | Excitation signal frequency   | Real | 1...20             | kHz  | 1 = 1 kHz   |
| 93.11   | Excitation signal amplitude   | Real | 4.0 ... 12.0       | V    | 10 = 1 V    |
| 93.12   | Resolver polepairs            | List | 1...32             | -    | 1 = 1       |
| <b>94 LSU control</b>   |                               |      |                    |      |             |
| <i>(Group only visible when supply unit control activated by 95.20)</i>                         |                               |      |                    |      |             |
| 94.01   | LSU control                   | List | 0...1              | -    | 1 = 1       |
| 94.02   | LSU panel communication       | List | 0...1              | -    | 1 = 1       |
| 94.10   | LSU max charging time         | Real | 0...65535          | s    | 1 = 1 s     |
| 94.11   | LSU stop delay                | Real | 0.0 ... 3600.0     | s    | 10 = 1 s    |
| <i>(Parameters 94.20...94.32 only visible when IGBT supply unit control activated by 95.20)</i> |                               |      |                    |      |             |
| 94.20   | DC voltage reference          | Real | 0.0 ... 2000.0     | V    | 10 = 1 V    |
| 94.21   | DC voltage ref source         | List | -                  | -    | 1 = 1       |
| 94.22   | User DC voltage reference     | Real | 0.0 ... 2000.0     | V    | 10 = 1 V    |
| 94.30   | Reactive power reference      | Real | -3276.8 ... 3276.7 | kvar | 10 = 1 kvar |
| 94.31   | Reactive power ref source     | List | -                  | -    | 1 = 1       |
| 94.32   | User reactive power reference | Real | -3276.8 ... 3276.7 | kvar | 10 = 1 kvar |
| <i>(Parameters 94.40 and 94.41 only visible when supply unit control activated by 95.20)</i>    |                               |      |                    |      |             |
| 94.40   | Power mot limit on net loss   | Real | 0.00 ... 600.00    | %    | 100 = 1%    |
| 94.41   | Power gen limit on net loss   | Real | -600.00 ... 0.00   | %    | 100 = 1%    |
| <b>95 HW configuration</b>  |                               |      |                    |      |             |
| 95.01   | Supply voltage                | List | 0...6              | -    | 1 = 1       |

| No.  | Name                              | Type       | Range             | Unit | FbEq32   |
|--|-----------------------------------|------------|-------------------|------|----------|
| 95.02  | Adaptive voltage limits           | List       | 0...1             | -    | 1 = 1    |
| 95.04  | Control board supply              | List       | 0...2             | -    | 1 = 1    |
| <i>(Parameter 95.08 only visible with a ZCU control unit)</i>          |                                   |            |                   |      |          |
| 95.08  | DC switch monitoring              | List       | 0...1             | -    | 1 = 1    |
| <i>(Parameters 95.09...95.14 only visible with a BCU control unit)</i> |                                   |            |                   |      |          |
| 95.09  | Switch fuse controller            | List       | 0...1             | -    | 1 = 1    |
| 95.13  | Reduced run mode                  | List       | 0...65535         | -    | 1 = 1    |
| 95.14  | Connected modules                 | PB         | 0000h...FFFFh     | -    | 1 = 1    |
| 95.15  | Special HW settings               | PB         | 0000h...FFFFh     | -    | 1 = 1    |
| 95.20  | HW options word 1                 | PB         | 0000h...FFFFh     | -    | 1 = 1    |
| 95.21  | HW options word 2                 | PB         | 0000h...FFFFh     | -    | 1 = 1    |
| <i>(Parameters 95.30...95.31 only visible with a BCU control unit)</i> |                                   |            |                   |      |          |
| 95.30  | Parallel type filter              | List       | 0...4             | -    | 1 = 1    |
| 95.31  | Parallel connection rating id     | List       | -                 | -    | 1 = 1    |
| 95.40  | Transformation ratio              | Real       | 0.000 ... 100.000 | -    | 1000 = 1 |
| <b>96 System</b>   |                                   |            |                   |      |          |
| 96.01  | Language                          | List       | -                 | -    | 1 = 1    |
| 96.02  | Pass code                         | Data       | 0...99999999      | -    | 1 = 1    |
| 96.03  | Access levels active              | PB         | 0000h...FFFFh     | -    | 1 = 1    |
| 96.04  | Macro select                      | List       | 0...6             | -    | 1 = 1    |
| 96.05  | Macro active                      | List       | 1...6             | -    | 1 = 1    |
| 96.06  | Parameter restore                 | List       | -                 | -    | 1 = 1    |
| 96.07  | Parameter save manually           | List       | 0...1             | -    | 1 = 1    |
| 96.08  | Control board boot                | Real       | 0...1             | -    | 1 = 1    |
| 96.09  | FSO reboot                        | Binary src | -                 | -    | -        |
| 96.10  | User set status                   | List       | -                 | -    | -        |
| 96.11  | User set save/load                | List       | -                 | -    | -        |
| 96.12  | User set I/O mode in1             | Binary src | -                 | -    | -        |
| 96.13  | User set I/O mode in2             | Binary src | -                 | -    | -        |
| 96.16  | Unit selection                    | PB         | 0000h...FFFFh     | -    | 1 = 1    |
| 96.20  | Time sync primary source          | List       | 0...9             | -    | 1 = 1    |
| 96.23  | M/F and D2D clock synchronization | List       | 0...1             | -    | 1 = 1    |
| 96.24  | Full days since 1st Jan 1980      | Real       | 1...59999         | -    | 1 = 1    |
| 96.25  | Time in minutes within 24 h       | Real       | 0...1439          | -    | 1 = 1    |
| 96.26  | Time in ms within one minute      | Real       | 0...59999         | -    | 1 = 1    |
| 96.29  | Time sync source status           | PB         | 0000h...FFFFh     | -    | 1 = 1    |
| 96.31  | Drive ID number                   | Real       | 0...32767         | -    | 1 = 1    |
| 96.39  | Power up event logging            | List       | 0...1             | -    | 1 = 1    |

## 484 Additional parameter data

| No.   | Name                               | Type              | Range                 | Unit | FbEq32     |
|---|------------------------------------|-------------------|-----------------------|------|------------|
| 96.53   | Actual checksum                    | <i>Real</i>       | 00000000h...FFFFFFFFh | -    | 1 = 1      |
| 96.54   | Checksum action                    | <i>List</i>       | 0...4                 | -    | 1 = 1      |
| 96.55   | Checksum control word              | <i>PB</i>         | 0000h...FFFFh         | -    | 1 = 1      |
| 96.56   | Approved checksum 1                | <i>Real</i>       | 00000000h...FFFFFFFFh | -    | 1 = 1      |
| 96.57   | Approved checksum 2                | <i>Real</i>       | 00000000h...FFFFFFFFh | -    | 1 = 1      |
| 96.58   | Approved checksum 3                | <i>Real</i>       | 00000000h...FFFFFFFFh | -    | 1 = 1      |
| 96.59   | Approved checksum 4                | <i>Real</i>       | 00000000h...FFFFFFFFh | -    | 1 = 1      |
| 96.61   | User data logger status word       | <i>PB</i>         | 0000h...FFFFh         | -    | 1 = 1      |
| 96.63   | User data logger trigger           | <i>Binary src</i> | -                     | -    | -          |
| 96.64   | User data logger start             | <i>Binary src</i> | -                     | -    | -          |
| 96.65   | Factory data logger time level     | <i>List</i>       | -                     | -    | 1 = 1      |
| 96.70   | Disable adaptive program           | <i>List</i>       | 0...1                 | -    | 1 = 1      |
| <i>(Parameters 96.100...96.102 only visible when enabled by parameter 96.02)</i>        |                                    |                   |                       |      |            |
| 96.100  | Change user pass code              | <i>Data</i>       | 10000000...99999999   | -    | 1 = 1      |
| 96.101  | Confirm user pass code             | <i>Data</i>       | 10000000...99999999   | -    | 1 = 1      |
| 96.102  | User lock functionality            | <i>PB</i>         | 0000h...FFFFh         | -    | 1 = 1      |
| <i>(Parameter 96.108 only visible when IGBT supply unit control activated by 95.20)</i> |                                    |                   |                       |      |            |
| 96.108  | LSU control board boot             | <i>Real</i>       | 0...1                 | -    | 1 = 1      |
| <b>97 Motor control</b>   |                                    |                   |                       |      |            |
| 97.01   | Switching frequency reference      | <i>Real</i>       | 0.000 ... 24.000      | kHz  | 1000 = 1%  |
| 97.02   | Minimum switching frequency        | <i>Real</i>       | 0.000 ... 24.000      | kHz  | 1000 = 1%  |
| 97.03   | Slip gain                          | <i>Real</i>       | 0...200               | %    | 1 = 1%     |
| 97.04   | Voltage reserve                    | <i>Real</i>       | -4...50               | %    | 1 = 1%     |
| 97.05   | Flux braking                       | <i>List</i>       | 0...2                 | -    | 1 = 1      |
| 97.06   | Flux reference select              | <i>Binary src</i> | -                     | -    | 1 = 1      |
| 97.07   | User flux reference                | <i>Real</i>       | 0.00 ... 200.00       | %    | 100 = 1%   |
| 97.08   | Optimizer minimum torque           | <i>Real</i>       | 0.0 ... 1600.0        | %    | 10 = 1%    |
| 97.09   | Switching freq mode                | <i>List</i>       | 0...3                 | -    | 1 = 1      |
| 97.10   | Signal injection                   | <i>List</i>       | 0...4                 | -    | 1 = 1      |
| 97.11   | TR tuning                          | <i>Real</i>       | 25...400              | %    | 1 = 1%     |
| 97.12   | IR comp step-up frequency          | <i>Real</i>       | 0.0 ... 50.0          | Hz   | 10 = 1 Hz  |
| 97.13   | IR compensation                    | <i>Real</i>       | 0.00 ... 50.00        | %    | 100 = 1%   |
| 97.15   | Motor model temperature adaptation | <i>List</i>       | 0...3                 | -    | 1 = 1      |
| 97.18   | Hexagonal field weakening          | <i>List</i>       | 0...1                 | -    | 1 = 1      |
| 97.19   | Hexagonal field weakening point    | <i>Real</i>       | 0.0 ... 500.0         | %    | 10 = 1%    |
| 97.32   | Motor torque unfiltered            | <i>Real</i>       | -1600.0 ... 1600.0    | %    | 10 = 1%    |
| 97.33   | Speed estimate filter time         | <i>Real</i>       | 0.00 ... 100.00       | ms   | 100 = 1 ms |

| No.                             | Name                       | Type        | Range   | Unit               | FbEq32          |
|---------------------------------|----------------------------|-------------|---|--------------------|-----------------|
| <b>98 User motor parameters</b> |                            |             |   |                    |                 |
| 98.01                           | User motor model mode      | <i>List</i> | 0...3   | -                  | 1 = 1           |
| 98.02                           | Rs user                    | <i>Real</i> | 0.0000 ... 0.50000                              | p.u.               | 100000 = 1 p.u. |
| 98.03                           | Rr user                    | <i>Real</i> | 0.0000 ... 0.50000                              | p.u.               | 100000 = 1 p.u. |
| 98.04                           | Lm user                    | <i>Real</i> | 0.00000 ... 10.00000                            | p.u.               | 100000 = 1 p.u. |
| 98.05                           | SigmaL user                | <i>Real</i> | 0.00000 ... 1.00000                             | p.u.               | 100000 = 1 p.u. |
| 98.06                           | Ld user                    | <i>Real</i> | 0.00000 ... 10.00000                            | p.u.               | 100000 = 1 p.u. |
| 98.07                           | Lq user                    | <i>Real</i> | 0.00000 ... 10.00000                            | p.u.               | 100000 = 1 p.u. |
| 98.08                           | PM flux user               | <i>Real</i> | 0.00000 ... 2.00000                             | p.u.               | 100000 = 1 p.u. |
| 98.09                           | Rs user SI                 | <i>Real</i> | 0.00000 ... 100.00000                           | ohm                | 100000 = 1 p.u. |
| 98.10                           | Rr user SI                 | <i>Real</i> | 0.00000 ... 100.00000                           | ohm                | 100000 = 1 p.u. |
| 98.11                           | Lm user SI                 | <i>Real</i> | 0.00 ... 100000.00                              | mH                 | 100 = 1 mH      |
| 98.12                           | SigmaL user SI             | <i>Real</i> | 0.00 ... 100000.00                              | mH                 | 100 = 1 mH      |
| 98.13                           | Ld user SI                 | <i>Real</i> | 0.00 ... 100000.00                              | mH                 | 100 = 1 mH      |
| 98.14                           | Lq user SI                 | <i>Real</i> | 0.00 ... 100000.00                              | mH                 | 100 = 1 mH      |
| 98.15                           | Position offset user       | <i>Real</i> | 0...360   | degrees electrical | 1 = 1 deg       |
| <b>99 Motor data</b>            |                            |             |   |                    |                 |
| 99.03                           | Motor type                 | <i>List</i> | 0...2   | -                  | 1 = 1           |
| 99.04                           | Motor control mode         | <i>List</i> | 0...1   | -                  | 1 = 1           |
| 99.06                           | Motor nominal current      | <i>Real</i> | 0.0 ... 6400.0                                  | A                  | 10 = 1 A        |
| 99.07                           | Motor nominal voltage      | <i>Real</i> | 0.0 ... 800.0                                   | V                  | 10 = 1 V        |
| 99.08                           | Motor nominal frequency    | <i>Real</i> | 0.00 ... 1000.00                                | Hz                 | 10 = 1 Hz       |
| 99.09                           | Motor nominal speed        | <i>Real</i> | 0 ... 30000                                     | rpm                | 1 = 1 rpm       |
| 99.10                           | Motor nominal power        | <i>Real</i> | 0.00 ... 10000.00 kW or<br>0.00 ... 13404.83 hp | kW or hp           | 100 = 1 unit    |
| 99.11                           | Motor nominal cos $\Phi$   | <i>Real</i> | 0.00 ... 1.00                                   | -                  | 100 = 1         |
| 99.12                           | Motor nominal torque       | <i>Real</i> | 0.000 ... 4000000.000                           | N·m or lb·ft       | 1000 = 1 unit   |
| 99.13                           | ID run requested           | <i>List</i> | 0...7   | -                  | 1 = 1           |
| 99.14                           | Last ID run performed      | <i>List</i> | 0...7   | -                  | 1 = 1           |
| 99.15                           | Motor polepairs calculated | <i>Real</i> | 0...1000  | -                  | 1 = 1           |
| 99.16                           | Motor phase order          | <i>List</i> | 0...1   | -                  | 1 = 1           |
| 99.18                           | Sine filter inductance     | <i>Real</i> | 0.000 ... 100000.000                            | mH                 | 1000 = 1 mH     |
| 99.19                           | Sine filter capacitance    | <i>Real</i> | 0.00 ... 100000.00                              | $\mu$ F            | 100 = 1 $\mu$ F |

486 *Additional parameter data*

| No.  | Name | Type | Range | Unit | FbEq32 |
|--|------|------|-------|------|--------|
| <b>200 Safety</b>  |      |      |       |      |        |
| This group contains parameters related to the optional FSO-xx safety functions module. For details on the parameters in this group, refer to the documentation of the FSO-xx module. |      |      |       |      |        |



# Fault tracing

---

## What this chapter contains

The chapter lists the warning and fault messages including possible causes and corrective actions. The causes of most warnings and faults can be identified and corrected using the information in this chapter. If not, an ABB service representative should be contacted.

Warnings and faults are listed below in separate tables. Each table is sorted by warning/fault code.

## Safety



**WARNING!** Only qualified electricians are allowed to service the drive. Read the *Safety instructions* on the first pages of the Hardware manual before working on the drive.

---

## Indications

### ■ Warnings and faults

Warnings and faults indicate an abnormal drive status. The codes and names of active warnings/faults are displayed on the control panel of the drive as well as the Drive composer PC tool. Only the codes of warnings/faults are available over fieldbus.

Warnings do not need to be reset; they stop showing when the cause of the warning ceases. Warnings do not latch and the drive will continue to operate the motor.

Faults do latch inside the drive and cause the drive to trip, and the motor stops. After the cause of a fault has been removed, the fault can be reset from a selectable

---

source (see parameter [31.11 Fault reset selection](#)) such as the control panel, Drive composer PC tool, the digital inputs of the drive, or fieldbus. After the fault is reset, the drive can be restarted. Note that some faults require a reboot of the control unit either by switching the power off and on, or using parameter [96.08 Control board boot](#) – this is mentioned in the fault listing wherever appropriate.

Warning and fault indications can be directed to a relay output or a digital input/output by selecting [Warning](#), [Fault](#) or [Fault \(-1\)](#) in the source selection parameter. See sections

- [Programmable digital inputs and outputs](#) (page 28)
- [Programmable relay outputs](#) (page 29), and
- [Programmable I/O extensions](#) (page 29).

### ■ Pure events

In addition to warnings and faults, there are pure events that are only recorded in the event logs of the drive. The codes of these events are included in the [Warning messages](#) table.

### ■ Editable messages

For some warnings and faults, the message text can be edited and instructions and contact information added. To edit these messages, choose **Menu - Settings - Edit texts** on the control panel.

## Warning/fault history and analysis

### ■ Event logs

The drive has two event logs. One log contains faults and fault resets; the other contains warnings, pure events, and clearing entries. Each log contains the 64 most recent events with a time stamp and other information.

The logs can be accessed separately from the main Menu on the control panel. The logs are displayed as a single list when viewed using the Drive composer PC tool.

### Auxiliary codes

Some events generate an auxiliary code that often helps in pinpointing the problem. The auxiliary code is displayed on the control panel together with the message. It is also stored in the event log details. In the Drive composer PC tool, the auxiliary code (if any) is shown in the event listing.

### Factory data logger

The drive has a data logger that samples preselected drive values at 500-microsecond (default; see parameter [96.65 Factory data logger time level](#)) intervals. By default, approximately 700 samples recorded immediately before and after a fault

---



are saved to the memory unit of the drive. The fault data of the last five faults is accessible in the event log when viewed in the Drive composer pro PC tool. (The fault data is not accessible through the control panel.)

The values that are recorded in the factory data log are [01.07 Motor current](#), [01.10 Motor torque](#), [01.11 DC voltage](#), [01.24 Flux actual %](#), [06.01 Main control word](#), [06.11 Main status word](#), [24.01 Used speed reference](#), [30.01 Limit word 1](#), [30.02 Torque limit status](#) and [90.01 Motor speed for control](#). The selection of parameters cannot be changed by the user.

## ■ Other data loggers

### User data logger

A custom data logger can be configured using the Drive composer pro PC tool. This functionality enables the free selection of up to eight drive parameters to be sampled at selectable intervals. The triggering conditions and the length of the monitoring period can also be defined by the user within the limit of approximately 8000 samples. In addition to the PC tool, the status of the logger is shown by drive parameter [96.61 User data logger status word](#). The triggering sources can be selected by parameters [96.63 User data logger trigger](#) and [96.64 User data logger start](#)). The configuration, status and collected data is saved to the memory unit for later analysis.

### PSL2 data logger

The BCU control unit used with certain drive types (especially those with parallel-connected inverter modules) contains a data logger that collects data from the inverter modules to help fault tracing and analysis. The data is saved onto the SD memory card attached to the BCU, and can be analyzed by ABB service personnel.

## ■ Parameters that contain warning/fault information

The drive is able to store a list of the active faults actually causing the drive to trip at the present time. The faults are displayed in parameter group [04 Warnings and faults](#) (page [120](#)). The parameter group also displays a list of faults and warnings that have previously occurred.

### Event word (parameters [04.40...04.72](#))

Parameter [04.40 Event word 1](#) can be configured by the user to indicate the status of 16 selectable events (ie. faults, warnings or pure events). It is possible to specify an auxiliary code for each event to filter out other auxiliary codes.

---

## **QR Code generation for mobile service application**

A QR Code (or a series of QR Codes) can be generated by the drive for display on the control panel. The QR Code contains drive identification data, information on the latest events, and values of status and counter parameters. The code can be read with a mobile device containing the ABB service application, which then sends the data to ABB for analysis. For more information on the application, contact your local ABB service representative.

The QR Code can be generated by choosing **Menu - Assistants - QR code** on the control panel.

---

## Warning messages

**Note:** The list also contains events that only appear in the Event log.

| Code (hex) | Warning  | Cause  | What to do   |
|------------|--|--|--|
| A2A1       | Current calibration  | Current offset and gain measurement calibration will occur at next start.  | Informative warning. (See parameter <a href="#">99.13 ID run requested</a> .)  |
| A2B3       | Earth leakage<br>Programmable fault: <a href="#">31.20 Earth fault</a> | Drive has detected load unbalance typically due to earth fault in motor or motor cable.  | Check there are no power factor correction capacitors or surge absorbers in motor cable.<br>Check for an earth fault in motor or motor cables by measuring the insulation resistances of motor and motor cable.<br>Try running the motor in scalar control mode if allowed. (See parameter <a href="#">99.04 Motor control mode</a> .)<br>If no earth fault can be detected, contact your local ABB representative.  |
| A2B4       | Short circuit  | Short-circuit in motor cable(s) or motor.  | Check motor and motor cable for cabling errors.<br>Check there are no power factor correction capacitors or surge absorbers in motor cable.  |
| A2BA       | IGBT overload  | Excessive IGBT junction to case temperature. This warning protects the IGBT(s) and can be activated by a short circuit in the motor cable. | Check motor cable.<br>Check ambient conditions.<br>Check air flow and fan operation.<br>Check heatsink fins for dust pick-up.<br>Check motor power against drive power.  |
| A3A1       | DC link overvoltage  | Intermediate circuit DC voltage too high (when the drive is stopped).  | Check the supply voltage setting (parameter <a href="#">95.01 Supply voltage</a> ). Note that the wrong setting of the parameter may cause the motor to rush uncontrollably, or may overload the brake chopper or resistor.<br>Check the supply voltage.<br>With A3A1 or A3A2 on parallel-connected inverter modules, the auxiliary code indicates the affected module. The format of the code is 000X XX00, where "XXX" specifies the channel on the BCU control unit.<br>If the problem persists, contact your local ABB representative. |
| A3A2       | DC link undervoltage   | Intermediate circuit DC voltage too low (when the drive is stopped).   |  |
| A3AA       | DC not charged   | The voltage of the intermediate DC circuit has not yet risen to operating level.   |  |
| A480       | Motor cable overload   | Calculated motor cable temperature has exceeded warning limit.   | Check the settings of parameters <a href="#">35.61</a> and <a href="#">35.62</a> .<br>Check the dimensioning of the motor cable in regard to required load.  |

## 492 Fault tracing

| Code (hex) | Warning   | Cause   | What to do   |
|------------|---|---|--|
| A490       | Incorrect temperature sensor setup                | Problem with motor temperature measurement.                                     | Check the auxiliary code (format 0XYY ZZZZ).<br>"X" identifies the affected temperature monitoring function (0 = parameter <a href="#">35.11</a> , 1 = parameter <a href="#">35.21</a> ).<br>"YY" indicates the selected temperature source, ie. the setting of the selection parameter in hexadecimal.<br>"ZZZZ" indicates the problem (see actions for each code below). |
|            | 0001  | Sensor type mismatch  | Check parameters <a href="#">35.11/35.21</a> against <a href="#">91.21/91.24</a> .   |
|            | 0002  | Temperature under limit   | Check parameters <a href="#">35.11...35.14/35.21...35.24</a> (and <a href="#">91.21/91.24</a> if sensor is connected to an encoder interface).<br>Check the sensor and its wiring.   |
|            | 0003  | Short circuit   |  |
|            | 0004  | Open circuit  |  |
| A491       | External temperature 1<br>(Editable message text) | Measured temperature 1 has exceeded warning limit.                              | Check the value of parameter <a href="#">35.02 Measured temperature 1</a> .<br>Check the cooling of the motor (or other equipment whose temperature is being measured).<br>Check the value of <a href="#">35.13 Temperature 1 warning limit</a> .  |
| A492       | External temperature 2<br>(Editable message text) | Measured temperature 2 has exceeded warning limit.                              | Check the value of parameter <a href="#">35.03 Measured temperature 2</a> .<br>Check the cooling of the motor (or other equipment whose temperature is being measured).<br>Check the value of <a href="#">35.23 Temperature 2 warning limit</a> .  |
| A497       | Motor temperature 1<br>(Editable message text)    | The thermistor protection module installed in slot 1 indicates overtemperature. | Check the cooling of the motor.<br>Check the motor load and drive ratings.<br>Check the wiring of the temperature sensor. Repair wiring if faulty.<br>Measure the resistance of the sensor.<br>Replace sensor if faulty.   |
| A498       | Motor temperature 2<br>(Editable message text)    | The thermistor protection module installed in slot 2 indicates overtemperature. |  |
| A499       | Motor temperature 3<br>(Editable message text)    | The thermistor protection module installed in slot 3 indicates overtemperature. |  |
| A4A0       | Control board temperature                         | Control unit temperature is excessive.  | Check the auxiliary code. See actions for each code below.   |
|            | (none)  | Temperature above warning limit   | Check ambient conditions.<br>Check air flow and fan operation.<br>Check heatsink fins for dust pick-up.  |
|            | 1   | Thermistor broken   | Contact an ABB service representative for control unit replacement.  |

| Code (hex) | Warning                       | Cause   | What to do   |
|------------|-------------------------------|---|--|
| A4A9       | Cooling                       | Drive module temperature is excessive.  | <p>Check ambient temperature. If it exceeds 40 °C (104 °F), ensure that load current does not exceed derated load capacity of drive. See appropriate <i>Hardware manual</i>.</p> <p>Check drive module cooling air flow and fan operation.</p> <p>Check inside of cabinet and heatsink of drive module for dust pick-up. Clean whenever necessary.</p>   |
| A4B0       | Excess temperature            | Power unit temperature is excessive.  | <p>Check ambient conditions.</p> <p>Check air flow and fan operation.</p> <p>Check heatsink fins for dust pick-up.</p> <p>Check motor power against drive power.</p> <p>Check the auxiliary code (format XXXY YYZZ). "Y YY" specifies through which BCU control unit channel the fault was received. "ZZ" specifies the location (<b>1</b>: U-phase, <b>2</b>: V-phase, <b>3</b>: W-phase, <b>4</b>: INT board, <b>5</b>: Brake chopper, <b>6</b>: Air inlet (sensor connected to INT board X10), <b>7</b>: PCB compartment fan or power supply board, <b>8</b>: du/dt filter or temperature switch (XT) (sensor connected to INT board X7), <b>9</b>: Sensor connected to INT board X6, <b>OFA</b>: Ambient temperature).</p> |
| A4B1       | Excess temperature difference | High temperature difference between the IGBTs of different phases.              | <p>Check the motor cabling.</p> <p>Check cooling of drive module(s).</p> <p>Check the auxiliary code (format XXXY YYZZ). "XXX" indicates the source of difference (<b>0</b>: Single module, difference between phase IGBTs, <b>1</b>: parallel-connected modules, minimum-maximum difference between all IGBTs of all modules). With parallel-connected modules, "Y YY" specifies through which BCU control unit channel the fault was received. "ZZ" specifies the phase (<b>0</b>: single module, <b>1</b>: U-phase [parallel connection], <b>2</b>: W-phase [parallel connection], <b>3</b>: W-phase [parallel connection]).</p>  |
| A4B2       | PCB space cooling             | Temperature difference between ambient and drive module PCB space is excessive. | <p>Check the cooling fan inside the PCB space.</p> <p>With parallel-connected modules, check the auxiliary code (format XXXY YYZZ). "Y YY" specifies through which BCU control unit channel the fault was received.</p>  |
| A4F6       | IGBT temperature              | Drive IGBT temperature is excessive.  | <p>Check ambient conditions.</p> <p>Check air flow and fan operation.</p> <p>Check heatsink fins for dust pick-up.</p> <p>Check motor power against drive power.</p>   |

| Code (hex) | Warning   | Cause  | What to do   |
|------------|---|--|--|
| A580       | PU communication  | Communication errors detected between the drive control unit and the power unit.                         | Check the connections between the drive control unit and the power unit.<br>Check the auxiliary code (format XXXY YYZZ). With parallel-connected modules, "Y YY" specifies the affected BCU control unit channel ( <b>0</b> : broadcast). "ZZ" specifies the error source ( <b>8</b> : Transmission errors in PSL link [see "XXX"], <b>9</b> : Transmitter FIFO warning limit hit). "XXX" specifies the transmission error direction and detailed warning code ( <b>0</b> : Rx/communication error, <b>1</b> : Tx/Reed-Solomon symbol error, <b>2</b> : Tx/no synchronization error, <b>3</b> : Tx/Reed-Solomon decoder failures, <b>4</b> : Tx/Manchester coding errors). |
| A581       | Fan   | Cooling fan feedback missing.  | Check the setting of parameter <a href="#">95.20 HW options word 1</a> , bit 14.<br>Check the auxiliary code to identify the fan. Code <b>0</b> denotes main fan 1. Other codes (format XYZ): "X" specifies state code ( <b>1</b> : ID run, <b>2</b> : normal). "Y" specifies the index of the inverter unit connected to BCU ( <b>0...n</b> , always <b>0</b> for ZCU control units). "Z" specifies the index of the fan ( <b>1</b> : Main fan 1, <b>2</b> : Main fan 2, <b>3</b> : Main fan 3).<br>Check fan operation and connection.<br>Replace fan if faulty.   |
| A582       | Auxiliary fan missing   | An auxiliary cooling fan (connected to the fan connectors on the control unit) is stuck or disconnected. | The auxiliary code identifies the fan ( <b>1</b> : Auxiliary fan 1, <b>2</b> : Auxiliary fan 2).<br>Check auxiliary fan(s) and connection(s).<br>Replace faulty fan.<br>Make sure the front cover of the drive module is in place and tightened. If the commissioning of the drive requires that the cover is off, this warning will be generated even if the corresponding fault is defeated. See fault <a href="#">5081 Auxiliary fan broken</a> (page <a href="#">512</a> ).  |
| A5A0       | Safe torque off<br>Programmable warning:<br><a href="#">31.22 STO indication run/stop</a> | Safe torque off function is active, i.e. safety circuit signal(s) connected to connector XSTO is lost.   | Check safety circuit connections. For more information, see appropriate drive hardware manual and description of parameter <a href="#">31.22 STO indication run/stop</a> (page <a href="#">267</a> ).  |
| A5EA       | Measurement circuit temperature   | Problem with internal temperature measurement of the drive.  | Check the auxiliary code (format XXXY YYZZ). "Y YY" specifies through which BCU control unit channel the fault was received ("0 00" with a ZCU control unit). "ZZ" specifies the location ( <b>1</b> : U-phase IGBT, <b>2</b> : V-phase IGBT, <b>3</b> : W-phase IGBT, <b>4</b> : Power unit INT board, <b>5</b> : Brake chopper, <b>6</b> : Air inlet, <b>7</b> : Power supply board, <b>8</b> : du/dt filter, <b>Fa</b> : Air in temp).  |
| A5EB       | PU board powerfail  | Power unit power supply failure.   | Contact your local ABB representative.   |

| Code (hex) | Warning   | Cause  | What to do   |
|------------|---|--|--|
| A5EC       | PU communication internal   | Communication errors detected between the drive control unit and the power unit.   | Check the connections between the drive control unit and the power unit.   |
| A5ED       | Measurement circuit ADC   | Problem with measurement circuit of power unit (analog to digital converter)   | Contact your local ABB representative.   |
| A5EE       | Measurement circuit DFF   | Problem with current or voltage measurement of power unit  | Contact your local ABB representative.   |
| A5EF       | PU state feedback   | State feedback from output phases does not match control signals.  | Contact your local ABB representative.   |
| A5F0       | Charging feedback   | Charging in progress   | Informative warning. Wait until charging finishes before starting the inverter unit.   |
| A5F3       | Switching frequency below requested   | Adequate motor control at requested output frequency cannot be reached because of limited switching frequency (eg. by parameter <a href="#">95.15</a> ). | Informative warning.   |
| A5F4       | Control unit battery  | The battery of the control unit is low.  | Replace control unit battery. This warning can be suppressed using parameter <a href="#">31.40</a> .   |
| A682       | Flash erase speed exceeded  | The flash memory (in the memory unit) has been erased too frequently, compromising the lifetime of the memory.   | Avoid forcing unnecessary parameter saves by parameter <a href="#">96.07</a> or cyclic parameter writes (such as user logger triggering through parameters). Check the auxiliary code (format YYYY YZZZ). "X" specifies the source of warning (1: generic flash erase supervision). "ZZZ" specifies the flash subsector number that generated the warning. |
| A683       | Data saving to power unit   | An error in saving data to the power unit.   | Check the auxiliary code. See actions for each code below.   |
|            |   | 0 An error is preventing saving from initializing.   | Cycle the power to the drive. If the control unit is externally powered, also reboot the control unit (using parameter <a href="#">96.08 Control board boot</a> ) or by cycling its power. If the problem persists, contact your local ABB representative.   |
|            |   | 1  |  |
|            |   | 2 Write error.   |  |
| A684       | SD card   | Error related to SD card used to store data (BCU control unit only).   | Check the auxiliary code. See actions for each code below.   |
|            |   | 1 No SD card   | Insert a compatible, writable SD card into the SD CARD slot of the BCU control unit.   |
|            |   | 2 SD card write-protected  |  |
|            |   | 3 SD card unreadable   |  |
| A686       | Checksum mismatch Programmable warning: <a href="#">96.54 Checksum action</a> | The calculated parameter checksum does not match any enabled reference checksum.   | Check that all necessary approved (reference) checksums ( <a href="#">96.56...96.59</a> ) are enabled in <a href="#">96.55 Checksum control word</a> .<br>Check the parameter configuration. Using <a href="#">96.55 Checksum control word</a> , enable a checksum parameter and copy the actual checksum into that parameter.                             |

| Code (hex) | Warning                      | Cause   | What to do  |
|------------|------------------------------|---|---|
| A687       | Checksum configuration       | An action has been defined for a parameter checksum mismatch but the feature has not been configured.                   | Contact your local ABB representative for configuring the feature, or disable the feature in <a href="#">96.54 Checksum action</a> .  |
| A688       | Parameter map configuration  | Too much data in parameter mapping table created in Drive customizer.   | See the <i>Drive customizer PC tool user's manual</i> (3AUA0000104167 [English]).   |
| A689       | Mapped parameter value cut   | Parameter value saturated eg. by the scaling specified in parameter mapping table (created in Drive customizer).        | Check parameter scaling and format in parameter mapping table. See the <i>Drive customizer PC tool user's manual</i> (3AUA0000104167 [English]).  |
| A6A4       | Motor nominal value          | The motor parameters are set incorrectly.<br>The drive is not dimensioned correctly.                                    | Check the auxiliary code. See actions for each code below.  |
|            |                              | 1 Slip frequency is too small   | Check the settings of the motor configuration parameters in groups 98 and 99.<br>Check that the drive is sized correctly for the motor.   |
|            |                              | 2 Synchronous and nominal speeds differ too much  |   |
|            |                              | 3 Nominal speed is higher than synchronous speed with 1 pole pair   |   |
|            |                              | 4 Nominal current is outside limits   |   |
|            |                              | 5 Nominal voltage is outside limits   |   |
|            |                              | 6 Nominal power is higher than apparent power   |   |
|            |                              | 7 Nominal power not consistent with nominal speed and torque  |   |
| A6A5       | No motor data                | Parameters in group 99 have not been set.   | Check that all the required parameters in group 99 have been set.<br><b>Note:</b> It is normal for this warning to appear during the start-up and continue until the motor data is entered.                       |
| A6A6       | Supply voltage unselected    | The supply voltage has not been defined.  | Set supply voltage in parameter <a href="#">95.01 Supply voltage</a> .  |
| A6B0       | User lock is open            | The user lock is open, ie. user lock configuration parameters <a href="#">96.100...96.102</a> are visible.              | Close the user lock by entering an invalid pass code in parameter <a href="#">96.02 Pass code</a> . See section <a href="#">User lock</a> (page <a href="#">91</a> ).   |
| A6B1       | User pass code not confirmed | A new user pass code has been entered in parameter <a href="#">96.100</a> but not confirmed in <a href="#">96.101</a> . | Confirm the new pass code by entering the same code in <a href="#">96.101</a> . To cancel, close the user lock without confirming the new code. See section <a href="#">User lock</a> (page <a href="#">91</a> ). |
| A6D1       | FBA A parameter conflict     | The drive does not have a functionality requested by a PLC, or requested functionality has not been activated.          | Check PLC programming.<br>Check settings of parameter groups <a href="#">50 Fieldbus adapter (FBA)</a> and <a href="#">51 FBA A settings</a> .  |



| Code (hex) | Warning   | Cause  | What to do   |
|------------|---|--|--|
| A6D2       | FBA B parameter conflict  | The drive does not have a functionality requested by a PLC, or requested functionality has not been activated. | Check PLC programming.<br>Check settings of parameter groups <a href="#">50 Fieldbus adapter (FBA)</a> and <a href="#">54 FBA B settings</a> .   |
| A6DA       | Reference source parametrization  | A reference source is simultaneously connected to multiple parameters with different units.                    | Check the reference source selection parameters.<br>Check the auxiliary code (format XXYY 00ZZ). "XX" and "YY" specify the two sets of parameters where the source was connected to ( <b>01</b> = speed reference chain [ <a href="#">22.11</a> , <a href="#">22.12</a> , <a href="#">22.15</a> , <a href="#">22.17</a> ], <b>02</b> = frequency reference chain [ <a href="#">28.11</a> , <a href="#">28.12</a> ], <b>03</b> = torque reference chain [ <a href="#">26.11</a> , <a href="#">26.12</a> , <a href="#">26.16</a> ], <b>04</b> = other torque-related parameters [ <a href="#">26.25</a> , <a href="#">30.21</a> , <a href="#">30.22</a> , <a href="#">44.09</a> ], <b>05</b> = process PID control parameters [ <a href="#">40.16</a> , <a href="#">40.17</a> , <a href="#">40.50</a> , <a href="#">41.16</a> , <a href="#">41.17</a> , <a href="#">41.50</a> ]). "ZZ" indicates the conflicting reference source ( <b>01...0E</b> = index in parameter group 3, <b>33</b> = process PID control, <b>3D</b> = motor potentiometer, <b>65</b> = AI1, <b>66</b> = AI2, <b>6F</b> = frequency input). |
| A6E5       | AI parametrization  | The current/voltage hardware setting of an analog input does not correspond to parameter settings.             | Check the auxiliary code. The code identifies the analog input whose settings are in conflict.<br>Adjust either the hardware setting (on the drive control unit) or parameter <a href="#">12.15/12.25</a> .<br><b>Note:</b> Control board reboot (either by cycling the power or through parameter <a href="#">96.08 Control board boot</a> ) is required to validate any changes in the hardware settings.  |
| A6E6       | ULC configuration   | User load curve configuration error.   | Check the auxiliary code (format XXXX ZZZZ). "ZZZZ" indicates the problem (see actions for each code below).   |
|            | 0000  | Speed points inconsistent.   | Check that each speed point (parameters <a href="#">37.11...37.15</a> ) has a higher value than the previous point.  |
|            | 0001  | Frequency points inconsistent.   | Check that each frequency point ( <a href="#">37.16...37.20</a> ) has a higher value than the previous point.  |
|            | 0002  | Underload point above overload point.  | Check that each overload point ( <a href="#">37.31...37.35</a> ) has a higher value than the corresponding underload point ( <a href="#">37.21...37.25</a> ).  |
|            | 0003  | Overload point below underload point.  |  |
| A780       | Motor stall<br>Programmable warning:<br><a href="#">31.24 Stall function</a>        | Motor is operating in stall region because of e.g. excessive load or insufficient motor power.                 | Check motor load and drive ratings.<br>Check fault function parameters.  |
| A781       | Motor fan<br>Programmable warning:<br><a href="#">35.106 DOL starter event type</a> | No feedback received from external fan.  | Check external fan (or other equipment controlled) by the logic.<br>Check settings of parameters <a href="#">35.100...35.106</a> .   |

| Code (hex) | Warning                      | Cause   | What to do   |
|------------|------------------------------|---|--|
| A782       | FEN temperature              | Error in temperature measurement when temperature sensor (KTY or PTC) connected to encoder interface FEN-xx is used.            | Check that parameter <a href="#">35.11 Temperature 1 source</a> / <a href="#">35.21 Temperature 2 source</a> setting corresponds to actual encoder interface installation.<br>Check the settings of parameters <a href="#">91.21</a> and <a href="#">91.24</a> . Check that the corresponding module is activated in parameters <a href="#">91.11...91.14</a> . Use parameter <a href="#">91.10 Encoder parameter refresh</a> to validate any changes in the settings. |
|            |                              | Error in temperature measurement when KTY sensor connected to encoder interface FEN-01 is used.                                 | FEN-01 does not support temperature measurement with KTY sensor. Use PTC sensor or other encoder interface module.   |
| A791       | Brake resistor               | Brake resistor broken or not connected.   | Check that a brake resistor has been connected.<br>Check the condition of the brake resistor.  |
| A793       | BR excess temperature        | Brake resistor temperature has exceeded warning limit defined by parameter <a href="#">43.12 Brake resistor warning limit</a> . | Stop drive. Let resistor cool down.<br>Check resistor overload protection function settings (parameter group <a href="#">43 Brake chopper</a> ).<br>Check warning limit setting, parameter <a href="#">43.12 Brake resistor warning limit</a> .<br>Check that the resistor has been dimensioned correctly.<br>Check that braking cycle meets allowed limits.   |
| A794       | BR data                      | Brake resistor data has not been given.   | One or more of the resistor data settings (parameters <a href="#">43.08...43.10</a> ) is incorrect. The parameter is specified by the auxiliary code.  |
|            |                              | 0000 0001   | Resistance value too low.<br>Check value of <a href="#">43.10</a> .  |
|            |                              | 0000 0002   | Thermal time constant not given.<br>Check value of <a href="#">43.08</a> .   |
|            |                              | 0000 0003   | Maximum continuous power not given.<br>Check value of <a href="#">43.09</a> .  |
| A797       | Speed feedback configuration | Speed feedback configuration has changed.   | Check the auxiliary code (format XXYY ZZZZ). "XX" specifies the number of the encoder interface module ( <b>01</b> : <a href="#">91.11/91.12</a> , <b>02</b> : <a href="#">91.13/91.14</a> ), "YY" specifies the encoder ( <b>01</b> : <a href="#">92 Encoder 1 configuration</a> , <b>02</b> : <a href="#">93 Encoder 2 configuration</a> ). "ZZZZ" indicates the problem (see actions for each code below).  |
|            |                              | 0001  | Adapter not found in specified slot.<br>Check module location ( <a href="#">91.12</a> or <a href="#">91.14</a> ).  |
|            |                              | 0002  | Detected type of interface module does not match parameter setting.<br>Check the module type ( <a href="#">91.11</a> or <a href="#">91.13</a> ) against status ( <a href="#">91.02</a> or <a href="#">91.03</a> ).   |
|            |                              | 0003  | Logic version too old.<br>Contact your local ABB representative.   |
|            |                              | 0004  | Software version too old.<br>Contact your local ABB representative.  |

| Code (hex) | Warning                  | Cause  | What to do   |
|------------|--------------------------|--|--|
|            | 0006                     | Encoder type incompatible with interface module type.  | Check module type (91.11 or 91.13) against encoder type (92.01 or 93.01).  |
|            | 0007                     | Adapter not configured.  | Check module location (91.12 or 91.14).  |
|            | 0008                     | Speed feedback configuration has changed.  | Use parameter 91.10 <i>Encoder parameter refresh</i> to validate any changes in the settings.  |
|            | 0009                     | No encoders configured to encoder module   | Configure the encoder in group 92 <i>Encoder 1 configuration</i> or 93 <i>Encoder 2 configuration</i> .  |
|            | 000A                     | Non-existing emulation input.  | Check input selection (91.31 or 91.41).  |
|            | 000B                     | Echo not supported by selected input (for example, resolver or absolute encoder).  | Check input selection (91.31 or 91.41), interface module type, and encoder type.   |
|            | 000C                     | Emulation in continuous mode not supported.  | Check input selection (91.31 or 91.41) and serial link mode (92.30 or 93.30) settings.   |
| A798       | Encoder option comm loss | Encoder feedback not used as actual feedback, or measured motor feedback lost (and parameter 90.45/90.55 is set to <i>Warning</i> ). | <p>Check that the encoder is selected as feedback source in parameter 90.41 or 90.51.</p> <p>Check that the encoder interface module is properly seated in its slot.</p> <p>Check that the encoder interface module or slot connectors are not damaged. To pinpoint the problem, try installing the module into a different slot.</p> <p>If the module is installed on an FEA-03 extension adapter, check the fiber optic connections.</p> <p>Check the auxiliary code (format XXXX YYYY). "YYYY" indicates the problem (see actions for each code below).</p> |
|            | 0001                     | Failed answer to encoder configuration message.  | Contact your local ABB representative.   |
|            | 0002                     | Failed answer to adapter watchdog disable message.   | Contact your local ABB representative.   |
|            | 0003                     | Failed answer to adapter watchdog enable message.  | Contact your local ABB representative.   |
|            | 0004                     | Failed answer to adapter configuration message.  | Contact your local ABB representative.   |
|            | 0005                     | Too many failed answers inline to speed and position messages.   | Contact your local ABB representative.   |
|            | 0006                     | DDCS driver failed.  | Contact your local ABB representative.   |
| A79B       | BC short circuit         | Short circuit in brake chopper IGBT  | <p>Replace brake chopper if external. Drives with internal choppers will need to be returned to ABB.</p> <p>Ensure brake resistor is connected and not damaged.</p>  |

| Code (hex) | Warning  | Cause   | What to do   |
|------------|--|---|--|
| A79C       | BC IGBT excess temperature   | Brake chopper IGBT temperature has exceeded internal warning limit.   | Let chopper cool down.<br>Check for excessive ambient temperature.<br>Check for cooling fan failure.<br>Check for obstructions in the air flow.<br>Check the dimensioning and cooling of the cabinet.<br>Check resistor overload protection function settings (parameters <a href="#">43.06...43.10</a> ).<br>Check minimum allowed resistor value for the chopper being used.<br>Check that braking cycle meets allowed limits.<br>Check that drive supply AC voltage is not excessive.   |
| A7A1       | Mechanical brake closing failed<br>Programmable warning: <a href="#">44.17 Brake fault function</a>      | Status of mechanical brake acknowledgement is not as expected during brake close.   | Check mechanical brake connection.<br>Check mechanical brake settings in parameter group <a href="#">44 Mechanical brake control</a> .<br>Check that acknowledgement signal matches actual status of brake.  |
| A7A2       | Mechanical brake opening failed<br>Programmable warning: <a href="#">44.17 Brake fault function</a>      | Status of mechanical brake acknowledgement is not as expected during brake open.  | Check mechanical brake connection.<br>Check mechanical brake settings in parameter group <a href="#">44 Mechanical brake control</a> .<br>Check that acknowledgement signal matches actual status of brake.  |
| A7A5       | Mechanical brake opening not allowed<br>Programmable warning: <a href="#">44.17 Brake fault function</a> | Open conditions of mechanical brake cannot be fulfilled (for example, brake has been prevented from opening by parameter <a href="#">44.11 Keep brake closed</a> ). | Check mechanical brake settings in parameter group <a href="#">44 Mechanical brake control</a> (especially <a href="#">44.11 Keep brake closed</a> ).<br>Check that acknowledgement signal (if used) matches actual status of brake.   |
| A7AA       | Extension AI parameterization  | The hardware current/voltage setting of an analog input (on an I/O extension module) does not correspond to parameter settings.                                     | Check the auxiliary code (format XX00 00YY). "XX" specifies the number of the I/O extension module ( <b>01</b> : parameter group <a href="#">14 I/O extension module 1</a> , <b>02</b> : <a href="#">15 I/O extension module 2</a> , <b>03</b> : <a href="#">16 I/O extension module 3</a> ). "YY" specifies the analog input on the module. For example, in case of I/O extension module 1, analog input AI1 (auxiliary code 0000 0101), the hardware current/voltage setting on the module is shown by parameter <a href="#">14.29</a> . The corresponding parameter setting is <a href="#">14.30</a> . Adjust either the hardware setting on the module or the parameter to solve the mismatch.<br><b>Note:</b> Control board reboot (either by cycling the power or through parameter <a href="#">96.08 Control board boot</a> ) is required to validate any changes in the hardware settings. |

| Code (hex) | Warning   | Cause  | What to do  |
|------------|---|--|---|
| A7AB       | Extension I/O configuration failure   | The I/O extension module types and locations specified by parameters do not match the detected configuration.            | Check the type and location settings of the modules (parameters <a href="#">14.01</a> , <a href="#">14.02</a> , <a href="#">15.01</a> , <a href="#">15.02</a> , <a href="#">16.01</a> and <a href="#">16.02</a> ).<br>Check that the modules are properly installed.<br>Check the auxiliary code. See <i>Drive application programming manual (IEC 61131-3)</i> (3AUA0000127808 [English]).                   |
| A7B0       | Motor speed feedback<br>Programmable warning:<br><a href="#">90.45 Motor feedback fault</a> | No motor speed feedback is received.   | Check the auxiliary code (format XXYY ZZZZ). "XX" specifies the number of the encoder interface module ( <b>01</b> : <a href="#">91.11/91.12</a> , <b>02</b> : <a href="#">91.13/91.14</a> ), "YY" specifies the encoder ( <b>01</b> : <a href="#">92 Encoder 1 configuration</a> , <b>02</b> : <a href="#">93 Encoder 2 configuration</a> ). "ZZZZ" indicates the problem (see actions for each code below). |
|            | 0001  | Motor gear definition invalid or outside limits.   | Check motor gear settings ( <a href="#">90.43</a> and <a href="#">90.44</a> ).  |
|            | 0002  | Encoder not configured.  | Check encoder settings ( <a href="#">92 Encoder 1 configuration</a> or <a href="#">93 Encoder 2 configuration</a> ).<br>Use parameter <a href="#">91.10 Encoder parameter refresh</a> to validate any changes in the settings.  |
|            | 0003  | Encoder stopped working.   | Check encoder status.   |
|            | 0004  | Encoder drift detected.  | Check for slippage between encoder and motor.   |
| A7B1       | Load speed feedback<br>Programmable warning:<br><a href="#">90.55 Load feedback fault</a>   | No load speed feedback is received.  | Check the auxiliary code (format XXYY ZZZZ). "XX" specifies the number of the encoder interface module ( <b>01</b> : <a href="#">91.11/91.12</a> , <b>02</b> : <a href="#">91.13/91.14</a> ), "YY" specifies the encoder ( <b>01</b> : <a href="#">92 Encoder 1 configuration</a> , <b>02</b> : <a href="#">93 Encoder 2 configuration</a> ). "ZZZZ" indicates the problem (see actions for each code below). |
|            | 0001  | Load gear definition invalid or outside limits.  | Check load gear settings ( <a href="#">90.53</a> and <a href="#">90.54</a> ).   |
|            | 0002  | Feed constant definition invalid or outside limits.  | Check feed constant settings ( <a href="#">90.63</a> and <a href="#">90.64</a> ).   |
|            | 0003  | Encoder stopped working.   | Check encoder status.   |
| A7C1       | FBA A communication<br>Programmable warning:<br><a href="#">50.02 FBA A comm loss func</a>  | Cyclical communication between drive and fieldbus adapter module A or between PLC and fieldbus adapter module A is lost. | Check status of fieldbus communication. See user documentation of fieldbus interface.<br>Check settings of parameter groups <a href="#">50 Fieldbus adapter (FBA)</a> , <a href="#">51 FBA A settings</a> , <a href="#">52 FBA A data in</a> and <a href="#">53 FBA A data out</a> .<br>Check cable connections.<br>Check if communication master is able to communicate.                                     |

## 502 Fault tracing

| Code (hex) | Warning  | Cause  | What to do  |
|------------|--|--|---|
| A7C2       | FBA B communication<br>Programmable warning:<br><a href="#">50.32 FBA B comm loss func</a>                     | Cyclical communication between drive and fieldbus adapter module B or between PLC and fieldbus adapter module B is lost. | Check status of fieldbus communication. See user documentation of fieldbus interface.<br>Check settings of parameter group <a href="#">50 Fieldbus adapter (FBA)</a> .<br>Check cable connections.<br>Check if communication master is able to communicate.   |
| A7CA       | DDCS controller comm loss<br>Programmable warning:<br><a href="#">60.59 DDCS controller comm loss function</a> | DDCS (fiber optic) communication between drive and external controller is lost.  | Check status of controller. See user documentation of controller.<br>Check settings of parameter group <a href="#">60 DDCS communication</a> .<br>Check cable connections. If necessary, replace cables.  |
| A7CB       | MF comm loss<br>Programmable warning:<br><a href="#">60.09 M/F comm loss function</a>                          | Master/follower communication is lost.   | Check the auxiliary code. The code indicates which node address (defined by parameter <a href="#">60.02</a> in each drive) on the master/follower link is affected.<br>Check settings of parameter group <a href="#">60 DDCS communication</a> .<br>On the FDCO module (if present), check that the DDCS link switch is not set to 0 (OFF).<br>Check cable connections. If necessary, replace cables.         |
| A7CE       | EFB comm loss<br>Programmable warning:<br><a href="#">58.14 Communication loss action</a>                      | Communication break in embedded fieldbus (EFB) communication.  | Check the status of the fieldbus master (online/offline/error etc.).<br>Check cable connections to the XD2D connector on the control unit.  |
| A7E1       | Encoder<br>Programmable warning:<br><a href="#">90.45 Motor feedback fault</a>                                 | Encoder error.   | Check the auxiliary code (format XXYY ZZZZ). "XX" specifies the number of the encoder interface module ( <b>01</b> : <a href="#">91.11/91.12</a> , <b>02</b> : <a href="#">91.13/91.14</a> ), "YY" specifies the encoder ( <b>01</b> : <a href="#">92 Encoder 1 configuration</a> , <b>02</b> : <a href="#">93 Encoder 2 configuration</a> ). "ZZZZ" indicates the problem (see actions for each code below). |
|            | 0001   | Cable fault  | Check the conductor order at both ends of the encoder cable.<br>Check the groundings of the encoder cable.<br>If the encoder was working previously, check the encoder, encoder cable and encoder interface module for damage.<br>See also parameter <a href="#">92.21 Encoder cable fault mode</a> .   |
|            | 0002   | No encoder signal  | Check the condition of the encoder.   |
|            | 0003   | Overspeed  | Contact your local ABB representative.  |
|            | 0004   | Overfrequency  | Contact your local ABB representative.  |
|            | 0005   | Resolver ID run failed   | Contact your local ABB representative.  |
|            | 0006   | Resolver overcurrent fault   | Contact your local ABB representative.  |
|            | 0007   | Speed scaling error  | Contact your local ABB representative.  |

| Code (hex) | Warning   | Cause   | What to do   |
|------------|---|---|--|
|            | 0008  | Absolute encoder communication error  | Contact your local ABB representative.   |
|            | 0009  | Absolute encoder initialization error   | Contact your local ABB representative.   |
|            | 000A  | Absolute SSI encoder configuration error  | Contact your local ABB representative.   |
|            | 000B  | Encoder reported an internal error  | See the documentation of the encoder.  |
|            | 000C  | Encoder reported a battery error  | See the documentation of the encoder.  |
|            | 000D  | Encoder reported overspeed or decreased resolution due to overspeed   | See the documentation of the encoder.  |
|            | 000E  | Encoder reported a position counter error   | See the documentation of the encoder.  |
|            | 000F  | Encoder reported an internal error  | See the documentation of the encoder.  |
| A7EE       | Control panel loss<br>Programmable warning:<br><a href="#">49.05 Communication loss action</a>  | Control panel (or PC tool) has stopped communicating.   | Check PC tool or control panel connection.<br>Check control panel connector.<br>Check mounting platform if being used.<br>Disconnect and reconnect the control panel.  |
| A880       | Motor bearing<br>Programmable warnings:<br><a href="#">33.14 On-time 1 warn message</a><br><a href="#">33.24 On-time 2 warn message</a><br><a href="#">33.55 Value counter 1 warn message</a><br><a href="#">33.65 Value counter 2 warn message</a> | Warning generated by an on-time timer or a value counter.   | Check the auxiliary code. Check the source of the warning corresponding to the code:<br>0: <a href="#">33.13 On-time 1 source</a><br>1: <a href="#">33.23 On-time 2 source</a><br>4: <a href="#">33.53 Value counter 1 source</a><br>5: <a href="#">33.63 Value counter 2 source</a> . |
| A881       | Output relay  | Warning generated by an edge counter.<br>Programmable warnings:<br><a href="#">33.35 Edge counter 1 warn message</a><br><a href="#">33.45 Edge counter 2 warn message</a> | Check the auxiliary code. Check the source of the warning corresponding to the code:<br>2: <a href="#">33.33 Edge counter 1 source</a><br>3: <a href="#">33.43 Edge counter 2 source</a> .   |
| A882       | Motor starts  |   |  |
| A883       | Power ups   |   |  |
| A884       | Main contactor  |   |  |
| A885       | DC charge   |   |  |
| A886       | On-time 1<br>(Editable message text)<br>Programmable warning:<br><a href="#">33.14 On-time 1 warn message</a>   | Warning generated by on-time timer 1.   | Check the source of the warning (parameter <a href="#">33.13 On-time 1 source</a> ).   |
| A887       | On-time 2<br>(Editable message text)<br>Programmable warning:<br><a href="#">33.24 On-time 2 warn message</a>   | Warning generated by on-time timer 2.   | Check the source of the warning (parameter <a href="#">33.23 On-time 2 source</a> ).   |
| A888       | Edge counter 1<br>(Editable message text)<br>Programmable warning:<br><a href="#">33.35 Edge counter 1 warn message</a>   | Warning generated by edge counter 1.  | Check the source of the warning (parameter <a href="#">33.33 Edge counter 1 source</a> ).  |



## 504 Fault tracing

| Code (hex) | Warning   | Cause  | What to do  |
|------------|---|--|---|
| A889       | Edge counter 2<br>(Editable message text)<br>Programmable warning:<br><a href="#">33.45 Edge counter 2 warn message</a>   | Warning generated by edge counter 2.   | Check the source of the warning (parameter <a href="#">33.43 Edge counter 2 source</a> ).   |
| A88A       | Value counter 1<br>(Editable message text)<br>Programmable warning:<br><a href="#">33.55 Value counter 1 warn message</a> | Warning generated by value counter 1.  | Check the source of the warning (parameter <a href="#">33.53 Value counter 1 source</a> ).  |
| A88B       | Value counter 2<br>(Editable message text)<br>Programmable warning:<br><a href="#">33.65 Value counter 2 warn message</a> | Warning generated by value counter 2.  | Check the source of the warning (parameter <a href="#">33.63 Value counter 2 source</a> ).  |
| A88C       | Device clean  | Warning generated by an on-time timer.<br>Programmable warnings:<br><a href="#">33.14 On-time 1 warn message</a><br><a href="#">33.24 On-time 2 warn message</a> | Check the auxiliary code. Check the source of the warning corresponding to the code:<br>0: <a href="#">33.13 On-time 1 source</a><br>1: <a href="#">33.23 On-time 2 source</a><br>10: <a href="#">05.04 Fan on-time counter</a> .   |
| A88D       | DC capacitor  |  |   |
| A88E       | Cabinet fan   |  |   |
| A88F       | Cooling fan   |  |   |
| A890       | Additional cooling  |  |   |
| A8A0       | AI supervision<br>Programmable warning:<br><a href="#">12.03 AI supervision function</a>                                  | An analog signal is outside the limits specified for the analog input.   | Check the auxiliary code (format XYY). “X” specifies the location of the input ( <b>0</b> : AI on control unit; <b>1</b> : I/O extension module 1, etc.), “YY” specifies the input and limit ( <b>01</b> : AI1 under minimum, <b>02</b> : AI1 over maximum, <b>03</b> : AI2 under minimum, <b>04</b> : AI2 over maximum). Check signal level at the analog input. Check the wiring connected to the input. Check the minimum and maximum limits of the input in parameter group <a href="#">12 Standard AI</a> , <a href="#">14 I/O extension module 1</a> , <a href="#">15 I/O extension module 2</a> or <a href="#">16 I/O extension module 3</a> . |
| A8B0       | Signal supervision<br>(Editable message text)<br>Programmable warning:<br><a href="#">32.06 Supervision 1 action</a>      | Warning generated by the signal supervision 1 function.  | Check the source of the warning (parameter <a href="#">32.07 Supervision 1 signal</a> ).  |
| A8B1       | Signal supervision 2<br>(Editable message text)<br>Programmable warning:<br><a href="#">32.16 Supervision 2 action</a>    | Warning generated by the signal supervision 2 function.  | Check the source of the warning (parameter <a href="#">32.17 Supervision 2 signal</a> ).  |
| A8B2       | Signal supervision 3<br>(Editable message text)<br>Programmable warning:<br><a href="#">32.26 Supervision 3 action</a>    | Warning generated by the signal supervision 3 function.  | Check the source of the warning (parameter <a href="#">32.27 Supervision 3 signal</a> ).  |
| A8BE       | ULC overload warning<br>Programmable fault:<br><a href="#">37.03 ULC overload actions</a>                                 | Selected signal has exceeded the user overload curve.  | Check for any operating conditions increasing the monitored signal (for example, the loading of the motor if the torque or current is being monitored). Check the definition of the load curve (parameter group <a href="#">37 User load curve</a> ).   |



| Code (hex) | Warning  | Cause   | What to do  |
|------------|--|---|---|
| A8BF       | ULC underload warning<br>Programmable fault:<br><a href="#">37.04 ULC underload actions</a>  | Selected signal has fallen below the user underload curve.  | Check for any operating conditions decreasing the monitored signal (for example, loss of load if the torque or current is being monitored).<br>Check the definition of the load curve (parameter group <a href="#">37 User load curve</a> ).  |
| A8C0       | Fan service counter  | A cooling fan has reached the end of its estimated lifetime. See parameters <a href="#">05.41</a> and <a href="#">05.42</a> .   | Check the auxiliary code. The code indicates which fan is to be replaced.<br>0: Main cooling fan<br>1: Auxiliary cooling fan<br>2: Auxiliary cooling fan 2<br>3: Cabinet cooling fan<br>4: PCB compartment fan<br>Refer to the hardware manual of the drive for fan replacement instructions.                         |
| A981       | External warning 1<br>(Editable message text)<br>Programmable warning:<br><a href="#">31.01 External event 1 source</a><br><a href="#">31.02 External event 1 type</a> | Fault in external device 1.   | Check the external device.<br>Check setting of parameter <a href="#">31.01 External event 1 source</a> .  |
| A982       | External warning 2<br>(Editable message text)<br>Programmable warning:<br><a href="#">31.03 External event 2 source</a><br><a href="#">31.04 External event 2 type</a> | Fault in external device 2.   | Check the external device.<br>Check setting of parameter <a href="#">31.03 External event 2 source</a> .  |
| A983       | External warning 3<br>(Editable message text)<br>Programmable warning:<br><a href="#">31.05 External event 3 source</a><br><a href="#">31.06 External event 3 type</a> | Fault in external device 3.   | Check the external device.<br>Check setting of parameter <a href="#">31.05 External event 3 source</a> .  |
| A984       | External warning 4<br>(Editable message text)<br>Programmable warning:<br><a href="#">31.07 External event 4 source</a><br><a href="#">31.08 External event 4 type</a> | Fault in external device 4.   | Check the external device.<br>Check setting of parameter <a href="#">31.07 External event 4 source</a> .  |
| A985       | External warning 5<br>(Editable message text)<br>Programmable warning:<br><a href="#">31.09 External event 5 source</a><br><a href="#">31.10 External event 5 type</a> | Fault in external device 5.   | Check the external device.<br>Check setting of parameter <a href="#">31.09 External event 5 source</a> .  |
| AF80       | INU-LSU comm loss<br>Programmable warning:<br><a href="#">60.79 INU-LSU comm loss function</a>   | DDCS (fiber optic) communication between converters (for example, the inverter unit and the supply unit) is lost.<br>Note that the inverter unit will continue operating based on the status information that was last received from the other converter. | Check status of other converter (parameters <a href="#">06.36</a> and <a href="#">06.39</a> ).<br>Check settings of parameter group <a href="#">60 DDCS communication</a> . Check the corresponding settings in the control program of the other converter.<br>Check cable connections. If necessary, replace cables. |

| Code (hex) | Warning                       | Cause   | What to do  |
|------------|-------------------------------|---|---|
| AF85       | Line side unit warning        | The supply unit (or other converter) has generated a warning.   | The auxiliary code specifies the original warning code in the supply unit control program. Refer to the firmware manual of the supply unit.   |
| AF8C       | Process PID sleep mode        | The drive is entering sleep mode.   | Informative warning. See section <a href="#">Sleep function for process PID control</a> (page 67), and parameters 40.41...40.48.  |
| AF90       | Speed controller autotuning   | The speed controller autotune routine did not complete successfully.                                      | Check the auxiliary code (format XXXX YYYY). "YYYY" indicates the problem (see actions for each code below).  |
|            | 0000                          | The drive was stopped before the autotune routine finished.   | Repeat autotune until successful.   |
|            | 0001                          | The drive was started but was not ready to follow the autotune command.                                   | Make sure the prerequisites of the autotune run are fulfilled. See section <a href="#">Before activating the autotune routine</a> (page 44).  |
|            | 0002                          | Required torque reference could not be reached before the drive reached maximum speed.                    | Decrease torque step (parameter 25.38) or increase speed step (25.39).  |
|            | 0003                          | Motor could not accelerate/decelerate to maximum/minimum speed.   | Increase torque step (parameter 25.38) or decrease speed step (25.39).  |
|            | 0005                          | Motor could not decelerate with full autotune torque.   | Decrease torque step (parameter 25.38) or speed step (25.39).   |
| AFAA       | Autoreset                     | A fault is about to be autoreset.   | Informative warning. See the settings in parameter group 31 <a href="#">Fault functions</a> .   |
| AFE1       | Emergency stop (off2)         | Drive has received an emergency stop (mode selection off2) command.                                       | Check that it is safe to continue operation. Reset the source of the emergency stop signal (such as an emergency stop push button). Restart drive.<br><br>If the emergency stop was unintentional, check the source of the stop signal (for example, <a href="#">21.05 Emergency stop source</a> , or control word received from an external control system). |
|            |                               | (Follower drive in a master/follower configuration)<br>Drive has received a stop command from the master. | Informative warning. After stopping on a ramp stop (Off1 or Off3) command, the master sends a short, 10-millisecond coast stop (Off2) command to the follower(s). The Off2 stop is stored in the event log of the follower.   |
| AFE2       | Emergency stop (off1 or off3) | Drive has received an emergency stop (mode selection Off1 or Off3) command.                               | Check that it is safe to continue operation. Reset the source of the emergency stop signal (such as an emergency stop push button). Restart drive.<br><br>If the emergency stop was unintentional, check the source of the stop signal (for example, <a href="#">21.05 Emergency stop source</a> , or control word received from an external control system). |

| Code (hex) | Warning   | Cause  | What to do  |
|------------|---|--|---|
| AFE7       | Follower  | A follower drive has tripped.  | Check the auxiliary code. Add 2 to the code to find out the node address of the faulted drive.<br>Correct the fault in the follower drive.  |
| AFEA       | Enable start signal missing<br>(Editable message text)                            | No enable start signal received.   | Check the setting of (and the source selected by) parameter <a href="#">20.19 Enable start command</a> .  |
| AFEB       | Run enable missing<br>(Editable message text)                                     | No run enable signal is received.  | Check setting of parameter <a href="#">20.12 Run enable 1 source</a> . Switch signal on (e.g. in the fieldbus Control Word) or check wiring of selected source.                                       |
| AFEC       | External power signal missing   | <a href="#">95.04 Control board supply</a> is set to <a href="#">External 24V</a> but no voltage is connected to the XPOW connector of the control unit. | Check the external 24 V DC power supply to the control unit, or change the setting of parameter <a href="#">95.04</a> .   |
| AFF6       | Identification run  | Motor ID run will occur at next start, or is in progress.  | Informative warning.  |
| AFF7       | Autophasing   | Autophasing will occur at next start.  | Informative warning.  |
| B5A0       | STO event<br>Programmable event:<br><a href="#">31.22 STO indication run/stop</a> | Safe torque off function is active, i.e. safety circuit signal(s) connected to connector XSTO is lost.   | Check safety circuit connections. For more information, see appropriate drive hardware manual and description of parameter <a href="#">31.22 STO indication run/stop</a> (page <a href="#">267</a> ). |
| B5A2       | Power up<br>Programmable event:<br><a href="#">96.39 Power up event logging</a>   | The drive has been powered up.   | Informative event.  |
| B5A4       | SW internal diagnostics   | Control unit rebooted unexpectedly.  | Informative event.  |
| B686       | Checksum mismatch<br>Programmable event:<br><a href="#">96.54 Checksum action</a> | The calculated parameter checksum does not match any enabled reference checksum.   | See <a href="#">A686 Checksum mismatch</a> (page <a href="#">495</a> ).   |

## Fault messages

| Code (hex) | Fault  | Cause  | What to do  |
|------------|--|--|---|
| 2281       | Calibration  | Measured offset of output phase current measurement or difference between output phase U2 and W2 current measurement is too great (the values are updated during current calibration). | Try performing the current calibration again (select <i>Current measurement calibration</i> at parameter <a href="#">99.13</a> ). If the fault persists, contact your local ABB representative.   |
| 2310       | Overcurrent  | Output current has exceeded internal fault limit.  | <p>Check motor load.</p> <p>Check acceleration times in parameter group <a href="#">23 Speed reference ramp</a> (speed control), <a href="#">26 Torque reference chain</a> (torque control) or <a href="#">28 Frequency reference chain</a> (frequency control). Also check parameters <a href="#">46.01 Speed scaling</a>, <a href="#">46.02 Frequency scaling</a> and <a href="#">46.03 Torque scaling</a>.</p> <p>Check motor and motor cable (including phasing and delta/star connection).</p> <p>Check there are no contactors opening and closing in motor cable.</p> <p>Check that the start-up data in parameter group 99 corresponds to the motor rating plate.</p> <p>Check that there are no power factor correction capacitors or surge absorbers in motor cable.</p> <p>Check encoder cable (including phasing).</p> <p>Check the auxiliary code (format XXXY YYZZ). With parallel-connected inverter modules, "Y YY" specifies through which BCU control unit channel the fault was received. "ZZ" indicates the phase that triggered the fault (<b>0</b>: No detailed information available, <b>1</b>: U-phase, <b>2</b>: V-phase, <b>4</b>: W-phase, <b>3/5/6/7</b>: multiple phases).</p> |
| 2330       | Earth leakage<br>Programmable fault: <a href="#">31.20 Earth fault</a> | Drive has detected load unbalance typically due to earth fault in motor or motor cable.  | <p>Check there are no power factor correction capacitors or surge absorbers in motor cable.</p> <p>Check for an earth fault in motor or motor cables by measuring the insulation resistances of motor and motor cable.</p> <p>Try running the motor in scalar control mode if allowed. (See parameter <a href="#">99.04 Motor control mode</a>.)</p> <p>With parallel-connected modules, check the auxiliary code (format XXXY YYZZ). "Y YY" specifies through which BCU control unit channel the fault was received.</p> <p>If no earth fault can be detected, contact your local ABB representative.</p>  |

| Code (hex) | Fault   | Cause  | What to do  |
|------------|---|--|---|
| 2340       | Short circuit   | Short-circuit in motor cable(s) or motor   | <p>Check motor and motor cable for cabling errors.</p> <p>Check that parameter <a href="#">99.10 Motor nominal power</a> has been set correctly.</p> <p>Check there are no power factor correction capacitors or surge absorbers in motor cable.</p> <p>Check the auxiliary code (format XXXY YYZZ). With parallel-connected inverter modules, "Y YY" specifies through which BCU control unit channel the fault was received. "ZZ" indicates the location of the short circuit (<b>0</b>: No detailed information available, <b>1</b>: Upper branch of U-phase, <b>2</b>: Lower branch of U-phase, <b>4</b>: Upper branch of V-phase, <b>8</b>: Lower branch of V-phase, <b>10</b>: Upper branch of W-phase, <b>20</b>: Lower branch of W-phase, <b>other</b>: combinations of the above).</p> <p>After correcting the cause of the fault, reboot the control unit (using parameter <a href="#">96.08 Control board boot</a>) or by cycling power.</p> |
| 2381       | IGBT overload   | Excessive IGBT junction to case temperature. This fault protects the IGBT(s) and can be activated by a short circuit in the motor cable. | <p>Check motor cable.</p> <p>Check ambient conditions.</p> <p>Check air flow and fan operation.</p> <p>Check heatsink fins for dust pick-up.</p> <p>Check motor power against drive power.</p>  |
| 2391       | BU current difference   | AC phase current difference between parallel-connected inverter modules is excessive.  | <p>Check motor cabling.</p> <p>Check there are no power factor correction capacitors or surge absorbers in motor cable.</p> <p>Check the auxiliary code (format XXXY YYZZ). "XXX" specifies the source of the first error (see "YYY"). "YYY" specifies the module through which BCU control unit channel the fault was received (<b>1</b>: Channel 1, <b>2</b>: Channel 2, <b>4</b>: Channel 3, <b>8</b>: Channel 4, ..., <b>800</b>: Channel 12, <b>other</b>: combinations of the above). "ZZ" indicates the phase (<b>1</b>: U, <b>2</b>: V, <b>3</b>: W).</p>   |
| 2392       | BU earth leakage  | Total earth leakage of inverter modules is excessive.  | <p>Check there are no power factor correction capacitors or surge absorbers in motor cable.</p> <p>Measure insulation resistances of motor cables and motor.</p> <p>Contact your local ABB representative.</p>  |
| 3130       | Input phase loss<br>Programmable fault: <a href="#">31.21 Supply phase loss</a> | Intermediate circuit DC voltage is oscillating due to missing input power line phase or blown fuse.                                      | <p>Check input power line fuses.</p> <p>Check for loose power cable connections.</p> <p>Check for input power supply imbalance.</p>   |
| 3180       | Charge relay lost   | No acknowledgement received from charge relay.   | Contact your local ABB representative.  |

## 510 Fault tracing

| Code (hex) | Fault  | Cause   | What to do  |
|------------|--|---|---|
| 3181       | Wiring or earth fault<br>Programmable fault: <a href="#">31.23</a><br><i>Wiring or earth fault</i> | The drive hardware is supplied from a common DC bus.  | Switch off the protection in parameter <a href="#">31.23</a> .  |
|            |  | Incorrect input power and motor cable connection (i.e. input power cable is connected to the motor connection).                   | Check the power connections.  |
|            |  | Drive has detected load unbalance typically due to earth fault in motor or motor cable.   | Check there are no power factor correction capacitors or surge absorbers in motor cable.<br>Check for an earth fault in motor or motor cables by measuring the insulation resistances of motor and motor cable.<br>Try running the motor in scalar control mode if allowed. (See parameter <a href="#">99.04</a> <i>Motor control mode</i> .)   |
| 3210       | DC link overvoltage  | Excessive intermediate circuit DC voltage.  | Check that overvoltage control is on (parameter <a href="#">30.30</a> <i>Overvoltage control</i> ).<br>Check that the supply voltage matches the nominal input voltage of the drive.<br>Check the supply line for static or transient overvoltage.<br>Check brake chopper and resistor (if present).<br>Check deceleration time.<br>Use coast-to-stop function (if applicable).<br>Retrofit drive with brake chopper and brake resistor.<br>With parallel-connected modules, check the auxiliary code (format XXXY YYZZ). "Y YY" specifies through which BCU control unit channel the fault was received. |
| 3220       | DC link undervoltage   | Intermediate circuit DC voltage is not sufficient because of a missing supply phase, blown fuse or fault in the rectifier bridge. | Check supply cabling, fuses and switchgear.<br>With parallel-connected modules, check the auxiliary code (format XXXY YYZZ). "Y YY" specifies through which BCU control unit channel the fault was received.  |
| 3280       | Standby timeout  | Automatic restart failed (see section <a href="#">Automatic restart</a> on page <a href="#">76</a> ).                             | Check the condition of the supply (voltage, cabling, fuses, switchgear).  |
| 3291       | BU DC link difference  | Difference in DC voltages between parallel-connected inverter modules.  | Check the auxiliary code (format XXXY YYZZ). "XXX" specifies the source of the first error (see "YYY"). "YYY" specifies the module through which BCU control unit channel the fault was received ( <b>1</b> : Channel 1, <b>2</b> : Channel 2, <b>4</b> : Channel 3, <b>8</b> : Channel 4, ..., <b>800</b> : Channel 12).   |
| 3381       | Output phase loss<br>Programmable fault: <a href="#">31.19</a><br><i>Motor phase loss</i>          | Motor circuit fault due to missing motor connection (all three phases are not connected).   | Connect motor cable.  |

| Code (hex) | Fault   | Cause  | What to do  |
|------------|---|--|---|
| 3385       | Autophasing                                       | Autophasing routine (see section <a href="#">Autophasing</a> on page 59) has failed. | <p>Try other autophasing modes (see parameter <a href="#">21.13 Autophasing mode</a>) if possible.</p> <p>If the <a href="#">Turning with Z-pulse</a> mode is selected, check the zero pulse given by the encoder.</p> <p>Check that the motor ID run has been successfully completed.</p> <p>Clear parameter <a href="#">98.15 Position offset user</a>.</p> <p>Check that the encoder is not slipping on the motor shaft.</p> <p>Check that the motor is not already turning when the autophasing routine starts.</p> <p>Check the setting of parameter <a href="#">99.03 Motor type</a>.</p> |
| 4000       | Motor cable overload                              | Calculated motor cable temperature has exceeded warning limit.                       | <p>Check the settings of parameters <a href="#">35.61</a> and <a href="#">35.62</a>.</p> <p>Check the dimensioning of the motor cable in regard to required load.</p>   |
| 4210       | IGBT overtemperature                              | Estimated drive IGBT temperature is excessive.                                       | <p>Check ambient conditions.</p> <p>Check air flow and fan operation.</p> <p>Check heatsink fins for dust pick-up.</p> <p>Check motor power against drive power.</p>  |
| 4290       | Cooling   | Drive module temperature is excessive.   | <p>Check ambient temperature. If it exceeds 40 °C (104 °F), ensure that load current does not exceed derated load capacity of drive. See appropriate <i>Hardware manual</i>.</p> <p>Check drive module cooling air flow and fan operation.</p> <p>Check inside of cabinet and heatsink of drive module for dust pick-up. Clean whenever necessary.</p>  |
| 42F1       | IGBT temperature                                  | Drive IGBT temperature is excessive.   | <p>Check ambient conditions.</p> <p>Check air flow and fan operation.</p> <p>Check heatsink fins for dust pick-up.</p> <p>Check motor power against drive power.</p>  |
| 4310       | Excess temperature                                | Power unit module temperature is excessive.  | See <a href="#">A4B0 Excess temperature</a> (page 493).   |
| 4380       | Excess temperature difference                     | High temperature difference between the IGBTs of different phases.                   | See <a href="#">A4B1 Excess temperature difference</a> (page 493).  |
| 4981       | External temperature 1<br>(Editable message text) | Measured temperature 1 has exceeded fault limit.                                     | <p>Check the value of parameter <a href="#">35.02 Measured temperature 1</a>.</p> <p>Check the cooling of the motor (or other equipment whose temperature is being measured).</p> <p>Check the value of parameter <a href="#">35.12 Temperature 1 fault limit</a>.</p>  |



## 512 Fault tracing

| Code (hex) | Fault   | Cause  | What to do   |
|------------|---|--|--|
| 4982       | External temperature 2<br>(Editable message text)   | Measured temperature 2 has exceeded fault limit.   | Check the value of parameter <a href="#">35.03 Measured temperature 2</a> .<br>Check the cooling of the motor (or other equipment whose temperature is being measured).<br>Check the value of parameter <a href="#">35.22 Temperature 2 fault limit</a> .  |
| 4990       | FPTC not found                                      | A thermistor protection module has been activated by parameter <a href="#">35.30</a> but cannot be detected. | Power down the control unit and make sure that the module is properly inserted in the correct slot.<br>The last digit of the auxiliary code identifies the slot.   |
| 4991       | Safe motor temperature 1<br>(Editable message text) | The thermistor protection module installed in slot 1 indicates overtemperature.                              | Check the cooling of the motor.<br>Check the motor load and drive ratings.<br>Check the wiring of the temperature sensor. Repair wiring if faulty.<br>Measure the resistance of the sensor.<br>Replace sensor if faulty.   |
| 4992       | Safe motor temperature 2<br>(Editable message text) | The thermistor protection module installed in slot 2 indicates overtemperature.                              |  |
| 4993       | Safe motor temperature 3<br>(Editable message text) | The thermistor protection module installed in slot 3 indicates overtemperature.                              |  |
| 5080       | Fan   | Cooling fan feedback missing.  | See <a href="#">A581 Fan</a> (page <a href="#">494</a> ).  |
| 5081       | Auxiliary fan broken                                | An auxiliary cooling fan (connected to the fan connectors on the control unit) is stuck or disconnected.     | Check the auxiliary code. The auxiliary code identifies the fan (1: Auxiliary fan 1, 2: Auxiliary fan 2).<br>Check auxiliary fan(s) and connection(s).<br>Replace faulty fan.<br>Make sure the front cover of the drive module is in place and tightened. If the commissioning of the drive requires that the cover is off, activate parameter <a href="#">31.36 Aux fan fault bypass</a> within 2 minutes from control unit reboot to temporarily suppress the fault.   |
| 5090       | STO hardware failure                                | Safe torque off hardware failure.  | Contact your local ABB representative, quoting the auxiliary code. The code contains location information, especially with parallel-connected inverter modules. When converted into a 32-bit binary number, the bits of the code indicate the following:<br>31...28: Number of faulty inverter module (0...11 decimal). 1111: STO_ACT states of control unit and inverter modules in conflict<br>27: STO_ACT state of inverter modules<br>26: STO_ACT state of control unit<br>25: STO1 of control unit<br>24: STO2 of control unit<br>23...12: STO1 of inverter modules 12...1 (Bits of non-existing modules set to 1)<br>11...0: STO2 of inverter modules 12...1 (Bits of non-existing modules set to 1) |



| Code (hex) | Fault  | Cause  | What to do   |
|------------|--|--|--|
| 5091       | Safe torque off<br>Programmable fault: <a href="#">31.22 STO indication run/stop</a> | Safe torque off function is active, i.e. safety circuit signal(s) connected to connector XSTO is broken during start or run.                               | Check safe torque off circuit connections. For more information, see appropriate drive hardware manual and description of parameter <a href="#">31.22 STO indication run/stop</a> (page <a href="#">267</a> ).   |
| 5092       | PU logic error   | Power unit memory has cleared.   | Cycle the power to the drive. If the control unit is externally powered, also reboot the control unit (using parameter <a href="#">96.08 Control board boot</a> ) or by cycling its power. If the problem persists, contact your local ABB representative.   |
| 5093       | Rating ID mismatch   | The hardware of the drive does not match the information stored in the memory unit. This may occur eg. after a firmware update or memory unit replacement. | Cycle the power to the drive. Check the auxiliary code. The auxiliary code categories are as follows:<br>1 = PU and CU ratings not the same. Rating ID has changed.<br>2 = Parallel connection rating ID has changed.<br>3 = PU types not the same in all power units.<br>4 = Parallel connection rating ID is active in a single power unit setup.<br>5 = It is not possible to implement the selected rating with the current PUs.<br>6 = PU rating ID is 0.<br>7 = Reading PU rating ID or PU type failed on PU connection.<br>8 = PU not supported (illegal rating ID).<br>9 = Incompatible module current rating (unit contains a module with too low a current rating).<br>10 = Selected parallel rating ID not found from database.<br>With parallel connection faults (BCU control unit), the format of the auxiliary code is 0X0Y. "Y" indicates the auxiliary code category, "X" indicates the first faulty PU channel in hexadecimal (1...C). (With a ZCU control unit, "X" can be 1 or 2 but this is irrelevant to the fault.) |
| 5094       | Measurement circuit temperature  | Problem with internal temperature measurement of the drive.  | See <a href="#">A5EA Measurement circuit temperature</a> (page <a href="#">494</a> ).  |

| Code (hex) | Fault                          | Cause  | What to do  |
|------------|--------------------------------|--|---|
| 5681       | PU communication               | The way the control unit is powered does not correspond to parameter setting.                                      | Check setting of <a href="#">95.04 Control board supply</a> .   |
|            |                                | Communication errors detected between the drive control unit and the power unit.                                   | Check the connection between the control unit and the power unit.<br>Check the auxiliary code (format XXXY YYZZ). With parallel-connected modules, "YY YY" specifies the affected BCU control unit channel ( <b>0</b> : broadcast). "ZZ" specifies the error source ( <b>1</b> : Transmitter side [link error], <b>2</b> : Transmitter side [no communication], <b>3</b> : Receiver side [link error], <b>4</b> : Receiver side [no communication], <b>5</b> : Transmitter FIFO error [see "XXX"], <b>6</b> : Module [xINT board] not found, <b>7</b> : BAMU board not found). "XXX" specifies the transmitter FIFO error code ( <b>1</b> : Internal error [invalid call parameter], <b>2</b> : Internal error [configuration not supported], <b>3</b> : Transmission buffer full). |
| 5682       | Power unit lost                | Connection between the drive control unit and the power unit is lost.  | Check the connection between the control unit and the power unit.   |
| 5690       | PU communication internal      | Internal communication error.  | Contact your local ABB representative.  |
| 5691       | Measurement circuit ADC        | Measurement circuit fault.   | Contact your local ABB representative, quoting the auxiliary code.  |
| 5692       | PU board powerfail             | Power unit power supply failure.   | Check the auxiliary code (format ZZZY YYXX). "YY Y" specifies the affected inverter module ( <b>0...C</b> , always <b>0</b> for ZCU control units). "XX" specifies the affected power supply ( <b>1</b> : Power supply 1, <b>2</b> : Power supply 2, <b>3</b> : both supplies).   |
| 5693       | Measurement circuit DFF        | Measurement circuit fault.   | Contact your local ABB representative, quoting the auxiliary code.  |
| 5694       | PU communication configuration | Number of connected power modules differs from expected.   | Check setting of <a href="#">95.31 Parallel connection rating id</a> . Cycle the power to the drive. If the control unit is externally powered, also reboot the control unit (using parameter <a href="#">96.08 Control board boot</a> ) or by cycling its power.<br>If the problem persists, contact your local ABB representative.  |
| 5695       | Reduced run                    | Number of inverter modules detected does not match the value of parameter <a href="#">95.13 Reduced run mode</a> . | Check that the value of <a href="#">95.13 Reduced run mode</a> corresponds to the number of inverter modules present. Check that the modules present are powered from the DC bus and connected by fiber optic cables to the BCU control unit.<br>If all modules of the inverter unit are in fact available (eg. maintenance work has been completed), check that parameter <a href="#">95.13</a> is set to 0 (reduced run function disabled).   |

| Code (hex) | Fault  | Cause   | What to do  |
|------------|--|---|---|
| 5696       | PU state feedback  | State feedback from output phases does not match control signals.   | Contact your local ABB representative, quoting the auxiliary code.  |
| 5697       | Charging feedback  | Incorrect parameter setting.  | Check the setting of <a href="#">95.09 Switch fuse controller</a> . The parameter should be enabled only if an xSFC charging controller is installed.   |
|            |  | The charging switch and DC switch were operated out of sequence, or a start command was issued before the unit was ready. | The normal power-up sequence is:<br>1. Close charging switch.<br>2. After charging finishes (charging OK lamp lights), close DC switch.<br>3. Open charging switch.   |
|            |  | Charging circuit fault.   | Check the charging circuit.<br>With a frame R6i/R7i inverter module, the auxiliary code "FA" indicates that the charging contactor status feedback does not match the control signal.<br>With parallel-connected frame R8i modules, the auxiliary code (format XX00), "XX" specifies the affected BCU control unit channel. |
| 5698       | Unknown power unit fault   | Unidentified power unit logic fault.  | Check power unit logic and firmware compatibility.<br>Contact your local ABB representative.  |
| 6000       | Internal SW error  | Internal error.   | Contact your local ABB representative, quoting the auxiliary code.  |
| 6181       | FPGA version incompatible  | Firmware and FPGA file version in the power unit are incompatible.  | Reboot the control unit (using parameter <a href="#">96.08 Control board boot</a> ) or by cycling power. If the problem persists, contact your local ABB representative.  |
|            |  | Update of power unit logic failed.  | Retry.  |
| 6200       | Checksum mismatch<br>Programmable fault: <a href="#">96.54 Checksum action</a> | The calculated parameter checksum does not match any enabled reference checksum.  | See <a href="#">A686 Checksum mismatch</a> (page 495).  |
| 6306       | FBA A mapping file   | Fieldbus adapter A mapping file read error.   | Contact your local ABB representative.  |
| 6307       | FBA B mapping file   | Fieldbus adapter B mapping file read error.   | Contact your local ABB representative.  |
| 6481       | Task overload  | Internal fault.   | Reboot the control unit (using parameter <a href="#">96.08 Control board boot</a> ) or by cycling power. If the problem persists, contact your local ABB representative.  |
| 6487       | Stack overflow   | Internal fault.   | Reboot the control unit (using parameter <a href="#">96.08 Control board boot</a> ) or by cycling power. If the problem persists, contact your local ABB representative.  |
| 64A1       | Internal file load   | File read error.  | Reboot the control unit (using parameter <a href="#">96.08 Control board boot</a> ) or by cycling power. If the problem persists, contact your local ABB representative.  |
| 64A2       | Internal record load   | Internal record load error.   | Contact your local ABB representative.  |

| Code (hex) | Fault               | Cause   | What to do   |
|------------|---------------------|---|--|
| 64A3       | Application loading | Application file incompatible or corrupted.   | Check the auxiliary code. See actions for each code below.   |
|            | 8006                | Not enough memory for the application.  | Reduce the size of the application.<br>Reduce the number of parameter mappings.<br>See the drive-specific log generated by Automation Builder.   |
|            | 8007                | The application contains the wrong system library version.  | Update the system library or reinstall Automation Builder.<br>See the drive-specific log generated by Automation Builder.  |
|            | 8008                | The application is empty.   | In Automation Builder, give a “Clean” command and reload the application.  |
|            | 8009                | The application contains invalid tasks.   | In Automation Builder, check application task configuration, give a “Clean all” command, and reload the application.   |
|            | 800A                | The application contains an unknown target (system) library function.   | Update the system library or reinstall Automation Builder.<br>See the drive-specific log generated by Automation Builder.  |
| 64A5       | Licensing fault     | Running the control program is prevented either because a restrictive license exists, or because a required license is missing. | Record the auxiliary codes of all active licensing faults and contact your product vendor for further instructions.  |
| 64A6       | Adaptive program    | Error running the adaptive program.   | Check the auxiliary code (format XXXX YYYY). “XXXX” specifies the number of the function block ( <b>0000</b> = generic error). “YYYY” indicates the problem (see actions for each code below). |
|            | 000A                | Program corrupted or block non-existent   | Restore the template program or download the program to the drive.   |
|            | 000C                | Required block input missing  | Check the inputs of the block.   |
|            | 000E                | Program corrupted or block non-existent   | Restore the template program or download the program to the drive.   |
|            | 0011                | Program too large.  | Remove blocks until the error stops.   |
|            | 0012                | Program is empty.   | Correct the program and download it to the drive.  |
|            | 001C                | A nonexisting parameter or block is used in the program.  | Edit the program to correct the parameter reference, or to use an existing block.  |
|            | 001D                | Parameter type invalid for selected pin.  | Edit the program to correct the parameter reference.   |
|            | 001E                | Output to parameter failed because the parameter was write-protected.   | Check the parameter reference in the program.<br>Check for other sources affecting the target parameter.   |
|            | 0023                | Program file incompatible with current firmware version.  | Adapt the program to current block library and firmware version.   |
|            | 0024                |   |  |
|            | 002A                | Too many blocks.  | Edit the program to reduce the number of blocks.   |

| Code (hex) | Fault   | Cause   | What to do  |
|------------|---|---|---|
|            | Other   | –   | Contact your local ABB representative, quoting the auxiliary code.  |
| 64B0       | Memory unit detached  | The memory unit was detached when the control unit was powered.   | Switch off the power to the control unit and reinstall the memory unit.<br>In case the memory unit was not actually removed when the fault occurred, check that the memory unit is properly inserted into its connector and its mounting screw is tight. Reboot the control unit (using parameter <a href="#">96.08 Control board boot</a> ) or by cycling power. If the problem persists, contact your local ABB representative. |
| 64B1       | Internal SSW fault  | Internal fault.   | Reboot the control unit (using parameter <a href="#">96.08 Control board boot</a> ) or by cycling power. If the problem persists, contact your local ABB representative.  |
| 64B2       | User set fault  | Loading of user parameter set failed because <ul style="list-style-type: none"> <li>• requested set does not exist</li> <li>• set is not compatible with control program</li> <li>• drive was switched off during loading.</li> </ul> | Ensure that a valid user parameter set exists. Reload if uncertain.   |
| 64E1       | Kernel overload   | Operating system error.   | Reboot the control unit (using parameter <a href="#">96.08 Control board boot</a> ) or by cycling power. If the problem persists, contact your local ABB representative.  |
| 6581       | Parameter system  | Parameter load or save failed.  | Try forcing a save using parameter <a href="#">96.07 Parameter save manually</a> . Retry.   |
| 65A1       | FBA A parameter conflict  | The drive does not have a functionality requested by PLC, or requested functionality has not been activated.  | Check PLC programming.<br>Check settings of parameter groups <a href="#">50 Fieldbus adapter (FBA)</a> and <a href="#">51 FBA A settings</a> .  |
| 65A2       | FBA B parameter conflict  | The drive does not have a functionality requested by PLC, or requested functionality has not been activated.  | Check PLC programming.<br>Check settings of parameter groups <a href="#">50 Fieldbus adapter (FBA)</a> and <a href="#">54 FBA B settings</a> .  |
| 65B1       | Reference source parametrization  | A reference source is simultaneously connected to multiple parameters with different units.   | See <a href="#">A6DA Reference source parametrization</a> (page 497).   |
| 6681       | EFB comm loss<br>Programmable fault:<br><a href="#">58.14 Communication loss action</a> | Communication break in embedded fieldbus (EFB) communication.   | Check the status of the fieldbus master (online/offline/error etc.).<br>Check cable connections to the XD2D connector on the control unit.  |
| 6682       | EFB config file   | Embedded fieldbus (EFB) configuration file could not be read.   | Contact your local ABB representative.  |
| 6683       | EFB invalid parameterization  | Embedded fieldbus (EFB) parameter settings inconsistent or not compatible with selected protocol.   | Check the settings in parameter group <a href="#">58 Embedded fieldbus</a> .  |

## 518 Fault tracing

| Code (hex) | Fault   | Cause   | What to do   |
|------------|---|---|--|
| 6684       | EFB load fault  | Embedded fieldbus (EFB) protocol firmware could not be loaded.                                  | Contact your local ABB representative.   |
|            |   | Version mismatch between EFB protocol firmware and drive firmware.                              |  |
| 6881       | Text data overflow  | Internal fault.   | Reset the fault. Contact your local ABB representative if the fault persists.  |
| 6882       | Text 32-bit table overflow  | Internal fault.   | Reset the fault. Contact your local ABB representative if the fault persists.  |
| 6883       | Text 64-bit table overflow  | Internal fault.   | Reset the fault. Contact your local ABB representative if the fault persists.  |
| 6885       | Text file overflow  | Internal fault.   | Reset the fault. Contact your local ABB representative if the fault persists.  |
| 7080       | Option module comm loss   | Communication between drive and an option module is lost.                                       | See <a href="#">A798 Encoder option comm loss</a> (page 499).  |
| 7081       | Control panel loss<br>Programmable fault: <a href="#">49.05 Communication loss action</a> | Control panel (or PC tool) has stopped communicating.   | Check PC tool or control panel connection.<br>Check control panel connector. Disconnect and reconnect the control panel.<br>Check the auxiliary code. The code specifies the I/O port used as follows: <b>0</b> : Panel, <b>1</b> : Fieldbus interface A, <b>2</b> : Fieldbus interface B, <b>3</b> : Ethernet, <b>4</b> : D2D/EFB port).                        |
| 7082       | Ext I/O comm loss   | The I/O extension module types specified by parameters do not match the detected configuration. | Check the auxiliary code (format XXYY YYYY). "XX" specifies the number of the I/O extension module ( <b>01</b> : parameter group <a href="#">14 I/O extension module 1</a> , <b>02</b> : <a href="#">15 I/O extension module 2</a> , <b>03</b> : <a href="#">16 I/O extension module 3</a> ). "YY YYYY" indicates the problem (see actions for each code below). |
|            | 00 0001   | Communication with module failed.   | Check that the module is properly seated in its slot.<br>Check that the module and the slot connector is not damaged.<br>Try installing the module into another slot.  |
|            | 00 0002   | Module not found.   | Check the type and location settings of the modules (parameters <a href="#">14.01/14.02</a> , <a href="#">15.01/15.02</a> or <a href="#">16.01/16.02</a> ).  |
|            | 00 0003   | Configuration of module failed.   |  |
|            | 00 0004   | Configuration of module failed.   |  |
|            | 00 0004   | Configuration of module failed.   | Check that the module is properly seated in its slot.<br>Check that the module and the slot connector is not damaged.<br>Try installing the module into another slot.  |
| 7083       | Panel reference conflict  | Use of saved control panel reference in multiple control modes attempted.                       | The control panel reference can only be saved for one reference type at a time. Consider the possibility of using a copied reference instead of saved reference (see the reference selection parameter).   |

| Code (hex) | Fault   | Cause  | What to do  |
|------------|---|--|---|
| 7084       | Panel/PC tool version conflict  | The current version of the control panel and/or PC tool does not support a function. (For example, older panel versions cannot be used as a source of external reference.) | Update control panel and/or PC tool. Contact your local ABB representative if necessary.  |
| 7085       | Incompatible option module  | Option module not supported. (For example, type Fxxx-xx-M fieldbus adapter modules are not supported.)   | Check the auxiliary code. The code specifies the interface to which the unsupported module is connected: <b>1</b> : Fieldbus interface A, <b>2</b> : Fieldbus interface B.<br>Replace the module with a supported type.   |
| 7121       | Motor stall<br>Programmable fault: <a href="#">31.24 Stall function</a> | Motor is operating in stall region because of e.g. excessive load or insufficient motor power.   | Check motor load and drive ratings. Check fault function parameters.  |
| 7181       | Brake resistor  | Brake resistor broken or not connected.  | Check that a brake resistor has been connected.<br>Check the condition of the brake resistor.<br>Check the dimensioning of the brake resistor.  |
| 7183       | BR excess temperature   | Brake resistor temperature has exceeded fault limit defined by parameter <a href="#">43.11 Brake resistor fault limit</a> .  | Stop drive. Let resistor cool down.<br>Check resistor overload protection function settings (parameter group <a href="#">43 Brake chopper</a> ).<br>Check fault limit setting, parameter <a href="#">43.11 Brake resistor fault limit</a> .<br>Check that braking cycle meets allowed limits.   |
| 7184       | Brake resistor wiring   | Brake resistor short circuit or brake chopper control fault.   | Check brake chopper and brake resistor connection.<br>Ensure brake resistor is not damaged.<br>After correcting the cause of the fault, reboot the control unit (using parameter <a href="#">96.08 Control board boot</a> ) or by cycling power.  |
| 7191       | BC short circuit  | Short circuit in brake chopper IGBT.   | Ensure brake resistor is connected and not damaged.<br>Check the electrical specifications of the brake resistor against the <i>Hardware manual</i> .<br>Replace brake chopper (if replaceable).<br>After correcting the cause of the fault, reboot the control unit (using parameter <a href="#">96.08 Control board boot</a> ) or by cycling power. |

| Code (hex) | Fault  | Cause  | What to do   |
|------------|--|--|--|
| 7192       | BC IGBT excess temperature   | Brake chopper IGBT temperature has exceeded internal fault limit.  | Let chopper cool down.<br>Check for excessive ambient temperature.<br>Check for cooling fan failure.<br>Check for obstructions in the air flow.<br>Check the dimensioning and cooling of the cabinet.<br>Check resistor overload protection function settings (parameter group <a href="#">43 Brake chopper</a> ).<br>Check that braking cycle meets allowed limits.<br>Check that drive supply AC voltage is not excessive. |
| 71A2       | Mechanical brake closing failed<br>Programmable fault: <a href="#">44.17 Brake fault function</a>      | Mechanical brake control fault. Activated eg. if brake acknowledgement is not as expected during brake closing.  | Check mechanical brake connection.<br>Check mechanical brake settings in parameter group <a href="#">44 Mechanical brake control</a> .<br>Check that acknowledgement signal matches actual status of brake.  |
| 71A3       | Mechanical brake opening failed<br>Programmable fault: <a href="#">44.17 Brake fault function</a>      | Mechanical brake control fault. Activated eg. if brake acknowledgement is not as expected during brake opening.  | Check mechanical brake connection.<br>Check mechanical brake settings in parameter group <a href="#">44 Mechanical brake control</a> .<br>Check that acknowledgement signal matches actual status of brake.  |
| 71A5       | Mechanical brake opening not allowed<br>Programmable fault: <a href="#">44.17 Brake fault function</a> | Open conditions of mechanical brake cannot be fulfilled (for example, brake has been prevented from opening by parameter <a href="#">44.11 Keep brake closed</a> ).  | Check mechanical brake settings in parameter group <a href="#">44 Mechanical brake control</a> (especially <a href="#">44.11 Keep brake closed</a> ).<br>Check that acknowledgement signal (if used) matches actual status of brake.   |
|            |  | In an encoderless application, the brake is kept closed by a brake close request (either from parameter <a href="#">44.12 Brake close request</a> or from an FSO-xx safety functions module) against a modulating drive for longer than 5 seconds. | Check the source signal selected by parameter <a href="#">44.12 Brake close request</a> .<br>Check the safety circuits connected to the FSO-xx safety functions module.  |
| 71B1       | Motor fan<br>Programmable fault: <a href="#">35.106 DOL starter event type</a>                         | No feedback received from external fan.  | Check external fan (or other equipment controlled) by the logic.<br>Check settings of parameters <a href="#">35.100...35.106</a> .   |
| 7301       | Motor speed feedback<br>Programmable fault: <a href="#">90.45 Motor feedback fault</a>                 | No motor speed feedback received.  | See <a href="#">A7B0 Motor speed feedback</a> (page <a href="#">501</a> ).   |



| Code (hex) | Fault  | Cause  | What to do  |
|------------|--|--|---|
| 7310       | Overspeed  | Motor is turning faster than highest allowed speed due to incorrectly set minimum/maximum speed, insufficient braking torque or changes in load when using torque reference. | Check minimum/maximum speed settings, parameters <a href="#">30.11 Minimum speed</a> , <a href="#">30.12 Maximum speed</a> and <a href="#">31.30 Overspeed trip margin</a> .<br>Check adequacy of motor braking torque. Check applicability of torque control. Check need for brake chopper and resistor(s).  |
|            |  | Incorrect estimated speed.   | Check the status of motor current measurement.<br>Perform a <a href="#">Normal</a> , <a href="#">Advanced</a> or <a href="#">Advanced Standstill</a> ID run instead of, for example, a <a href="#">Reduced</a> or <a href="#">Standstill</a> ID run. See parameter <a href="#">99.13 ID run requested</a> (page 426).   |
| 7380       | Encoder internal   | Internal fault.  | Contact your local ABB representative.  |
| 7381       | Encoder<br>Programmable fault: <a href="#">90.45 Motor feedback fault</a>      | Encoder feedback fault.  | See <a href="#">A7E1 Encoder</a> (page 502).  |
| 73A0       | Speed feedback configuration   | Speed feedback configuration incorrect.  | See <a href="#">A797 Speed feedback configuration</a> (page 498).   |
| 73A1       | Load feedback<br>Programmable fault: <a href="#">90.55 Load feedback fault</a> | No load feedback received.   | Check the auxiliary code (format XXYY ZZZZ). "XX" specifies the number of the encoder interface module ( <b>01</b> : <a href="#">91.11/91.12</a> , <b>02</b> : <a href="#">91.13/91.14</a> ), "YY" specifies the encoder ( <b>01</b> : <a href="#">92 Encoder 1 configuration</a> , <b>02</b> : <a href="#">93 Encoder 2 configuration</a> ). "ZZZZ" indicates the problem (see actions for each code below). |
|            |  | 0001 Load gear definition invalid or outside limits.   | Check load gear settings ( <a href="#">90.53</a> and <a href="#">90.54</a> ).   |
|            |  | 0002 Feed constant definition invalid or outside limits.   | Check feed constant settings ( <a href="#">90.63</a> and <a href="#">90.64</a> ).   |
|            |  | 0003 Motor/load gear definition invalid or outside limits.   | Check motor/load gear settings ( <a href="#">90.61</a> and <a href="#">90.62</a> ).   |
|            |  | 0004 Encoder not configured.   | Check encoder settings ( <a href="#">92 Encoder 1 configuration</a> or <a href="#">93 Encoder 2 configuration</a> ).<br>Use parameter <a href="#">91.10 Encoder parameter refresh</a> to validate any changes in the settings.  |
|            |  | 0005 Encoder stopped working.  | Check encoder status.   |
| 73B0       | Emergency ramp failed  | Emergency stop did not finish within expected time.  | Check the settings of parameters <a href="#">31.32 Emergency ramp supervision</a> and <a href="#">31.33 Emergency ramp supervision delay</a> .<br>Check the predefined ramp times ( <a href="#">23.11...23.19</a> for mode Off1, <a href="#">23.23</a> for mode Off3).  |

## 522 Fault tracing

| Code (hex) | Fault   | Cause  | What to do  |
|------------|---|--|---|
| 73B1       | Stop failed   | Ramp stop did not finish within expected time.   | Check the settings of parameters <a href="#">31.37 Ramp stop supervision</a> and <a href="#">31.38 Ramp stop supervision delay</a> .<br>Check the predefined ramp times in parameter group <a href="#">23 Speed reference ramp</a> .  |
| 73F0       | Overfrequency   | Maximum allowed output frequency exceeded.   | Without a dual-use license, the fault limit is 598 Hz. Contact your local ABB representative for dual-use licensing information.  |
| 7510       | FBA A communication<br>Programmable fault: <a href="#">50.02 FBA A comm loss func</a>                     | Cyclical communication between drive and fieldbus adapter module A or between PLC and fieldbus adapter module A is lost. | Check status of fieldbus communication. See user documentation of fieldbus interface.<br>Check settings of parameter groups <a href="#">50 Fieldbus adapter (FBA)</a> , <a href="#">51 FBA A settings</a> , <a href="#">52 FBA A data in</a> and <a href="#">53 FBA A data out</a> .<br>Check cable connections.<br>Check if communication master is able to communicate. |
| 7520       | FBA B communication<br>Programmable fault: <a href="#">50.32 FBA B comm loss func</a>                     | Cyclical communication between drive and fieldbus adapter module B or between PLC and fieldbus adapter module B is lost. | Check status of fieldbus communication. See user documentation of fieldbus interface.<br>Check settings of parameter group <a href="#">50 Fieldbus adapter (FBA)</a> .<br>Check cable connections.<br>Check if communication master is able to communicate.   |
| 7580       | INU-LSU comm loss<br>Programmable fault: <a href="#">60.79 INU-LSU comm loss function</a>                 | DDCS (fiber optic) communication between converters (for example, the inverter unit and the supply unit) is lost.        | Check status of other converter (parameter group <a href="#">06 Control and status words</a> ).<br>Check settings of parameter group <a href="#">60 DDCS communication</a> . Check the corresponding settings in the control program of the other converter.<br>Check cable connections. If necessary, replace cables.  |
| 7581       | DDCS controller comm loss<br>Programmable fault: <a href="#">60.59 DDCS controller comm loss function</a> | DDCS (fiber optic) communication between drive and external controller is lost.  | Check status of controller. See user documentation of controller.<br>Check settings of parameter group <a href="#">60 DDCS communication</a> .<br>Check cable connections. If necessary, replace cables.  |
| 7582       | MF comm loss<br>Programmable fault: <a href="#">60.09 M/F comm loss function</a>                          | Master/follower communication is lost.   | See <a href="#">A7CB MF comm loss</a> (page 502).   |
| 7583       | Line side unit faulted  | The supply unit (or other converter) connected to the inverter unit has generated a fault.                               | The auxiliary code specifies the original fault code in the supply unit control program. Refer to the firmware manual of the supply unit.   |

| Code (hex) | Fault   | Cause  | What to do  |
|------------|---|--|---|
| 7584       | LSU charge failed   | The supply unit was not ready (ie. the main contactor/breaker could not be closed) within expected time. | Check that communication to the supply unit has been activated by <a href="#">95.20 HW options word 1</a> .<br>Check setting of parameter <a href="#">94.10 LSU max charging time</a> .<br>Check that the supply unit is enabled, allowed to start, and can be controlled by the inverter unit (eg. not in local control mode).   |
| 8001       | ULC underload fault<br>Programmable fault: <a href="#">37.04 ULC underload actions</a>  | Selected signal has fallen below the user underload curve.   | See <a href="#">A8BF ULC underload warning</a> (page 505).  |
| 8002       | ULC overload fault<br>Programmable fault: <a href="#">37.03 ULC overload actions</a>  | Selected signal has exceeded the user overload curve.  | See <a href="#">A8BE ULC overload warning</a> (page 504).   |
| 80A0       | AI supervision<br>Programmable fault: <a href="#">12.03 AI supervision function</a>   | An analog signal is outside the limits specified for the analog input.                                   | Check the auxiliary code (format XXXX XYZZ). "Y" specifies the location of the input ( <b>0</b> : Control unit, <b>1</b> : I/O extension module 1, <b>2</b> : I/O extension module 2, <b>3</b> : I/O extension module 3). "ZZ" specifies the limit ( <b>01</b> : AI1 under minimum, <b>02</b> : AI1 above maximum, <b>03</b> : AI2 under minimum, <b>04</b> : AI2 above maximum).<br>Check signal level at the analog input.<br>Check the wiring connected to the input.<br>Check the minimum and maximum limits of the input in parameter group <a href="#">12 Standard AI</a> . |
| 80B0       | Signal supervision<br>(Editable message text)<br>Programmable fault: <a href="#">32.06 Supervision 1 action</a>   | Fault generated by the signal supervision 1 function.  | Check the source of the fault (parameter <a href="#">32.07 Supervision 1 signal</a> ).  |
| 80B1       | Signal supervision 2<br>(Editable message text)<br>Programmable fault: <a href="#">32.16 Supervision 2 action</a>   | Fault generated by the signal supervision 2 function.  | Check the source of the fault (parameter <a href="#">32.17 Supervision 2 signal</a> ).  |
| 80B2       | Signal supervision 3<br>(Editable message text)<br>Programmable fault: <a href="#">32.26 Supervision 3 action</a>   | Fault generated by the signal supervision 3 function.  | Check the source of the fault (parameter <a href="#">32.27 Supervision 3 signal</a> ).  |
| 9081       | External fault 1<br>(Editable message text)<br>Programmable fault: <a href="#">31.01 External event 1 source</a><br><a href="#">31.02 External event 1 type</a> | Fault in external device 1.  | Check the external device.<br>Check setting of parameter <a href="#">31.01 External event 1 source</a> .  |
| 9082       | External fault 2<br>(Editable message text)<br>Programmable fault: <a href="#">31.03 External event 2 source</a><br><a href="#">31.04 External event 2 type</a> | Fault in external device 2.  | Check the external device.<br>Check setting of parameter <a href="#">31.03 External event 2 source</a> .  |

| Code (hex) | Fault   | Cause  | What to do   |
|------------|---|--|--|
| 9083       | External fault 3<br>(Editable message text)<br>Programmable fault: <a href="#">31.05 External event 3 source</a><br><a href="#">31.06 External event 3 type</a> | Fault in external device 3.  | Check the external device.<br>Check setting of parameter <a href="#">31.05 External event 3 source</a> .   |
| 9084       | External fault 4<br>(Editable message text)<br>Programmable fault: <a href="#">31.07 External event 4 source</a><br><a href="#">31.08 External event 4 type</a> | Fault in external device 4.  | Check the external device.<br>Check setting of parameter <a href="#">31.07 External event 4 source</a> .   |
| 9085       | External fault 5<br>(Editable message text)<br>Programmable fault: <a href="#">31.09 External event 5 source</a><br><a href="#">31.10 External event 5 type</a> | Fault in external device 5.  | Check the external device.<br>Check setting of parameter <a href="#">31.09 External event 5 source</a> .   |
| FA81       | Safe torque off 1 loss  | Safe torque off function is active, ie. STO circuit 1 is broken.         | Check safety circuit connections. For more information, see appropriate drive hardware manual and description of parameter <a href="#">31.22 STO indication run/stop</a> (page <a href="#">267</a> ).<br>Check the auxiliary code, The code contains location information, especially with parallel-connected inverter modules. When converted into a 32-bit binary number, the bits of the code indicate the following:<br>31...28: Number of faulty inverter module (0...11 decimal). 1111: STO_ACT states of control unit and inverter modules in conflict<br>27: STO_ACT state of inverter modules<br>26: STO_ACT state of control unit<br>25: STO1 of control unit<br>24: STO2 of control unit<br>23...12: STO1 of inverter modules 12...1 (Bits of non-existing modules set to 1)<br>11...0: STO2 of inverter modules 12...1 (Bits of non-existing modules set to 1) |
| FA82       | Safe torque off 2 loss  | Safe torque off function is active, ie. STO circuit 2 is broken.         |  |
| FB11       | Memory unit missing   | No memory unit is attached to the control unit.                          | Power down the control unit.<br>Check that the memory unit is properly inserted into the control unit.   |
|            |   | The memory unit attached to the control unit is empty.                   | Power down the control unit. Attach a memory unit (with the appropriate firmware) to the control unit.   |
| FB12       | Memory unit incompatible  | The memory unit attached to the control unit is incompatible.            | Power down the control unit.<br>Attach a compatible memory unit.   |
| FB13       | Memory unit FW incompatible   | The firmware on the attached memory unit is incompatible with the drive. | Power down the control unit.<br>Attach a memory unit with compatible firmware.   |

| Code (hex) | Fault                      | Cause   | What to do  |
|------------|----------------------------|---|---|
| FB14       | Memory unit FW load failed | The firmware on the attached memory unit could not be loaded to the drive.                  | Power down the control unit.<br>Check that the memory unit is properly inserted into the control unit.<br>If the problem persists, replace the memory unit.   |
| FF61       | ID run                     | Motor ID run was not completed successfully.  | Check the nominal motor values in parameter group <a href="#">99 Motor data</a> .<br>Check that no external control system is connected to the drive.<br>Cycle the power to the drive (and its control unit, if powered separately).<br>Check that the motor shaft is not locked.<br>Check the auxiliary code. The second number of the code indicates the problem (see actions for each code below).   |
|            | 0001                       | Maximum current limit too low.  | Check settings of parameters <a href="#">99.06 Motor nominal current</a> and <a href="#">30.17 Maximum current</a> . Make sure that $30.17 > 99.06$ .<br>Check that the drive is dimensioned correctly according to the motor.  |
|            | 0002                       | Maximum speed limit or calculated field weakening point too low.                            | Check settings of parameters <ul style="list-style-type: none"> <li><a href="#">30.11 Minimum speed</a></li> <li><a href="#">30.12 Maximum speed</a></li> <li><a href="#">99.07 Motor nominal voltage</a></li> <li><a href="#">99.08 Motor nominal frequency</a></li> <li><a href="#">99.09 Motor nominal speed</a>.</li> </ul> Make sure that <ul style="list-style-type: none"> <li><math>30.12 &gt; (0.55 \times 99.09) &gt; (0.50 \times \text{synchronous speed})</math></li> <li><math>30.11 \leq 0</math>, and</li> <li>supply voltage <math>\geq (0.66 \times 99.07)</math>.</li> </ul> |
|            | 0003                       | Maximum torque limit too low.   | Check settings of parameter <a href="#">99.12 Motor nominal torque</a> , and the torque limits in group <a href="#">30 Limits</a> .<br>Make sure that the maximum torque limit in force is greater than 100%.   |
|            | 0004                       | Current measurement calibration did not finish within reasonable time.                      | Contact your local ABB representative.  |
|            | 0005...0008                | Internal error.   | Contact your local ABB representative.  |
|            | 0009                       | (Asynchronous motors only)<br>Acceleration did not finish within reasonable time.           | Contact your local ABB representative.  |
|            | 000A                       | (Asynchronous motors only)<br>Deceleration did not finish within reasonable time.           | Contact your local ABB representative.  |
|            | 000B                       | (Asynchronous motors only)<br>Speed dropped to zero during ID run.                          | Contact your local ABB representative.  |
|            | 000C                       | (Permanent magnet motors only)<br>First acceleration did not finish within reasonable time. | Contact your local ABB representative.  |

| <b>Code (hex)</b> | <b>Fault</b>    | <b>Cause</b>  | <b>What to do</b>  |
|-------------------|-----------------|---|--|
|                   | 000D            | (Permanent magnet motors only) Second acceleration did not finish within reasonable time. | Contact your local ABB representative.   |
|                   | 000E...0010     | Internal error.   | Contact your local ABB representative.   |
| FF7E              | Follower        | A follower drive has tripped.   | Check the auxiliary code. Add 2 to the code to find out the node address of the faulted drive.<br>Correct the fault in the follower drive. |
| FF81              | FB A force trip | A fault trip command has been received through fieldbus adapter A.                        | Check the fault information provided by the PLC.   |
| FF82              | FB B force trip | A fault trip command has been received through fieldbus adapter B.                        | Check the fault information provided by the PLC.   |
| FF8E              | EFB force trip  | A fault trip command has been received through the embedded fieldbus interface.           | Check the fault information provided by the Modbus controller.   |



# Fieldbus control through the embedded fieldbus interface (EFB)

---

## What this chapter contains

The chapter describes how the drive can be controlled by external devices over a communication network (fieldbus) using the embedded fieldbus interface.

## System overview

The drive can be connected to an external control system through a communication link using either a fieldbus adapter or the embedded fieldbus interface.

The embedded fieldbus interface supports the Modbus RTU protocol. The drive control program can handle 10 Modbus registers in a 10-millisecond time level. For example, if the drive receives a request to read 20 registers, it will start its response within 22 ms of receiving the request – 20 ms for processing the request and 2 ms overhead for handling the bus. The actual response time depends on other factors as well, such as the baud rate (a parameter setting in the drive).

The drive can be set to receive all of its control information through the fieldbus interface, or the control can be distributed between the embedded fieldbus interface and other available sources, for example, digital and analog inputs.

---

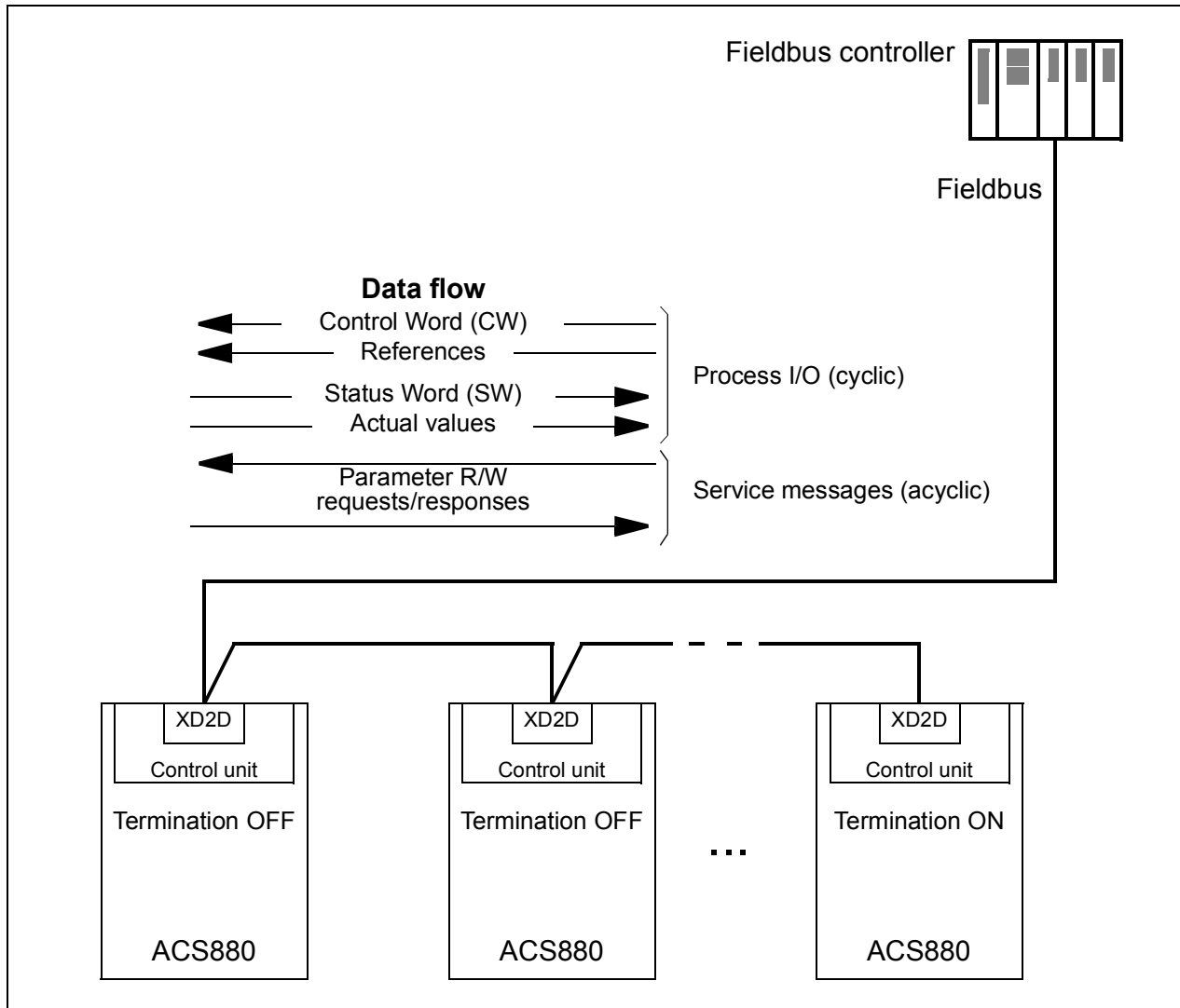

## Connecting the fieldbus to the drive

Connect the fieldbus to terminal XD2D on the control unit of the drive. See the appropriate *Hardware Manual* for more information on the connection, chaining and termination of the link.

**Note:** If the XD2D connector is reserved by the embedded fieldbus interface (parameter [58.01 Protocol enable](#) is set to [Modbus RTU](#)), the drive-to-drive link functionality is automatically disabled.



## Setting up the embedded fieldbus interface

Set the drive up for the embedded fieldbus communication with the parameters shown in the table below. The **Setting for fieldbus control** column gives either the value to use or the default value. The **Function/Information** column gives a description of the parameter.

| Parameter   | Setting for fieldbus control                                | Function/Information   |
|---|---|--|
| COMMUNICATION INITIALIZATION  |   |  |
| <a href="#">58.01</a> <i>Protocol enable</i>  | <i>Modbus RTU</i>   | Initializes embedded fieldbus communication. Drive-to-drive link operation is automatically disabled.  |
| EMBEDDED MODBUS CONFIGURATION   |   |  |
| <a href="#">58.03</a> <i>Node address</i>   | 1 (default)   | Node address. There must be no two nodes with the same node address online.  |
| <a href="#">58.04</a> <i>Baud rate</i>  | <i>19.2 kbps</i> (default)                                  | Defines the communication speed of the link. Use the same setting as in the master station.  |
| <a href="#">58.05</a> <i>Parity</i>   | <i>8 EVEN 1</i> (default)                                   | Selects the parity and stop bit setting. Use the same setting as in the master station.  |
| <a href="#">58.14</a> <i>Communication loss action</i>  | <i>Fault</i> (default)                                      | Defines the action taken when a communication loss is detected.  |
| <a href="#">58.15</a> <i>Communication loss mode</i>  | <i>Cw / Ref1 / Ref2</i> (default)                           | Enables/disables communication loss monitoring and defines the means for resetting the counter of the communication loss delay.                                      |
| <a href="#">58.16</a> <i>Communication loss time</i>  | 3.0 s (default)   | Defines the timeout limit for the communication monitoring.  |
| <a href="#">58.17</a> <i>Transmit delay</i>   | 0 ms (default)  | Defines a response delay for the drive.  |
| <a href="#">58.25</a> <i>Control profile</i>  | <i>ABB Drives</i> (default),<br><i>Transparent</i>          | Selects the control profile used by the drive. See section <a href="#">Basics of the embedded fieldbus interface</a> (page 533).                                     |
| <a href="#">58.26</a> <i>EFB ref1 type</i><br>...<br><a href="#">58.29</a> <i>EFB act2 type</i> | <i>Auto, Transparent, General, Torque, Speed, Frequency</i> | Selects the reference and actual value types. With the <i>Auto</i> setting, the type is selected automatically according to the currently active drive control mode. |
| <a href="#">58.30</a> <i>EFB status word transparent source</i>                                 | <i>Other</i>  | Defines the source of status word when <a href="#">58.25 Control profile</a> = <i>Transparent</i> .  |
| <a href="#">58.31</a> <i>EFB act1 transparent source</i>  | <i>Other</i>  | Defines the source of actual value 1 when <a href="#">58.28 EFB act1 type</a> = <i>Transparent</i> or <i>General</i> .   |
| <a href="#">58.32</a> <i>EFB act2 transparent source</i>  | <i>Other</i>  | Defines the source of actual value 2 when <a href="#">58.29 EFB act2 type</a> = <i>Transparent</i> or <i>General</i> .   |

| Parameter  | Setting for fieldbus control  | Function/Information  |
|--|---|---|
| <a href="#">58.33 Addressing mode</a>  | eg. <a href="#">Mode 0</a> (default)  | Defines the mapping between parameters and holding registers in the 400001...465536 (100...65535) Modbus register range.  |
| <a href="#">58.34 Word order</a>   | <a href="#">LO-HI</a> (default)   | Defines the order of the data words in the Modbus message frame.  |
| <a href="#">58.101 Data I/O 1</a><br>...<br><a href="#">58.124 Data I/O 24</a> | For example, the default settings (I/Os 1...6 contain the control word, the status word, two references and two actual values)  | Define the address of the drive parameter which the Modbus master accesses when it reads from or writes to the register address corresponding to Modbus In/Out parameters. Select the parameters that you want to read or write through the Modbus I/O words.                             |
|  | <a href="#">RO/DIO control word</a> , <a href="#">AO1 data storage</a> , <a href="#">AO2 data storage</a> , <a href="#">Feedback data storage</a> , <a href="#">Setpoint data storage</a> | These settings write the incoming data into storage parameters <a href="#">10.99 RO/DIO control word</a> , <a href="#">13.91 AO1 data storage</a> , <a href="#">13.92 AO2 data storage</a> , <a href="#">40.91 Feedback data storage</a> or <a href="#">40.92 Setpoint data storage</a> . |
| <a href="#">58.06 Communication control</a>                                    | <a href="#">Refresh settings</a>  | Validates the settings of the configuration parameters.   |

The new settings will take effect when the drive is powered up the next time, or when they are validated by parameter [58.06 Communication control](#).

## Setting the drive control parameters

After the embedded fieldbus interface has been set up, check and adjust the drive control parameters listed in the table below. The **Setting for fieldbus control** column gives the value or values to use when the embedded fieldbus signal is the desired source or destination for that particular drive control signal. The **Function/Information** column gives a description of the parameter.

| Parameter                               | Setting for fieldbus control                         | Function/Information   |
|---|--|--|
| CONTROL COMMAND SOURCE SELECTION        |  |  |
| <a href="#">20.01 Ext1 commands</a>     | <a href="#">Embedded fieldbus</a>                    | Selects fieldbus as the source for the start and stop commands when EXT1 is selected as the active control location. |
| <a href="#">20.02 Ext2 commands</a>     | <a href="#">Embedded fieldbus</a>                    | Selects fieldbus as the source for the start and stop commands when EXT2 is selected as the active control location. |
| SPEED REFERENCE SELECTION               |  |  |
| <a href="#">22.11 Speed ref1 source</a> | <a href="#">EFB ref1</a> or <a href="#">EFB ref2</a> | Selects a reference received through the embedded fieldbus interface as speed reference 1.                           |

| Parameter   | Setting for fieldbus control                         | Function/Information  |
|---|--|---|
| <a href="#">22.12 Speed ref2 source</a>   | <a href="#">EFB ref1</a> or <a href="#">EFB ref2</a> | Selects a reference received through the embedded fieldbus interface as speed reference 2.                  |
| <b>TORQUE REFERENCE SELECTION</b>   |  |   |
| <a href="#">26.11 Torque ref1 source</a>  | <a href="#">EFB ref1</a> or <a href="#">EFB ref2</a> | Selects a reference received through the embedded fieldbus interface as torque reference 1.                 |
| <a href="#">26.12 Torque ref2 source</a>  | <a href="#">EFB ref1</a> or <a href="#">EFB ref2</a> | Selects a reference received through the embedded fieldbus interface as torque reference 2.                 |
| <b>FREQUENCY REFERENCE SELECTION</b>  |  |   |
| <a href="#">28.11 Frequency ref1 source</a>   | <a href="#">EFB ref1</a> or <a href="#">EFB ref2</a> | Selects a reference received through the embedded fieldbus interface as frequency reference 1.              |
| <a href="#">28.12 Frequency ref2 source</a>   | <a href="#">EFB ref1</a> or <a href="#">EFB ref2</a> | Selects a reference received through the embedded fieldbus interface as frequency reference 2.              |
| <b>OTHER SELECTIONS</b>   |  |   |
| EFB references can be selected as the source at virtually any signal selector parameter by selecting <a href="#">Other</a> , then either <a href="#">03.09 EFB reference 1</a> or <a href="#">03.10 EFB reference 2</a> . |  |   |
| <b>CONTROL OF RELAY OUTPUTS, ANALOG OUTPUTS AND DIGITAL INPUT/OUTPUTS</b>   |  |   |
| <a href="#">10.24 RO1 source</a>  | <a href="#">RO/DIO control word bit0</a>             | Connects bit 0 of storage parameter <a href="#">10.99 RO/DIO control word</a> to relay output RO1.          |
| <a href="#">10.27 RO2 source</a>  | <a href="#">RO/DIO control word bit1</a>             | Connects bit 1 of storage parameter <a href="#">10.99 RO/DIO control word</a> to relay output RO2.          |
| <a href="#">10.30 RO3 source</a>  | <a href="#">RO/DIO control word bit2</a>             | Connects bit 2 of storage parameter <a href="#">10.99 RO/DIO control word</a> to relay output RO3.          |
| <a href="#">11.05 DIO1 function</a><br><a href="#">11.09 DIO2 function</a>  | <a href="#">Output</a> (default)                     | Sets the digital input/output to output mode.   |
| <a href="#">11.06 DIO1 output source</a>  | <a href="#">RO/DIO control word bit8</a>             | Connects bit 8 of storage parameter <a href="#">10.99 RO/DIO control word</a> to digital input/output DIO1. |
| <a href="#">11.10 DIO2 output source</a>  | <a href="#">RO/DIO control word bit9</a>             | Connects bit 9 of storage parameter <a href="#">10.99 RO/DIO control word</a> to digital input/output DIO2. |
| <a href="#">13.12 AO1 source</a>  | <a href="#">AO1 data storage</a>                     | Connects storage parameter <a href="#">13.91 AO1 data storage</a> to analog output AO1.                     |
| <a href="#">13.22 AO2 source</a>  | <a href="#">AO2 data storage</a>                     | Connects storage parameter <a href="#">13.92 AO2 data storage</a> to analog output AO2.                     |

532 *Fieldbus control through the embedded fieldbus interface (EFB)*

| Parameter                            | Setting for fieldbus control          | Function/Information  |
|--------------------------------------|---------------------------------------|---|
| PROCESS PID FEEDBACK AND SETPOINT    |                                       |   |
| <i>40.08 Set 1 feedback 1 source</i> | <i>Feedback data storage</i>          | Connect the bits of the storage parameter ( <i>10.99 RO/DIO control word</i> ) to the digital input/outputs of the drive. |
| <i>40.16 Set 1 setpoint 1 source</i> | <i>Setpoint data storage</i>          |   |
| SYSTEM CONTROL INPUTS                |                                       |   |
| <i>96.07 Parameter save manually</i> | <i>Save</i> (reverts to <i>Done</i> ) | Saves parameter value changes (including those made through fieldbus control) to permanent memory.                        |

## Basics of the embedded fieldbus interface

The cyclic communication between a fieldbus system and the drive consists of 16-bit data words or 32-bit data words (with the transparent control profiles).

The diagram below illustrates the operation of the embedded fieldbus interface. The signals transferred in the cyclic communication are explained further below the diagram.

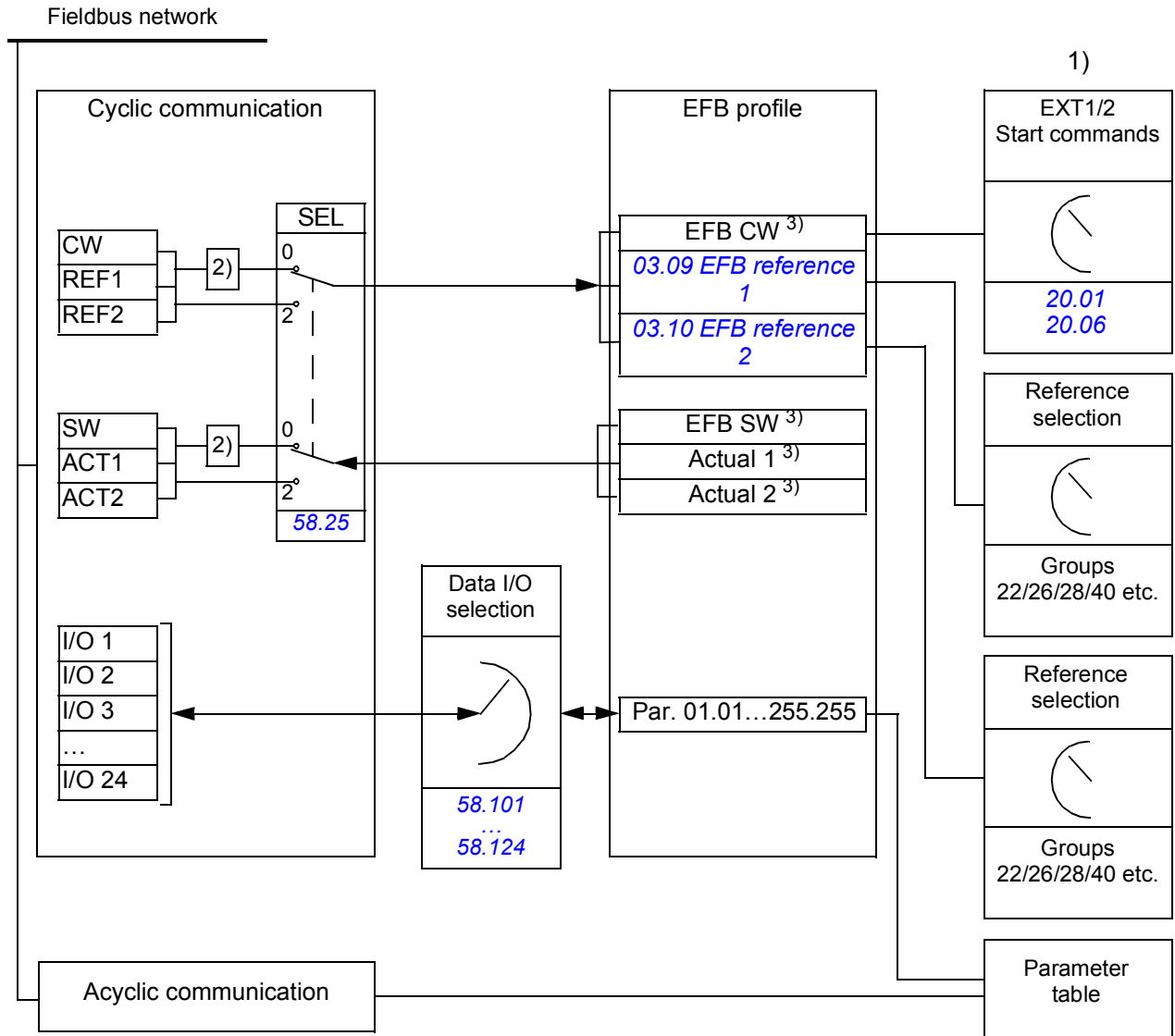

1. See also other parameters which can be controlled through fieldbus.
2. Data conversion if parameter [58.25 Control profile](#) is set to *ABB Drives*. See section [About the control profiles](#) (page 536).
3. If parameter [58.25 Control profile](#) is set to *Transparent*,
  - the sources of the status word and actual values are selected by parameters [58.30...58.32](#) (otherwise, actual values 1 and 2 are automatically selected according to reference type), and
  - the control word is displayed by [06.05 EFB transparent control word](#).

## ■ **Control word and Status word**

The Control Word (CW) is a 16-bit or 32-bit packed boolean word. It is the principal means of controlling the drive from a fieldbus system. The CW is sent by the fieldbus controller to the drive. By drive parameters, the user selects the EFB CW as the source of drive control commands (such as start/stop, emergency stop, selection between external control locations 1/2, or fault reset). The drive switches between its states according to the bit-coded instructions of the CW.

The fieldbus CW is either written to the drive as it is (see parameter [06.05 EFB transparent control word](#)), or the data is converted. See section [About the control profiles](#) (page 536).

The fieldbus Status Word (SW) is a 16-bit or 32-bit packed boolean word. It contains status information from the drive to the fieldbus controller. The drive SW is either written to the fieldbus SW as it is or the data is converted. See section [About the control profiles](#) (page 536).

## ■ **References**

EFB references 1 and 2 are 16-bit or 32-bit signed integers. The contents of each reference word can be used as the source of virtually any signal, such as the speed, frequency, torque or process reference. In embedded fieldbus communication, references 1 and 2 are displayed by [03.09 EFB reference 1](#) and [03.10 EFB reference 2](#) respectively. Whether the references are scaled or not depends on the settings of [58.26 EFB ref1 type](#) and [58.27 EFB ref2 type](#). See section [About the control profiles](#) (page 536).

## ■ **Actual values**

Fieldbus actual signals (ACT1 and ACT2) are 16-bit or 32-bit signed integers. They convey selected drive parameter values from the drive to the master. Whether the actual values are scaled or not depends on the settings of [58.28 EFB act1 type](#) and [58.29 EFB act2 type](#). See section [About the control profiles](#) (page 536).

## ■ **Data input/outputs**

Data input/outputs are 16-bit or 32-bit words containing selected drive parameter values. Parameters [58.101 Data I/O 1](#) ... [58.124 Data I/O 24](#) define the addresses from which the master either reads data (input) or to which it writes data (output).

## **Control of drive outputs through EFB**

The address selection parameters of the data input/outputs have a setting with which the data can be written into a storage parameter in the drive. These storage parameters are readily selectable as signal sources of the drive outputs.

The desired values of the relay outputs (RO) and digital input/outputs (DIO) can be written in a 16-bit word into [10.99 RO/DIO control word](#), which is then selected as the source of those outputs. Each of the analog outputs (AO) of the drive have a

---

dedicated storage parameter ([13.91 AO1 data storage](#) and [13.92 AO2 data storage](#)), which are available in the source selection parameters [13.12 AO1 source](#) and [13.22 AO2 source](#).

### **Sending process PID feedback and setpoint values through EFB**

The drive also has storage parameters for incoming process PID feedback ([40.91 Feedback data storage](#)) as well as a process PID setpoint ([40.92 Setpoint data storage](#)). The feedback storage parameter is selectable in the source selection parameters [40.08 Set 1 feedback 1 source](#) and [40.09 Set 1 feedback 2 source](#).

The corresponding parameters in process PID control set 2 (group [41 Process PID set 2](#)) have the same selections.

### **■ Register addressing**

The address field of Modbus requests for accessing holding registers is 16 bits. This allows the Modbus protocol to support addressing of 65536 holding registers.

Historically, Modbus master devices used 5-digit decimal addresses from 40001 to 49999 to represent holding register addresses. The 5-digit decimal addressing limited to 9999 the number of holding registers that could be addressed.

Modern Modbus master devices typically provide a means to access the full range of 65536 Modbus holding registers. One of these methods is to use 6-digit decimal addresses from 400001 to 465536. This manual uses 6-digit decimal addressing to represent Modbus holding register addresses.

Modbus master devices that are limited to the 5-digit decimal addressing may still access registers 400001 to 409999 by using 5-digit decimal addresses 40001 to 49999. Registers 410000 to 465536 are inaccessible to these masters.

**Note:** Register addresses of 32-bit parameters cannot be accessed by using 5-digit register numbers.

---

## About the control profiles

A control profile defines the rules for data transfer between the drive and the fieldbus master, for example:

- if packed boolean words are converted and how
- how drive register addresses are mapped for the fieldbus master.

You can configure the drive to receive and send messages according to the ABB Drives profile or the Transparent profile. With the ABB Drives profile, the embedded fieldbus interface of the drive converts the control word and status word to and from the native data used in the drive. The Transparent profile involves no data conversion. The figure below illustrates the effect of the profile selection.

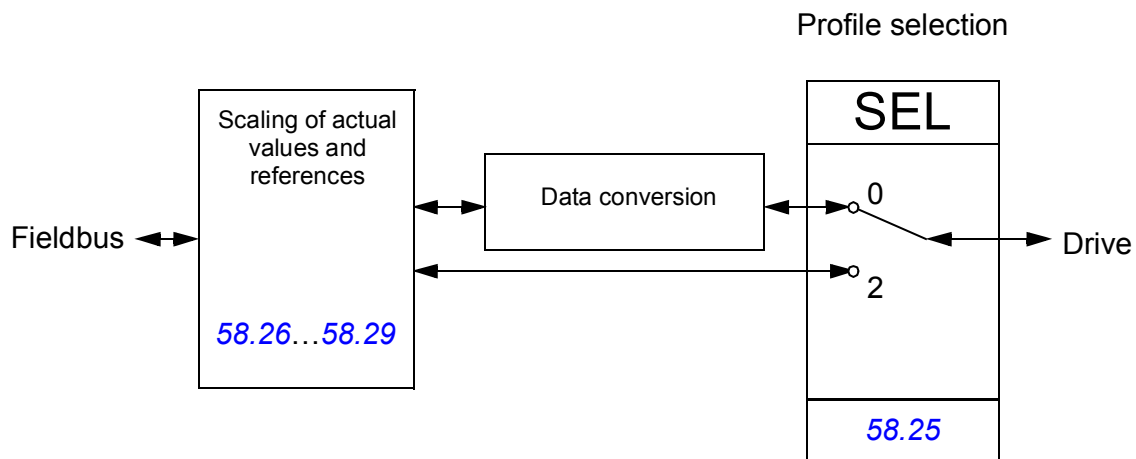

Control profile selection with parameter *58.25 Control profile*:

- (0) *ABB Drives*
- (2) *Transparent*

Note that scaling of references and actual values can be selected independent of the profile selection by parameters *58.26...58.29*.



## The ABB Drives profile

### ■ Control Word

The table below shows the contents of the fieldbus Control Word for the ABB Drives control profile. The embedded fieldbus interface converts this word to the form in which it is used in the drive. The upper case boldface text refers to the states shown in [State transition diagram](#) on page 540.

| Bit | Name                  | Value | STATE/Description   |
|-----|-----------------------|-------|---|
| 0   | OFF1_<br>CONTROL      | 1     | Proceed to READY TO OPERATE.  |
|     |                       | 0     | Stop along currently active deceleration ramp. Proceed to <b>OFF1 ACTIVE</b> ; proceed to <b>READY TO SWITCH ON</b> unless other interlocks (OFF2, OFF3) are active.  |
| 1   | OFF2_<br>CONTROL      | 1     | Continue operation (OFF2 inactive).   |
|     |                       | 0     | Emergency OFF, coast to stop. Proceed to <b>OFF2 ACTIVE</b> , proceed to <b>SWITCH-ON INHIBITED</b> .   |
| 2   | OFF3_<br>CONTROL      | 1     | Continue operation (OFF3 inactive).   |
|     |                       | 0     | Emergency stop, stop within time defined by drive parameter. Proceed to OFF3 ACTIVE; proceed to SWITCH-ON INHIBITED.<br><br>Warning: Ensure that the motor and driven machine can be stopped using this stop mode.          |
| 3   | INHIBIT_<br>OPERATION | 1     | Proceed to <b>OPERATION ENABLED</b> .<br><b>Note:</b> Run enable signal must be active; see the drive documentation. If the drive is set to receive the Run enable signal from the fieldbus, this bit activates the signal. |
|     |                       | 0     | Inhibit operation. Proceed to <b>OPERATION INHIBITED</b> .  |
| 4   | RAMP_OUT_<br>ZERO     | 1     | Normal operation. Proceed to <b>RAMP FUNCTION GENERATOR: OUTPUT ENABLED</b> .   |
|     |                       | 0     | Force Ramp Function Generator output to zero. Drive ramps to stop (current and DC voltage limits in force).   |
| 5   | RAMP_HOLD             | 1     | Enable ramp function.<br>Proceed to <b>RAMP FUNCTION GENERATOR: ACCELERATOR ENABLED</b> .   |
|     |                       | 0     | Halt ramping (Ramp Function Generator output held).   |
| 6   | RAMP_IN_<br>ZERO      | 1     | Normal operation. Proceed to <b>OPERATING</b> .<br><b>Note:</b> This bit is effective only if the fieldbus interface is set as the source for this signal by drive parameters.  |
|     |                       | 0     | Force Ramp Function Generator input to zero.  |
| 7   | RESET                 | 0=>1  | Fault reset if an active fault exists. Proceed to <b>SWITCH-ON INHIBITED</b> .<br><b>Note:</b> This bit is effective only if the fieldbus interface is set as the source for this signal by drive parameters.               |
|     |                       | 0     | Continue normal operation.  |

| Bit     | Name         | Value | STATE/Description   |
|---------|--------------|-------|---|
| 8       | JOGGING_1    | 1     | Accelerate to jogging 1 reference.<br><b>Notes:</b> <ul style="list-style-type: none"> <li>• Bits 4...6 must be 0.</li> <li>• See also section <i>Jogging</i> (page 55).</li> </ul> |
|         |              | 0     | Jogging 1 disabled.   |
| 9       | JOGGING_2    | 1     | Accelerate to jogging 2 reference.<br>See notes at bit 8.   |
|         |              | 0     | Jogging 2 disabled.   |
| 10      | REMOTE_CMD   | 1     | Fieldbus control enabled.   |
|         |              | 0     | Control word and reference will not get through to the drive, except for CW bits OFF1, OFF2 and OFF3.   |
| 11      | EXT_CTRL_LOC | 1     | Select External Control Location EXT2. Effective if the control location is parameterized to be selected from the fieldbus.   |
|         |              | 0     | Select External Control Location EXT1. Effective if the control location is parameterized to be selected from the fieldbus.   |
| 12...15 | Reserved     |       |   |

## ■ Status Word

The table below shows the fieldbus Status Word for the ABB Drives control profile. The embedded fieldbus interface converts the drive Status Word into this form for the fieldbus. The upper case boldface text refers to the states shown in [State transition diagram](#) on page 540.

| Bit     | Name           | Value | STATE/Description   |
|---------|----------------|-------|---|
| 0       | RDY_ON         | 1     | READY TO SWITCH ON.   |
|         |                | 0     | NOT READY TO SWITCH ON.   |
| 1       | RDY_RUN        | 1     | READY TO OPERATE.   |
|         |                | 0     | OFF1 ACTIVE.  |
| 2       | RDY_REF        | 1     | OPERATION ENABLED.  |
|         |                | 0     | OPERATION INHIBITED.  |
| 3       | TRIPPED        | 1     | FAULT.  |
|         |                | 0     | No fault.   |
| 4       | OFF_2_STA      | 1     | OFF2 inactive.  |
|         |                | 0     | OFF2 ACTIVE.  |
| 5       | OFF_3_STA      | 1     | OFF3 inactive.  |
|         |                | 0     | OFF3 ACTIVE.  |
| 6       | SWC_ON_INHIB   | 1     | SWITCH-ON INHIBITED.  |
|         |                | 0     | –   |
| 7       | ALARM          | 1     | Warning/Alarm.  |
|         |                | 0     | No warning/alarm.   |
| 8       | AT_SETPOINT    | 1     | OPERATING. Actual value equals Reference = is within tolerance limits, i.e. in speed control, speed error is 10% max. of nominal motor speed. |
|         |                | 0     | Actual value differs from Reference = is outside tolerance limits.  |
| 9       | REMOTE         | 1     | Drive control location: REMOTE (EXT1 or EXT2).  |
|         |                | 0     | Drive control location: LOCAL.  |
| 10      | ABOVE_LIMIT    | 1     | Actual frequency or speed equals or exceeds supervision limit (set by drive parameter). Valid in both directions of rotation.                 |
|         |                | 0     | Actual frequency or speed within supervision limit.   |
| 11      | USER_0         |       | S   |
| 12      | EXT_RUN_ENABLE | 1     | External Run enable signal received.  |
|         |                | 0     | No external Run enable signal received.   |
| 13...15 | Reserved       |       |   |

## State transition diagram

The diagram below shows the state transitions in the drive when the drive is using the ABB Drives profile, and configured to follow the commands of the control word from the embedded fieldbus interface. The upper case texts refer to the states which are used in the tables representing the fieldbus Control and Status words. See sections [Control Word](#) on page 537 and [Status Word](#) on page 539.

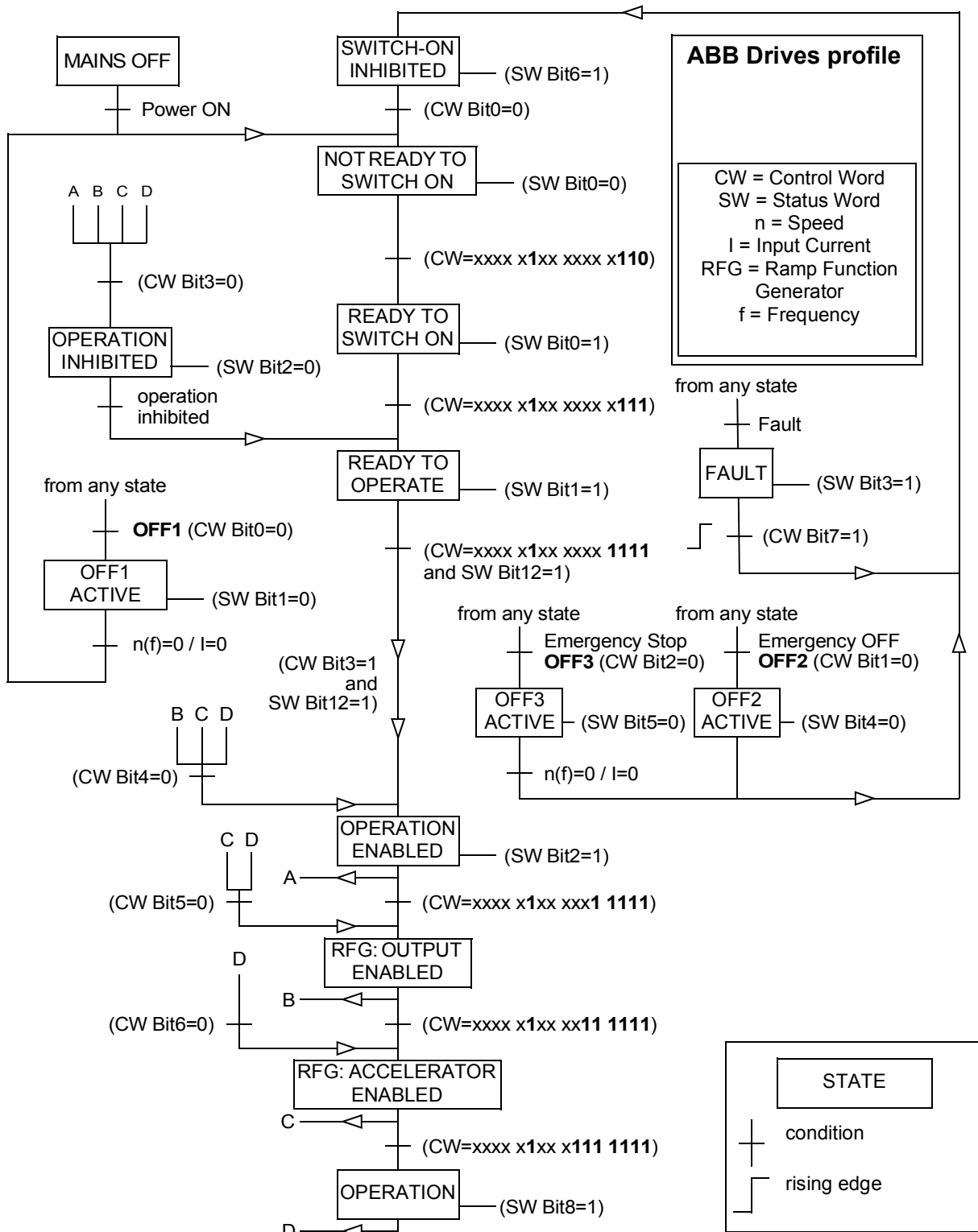

## ■ References

The ABB drives profile supports the use of two references, EFB reference 1 and EFB reference 2. The references are 16-bit words each containing a sign bit and a 15-bit integer. A negative reference is formed by calculating the two's complement from the corresponding positive reference.

The references are scaled as defined by parameters [46.01...46.07](#); which scaling is in use depends on the setting of [58.26 EFB ref1 type](#) and [58.27 EFB ref2 type](#) (see page [349](#)).

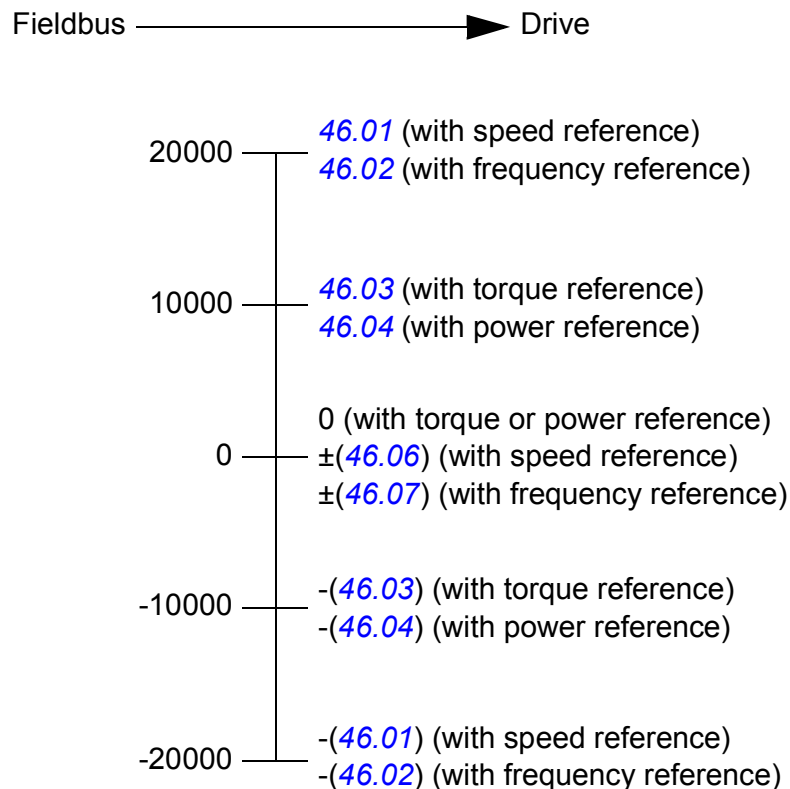

The scaled references are shown by parameters [03.09 EFB reference 1](#) and [03.10 EFB reference 2](#).

## ■ Actual values

The ABB Drives profile supports the use of two fieldbus actual values, ACT1 and ACT2. The actual values are 16-bit words each containing a sign bit and a 15-bit integer. A negative value is formed by calculating the two's complement from the corresponding positive value.

The actual values are scaled as defined by parameters [46.01...46.04](#); which scaling is in use depends on the setting of parameters [58.28 EFB act1 type](#) and [58.29 EFB act2 type](#) (see page [350](#)).

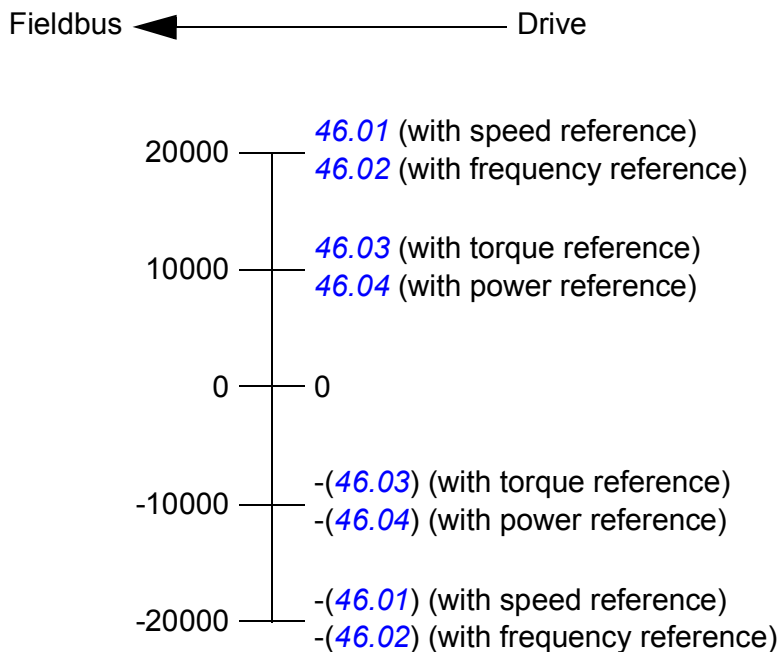

## ■ Modbus holding register addresses

The table below shows the default Modbus holding register addresses for drive data. This profile provides a converted 16-bit access to the data.

| Register address | Register data (16-bit words)  |
|------------------|---|
| 400001           | Control word. See section <a href="#">Control Word</a> (page 537).<br>The selection can be changed using parameter <a href="#">58.101 Data I/O 1</a> .    |
| 400002           | Reference 1 (REF1).<br>The selection can be changed using parameter <a href="#">58.102 Data I/O 2</a> .   |
| 400003           | Reference 2 (REF2).<br>The selection can be changed using parameter <a href="#">58.103 Data I/O 3</a> .   |
| 400004           | Status Word (SW). See section <a href="#">Status Word</a> (page 539).<br>The selection can be changed using parameter <a href="#">58.104 Data I/O 4</a> . |
| 400005           | Actual value 1 (ACT1).<br>The selection can be changed using parameter <a href="#">58.105 Data I/O 5</a> .  |
| 400006           | Actual value 2 (ACT2).<br>The selection can be changed using parameter <a href="#">58.106 Data I/O 6</a> .  |
| 400007...400024  | Data in/out 7...24.<br>Selected by parameters <a href="#">58.107 Data I/O 7</a> ... <a href="#">58.124 Data I/O 24</a> .                                  |
| 400025...400089  | Unused  |
| 400090...400100  | Error code access. See section <a href="#">Error code registers (holding registers 400090...400100)</a> (page 550).                                       |
| 400101...465536  | Parameter read/write.<br>Parameters are mapped to register addresses according to parameter <a href="#">58.33 Addressing mode</a> .                       |

## **The Transparent profile**

The Transparent profile enables a customizable access to the drive.

The contents of the control word are user-definable. The control word received from the fieldbus is visible in parameter [06.05 EFB transparent control word](#), and can be used to control the drive using pointer parameters and/or application programming.

The status word to be sent to the fieldbus controller is selected by parameter [58.30 EFB status word transparent source](#). This can be, for example, the user-configurable status word in [06.50 User status word 1](#).

The Transparent profile involves no data conversion of the control or status word. Whether references or actual values are scaled depends on the setting of parameters [58.26...58.29](#). The references received from the fieldbus are visible in parameters [03.09 EFB reference 1](#) and [03.10 EFB reference 2](#).

The Modbus holding register addresses for the Transparent profile are as with the ABB Drives profile (see page [543](#)).

---



## Modbus function codes

The table below shows the Modbus function codes supported by the embedded fieldbus interface.

| Code | Function name                 | Description  |
|------|-------------------------------|--|
| 01h  | Read Coils                    | Reads the 0/1 status of coils (0X references).   |
| 02h  | Read Discrete Inputs          | Reads the 0/1 status of discrete inputs (1X references).   |
| 03h  | Read Holding Registers        | Reads the binary contents of holding registers (4X references).  |
| 05h  | Write Single Coil             | Forces a single coil (0X reference) to 0 or 1.   |
| 06h  | Write Single Register         | Writes a single holding register (4X reference).   |
| 08h  | Diagnostics                   | <p>Provides a series of tests for checking the communication, or for checking various internal error conditions.</p> <p>Supported subcodes:</p> <ul style="list-style-type: none"> <li>• 00h Return Query Data: Echo/loopback test.</li> <li>• 01h Restart Comm Option: Restarts and initializes the EFB, clears communications event counters.</li> <li>• 04h Force Listen Only Mode</li> <li>• 0Ah Clear Counters and Diagnostic Register</li> <li>• 0Bh Return Bus Message Count</li> <li>• 0Ch Return Bus Comm. Error Count</li> <li>• 0Dh Return Bus Exception Error Count</li> <li>• 0Eh Return Slave Message Count</li> <li>• 0Fh Return Slave No Response Count</li> <li>• 10h Return Slave NAK (negative acknowledge) Count</li> <li>• 11h Return Slave Busy Count</li> <li>• 12h Return Bus Character Overrun Count</li> <li>• 14h Clear Overrun Counter and Flag</li> </ul> |
| 0Bh  | Get Comm Event Counter        | Returns a status word and an event count.  |
| 0Fh  | Write Multiple Coils          | Forces a sequence of coils (0X references) to 0 or 1.  |
| 10h  | Write Multiple Registers      | Writes the contents of a contiguous block of holding registers (4X references).  |
| 16h  | Mask Write Register           | Modifies the contents of a 4X register using a combination of an AND mask, an OR mask, and the register's current contents.  |
| 17h  | Read/Write Multiple Registers | Writes the contents of a contiguous block of 4X registers, then reads the contents of another group of registers (the same or different than those written) in a server device.  |

| Code      | Function name                    | Description   |
|-----------|----------------------------------|---|
| 2Bh / 0Eh | Encapsulated Interface Transport | <p>Supported subcodes:</p> <ul style="list-style-type: none"> <li>• 0Eh Read Device Identification: Allows reading the identification and other information.</li> </ul> <p>Supported ID codes (access type):</p> <ul style="list-style-type: none"> <li>• 00h: Request to get the basic device identification (stream access)</li> <li>• 04h: Request to get one specific identification object (individual access)</li> </ul> <p>Supported Object IDs:</p> <ul style="list-style-type: none"> <li>• 00h: Vendor Name (“ABB”)</li> <li>• 01h: Product Code (for example, “AINFX”)</li> <li>• 02h: Major Minor Revision (combination of contents of parameters <a href="#">07.05 Firmware version</a> and <a href="#">58.02 Protocol ID</a>).</li> <li>• 03h: Vendor URL (“www.abb.com”)</li> <li>• 04h: Product name (for example, “ACS880”)</li> </ul> |

## Exception codes

The table below shows the Modbus exception codes supported by the embedded fieldbus interface.

| Code | Name                 | Description  |
|------|----------------------|--|
| 01h  | ILLEGAL FUNCTION     | The function code received in the query is not an allowable action for the server.   |
| 02h  | ILLEGAL DATA ADDRESS | The data address received in the query is not an allowable address for the server.   |
| 03h  | ILLEGAL DATA VALUE   | <p>The requested Quantity of Registers is larger than the drive can handle.</p> <p><b>Note:</b> This error does not mean that a value written to a drive parameter is outside the valid range.</p> |
| 04h  | SLAVE DEVICE FAILURE | The value written to a drive parameter is outside the valid range. See section <a href="#">Error code registers (holding registers 400090...400100)</a> on page 550.                               |
| 06h  | SLAVE DEVICE BUSY    | The server is engaged in processing a long-duration program command.   |

## Coils (0xxxx reference set)

Coils are 1-bit read/write values. Control Word bits are exposed with this data type. The table below summarizes the Modbus coils (0xxxx reference set).

| Reference | ABB drives profile | Transparent profile                      |
|-----------|--------------------|--|
| 00001     | OFF1_CONTROL       | Control Word bit 0                       |
| 00002     | OFF2_CONTROL       | Control Word bit 1                       |
| 00003     | OFF3_CONTROL       | Control Word bit 2                       |
| 00004     | INHIBIT_OPERATION  | Control Word bit 3                       |
| 00005     | RAMP_OUT_ZERO      | Control Word bit 4                       |
| 00006     | RAMP_HOLD          | Control Word bit 5                       |
| 00007     | RAMP_IN_ZERO       | Control Word bit 6                       |
| 00008     | RESET              | Control Word bit 7                       |
| 00009     | JOGGING_1          | Control Word bit 8                       |
| 00010     | JOGGING_2          | Control Word bit 9                       |
| 00011     | REMOTE_CMD         | Control Word bit 10                      |
| 00012     | EXT_CTRL_LOC       | Control Word bit 11                      |
| 00013     | User-defined (0)   | Control Word bit 12                      |
| 00014     | User-defined (1)   | Control Word bit 13                      |
| 00015     | User-defined (2)   | Control Word bit 14                      |
| 00016     | User-defined (3)   | Control Word bit 15                      |
| 00017     | Reserved           | Control Word bit 16                      |
| 00018     | Reserved           | Control Word bit 17                      |
| 00019     | Reserved           | Control Word bit 18                      |
| 00020     | Reserved           | Control Word bit 19                      |
| 00021     | Reserved           | Control Word bit 20                      |
| 00022     | Reserved           | Control Word bit 21                      |
| 00023     | Reserved           | Control Word bit 22                      |
| 00024     | Reserved           | Control Word bit 23                      |
| 00025     | Reserved           | Control Word bit 24                      |
| 00026     | Reserved           | Control Word bit 25                      |
| 00027     | Reserved           | Control Word bit 26                      |
| 00028     | Reserved           | Control Word bit 27                      |
| 00029     | Reserved           | Control Word bit 28                      |
| 00030     | Reserved           | Control Word bit 29                      |
| 00031     | Reserved           | Control Word bit 30                      |
| 00032     | Reserved           | Control Word bit 31                      |
| 00033     | Reserved           | <i>10.99 RO/DIO control word</i> , bit 0 |
| 00034     | Reserved           | <i>10.99 RO/DIO control word</i> , bit 1 |

| Reference | ABB drives profile | Transparent profile                      |
|-----------|--------------------|--|
| 00035     | Reserved           | <i>10.99 RO/DIO control word</i> , bit 2 |
| 00036     | Reserved           | <i>10.99 RO/DIO control word</i> , bit 3 |
| 00037     | Reserved           | <i>10.99 RO/DIO control word</i> , bit 4 |
| 00038     | Reserved           | <i>10.99 RO/DIO control word</i> , bit 5 |
| 00039     | Reserved           | <i>10.99 RO/DIO control word</i> , bit 6 |
| 00040     | Reserved           | <i>10.99 RO/DIO control word</i> , bit 7 |
| 00041     | Reserved           | <i>10.99 RO/DIO control word</i> , bit 8 |
| 00042     | Reserved           | <i>10.99 RO/DIO control word</i> , bit 9 |

## Discrete inputs (1xxxx reference set)

Discrete inputs are 1-bit read-only values. Status Word bits are exposed with this data type. The table below summarizes the Modbus discrete inputs (1xxxx reference set).

| Reference | ABB drives profile | Transparent profile |
|-----------|--------------------|---------------------|
| 10001     | RDY_ON             | Status Word bit 0   |
| 10002     | RDY_RUN            | Status Word bit 1   |
| 10003     | RDY_REF            | Status Word bit 2   |
| 10004     | TRIPPED            | Status Word bit 3   |
| 10005     | OFF_2_STA          | Status Word bit 4   |
| 10006     | OFF_3_STA          | Status Word bit 5   |
| 10007     | SWC_ON_INHIB       | Status Word bit 6   |
| 10008     | ALARM              | Status Word bit 7   |
| 10009     | AT_SETPOINT        | Status Word bit 8   |
| 10010     | REMOTE             | Status Word bit 9   |
| 10011     | ABOVE_LIMIT        | Status Word bit 10  |
| 10012     | User-defined (0)   | Status Word bit 11  |
| 10013     | User-defined (1)   | Status Word bit 12  |
| 10014     | User-defined (2)   | Status Word bit 13  |
| 10015     | User-defined (3)   | Status Word bit 14  |
| 10016     | Reserved           | Status Word bit 15  |
| 10017     | Reserved           | Status Word bit 16  |
| 10018     | Reserved           | Status Word bit 17  |
| 10019     | Reserved           | Status Word bit 18  |
| 10020     | Reserved           | Status Word bit 19  |
| 10021     | Reserved           | Status Word bit 20  |
| 10022     | Reserved           | Status Word bit 21  |
| 10023     | Reserved           | Status Word bit 22  |
| 10024     | Reserved           | Status Word bit 23  |

| Reference | ABB drives profile | Transparent profile                     |
|-----------|--------------------|---|
| 10025     | Reserved           | Status Word bit 24                      |
| 10026     | Reserved           | Status Word bit 25                      |
| 10027     | Reserved           | Status Word bit 26                      |
| 10028     | Reserved           | Status Word bit 27                      |
| 10029     | Reserved           | Status Word bit 28                      |
| 10030     | Reserved           | Status Word bit 29                      |
| 10031     | Reserved           | Status Word bit 30                      |
| 10032     | Reserved           | Status Word bit 31                      |
| 10033     | Reserved           | <i>10.02 DI delayed status</i> , bit 0  |
| 10034     | Reserved           | <i>10.02 DI delayed status</i> , bit 1  |
| 10035     | Reserved           | <i>10.02 DI delayed status</i> , bit 2  |
| 10036     | Reserved           | <i>10.02 DI delayed status</i> , bit 3  |
| 10037     | Reserved           | <i>10.02 DI delayed status</i> , bit 4  |
| 10038     | Reserved           | <i>10.02 DI delayed status</i> , bit 5  |
| 10039     | Reserved           | <i>10.02 DI delayed status</i> , bit 6  |
| 10040     | Reserved           | <i>10.02 DI delayed status</i> , bit 7  |
| 10041     | Reserved           | <i>10.02 DI delayed status</i> , bit 8  |
| 10042     | Reserved           | <i>10.02 DI delayed status</i> , bit 9  |
| 10043     | Reserved           | <i>10.02 DI delayed status</i> , bit 10 |
| 10044     | Reserved           | <i>10.02 DI delayed status</i> , bit 11 |
| 10045     | Reserved           | <i>10.02 DI delayed status</i> , bit 12 |
| 10046     | Reserved           | <i>10.02 DI delayed status</i> , bit 13 |
| 10047     | Reserved           | <i>10.02 DI delayed status</i> , bit 14 |
| 10048     | Reserved           | <i>10.02 DI delayed status</i> , bit 15 |

**Error code registers (holding registers 400090...400100)**

These registers contain information about the last query. The error register is cleared when a query has finished successfully.

| Reference | Name                               | Description  |
|-----------|------------------------------------|--|
| 89        | Reset Error Registers              | 1 = Reset internal error registers (91...95).  |
| 90        | Error Function Code                | Function code of the failed query.   |
| 91        | Error Code                         | Set when exception code 04h is generated (see table above). <ul style="list-style-type: none"> <li>• 00h No error</li> <li>• 02h Low/High limit exceeded</li> <li>• 03h Faulty Index: Unavailable index of an array parameter</li> <li>• 05h Incorrect Data Type: Value does not match the data type of the parameter</li> <li>• 65h General Error: Undefined error when handling query</li> </ul> |
| 92        | Failed Register                    | The last register (discrete input, coil, or holding register) that failed to be read or written.   |
| 93        | Last Register Written Successfully | The last register that was written successfully.   |
| 94        | Last Register Read Successfully    | The last register that was read successfully.  |

# 10

## Fieldbus control through a fieldbus adapter

---

### What this chapter contains

This chapter describes how the drive can be controlled by external devices over a communication network (fieldbus) through an optional fieldbus adapter module.

The fieldbus control interface of the drive is described first, followed by a configuration example.

### System overview

The drive can be connected to an external control system through an optional fieldbus adapter mounted onto the control unit of the drive. The drive actually has two independent interfaces for fieldbus connection, called “fieldbus adapter A” (FBA A) and “fieldbus adapter B” (FBA B). The drive can be configured to receive all of its control information through the fieldbus interface(s), or the control can be distributed between the fieldbus interface(s) and other available sources such as digital and analog inputs, depending on how control locations EXT1 and EXT2 are configured.

**Note:** The text and examples in this chapter describe the configuration of one fieldbus adapter (FBA A) by parameters [50.01](#)...[50.21](#) and parameter groups 51...53. The second adapter (FBA B), if present, is configured in a similar fashion by parameters [50.31](#)...[50.51](#) and parameter groups 54...56. It is recommended that the FBA B interface is only used for monitoring.

---

Fieldbus adapters are available for various communication systems and protocols, for example

- CANopen (FCAN-01 adapter)
- ControlNet (FCNA-01 adapter)
- DeviceNet (FDNA-01 adapter)
- EtherCAT® (FECA-01 adapter)
- EtherNet/IP™ (FENA-11 or FENA-21 adapter)
- Modbus/RTU (FSCA-01 adapter)
- Modbus/TCP (FENA-11 or FENA-21 adapter)
- POWERLINK (FEPL-02 adapter)
- PROFIBUS DP (FPBA-01 adapter)
- PROFINET IO (FENA-11 or FENA-21 adapter).

**Note:** Fieldbus adapters with the suffix “M” (eg. FPBA-01-M) are not supported.

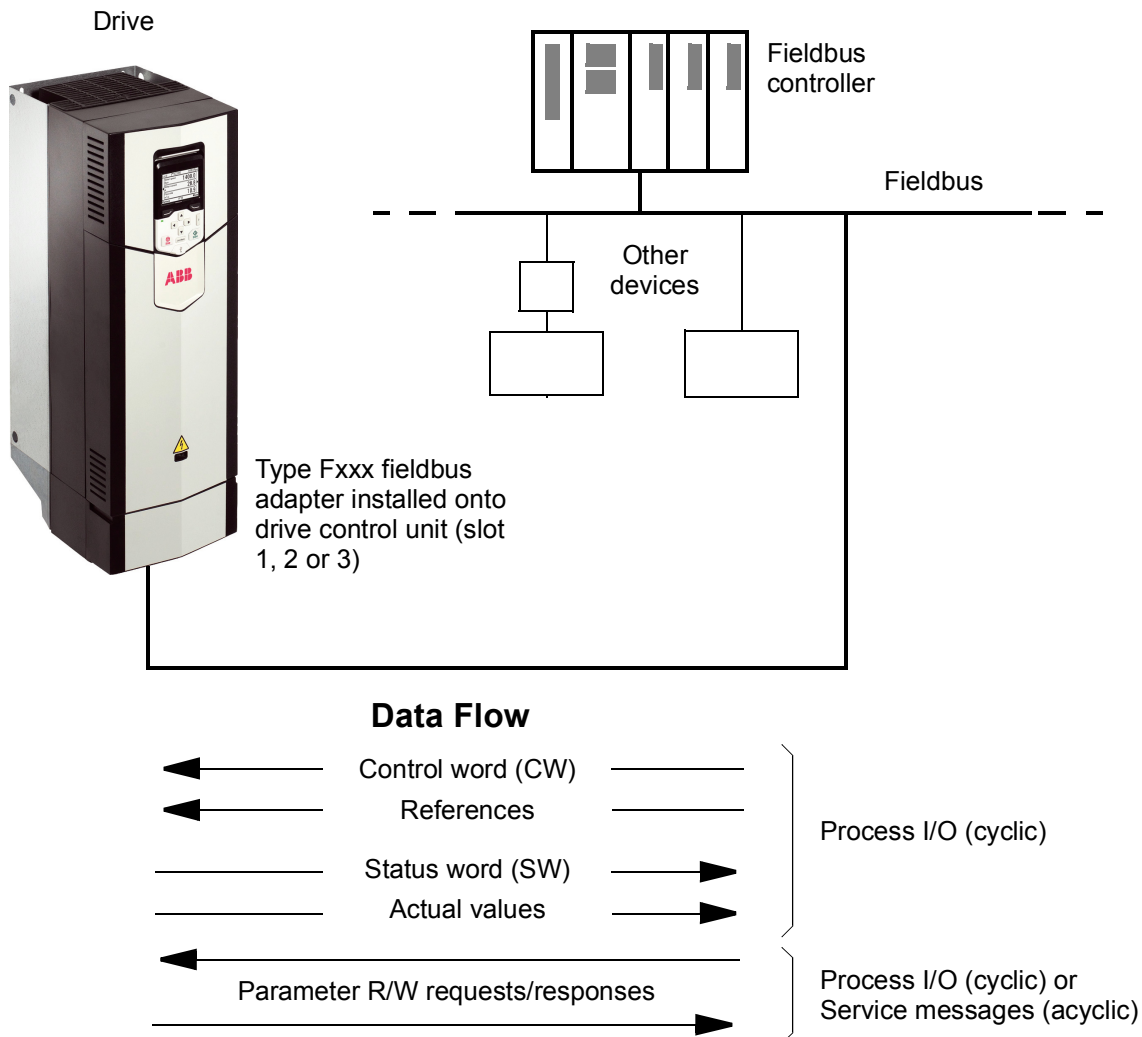



## Basics of the fieldbus control interface

The cyclic communication between a fieldbus system and the drive consists of 16- or 32-bit input and output data words. The drive is able to support a maximum of 12 data words (16 bits) in each direction.

Data transmitted from the drive to the fieldbus controller is defined by parameters [52.01 FBA A data in1](#) ... [52.12 FBA A data in12](#). The data transmitted from the fieldbus controller to the drive is defined by parameters [53.01 FBA A data out1](#) ... [53.12 FBA A data out12](#).

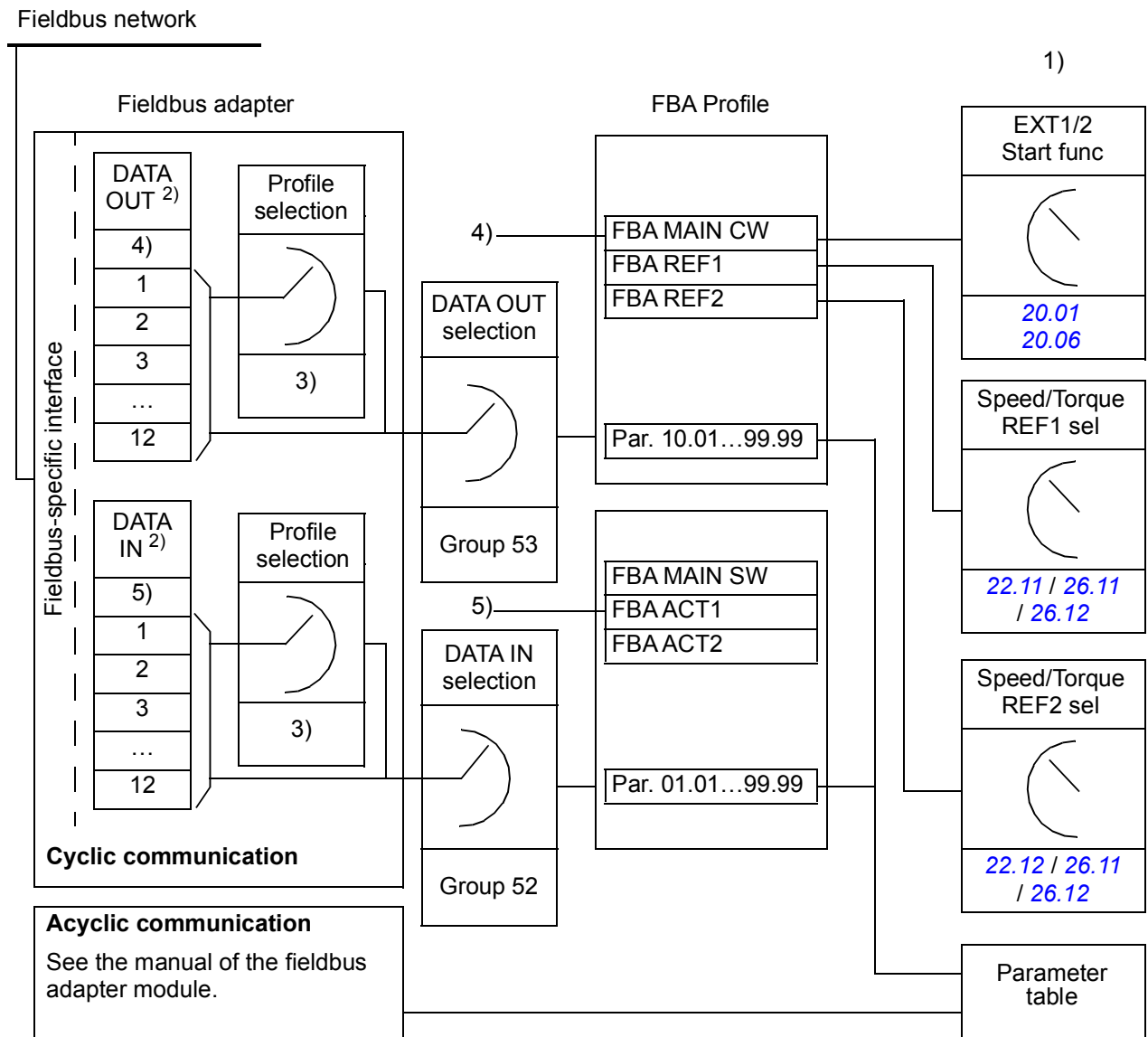

- 1) See also other parameters which can be controlled from fieldbus.
- 2) The maximum number of data words used is protocol-dependent.
- 3) Profile/instance selection parameters. Fieldbus module specific parameters. For more information, see the *User's Manual* of the appropriate fieldbus adapter module.
- 4) With DeviceNet, the control part is transmitted directly.
- 5) With DeviceNet, the actual value part is transmitted directly.

## ■ Control word and Status word

The Control word is the principal means for controlling the drive from a fieldbus system. It is sent by the fieldbus master station to the drive through the adapter module. The drive switches between its states according to the bit-coded instructions in the Control word, and returns status information to the master in the Status word.

For the ABB Drives communication profile, the contents of the Control word and the Status word are detailed on pages [557](#) and [558](#) respectively. The drive states are presented in the state diagram (page [559](#)).

When a transparent communication profile is selected eg. by parameter group [51 FBA A settings](#), the control word received from the PLC is available in [06.03 FBA A transparent control word](#). The individual bits of the word can then be used for drive control through bit pointer parameters. The source of the status word, for example [06.50 User status word 1](#), can be selected in [50.09 FBA A SW transparent source](#).

## Debugging the network words

If parameter [50.12 FBA A debug mode](#) is set to *Fast*, the Control word received from the fieldbus is shown by parameter [50.13 FBA A control word](#), and the Status word transmitted to the fieldbus network by [50.16 FBA A status word](#). This “raw” data is very useful to determine if the fieldbus master is transmitting the correct data before handing control to the fieldbus network.

## ■ References

References are 16-bit words containing a sign bit and a 15-bit integer. A negative reference (indicating reversed direction of rotation) is formed by calculating the two's complement from the corresponding positive reference.

ABB drives can receive control information from multiple sources including analog and digital inputs, the drive control panel and a fieldbus adapter module. In order to have the drive controlled through the fieldbus, the module must be defined as the source for control information such as reference. This is done using the source selection parameters in groups [22 Speed reference selection](#), [26 Torque reference chain](#) and [28 Frequency reference chain](#).

## Debugging the network words

If parameter [50.12 FBA A debug mode](#) is set to *Fast*, the references received from the fieldbus are displayed by [50.14 FBA A reference 1](#) and [50.15 FBA A reference 2](#).

## Scaling of references

**Note:** The scalings described below are for the ABB Drives communication profile. Fieldbus-specific communication profiles may use different scalings. For more information, see the manual of the fieldbus adapter.

---

The references are scaled as defined by parameters [46.01...46.07](#); which scaling is in use depends on the setting of [50.04 FBA A ref1 type](#) and [50.05 FBA A ref2 type](#).

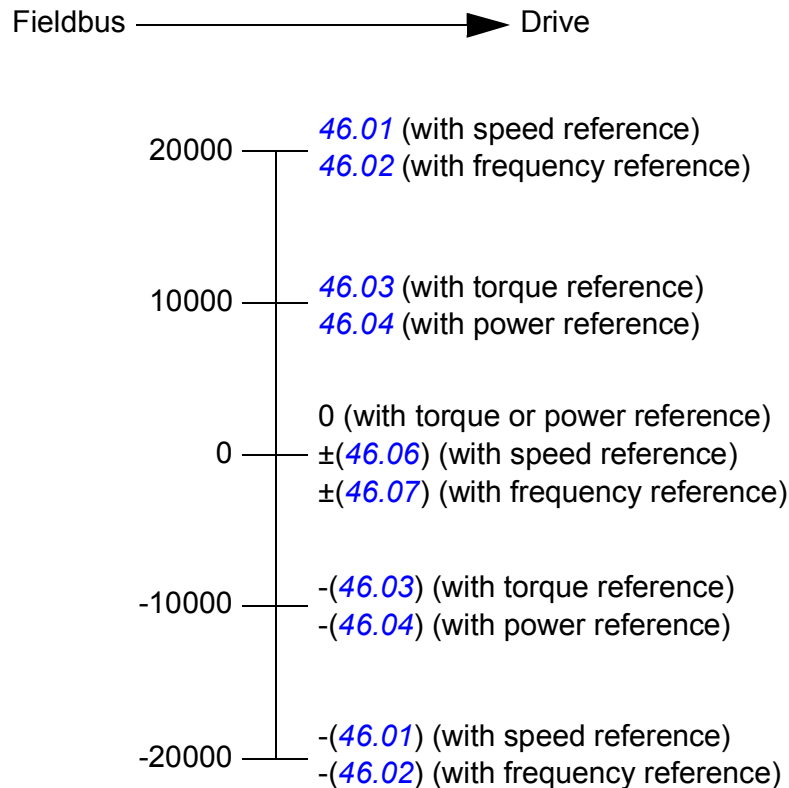

The scaled references are shown by parameters [03.05 FB A reference 1](#) and [03.06 FB A reference 2](#).

### ■ Actual values

Actual values are 16-bit words containing information on the operation of the drive. The types of the monitored signals are selected by parameters [50.07 FBA A actual 1 type](#) and [50.08 FBA A actual 2 type](#).

### Debugging the network words

If parameter [50.12 FBA A debug mode](#) is set to *Fast*, the actual values sent to the fieldbus are displayed by [50.17 FBA A actual value 1](#) and [50.18 FBA A actual value 2](#).

### Scaling of actual values

**Note:** The scalings described below are for the ABB Drives communication profile. Fieldbus-specific communication profiles may use different scalings. For more information, see the manual of the fieldbus adapter.

The actual values are scaled as defined by parameters [46.01...46.04](#); which scaling is in use depends on the setting of parameters [50.07 FBA A actual 1 type](#) and [50.08 FBA A actual 2 type](#).

Fieldbus ←———— Drive

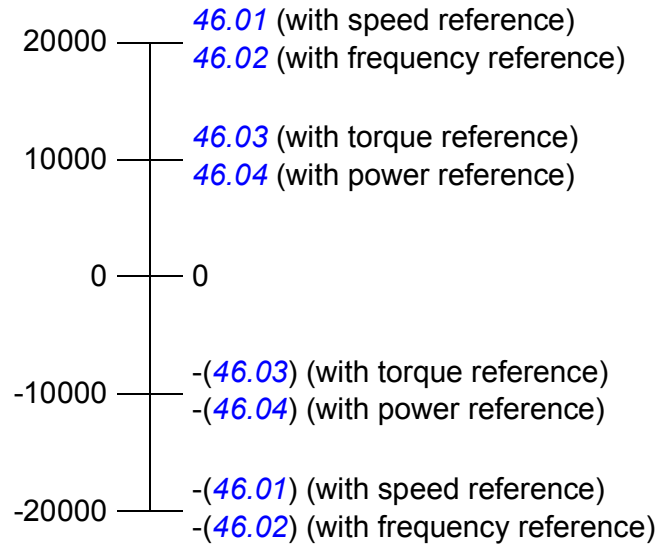

## ■ Contents of the fieldbus Control word (ABB Drives profile)

The upper case boldface text refers to the states shown in the state diagram (page 559).

| Bit      | Name          | Value | STATE/Description  |
|----------|---------------|-------|--|
| 0        | Off1 control  | 1     | Proceed to <b>READY TO OPERATE</b> .   |
|          |               | 0     | Stop along currently active deceleration ramp. Proceed to <b>OFF1 ACTIVE</b> ; proceed to <b>READY TO SWITCH ON</b> unless other interlocks (OFF2, OFF3) are active.   |
| 1        | Off2 control  | 1     | Continue operation (OFF2 inactive).  |
|          |               | 0     | Emergency OFF, coast to a stop. Proceed to <b>OFF2 ACTIVE</b> , proceed to <b>SWITCH-ON INHIBITED</b> .  |
| 2        | Off3 control  | 1     | Continue operation (OFF3 inactive).  |
|          |               | 0     | Emergency stop, stop within time defined by drive parameter. Proceed to <b>OFF3 ACTIVE</b> ; proceed to <b>SWITCH-ON INHIBITED</b> .<br> <b>WARNING:</b> Ensure motor and driven machine can be stopped using this stop mode.             |
| 3        | Run           | 1     | Proceed to <b>OPERATION ENABLED</b> .<br><b>Note:</b> Run enable signal must be active. If the drive is set to receive the Run enable signal from the fieldbus, this bit activates the signal. See also parameters <a href="#">06.18 Start inhibit status word</a> and <a href="#">06.25 Drive inhibit status word 2</a> . |
|          |               | 0     | Inhibit operation. Proceed to <b>OPERATION INHIBITED</b> .   |
| 4        | Ramp out zero | 1     | Normal operation. Proceed to <b>RAMP FUNCTION GENERATOR: OUTPUT ENABLED</b> .  |
|          |               | 0     | Force Ramp function generator output to zero. The drive will immediately decelerate to zero speed (observing the torque limits).   |
| 5        | Ramp hold     | 1     | Enable ramp function. Proceed to <b>RAMP FUNCTION GENERATOR: ACCELERATOR ENABLED</b> .   |
|          |               | 0     | Halt ramping (Ramp Function Generator output held).  |
| 6        | Ramp in zero  | 1     | Normal operation. Proceed to <b>OPERATING</b> .<br><b>Note:</b> This bit is effective only if the fieldbus interface is set as the source for this signal by drive parameters.   |
|          |               | 0     | Force Ramp function generator input to zero.   |
| 7        | Reset         | 0=>1  | Fault reset if an active fault exists. Proceed to <b>SWITCH-ON INHIBITED</b> .<br><b>Note:</b> This bit is effective only if the fieldbus interface is set as the source of the reset signal by drive parameters.  |
|          |               | 0     | Continue normal operation.   |
| 8        | Inching 1     | 1     | Accelerate to inching (jogging) setpoint 1.<br><b>Notes:</b><br>• Bits 4...6 must be 0.<br>• See also section <a href="#">Jogging</a> (page 55).   |
|          |               | 0     | Inching (jogging) 1 disabled.  |
| 9        | Inching 2     | 1     | Accelerate to inching (jogging) setpoint 2. See notes at bit 8.  |
|          |               | 0     | Inching (jogging) 2 disabled.  |
| 10       | Remote cmd    | 1     | Fieldbus control enabled.  |
|          |               | 0     | Control word and reference not getting through to the drive, except for bits 0...2.  |
| 11       | Ext ctrl loc  | 1     | Select External Control Location EXT2. Effective if control location is parameterized to be selected from fieldbus.  |
|          |               | 0     | Select External Control Location EXT1. Effective if control location is parameterized to be selected from fieldbus.  |
| 12 to 15 | Reserved.     |       |  |

## ■ Contents of the fieldbus Status word (ABB Drives profile)

The upper case boldface text refers to the states shown in the state diagram (page 559).

| Bit | Name                | Value | STATE/Description  |
|-----|---------------------|-------|--|
| 0   | Ready to switch ON  | 1     | <b>READY TO SWITCH ON.</b>   |
|     |                     | 0     | <b>NOT READY TO SWITCH ON.</b>   |
| 1   | Ready run           | 1     | <b>READY TO OPERATE.</b>   |
|     |                     | 0     | <b>OFF1 ACTIVE.</b>  |
| 2   | Ready ref           | 1     | <b>OPERATION ENABLED.</b>  |
|     |                     | 0     | <b>OPERATION INHIBITED.</b> See parameters <a href="#">06.18 Start inhibit status word</a> and <a href="#">06.25 Drive inhibit status word 2</a> for the inhibiting condition. |
| 3   | Tripped             | 1     | <b>FAULT.</b>  |
|     |                     | 0     | No fault.  |
| 4   | Off 2 inactive      | 1     | OFF2 inactive.   |
|     |                     | 0     | <b>OFF2 ACTIVE.</b>  |
| 5   | Off 3 inactive      | 1     | OFF3 inactive.   |
|     |                     | 0     | <b>OFF3 ACTIVE.</b>  |
| 6   | Switch-on inhibited | 1     | <b>SWITCH-ON INHIBITED.</b>  |
|     |                     | 0     | –  |
| 7   | Warning             | 1     | Warning active.  |
|     |                     | 0     | No warning active.   |
| 8   | At setpoint         | 1     | <b>OPERATING.</b> Actual value equals reference = is within tolerance limits (see parameters <a href="#">46.21...46.23</a> ).  |
|     |                     | 0     | Actual value differs from reference = is outside tolerance limits.   |
| 9   | Remote              | 1     | Drive control location: REMOTE (EXT1 or EXT2).   |
|     |                     | 0     | Drive control location: LOCAL.   |
| 10  | Above limit         | -     | See parameter <a href="#">06.29 MSW bit 10 sel.</a>  |
| 11  | User bit 0          | -     | See parameter <a href="#">06.30 MSW bit 11 sel.</a>  |
| 12  | User bit 1          | -     | See parameter <a href="#">06.31 MSW bit 12 sel.</a>  |
| 13  | User bit 2          | -     | See parameter <a href="#">06.32 MSW bit 13 sel.</a>  |
| 14  | User bit 3          | -     | See parameter <a href="#">06.33 MSW bit 14 sel.</a>  |
| 15  | Reserved            |       |  |

■ The state diagram (ABB Drives profile)

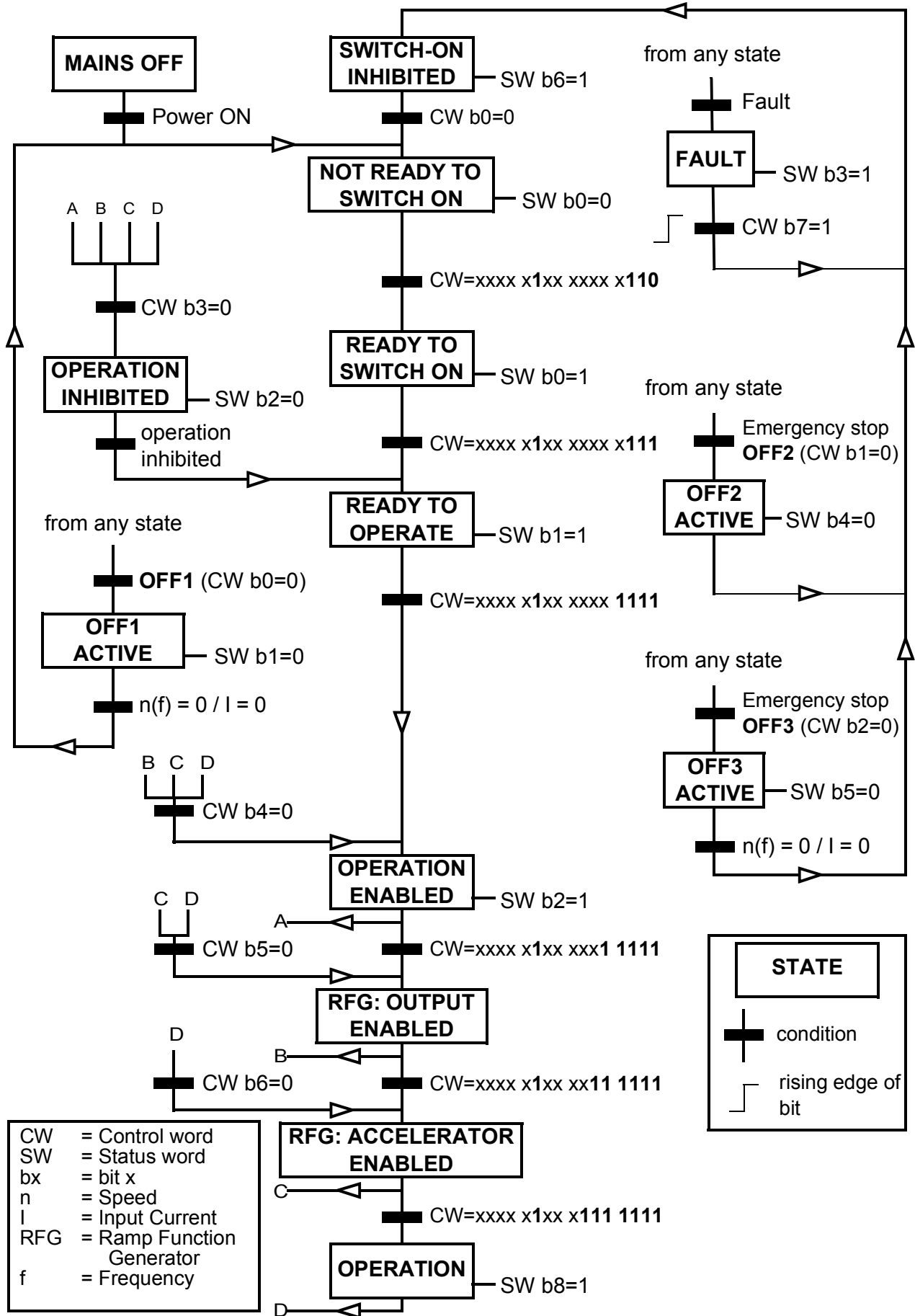

## Setting up the drive for fieldbus control

1. Install the fieldbus adapter module mechanically and electrically according to the instructions given in the *User's manual* of the module.
  2. Power up the drive.
  3. Enable the communication between the drive and the fieldbus adapter module with parameter [50.01 FBA A enable](#).
  4. With [50.02 FBA A comm loss func](#), select how the drive should react to a fieldbus communication break.  
**Note:** This function monitors both the communication between the fieldbus master and the adapter module and the communication between the adapter module and the drive.
  5. With [50.03 FBA A comm loss t out](#), define the time between communication break detection and the selected action.
  6. Select application-specific values for the rest of the parameters in group [50 Fieldbus adapter \(FBA\)](#), starting from [50.04](#). Examples of appropriate values are shown in the tables below.
  7. Set the fieldbus adapter module configuration parameters in group [51 FBA A settings](#). As a minimum, set the required node address and the control profile.
  8. Define the process data transferred to and from the drive in parameter groups [52 FBA A data in](#) and [53 FBA A data out](#).  
**Note:** Depending on the communication protocol and profile being used, the Control word and Status word may already be configured to be sent/received by the communication system.
  9. Save the valid parameter values to permanent memory by setting parameter [96.07 Parameter save manually](#) to [Save](#).
  10. Validate the settings made in parameter groups 51, 52 and 53 by setting parameter [51.27 FBA A par refresh](#) to [Refresh](#).
  11. Configure control locations EXT1 and EXT2 to allow control and reference signals to come from the fieldbus. Examples of appropriate values are shown in the tables below.
-



## ■ Parameter setting example: FPBA (PROFIBUS DP)

This example shows how to configure a basic speed control application that uses the PROFIdrive communication profile with PPO Type 2. The start/stop commands and reference are according to the PROFIdrive profile, speed control mode.

The reference values sent over the fieldbus have to be scaled within the drive so they have the desired effect. The reference value  $\pm 16384$  (4000h) corresponds to the range of speed set in parameter [46.01 Speed scaling](#) (both forward and reverse directions). For example, if [46.01](#) is set to 480 rpm, then 4000h sent over fieldbus will request 480 rpm.

| Direction | PZD1         | PZD2               | PZD3          | PZD4 | PZD5       | PZD6 |
|-----------|--------------|--------------------|---------------|------|------------|------|
| Out       | Control word | Speed reference    | Acc time 1    |      | Dec time 1 |      |
| In        | Status word  | Speed actual value | Motor current |      | DC voltage |      |

The table below gives the recommended drive parameter settings.

| Drive parameter                           | Setting for ACS880 drives  | Description   |
|---|----------------------------|---|
| <a href="#">50.01 FBA A enable</a>        | 1...3 = [slot number]      | Enables communication between the drive and the fieldbus adapter module.  |
| <a href="#">50.04 FBA A ref1 type</a>     | 4 = <i>Speed</i>           | Selects the fieldbus A reference 1 type and scaling.  |
| <a href="#">50.07 FBA A actual 1 type</a> | 0 = <i>Auto</i>            | Selects the actual value type/source and scaling according to the currently active control mode (as displayed by parameter <a href="#">19.01</a> ). |
| <a href="#">51.01 FBA A type</a>          | 1 = FPBA <sup>1)</sup>     | Displays the type of the fieldbus adapter module.   |
| 51.02 Node address                        | 3 <sup>2)</sup>            | Defines the PROFIBUS node address of the fieldbus adapter module.   |
| 51.03 Baud rate                           | 12000 <sup>1)</sup>        | Displays the current baud rate on the PROFIBUS network in kbit/s.   |
| 51.04 MSG type                            | 1 = PPO1 <sup>1)</sup>     | Displays the telegram type selected by the PLC configuration tool.  |
| 51.05 Profile                             | 0 = PROFIdrive             | Selects the Control word according to the PROFIdrive profile (speed control mode).  |
| 51.07 RPBA mode                           | 0 = Disabled               | Disables the RPBA emulation mode.   |
| 52.01 FBA data in1                        | 4 = SW 16bit <sup>1)</sup> | Status word   |
| 52.02 FBA data in2                        | 5 = Act1 16bit             | Actual value 1  |
| 52.03 FBA data in3                        | 01.07 <sup>2)</sup>        | Motor current   |
| 52.05 FBA data in5                        | 01.11 <sup>2)</sup>        | DC voltage  |
| 53.01 FBA data out1                       | 1 = CW 16bit <sup>1)</sup> | Control word  |
| 53.02 FBA data out2                       | 2 = Ref1 16bit             | Reference 1 (speed)   |

| Drive parameter                      | Setting for ACS880 drives | Description   |
|--------------------------------------|---------------------------|---|
| 53.03 FBA data out3                  | 23.12 <sup>2)</sup>       | Acceleration time 1   |
| 53.05 FBA data out5                  | 23.13 <sup>2)</sup>       | Deceleration time 1   |
| <i>51.27 FBA A par refresh</i>       | <b>1 = Refresh</b>        | Validates the configuration parameter settings.   |
| <i>19.12 Ext1 control mode</i>       | <b>2 = Speed</b>          | Selects speed control as the control mode 1 for external control location EXT1.                             |
| <i>20.01 Ext1 commands</i>           | <b>12 = Fieldbus A</b>    | Selects fieldbus adapter A as the source of the start and stop commands for external control location EXT1. |
| <i>20.02 Ext1 start trigger type</i> | <b>1 = Level</b>          | Selects a level-triggered start signal for external control location EXT1.                                  |
| <i>22.11 Speed ref1 source</i>       | <b>4 = FB A ref1</b>      | Selects fieldbus A reference 1 as the source for speed reference 1.   |

1) Read-only or automatically detected/set

2) Example

The start sequence for the parameter example above is given below.

Control word

- after power-on, fault or emergency stop:
  - 476h (1142 decimal) → NOT READY TO SWITCH ON
- in normal operation:
  - 477h (1143 decimal) → READY TO SWITCH ON (stopped)
  - 47Fh (1151 decimal) → OPERATING (running)



# Control chain diagrams

---

## What this chapter contains

The chapter presents the reference chains of the drive. The control chain diagrams can be used to trace how parameters interact and where parameters have an effect within the drive parameter system.

For a more general diagram, see section [Operating modes of the drive](#) (page 22).

---

# Speed reference source selection I

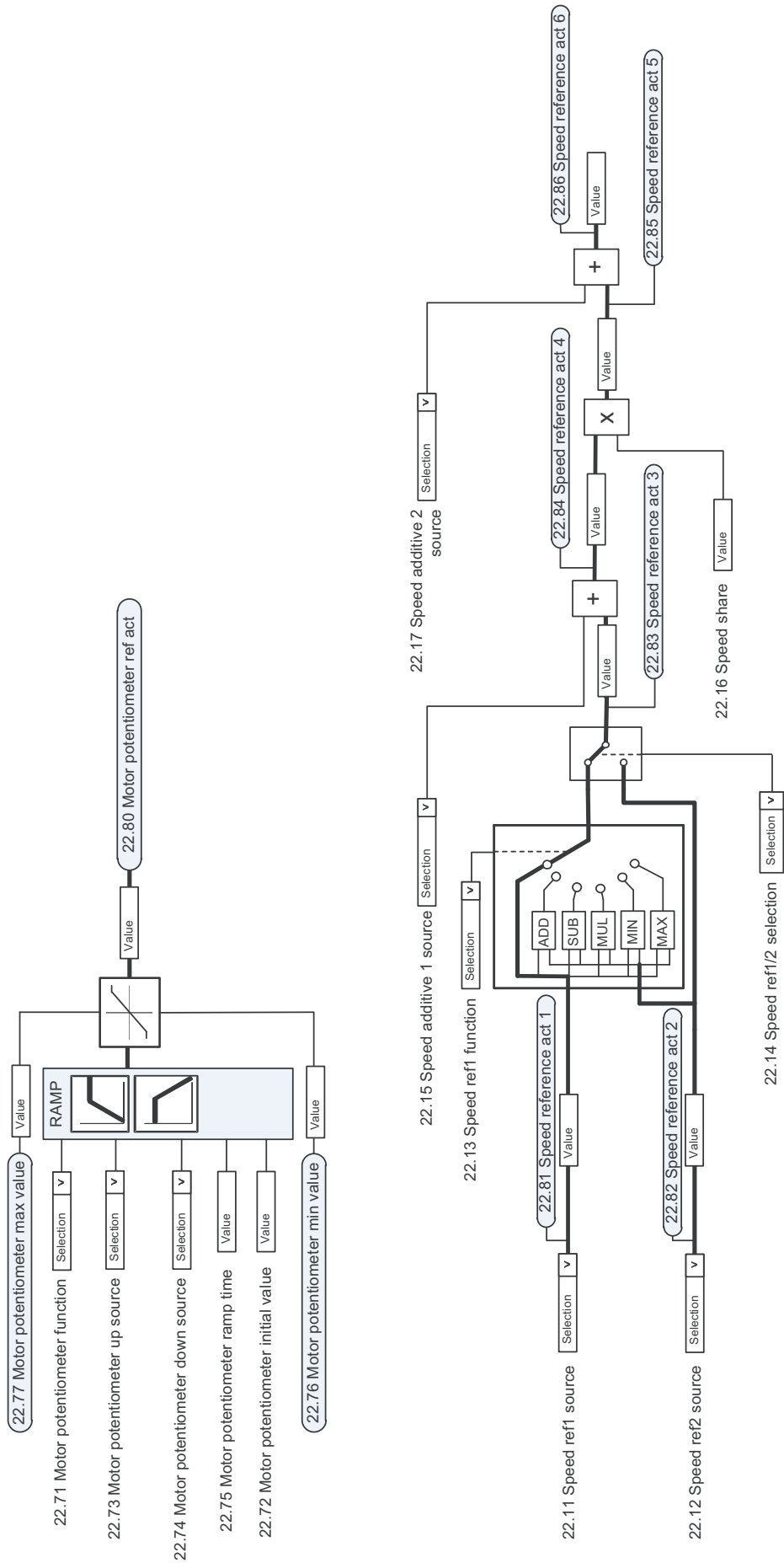

# Speed reference source selection II

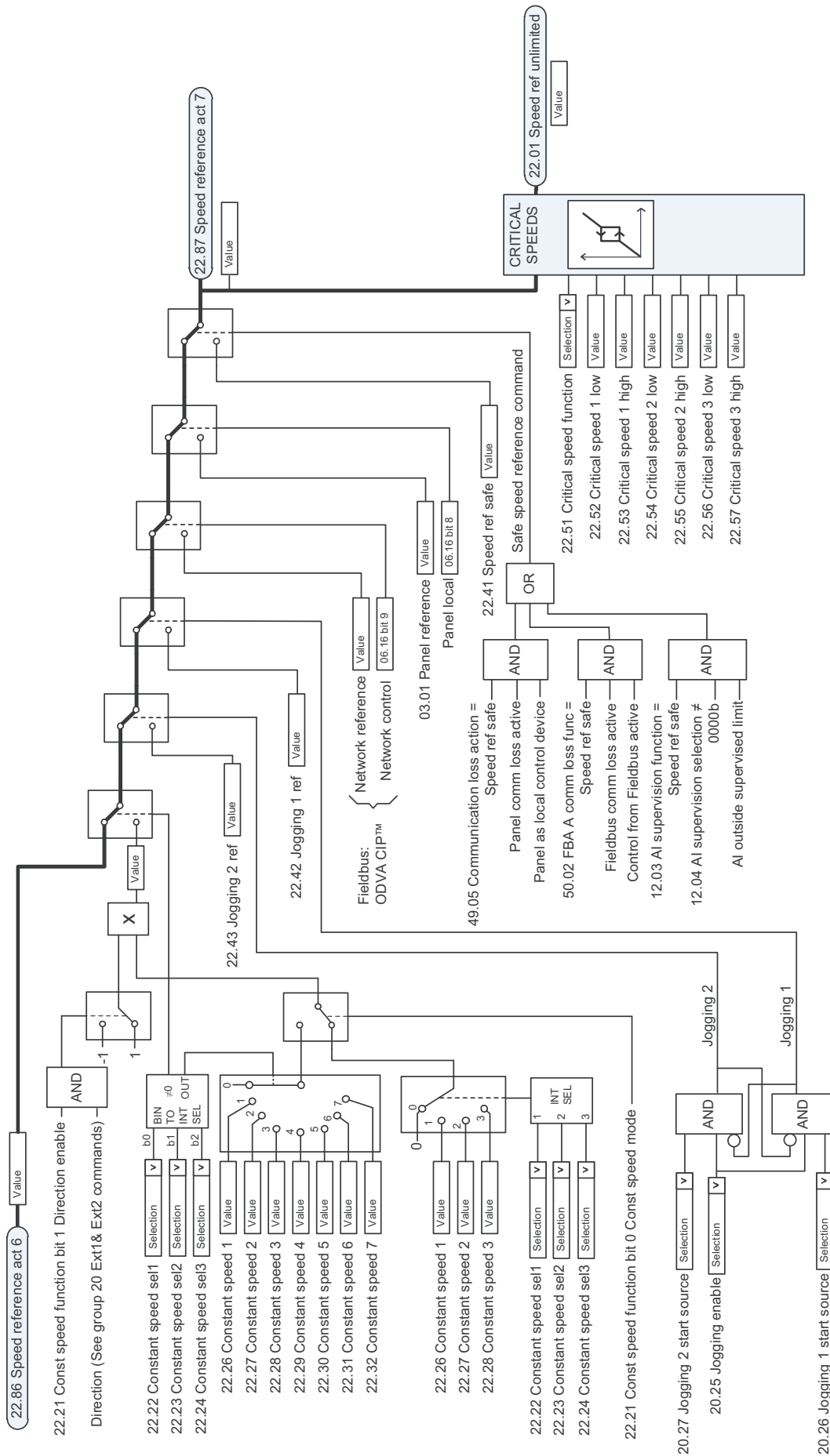

# Speed reference ramping and shaping

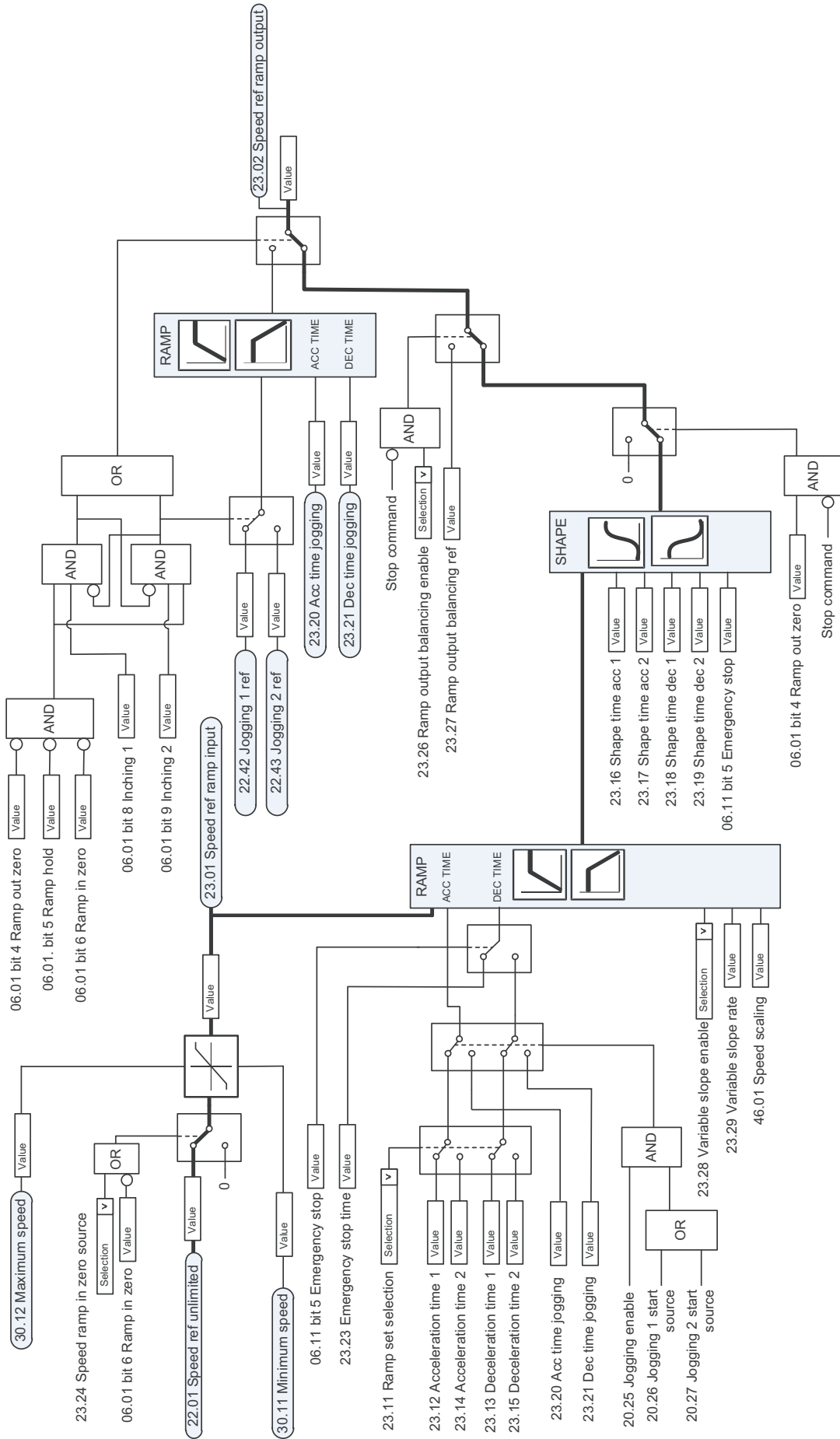

# Motor feedback configuration

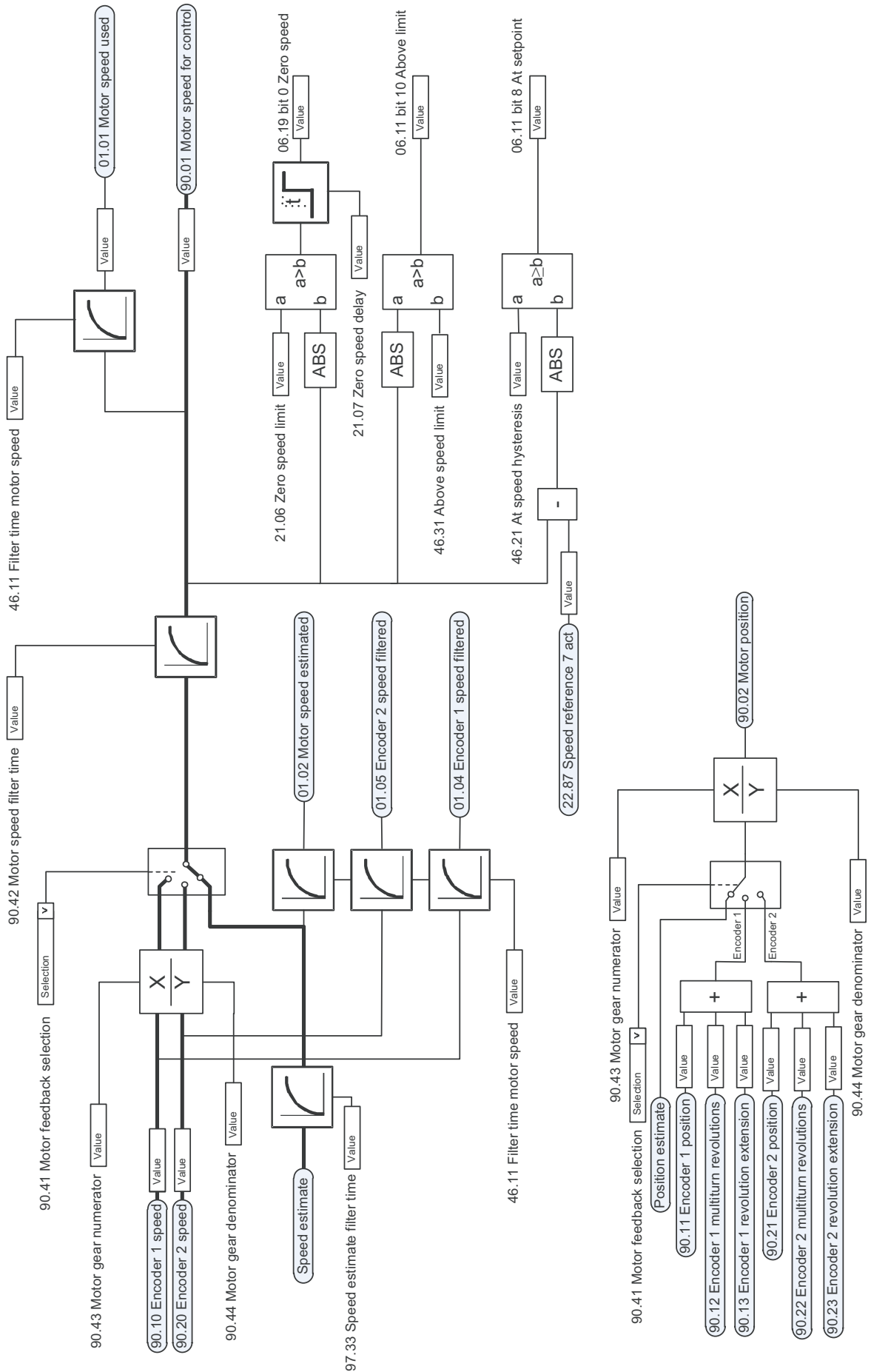

# Load feedback and position counter configuration

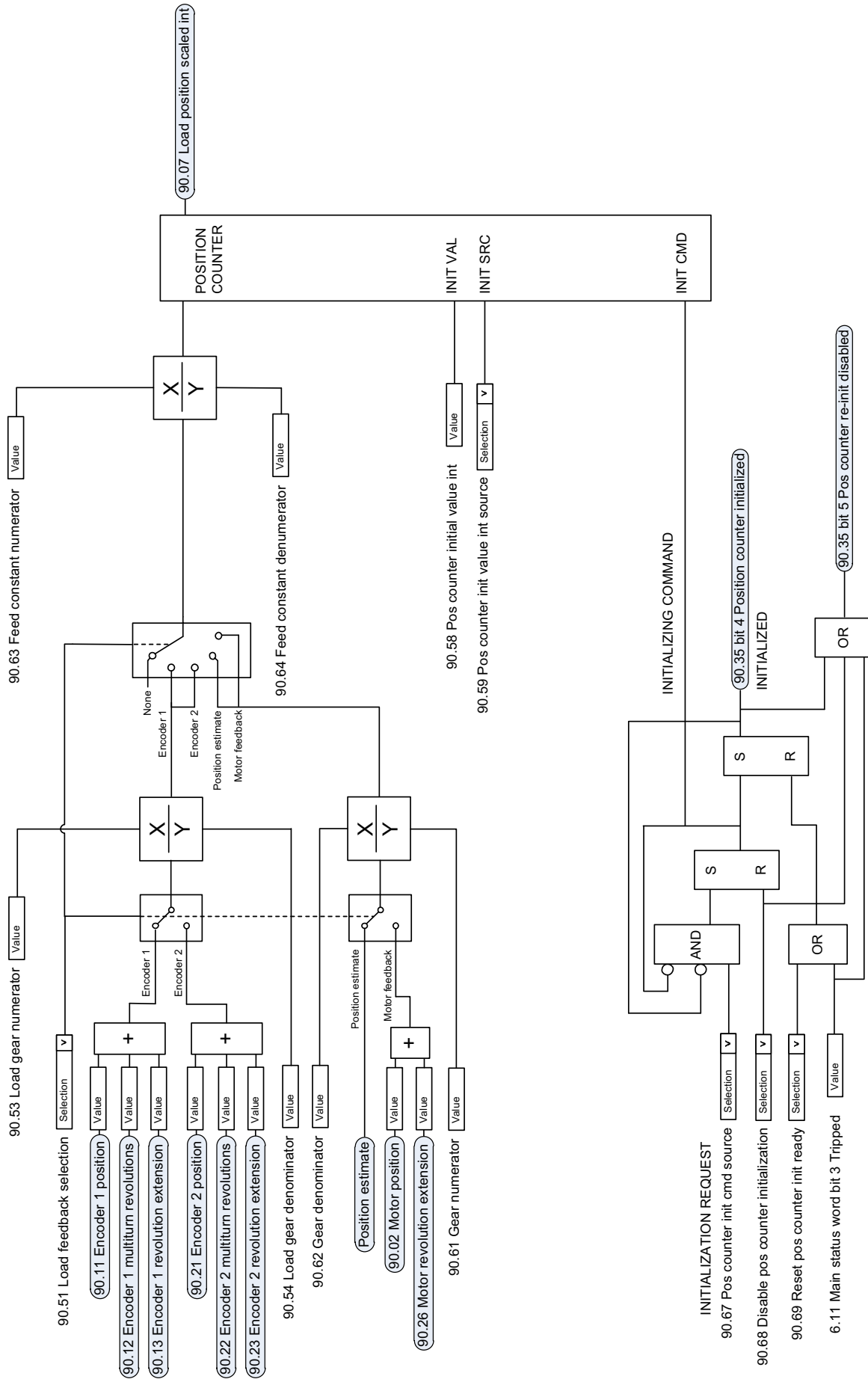



# Speed error calculation

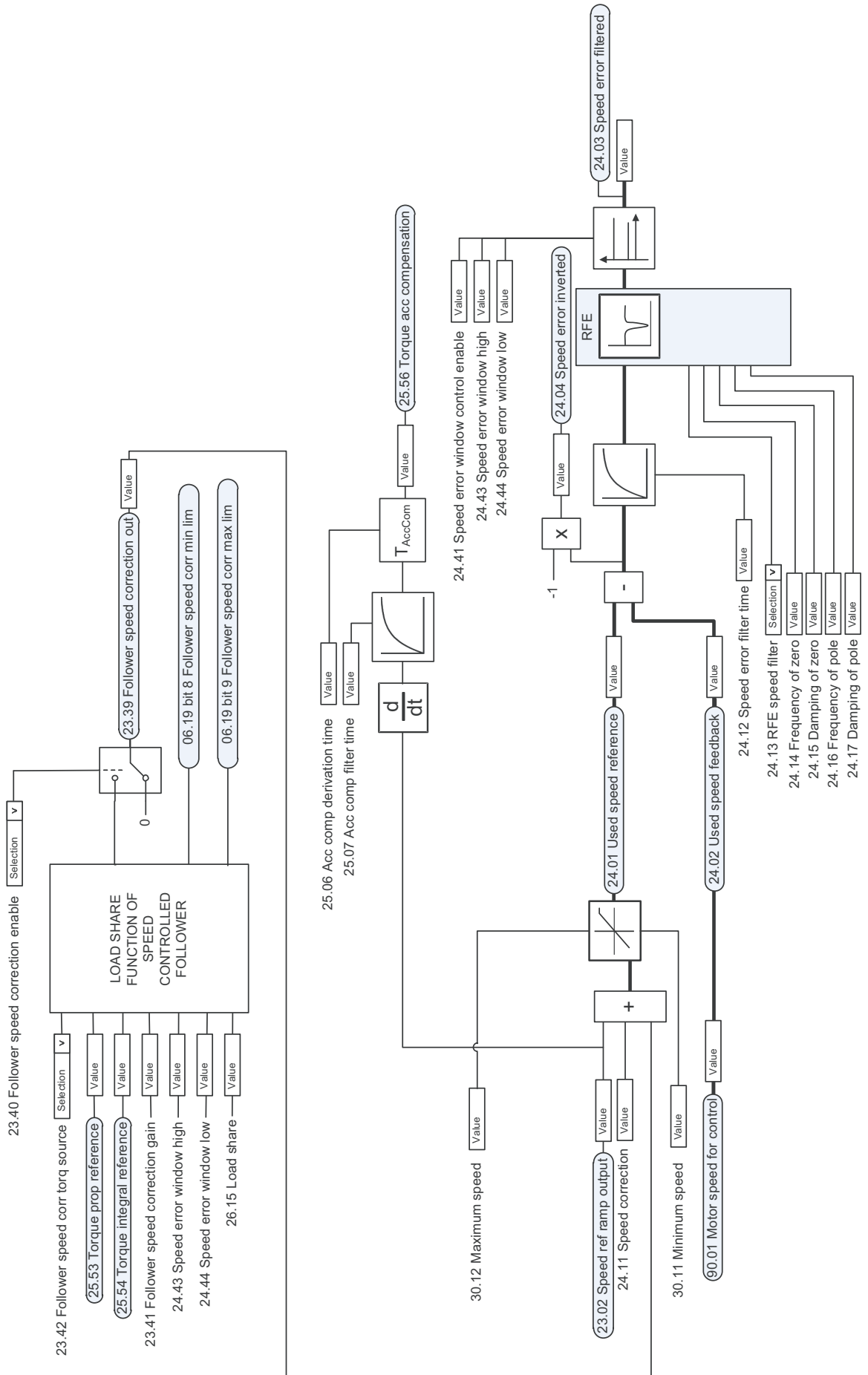

# Speed controller

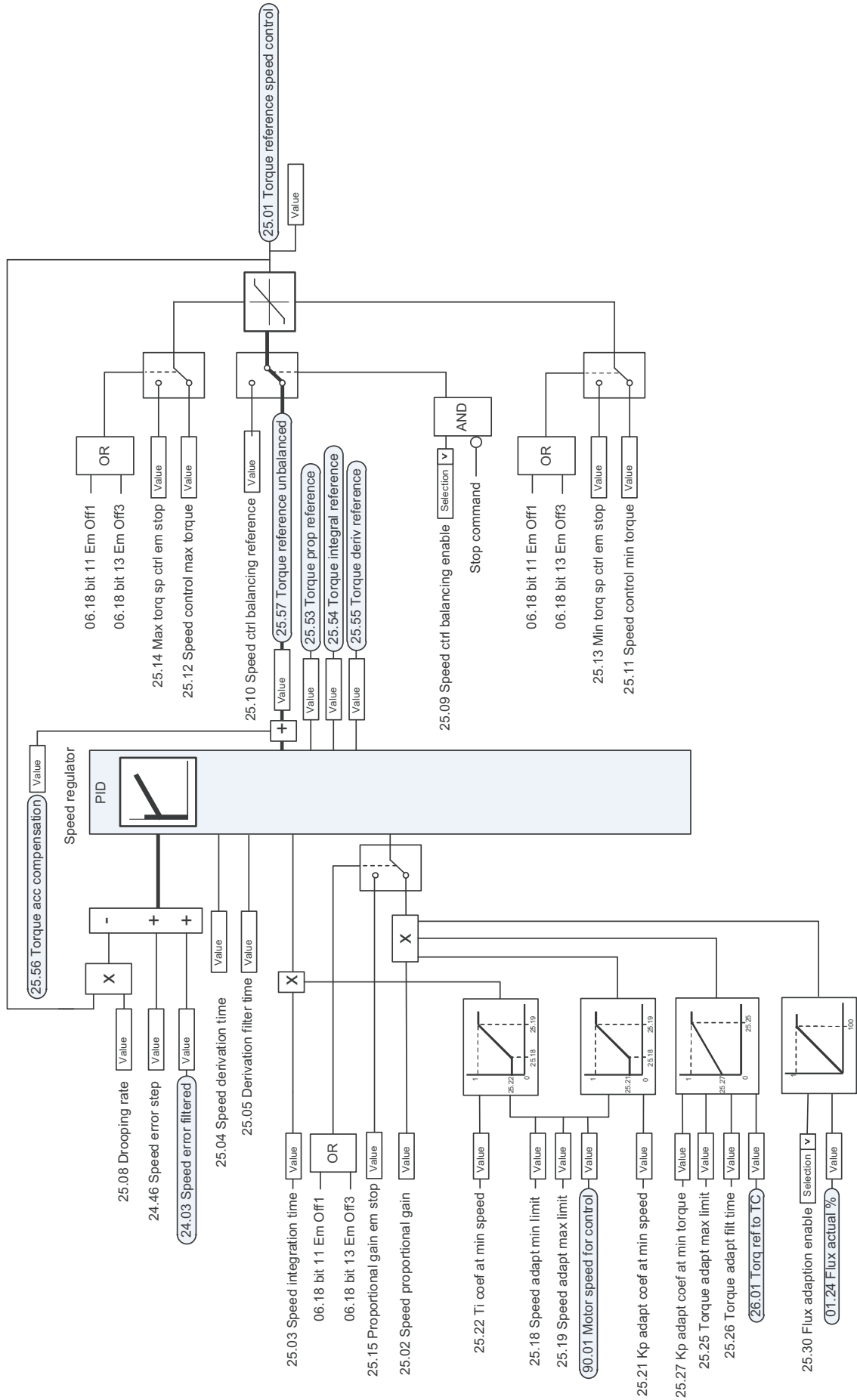

# Torque reference source selection and modification

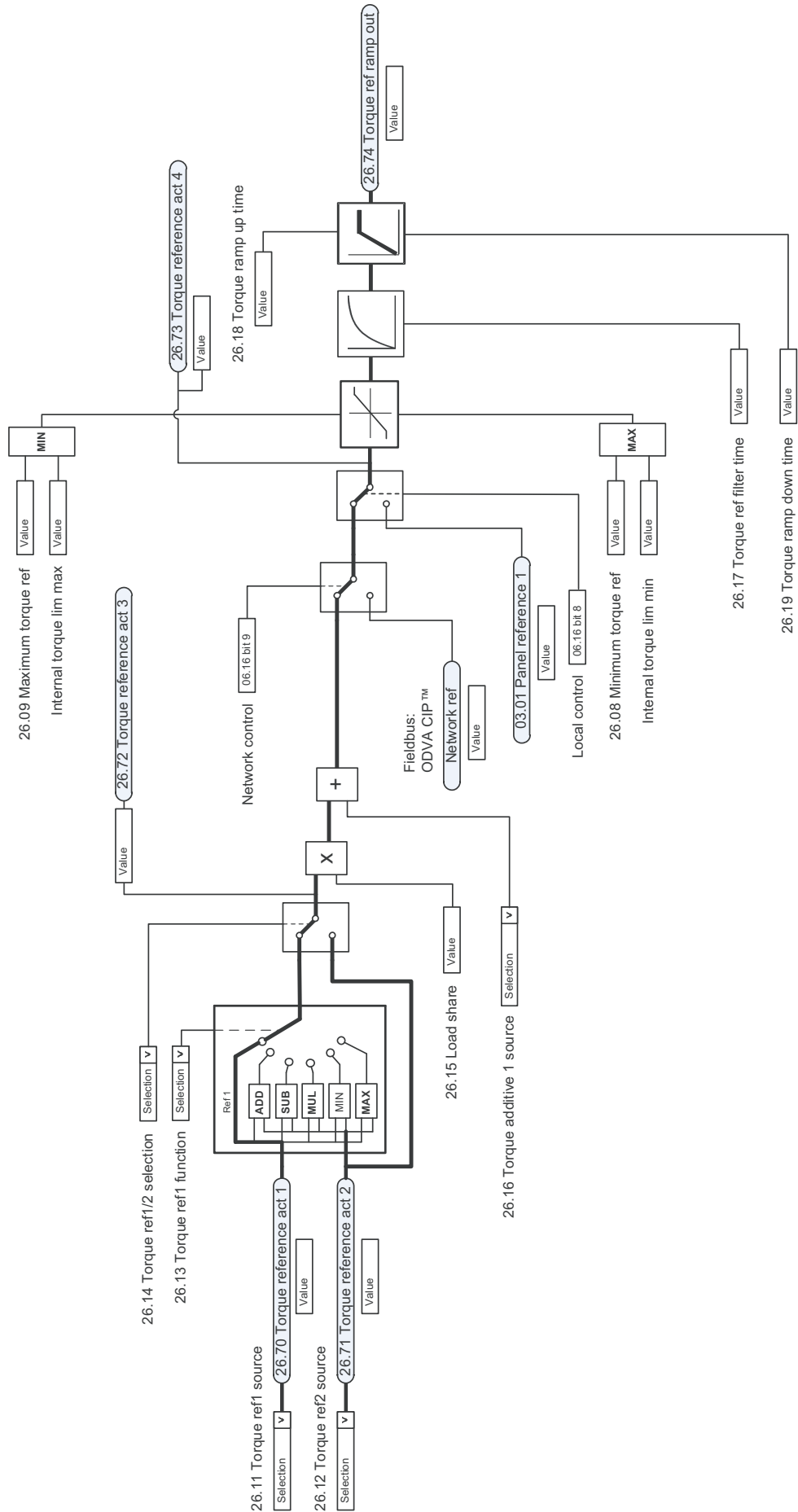

# Operating mode selection

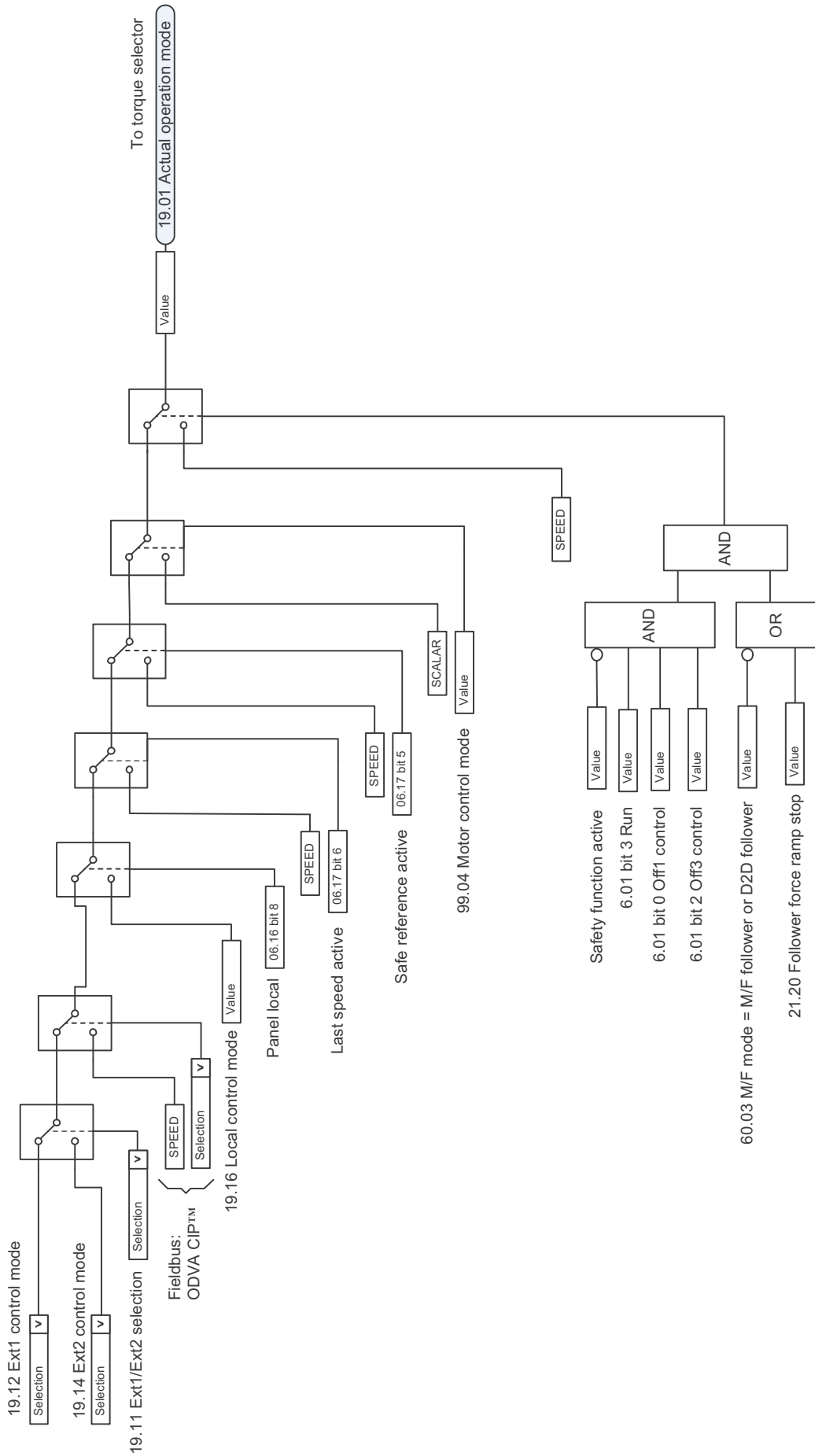

# Reference selection for torque controller

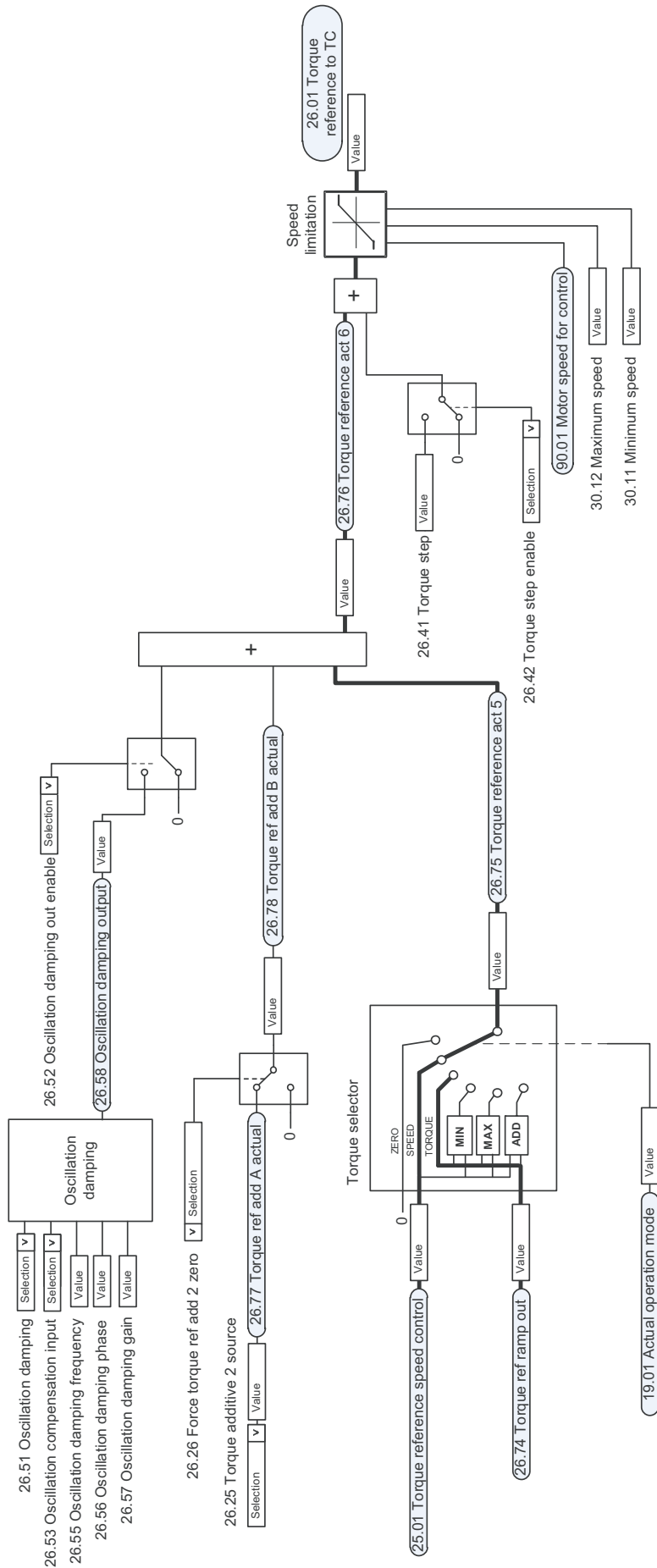

# Torque limitation

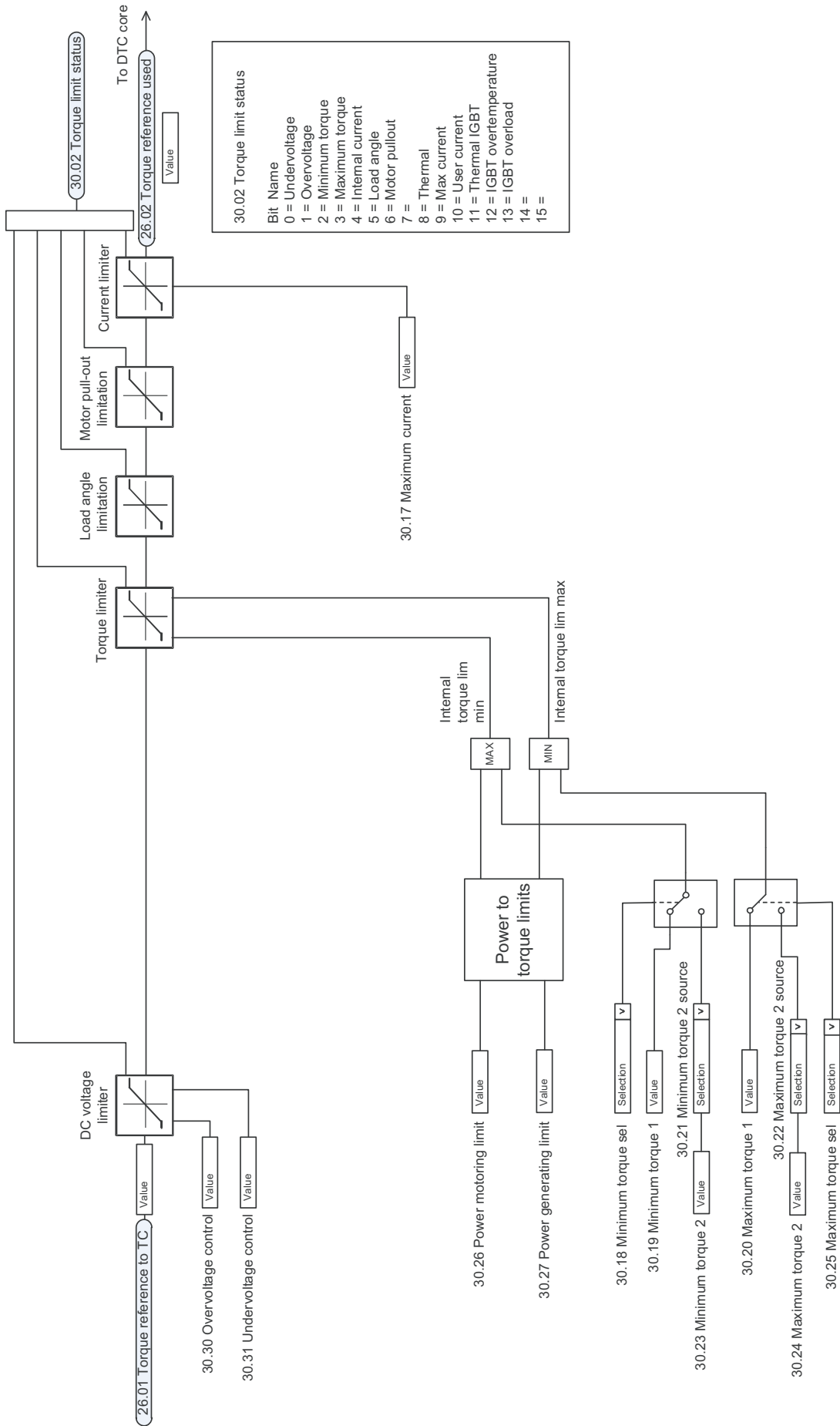

# Torque controller

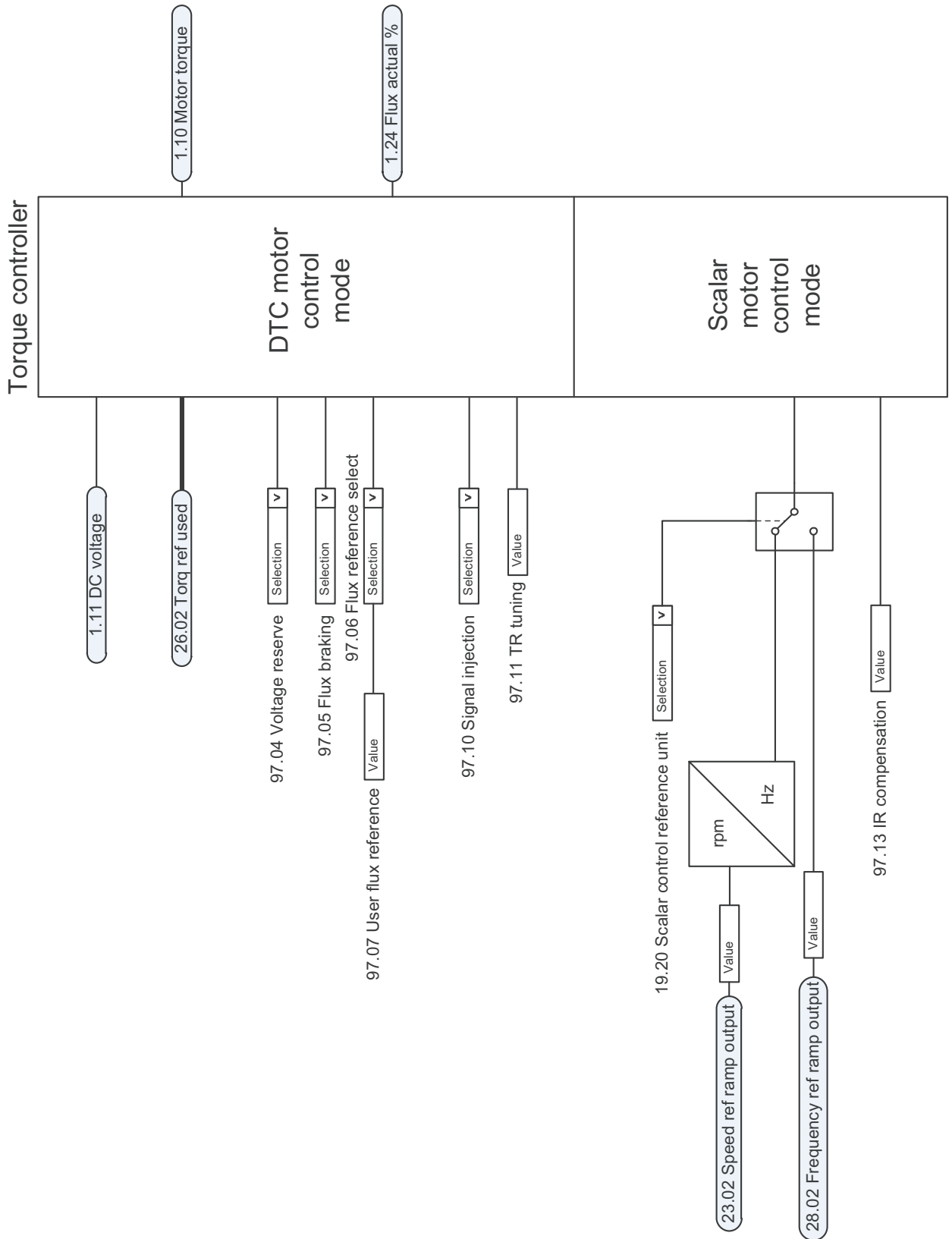





# Frequency reference modification

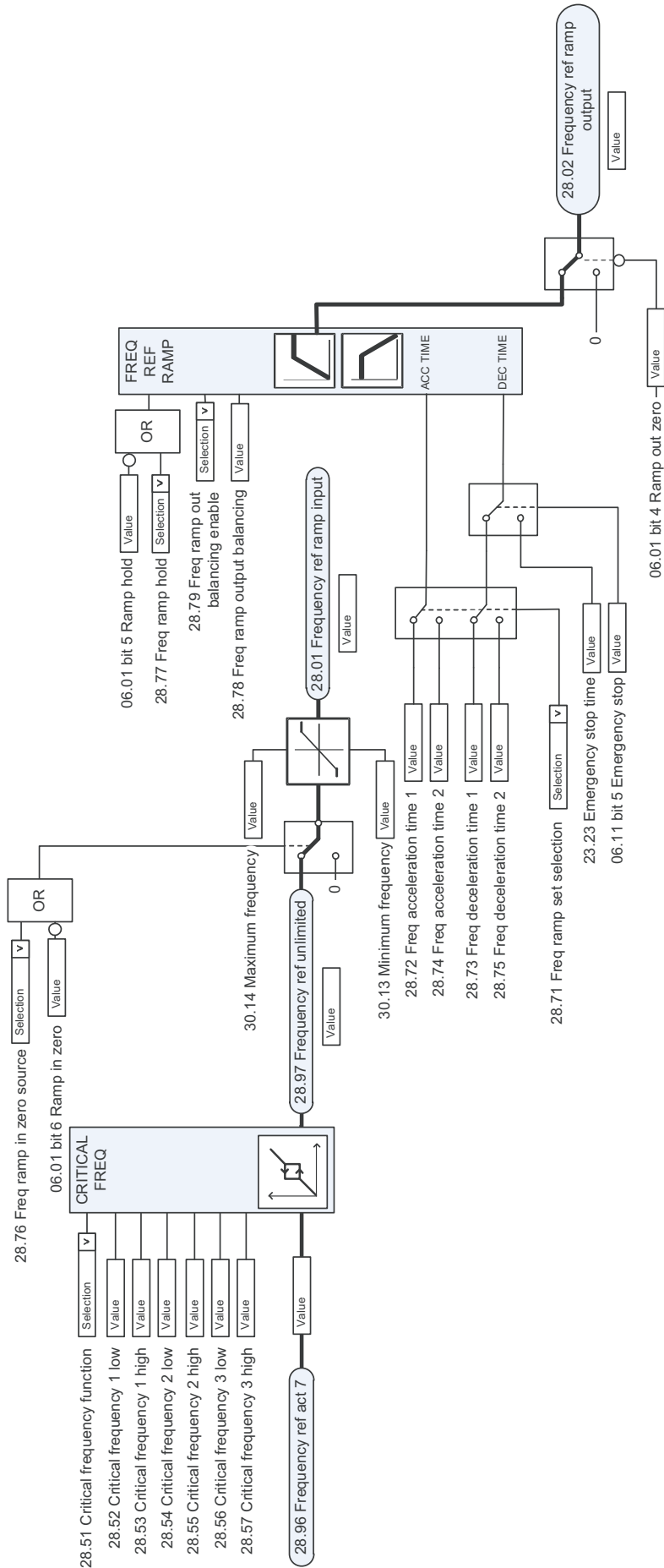

# Process PID setpoint and feedback source selection

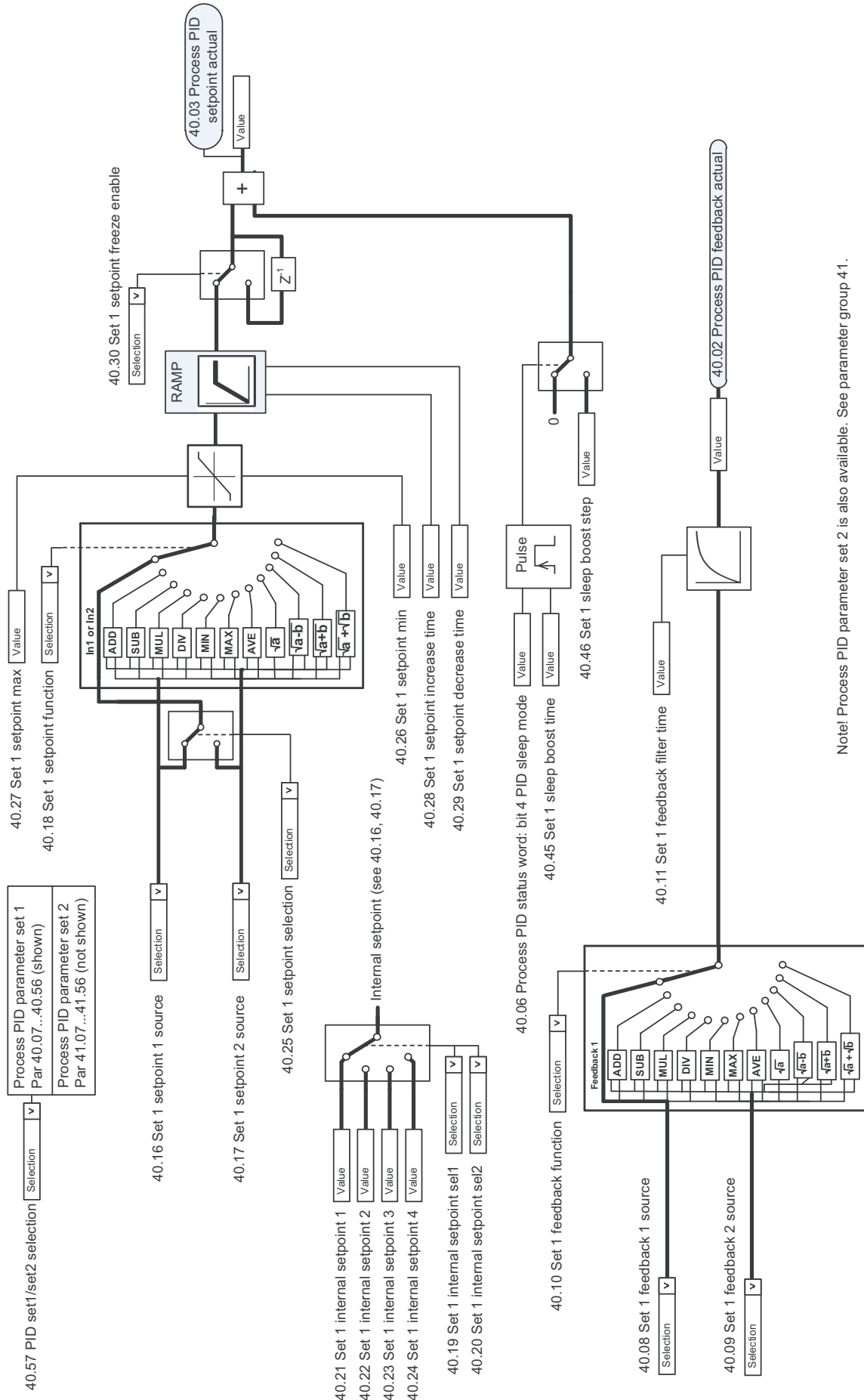

Note! Process PID parameter set 2 is also available. See parameter group 41.

# Process PID controller

## TRIM FUNCTION

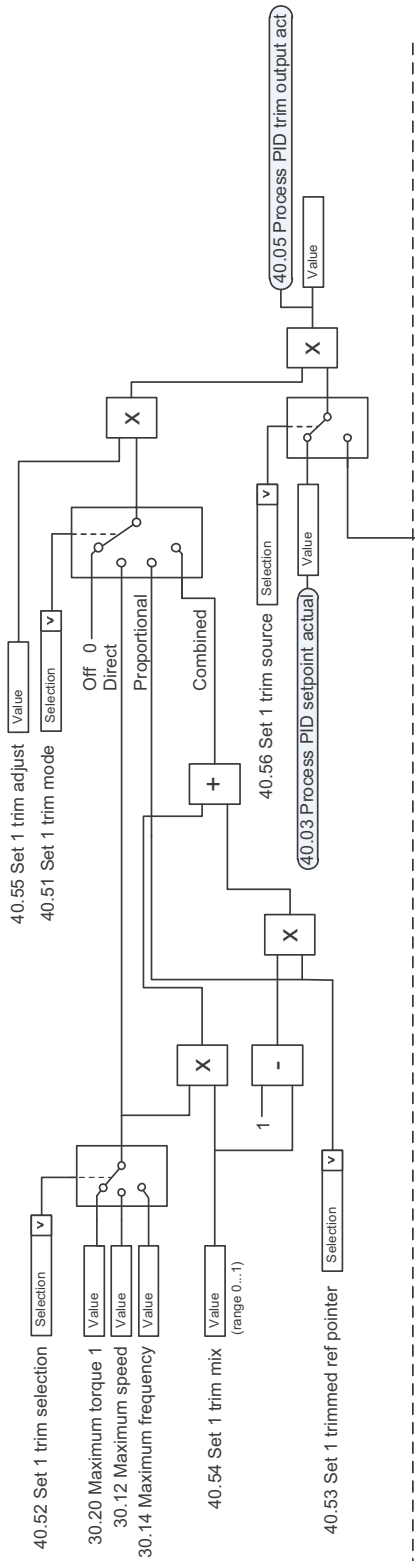

## PROCESS PID FUNCTION

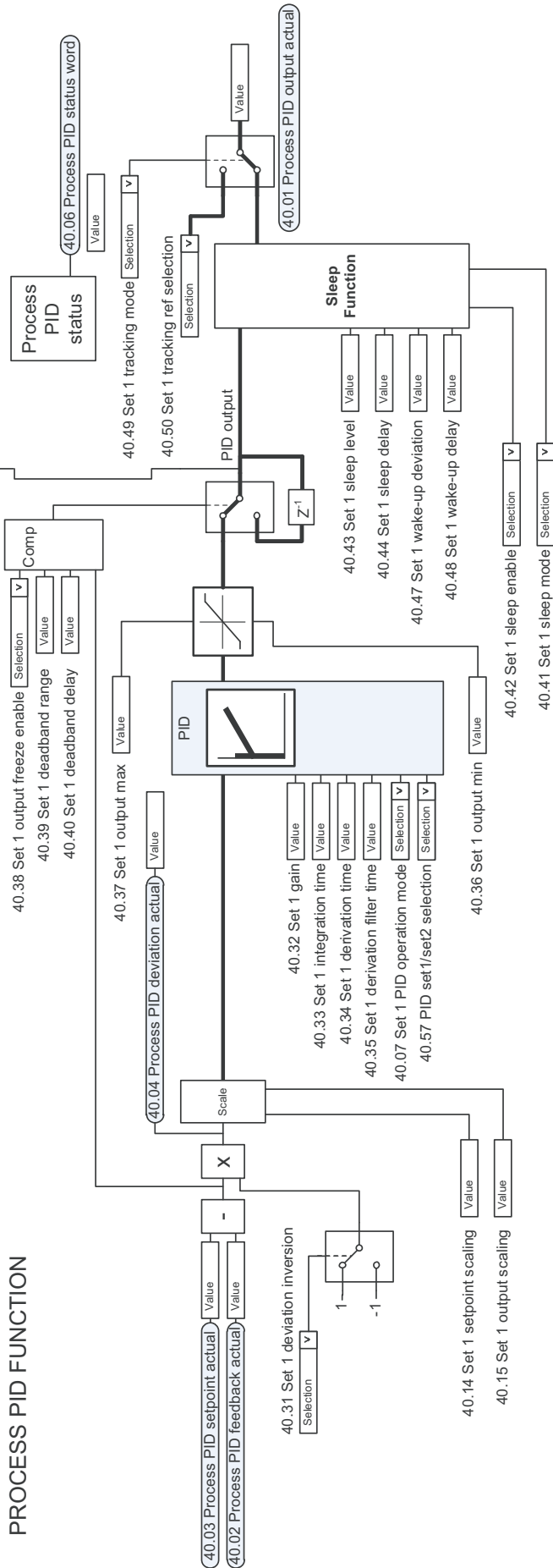

Note! Process PID parameter set 2 is also available. See parameter group 41.

# Master/Follower communication I (Master)

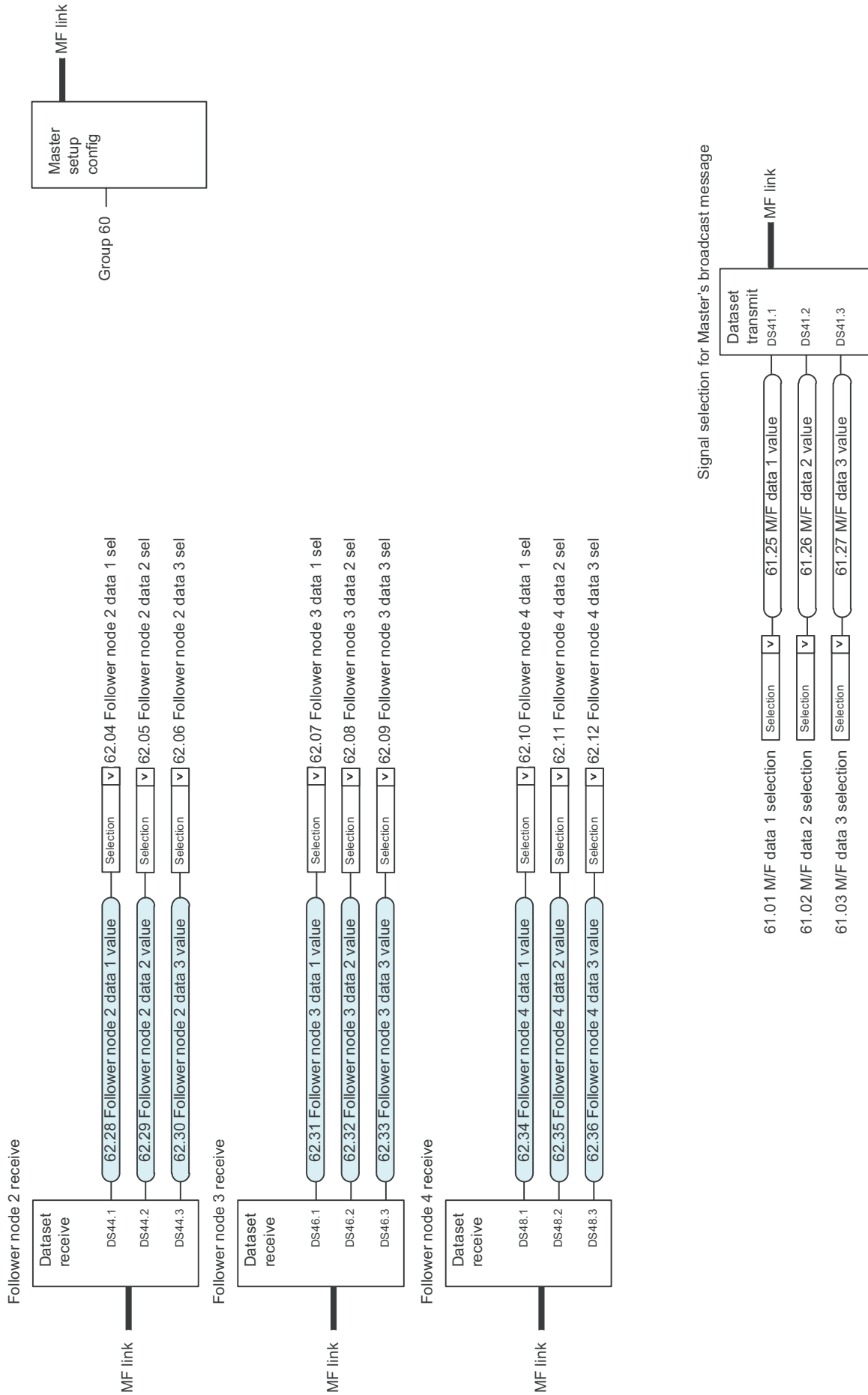

# Master/Follower communication II (Follower)

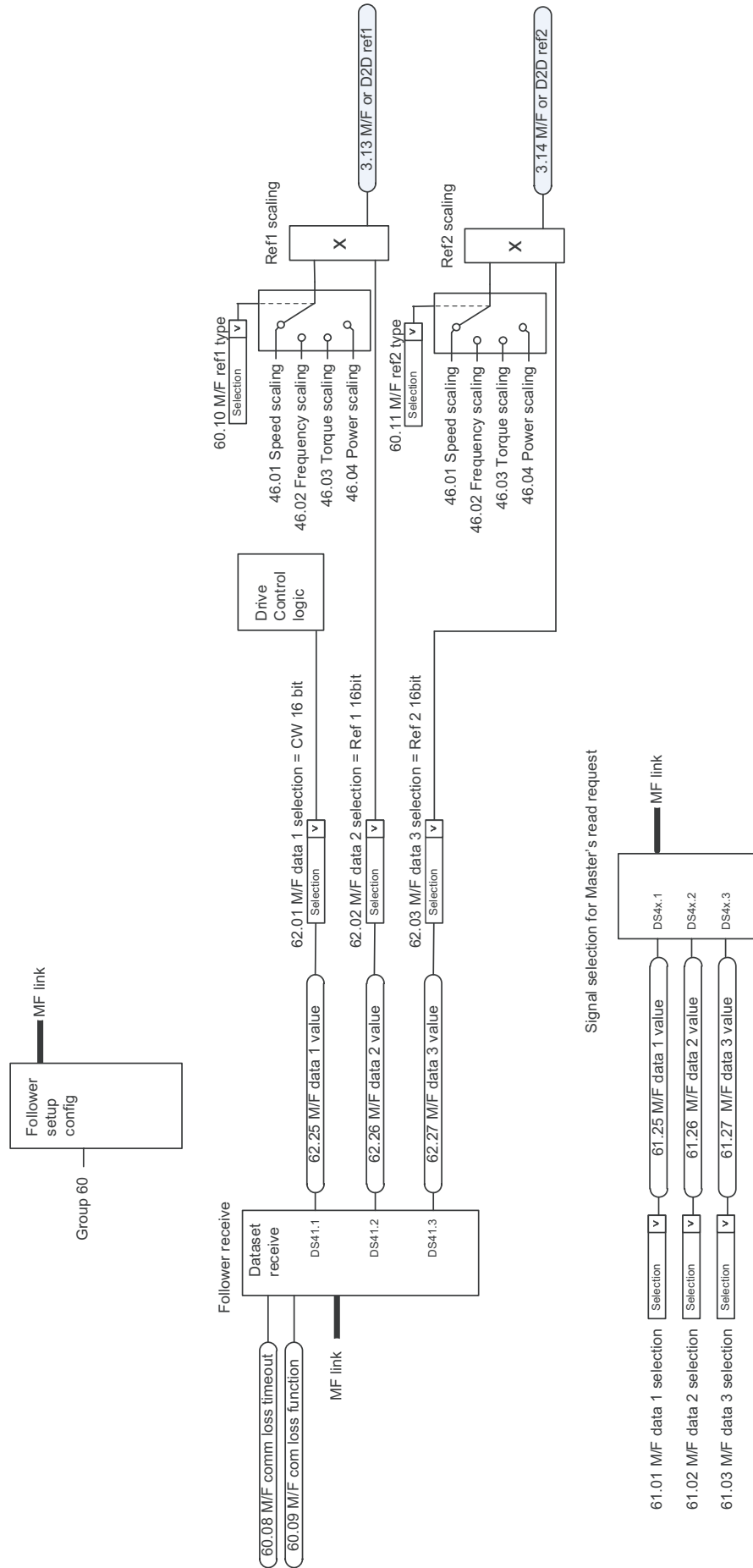



## Further information

### Product and service inquiries

Address any inquiries about the product to your local ABB representative, quoting the type designation and serial number of the unit in question. A listing of ABB sales, support and service contacts can be found by navigating to [www.abb.com/searchchannels](http://www.abb.com/searchchannels).

### Product training

For information on ABB product training, navigate to [new.abb.com/service/training](http://new.abb.com/service/training).

### Providing feedback on ABB Drives manuals

Your comments on our manuals are welcome. Navigate to [new.abb.com/drives/manuals-feedback-form](http://new.abb.com/drives/manuals-feedback-form).

### Document library on the Internet

You can find manuals and other product documents in PDF format on the Internet at [www.abb.com/drives/documents](http://www.abb.com/drives/documents).

# Contact us

[www.abb.com/drives](http://www.abb.com/drives)

[www.abb.com/drivespartners](http://www.abb.com/drivespartners)

3AUA0000085967 Rev R (EN) EFFECTIVE: 2017-07-11